

# GIRA



Gira  
System 3000  
Lighting and  
Blind Control



03	Lighting and blind control
04	Impressions
06	Installation
08	Intuitive operation
10	Gira design lines
12	Blind control // The concept
14	Lighting control // The concept
16	Lighting control // Motion detector
18	Control // Gira app
19	Control // Blind timer and timer Display
20	Lighting control // Dimming
22	Control options
24	Function overview
26	Technical data
30	Technical data of Kompakt dimmers
32	Impressions
34	Range overview



# Company

We take responsibility for the future



## Family-run since 1905

Right from the beginning, Gira and the Giersiepen founding family felt an obligation to actively take responsibility for shaping the future, through thoughts and actions. Sustainable conduct and business practices are the key – to the benefit of the environment, people and the economy. This is true to Gira's heart and expresses the inner attitude of the company and of its employees. And it is an ongoing task to which everyone at Gira is devoted, each and every day. This pronounced willingness to take responsibility stems from a company culture and values that have developed over the course of 113 years and that count on commitment, predictability, mutual respect and partnership in the company's interaction with market partners and employees.

## Thinking and acting sustainably

This is also the starting point for Gira's sustainability strategy. The objective of the strategy is to shape all processes and the organisation, so that they fulfil economic, environmental and social priorities – inside and outside of our own factory. Accordingly, Gira invests in the continuous improvement of its environmental footprint and in the responsible handling of resources. And in the development of products and

solutions that are particularly environmentally friendly throughout their entire life cycle. Material recycling in plastic production, a range of switches made from natural, environmentally-compatible yet durable materials, fundamental optimisation of energy efficiency of products and buildings, active health management for the employees – Gira has already achieved a lot on the way to reaching the targets that it has set itself.

## Future technology "Made in Germany"

Gira's repeated success on the market with pioneering achievements, innovative solutions and exciting applications is due at least in part to the extraordinary technological know-how and inventive spirit of its employees. More than 130 engineers in a range of disciplines from software specialists to mechanical engineers ensure a high level of innovation in product development and manufacturing. Gira products and solutions stand for the extremely high quality requirements associated with the label "Made in Germany": German engineering skills and excellent workmanship. Accordingly, Gira products win over users with their high manufacturing quality, their reliability, safety and durability. As well as their timeless aesthetic appeal and elegance.

## Award-winning design

From the beginning, Gira has not only attached particular importance to ensuring the highest levels of functionality and reliability for the products, but also invests in giving them pleasing, trend-setting designs. However, Gira does not view having "well-formed" products and solutions as an end in itself. Instead the form is developed from the interaction of design, function, technical innovation and emotion. The numerous prestigious international awards received by Gira products and solutions – such as the "iF Award", the "Red Dot Award" and the "German Design Award" – are testaments to the exceptional design quality. And the ability to make design and function simply come alive.

Member of the  
KNX Association and CEDIA

As a member of the KNX Association and CEDIA, Gira ensures that its products and solutions meet international standards that are not tied to a particular manufacturer.

Experiencing Gira live

In the Gira studios, the interaction of home entertainment and intelligent building technology can be experienced live. Experts such as system integrators and audio specialists collaborate to present the latest innovations in building technology and multimedia with integrated functionalities.

In the other showrooms, there is an application-oriented presentation of Gira products in combination with technology for other fields including sanitary, heating, air conditioning or ventilation applications. The products are also presented integrated in diverse living spaces, for example in upscale furniture stores.

You can find Gira showrooms in your area here:  
[www.gira.com/showrooms](http://www.gira.com/showrooms)



CEDIA MEMBER

RIBA 

## Lighting and blind control made easy

//

The Gira System 3000 offers maximum flexibility and optimum convenience for advanced lighting and blind control: With five different operating top units, which can be universally used both for lights and blinds, this offers easy operation and a functional and aesthetically pleasing solution for every desired level of comfort. The top units are distinguished by their intuitive operation. Even the simplest operating top units store an individual intermediate position. The functions of the Memory and Display devices range from simple time control to comprehensive control options with the blind timer and timer Bluetooth. Simple settings are made directly on the device without any tools, while comprehensive programming is carried out easily and conveniently with the Gira app using a smartphone or tablet. The motion detectors for automatic lighting control can also be operated in the same way in the System 3000.

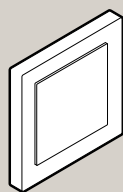

Operating top unit

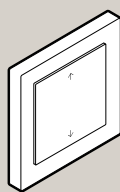

Operating top unit arrow symbols

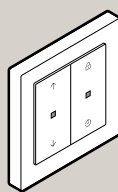

Operating top unit Memory



Blind timer and timer Display

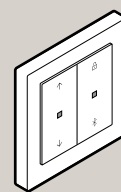

Blind timer and timer Bluetooth

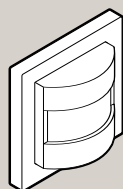

Motion detector 1.10 m Standard



Motion detector 1.10 m Komfort Bluetooth

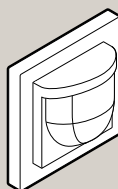

Motion detector 2.20 m Standard



Motion detector 2.20 m Komfort Bluetooth

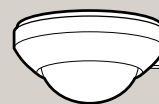

Presence and motion detector 360° Bluetooth



Gira System 3000 blind control, operating top unit arrow symbols  
Design line: Gira E2, anthracite



Gira System 3000 blind control, operating top unit Memory  
Design line Gira E3, pure white glossy



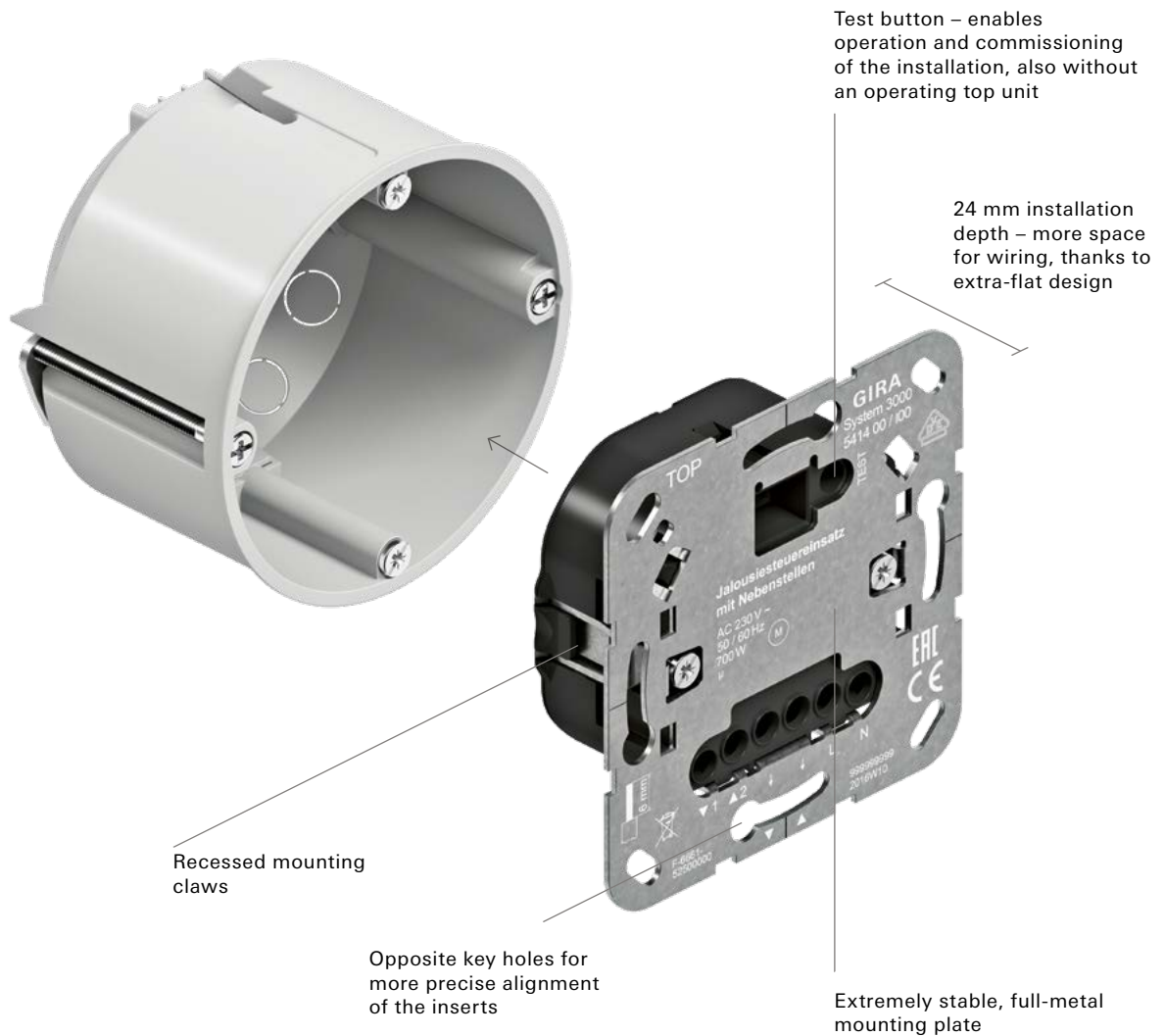

Structure

- [01] Gira System 3000 control insert
- [02] Gira frame range
- [03] Gira System 3000 operating top unit

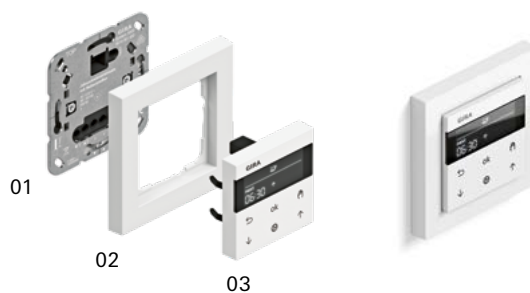



## Simple and flexible installation

//

Installing the new-generation lighting and blind control inserts is now even easier. With an extra-flat installation depth of just 24 millimetres, the new inserts leave more space in the flush-mounted box, which means greater wiring flexibility. Recessed mounting claws make for easier installation and provide increased safety. Start-up of installed inserts can be done without an operating top unit, using a test button to check their function. Depending on the operating top unit, the standby power is just 0.2 W – 0.5 W.

### Light control inserts

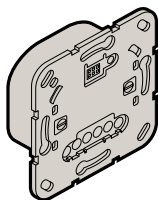

---

Universal LED rotary dimming insert  
Standard

.....  
Universal LED dimming insert Komfort

.....  
Flush-mounted DALI power control unit  
insert

.....  
Relay switching insert

.....  
Electronic switching insert

.....  
Impulse insert

.....  
Auxiliary insert, 2-wire

.....  
Auxiliary insert, 3-wire

### Blind control inserts

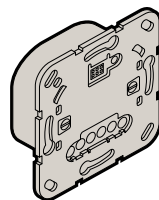

---

Control insert with auxiliary input

.....  
Control insert without auxiliary input

## Intuitive operation and programming

//

Regardless of whether you choose the Bluetooth top unit with app control or the display device, it is easy to operate the device and program your own settings. Besides controlling the desired lighting switching or movement times manually, you can save the current time to program the times for all seven days. Alternatively, you can easily differentiate between weekdays and weekend. Especially convenient: The integrated astro function makes it possible to dynamically match the desired activation times to sunrise and sunset. The changeover between summer and winter time is carried out automatically.

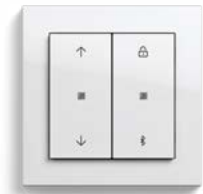

The ultimate in convenience:  
Control via app

Conveniently program and control everything as you need it, from the comfort of your own sofa: The Bluetooth operating top unit takes lighting and blind control to a whole new level. The smartphone or tablet becomes the control centre. With the Gira app, you have all the settings for the various light sources, blinds and shutters displayed clearly on a large screen and perfectly under control. Time programs that have already been created can easily be copied into other operating top units.

Gira System 3000 lighting and blind control, Gira App  
The Gira App is available free of charge in the Google Play Store and Apple App Store.

All functions in one operating top unit

Touch-sensitive buttons make operating the blinds and the timer pleasant, quick and easy. The high-contrast, illuminated display also ensures that the selected settings are clearly legible. The system independently recognises on which control insert the operating element is mounted: the light or blinds insert.



Gira System 3000 blind control, blind timer and timer Display  
Design line: Gira E2, stainless steel



Gira System 3000 lighting and blind control, blind timer and timer Display  
Design line: Gira E2, stainless steel

## Award-winning design for any ambiance

//

Ten design lines, more than 75 frame variants, and more than 300 inserts in different colours and materials:

The modular Gira design system offers a great range of designs and functions to suit any taste and any ambiance. In addition to switches, socket outlets, and the numerous new Gira System 3000 lighting and blind controllers, other functions can be integrated, such as door intercoms or KNX push button sensors. For detailed information on all Gira design lines, see: [www.gira.com](http://www.gira.com)



- Gira design lines [selection]:
- [01] Gira Standard 55, pure white glossy
  - [02] Gira E2, pure white glossy
  - [03] Gira E2, stainless steel
  - [04] Gira E2 flat installation, anthracite
  - [05] Gira E3, blue-grey soft touch/anthracite
  - [06] Gira Event Clear, brown/cream white glossy
  - [07] Gira Esprit, white glass/pure white glossy
  - [08] Gira Esprit, stainless steel/anthracite
  - [09] Gira Esprit linoleum multiplex, blue/pure white glossy



## Blind control that meets your needs

//

With the Gira System 3000 blind controller, controlling the daily raising and lowering of blinds and shutters is easier than ever before. Numerous customisable functions are available and, using the Bluetooth operating top unit in combination with the Gira app, can even be controlled from your smartphone or tablet. The blind can be raised or lowered to any desired position for appropriate privacy and sun protection. Particularly practical: The integrated astro function makes it possible to dynamically match the saved movement times to sunrise and sunset. The changeover between summer and winter time is carried out automatically.









## Lighting control with a concept

//

The different Gira System 3000 operating top units offer customised convenience and make life in your home even more pleasant, safer and more economical.

Well-lit apartments or houses minimise the risk of burglaries. The Gira time control functions make sure your rooms are brightly lit even when you are not home. By preprogramming different dimmer settings, brightness levels and switch-on times for individual or several lamps, you can create a pleasant living atmosphere that meets your needs and requirements.

The Gira System 3000 gives you various options for individual lighting control: from the simple on-off switch to the extensive functions that can be conveniently controlled through the app or the Display timer.





Gira System 3000 lighting control  
Presence and motion detector 360° top unit Bluetooth

## Full functionality: Motion-triggered light

//

On. Off. All by itself. Motion detectors control the lighting in hallways and staircases, or in house entrances and driveways; this is not only convenient but also saves energy. The new Gira System 3000 motion detector with digital sensors ensures the best possible detection in a wide range of installation situations. The standard versions are suitable for basic applications and for expanding the detection zones. With the Komfort devices, many special functions can be implemented additionally. These can easily be configured via Bluetooth with the Gira app.



Standard-version motion detectors principally work with fixed parameters. The brightness threshold and sensor sensitivity can be set using potentiometers.



Komfort-version motion detectors are easily and conveniently configured via Bluetooth with a smartphone or tablet. In addition to the standard settings, they offer a wealth of additional functions: Occupancy simulation, night light, alarm mode, etc. make convenient all-round lighting control possible.



The 360° ceiling-mounted version is also equipped with the Komfort functions. Additionally, these detectors offer a choice between motion and phase detection, as well as constant lighting control: Ideal for work areas, hallways and staircases.



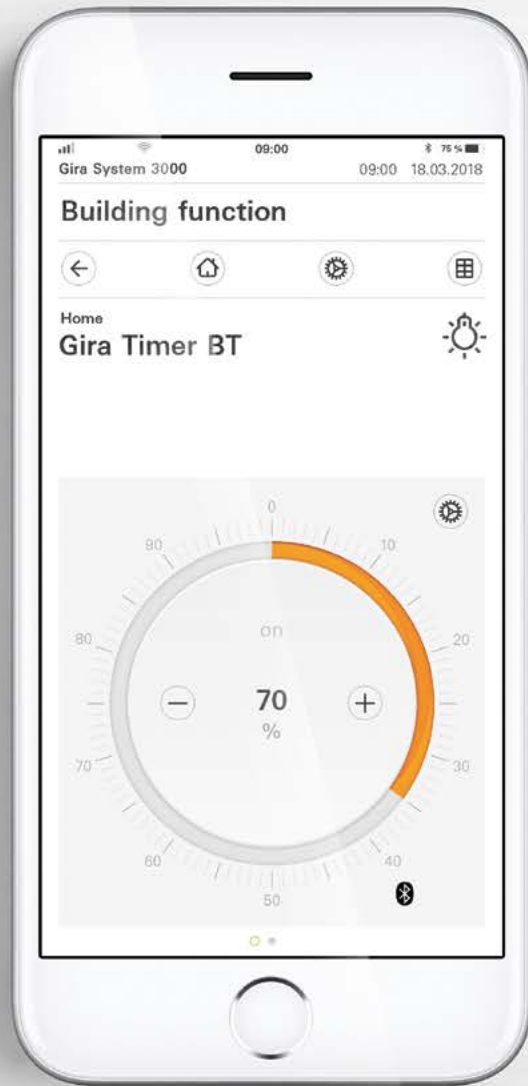



Commissioning wizard for simple device coupling

Name and configure devices individually

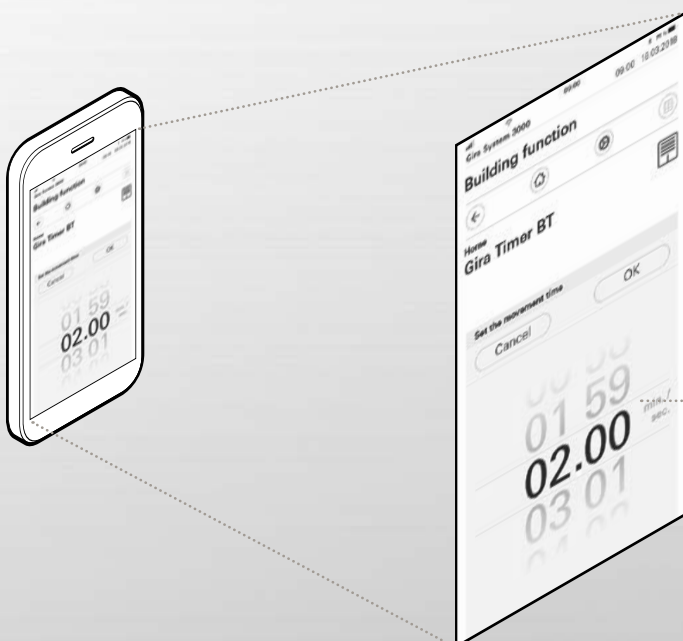

Parameters are quick and easy to configure

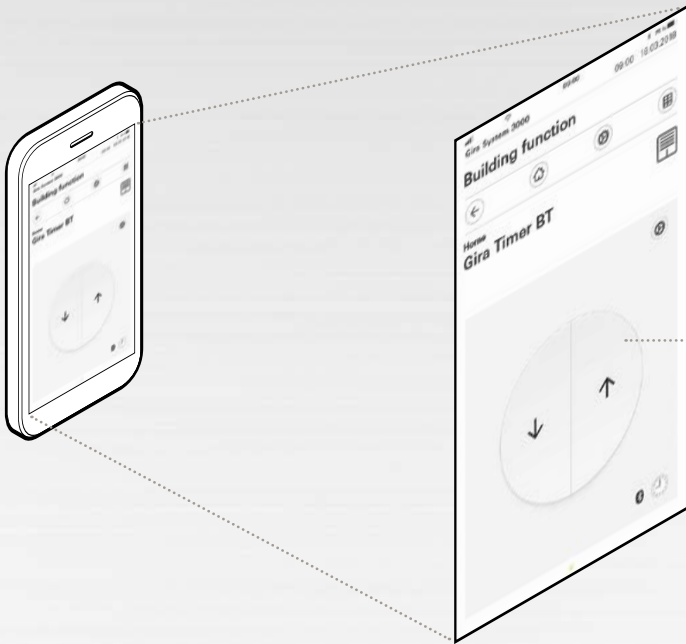

Set the position of the blind using either the control buttons or slider



Easily adjust the desired lighting mood

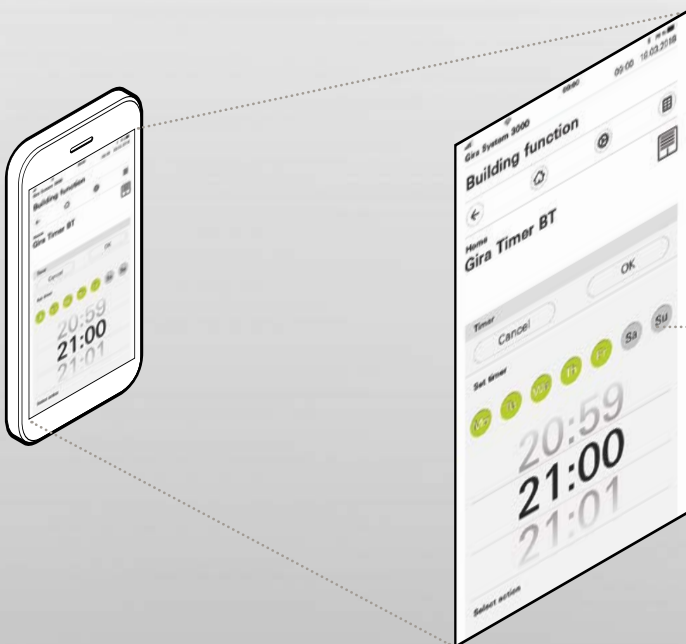

Set switching times according to your personal requirements



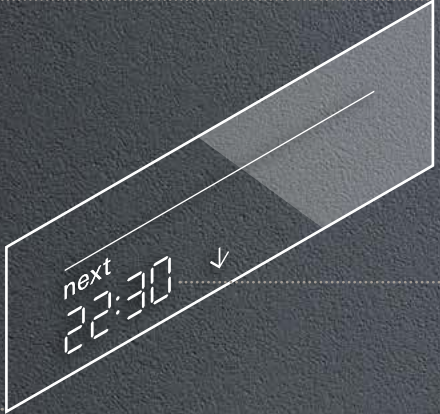



Start view:  
Time of the next action

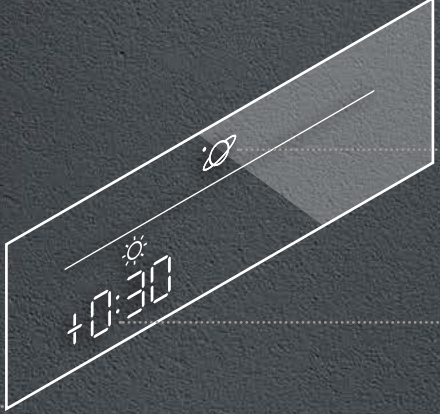
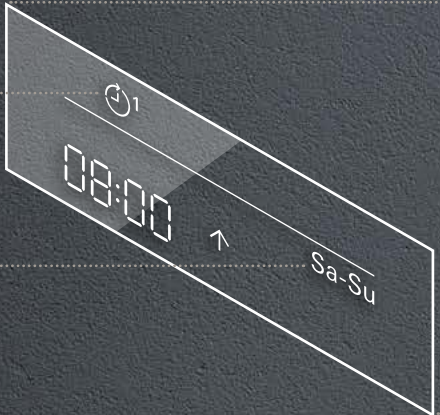

Individually programmable  
seven-day timer

Program one switch-on  
and one switch-off time (light),  
or one raising and one  
lowering time (blinds) for  
Mon-Fri and Sat-Sun



 Astro function:  
Dynamic time control  
based on sunrise and  
sunset

 Optional offset time for  
sunrise and sunset



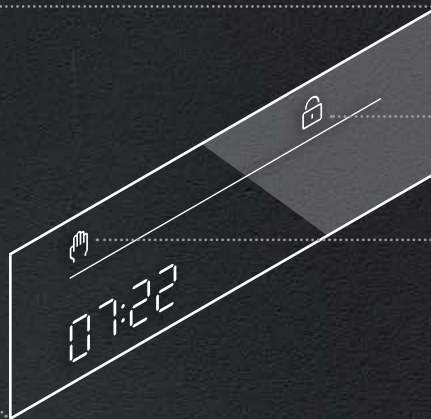
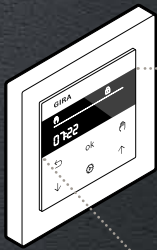

🔒  
Integrated  
blocking function

👉  
Manual control



Set time zones  
for astro times  
in 18 countries using  
the country selection

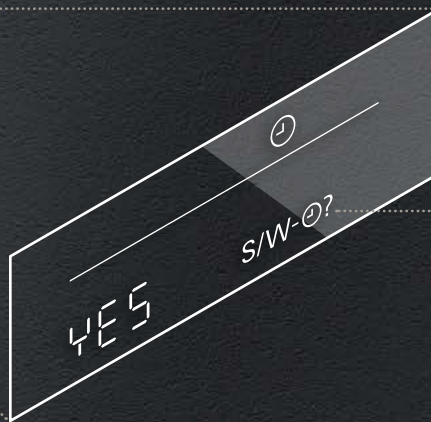
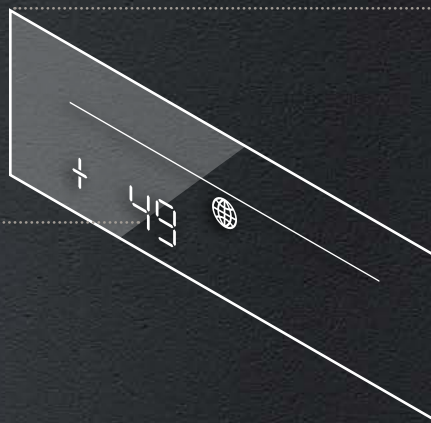

🕒  
Automatic  
summer/winter time  
switchover selectable





## Dimming lights made simple and convenient

//

With dimming inserts, the brightness of lights can be controlled to configure individual lighting moods and reduce energy consumption. For convenient lightning control, Gira offers a large range of simple rotary, touch and built-in dimmers matching the System 3000.

With the new Gira System 3000, you can switch and dim universal LED dimming inserts, light bulbs, HV halogen lamps, electronic transformers for halogen or LED lamps, as well as dimmable inductive transformers for halogen or LED lamps, HV LED or compact fluorescent lamps. They can be combined with various System 3000 operating top units and enable individual adjustment of the switch-on brightness, and, in the Komfort version, allow operation of other auxiliary units.

Technically, the Gira rotary dimmers are identical to the touch dimmer inserts and control the same loads. The difference is that they use rotary controls and are equipped with the rotary dimmer covers from the various Gira design lines. The Komfort rotary dimmer can also be controlled from many operating points with the system auxiliary units.

The Gira universal LED dimmer Mini transforms a commercially-available momentary button into a universal dimmer. The compact design simplifies installation in the device box behind the button. The dimmer calibrates itself independently to the connected light source.

In distribution boards, the Gira universal LED dimmer DRA and power boosters are used. Using power boosters to supplement the dimmers makes it possible to dim larger power loads.

The Gira LED compensation module enables the operation of dimmable HV LED lamps in conjunction with Gira Universal or Tronic dimmers. It improves the dimming behaviour and prevents flickering and afterglow in dimmable HV LED lamps.



Gira System 3000 lighting control, operating top unit  
Design line: Gira Esprit, umber glass/cream white glossy



## Control options: Blinds

### Individual control

If there are only a few blinds to control, for example in small flats, individual control on-site is a good solution. Of course this can be done at the press of a button, via remote control, or using timers or sensors.

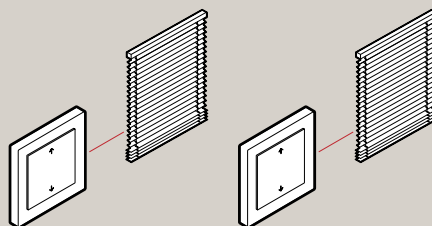

### Group control

One device in the system serves as the master device and transmits the control commands to all the downstream devices. Each blind can, of course, also be controlled locally. Group control makes good sense, for example in a detached family house or in smaller office spaces.

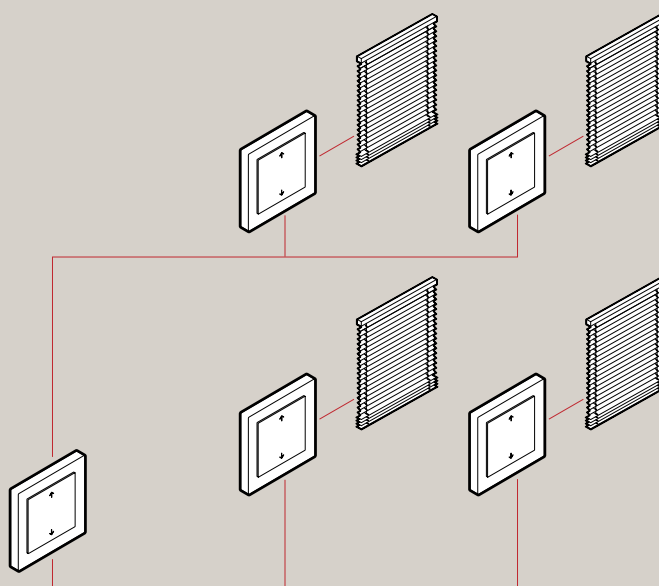

### Central control

In larger buildings, e.g. office buildings, all blinds can be centrally controlled, for example to protect them against an approaching storm. This task can also be performed by a wind sensor. To this end, the devices of each floor are grouped and an additional insert is installed as higher-level master.

The blinds can then also be controlled for each floor separately, or individually on site.

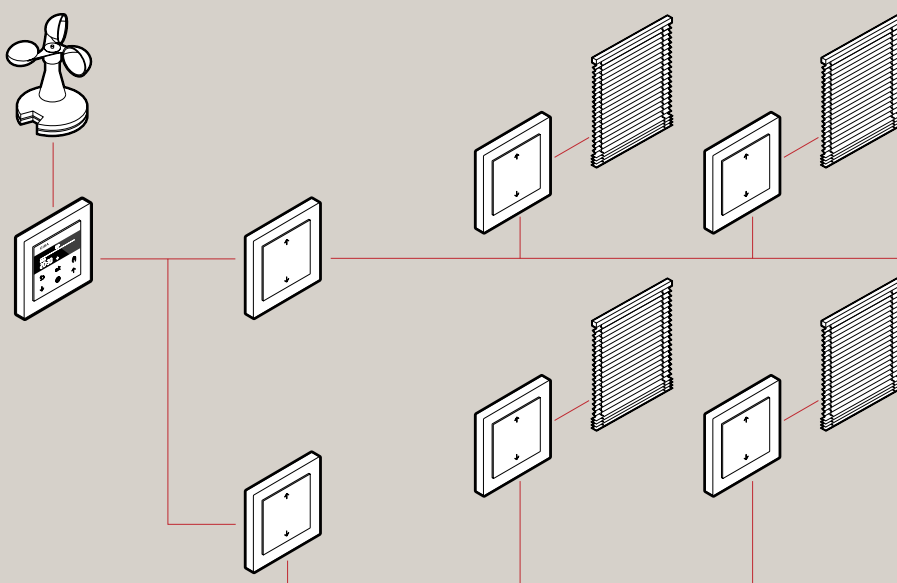

## Control options: Lighting

### Manual control

With the various operating top units, lamps can be switched and dimmed manually. In combination with auxiliary inserts, this is also possible from several operating points.

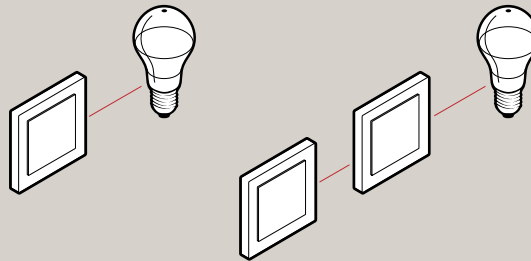

### Time-dependent control

The system top units with time control – Memory, Display and Bluetooth – enable switching and dimming with individual time profiles. With the auxiliary units, it is possible to expand to several operating points at any time.

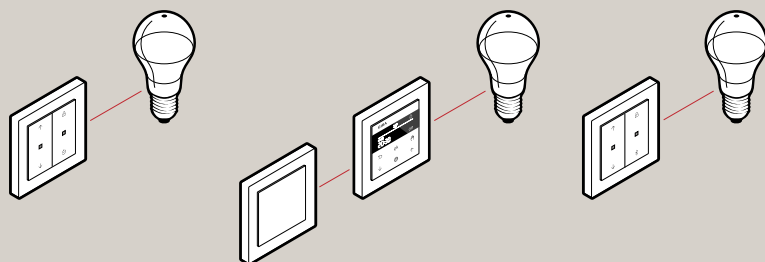

### Motion-dependent control

The motion detector top units switch and dim the light completely automatically, depending on the ambient light and the detected motion. The detection zone can be increased with additional motion detectors and auxiliary inserts. With basic operating top units, manual control is also possible.

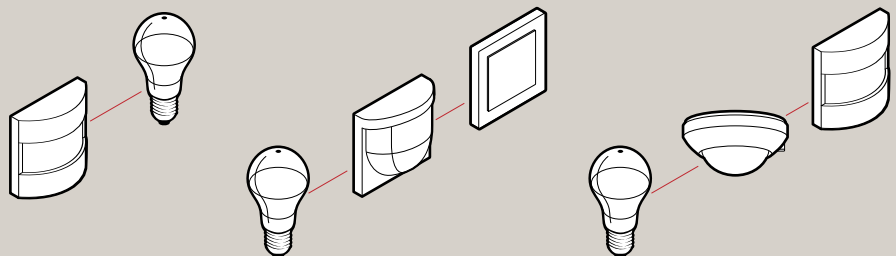

### Combinations and central control units

Combining the different system inserts and top units offers many control options, e.g. expanding the time control with motion detectors or controlling several independent controllers centrally.

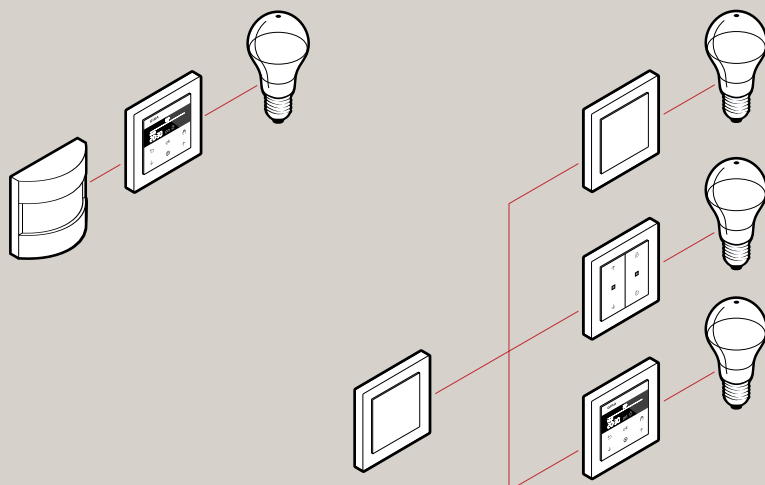

















## Function overview

The modular system consisting of power inserts and operating top units offers the greatest possible freedom in combining products and implementing functions. Manual actuation with a control button is possible alongside electronic time-dependent or motion-dependent lighting control. Central functions can also be implemented via the auxiliary inputs, e.g. by means of a wind sensor or a master button.

In blind and shutter control, auxiliary units can be used for the higher-level operation of groups and central control.







In lighting control, the auxiliary units usually serve as additional control points or are used to expand the detection ranges of motion detectors. A new feature here is the option of centrally operating up to 5 switching and dimming inserts with the 3-wire auxiliary insert. It is also possible to combine timers with motion detectors in the System 3000.

	Lighting control			
	 Relay switching insert Order no. 5403 00	 Electronic switching insert Order no. 5405 00	 universal LED dimming insert Standard Order no. 5400 00	 universal LED dimming insert Komfort Order no. 5401 00
 Operating top unit Order no. 5360 .. and operating top unit arrow symbols Order no. 5361 ..	Switching	Switching	Switching Dimming	Switching Dimming
 Operating top unit Memory Order no. 5363 ..	Switching Memory	Switching Memory	Switching Dimming Memory	Switching Dimming Memory
 Blind timer and timer Display Order no. 5366 ..	Switching Memory Timer	Switching Memory Timer	Switching/dimming Memory Timer	Switching/dimming Memory Timer
 Blind timer and timer Bluetooth Order no. 5367 ..	Switching Timer App operation	Switching Timer App operation	Switching/dimming Timer App operation	Switching/dimming Timer App operation
 Motion detector 1.10 m Standard Order no. 5373 .. <input checked="" type="checkbox"/>	Switching	Switching	Switching	Switching
 Motion detector 1.10 m Komfort Bluetooth Order no. 5374 .. <input checked="" type="checkbox"/>	Switching App operation	Switching App operation	Switching Dimming App operation	Switching Dimming App operation
 Motion detector 2.20 m Standard Order no. 5375 .. <input checked="" type="checkbox"/>	Switching	Switching	Switching	Switching
 Motion detector 2.20 m Komfort Bluetooth Order no. 5376 .. <input checked="" type="checkbox"/>	Switching App operation	Switching App operation	Switching Dimming App operation	Switching Dimming App operation
 Presence and motion detector 360° Bluetooth Order no. 5377 02	Switching App operation	Switching App operation	Switching Constant lighting control App operation	Switching Constant lighting control App operation

 For mounting height up to 1.10 m with purely horizontally aligned detection area, which means it doesn't have its own range limitation outdoors

 For mounting height up to 2.20 m with angled, vertically aligned detection area

① Depends on the main unit to be controlled

Lighting control				Blind control	
 DALI power control unit Tuneable White <u>Order no. 5406 00</u>	 Auxiliary insert, 2-wire <u>Order no. 5408 00</u>	 Auxiliary insert, 3-wire <u>Order no. 5409 00</u>	 Impulse insert <u>Order no. 5410 00</u> with staircase-light automatic control switch <u>Order no. 0821 00</u>	 Blind control insert with auxiliary input <u>Order no. 5414 00</u>	 Blind control insert without auxiliary input <u>Order no. 5415 00</u>
Switching Dimming Tuneable White	① Switching Dimming Tuneable White	① Switching Dimming Tuneable White	Switching on	Up/down Individual position	Up/down Individual position
Switching Dimming Memory	---	① Switching Dimming	---	Up/down Individual position Memory	Up/down Individual position Memory
Switching/dimming Memory Timer	---	① Switching Dimming	---	Up/down, position Memory Blind timer	Up/down, position Memory Blind timer
Switching/dimming Timer App operation	---	① Switching Dimming	---	Up/down, position Blind timer App operation	Up/down, position Blind timer App operation
Switching	---	Switching on	Switching on	---	---
Switching Dimming App operation	---	Switching on	Switching on	---	---
Switching	---	Switching on	Switching on	---	---
Switching Dimming App operation	---	Switching on	Switching on	---	---
Switching Constant lighting control App operation	---	Switching on	Switching on	---	---

## Product features and data: Top units

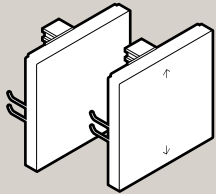

Gira System 3000 top unit and operating top unit arrow symbols

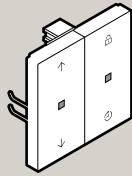

Gira System 3000 operating top unit Memory



Gira System 3000 blind timer and timer Display

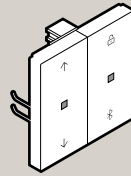

Gira System 3000 Blind timer and timer Bluetooth

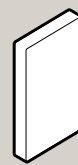

Gira System 3000 brightness and temperature sensor Bluetooth

Manual control of lighting and blinds

Saving of individual intermediate position

Ambient temperature: -5 °C to +45 °C

Manual control of lighting and blinds

Saving of individual intermediate position

Saving of switch-on and switch-off time, repetition in 24-hour cycle if memory operation is activated

Blocking function to deactivate the auxiliary unit and memory mode

Night mode: Status LED and function LED are not lit continuously

Ambient temperature: -5 °C to +45 °C

Manual control of lighting and blinds

Saving of individual intermediate position

Timer: Easy to operate and program

Rapid programming: Saving of current time as switching time

Standard time program

Astro function

Automatic summer/winter time

Blocking function: Deactivation of auxiliary unit and automatic function

Ambient temperature: -5 °C to +45 °C

Accuracy per month: ± 10 s

Power reserve: approx. 4 h

Manual control of lighting and blinds

Saving of individual intermediate position

Control and programming via app, using smartphones and tablets

Programs can easily be copied to other blind timers and timers

Up to 40 switching times in individual day blocks possible

Up to 50 products can be managed in the app

Random function

Astro function

Automatic summer/winter time

Blocking function to deactivate the auxiliary and automatic function

Temperature-dependent sun and twilight function with brightness and temperature sensor Bluetooth

Ambient temperature: -5 °C to +45 °C

Time and location synchronisation via smartphone

Power reserve: approx. 4 h

Recording of brightness and temperature values

Control of lighting and blinds

Transmission of the values via Bluetooth

Brightness values from 5 lux to 80,000 lux

Ambient temperature: -5 °C to +55 °C

Adhesive mounting indoors

Battery-operated (CR 2450)

## Product features and data: Motion detectors

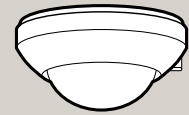
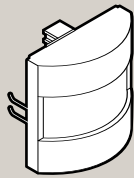
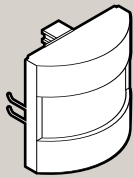

Gira System 3000  
motion detector top unit  
1.10 m  
Standard

Gira System 3000  
motion detector top unit  
1.10 m  
Komfort Bluetooth

Gira System 3000  
motion detector top unit  
2.20 m  
Standard

Gira System 3000  
motion detector top unit  
2.20 m  
Komfort Bluetooth

Gira System 3000  
presence and motion  
detector  
360° top unit Bluetooth

Motion- and brightness-  
dependent lighting  
control

Motion- and brightness-  
dependent lighting  
control

Motion- and brightness-  
dependent lighting  
control

Motion- and brightness-  
dependent lighting  
control

Motion- and brightness-  
dependent lighting  
control, as motion or  
presence detector

The light stays on  
as long as motion is  
detected while the  
ambient light is too low.  
Fixed delay time:  
2 min.

Additional functions  
compared to Standard:

The light stays on  
as long as motion is  
detected while the  
ambient light is too low.  
Fixed delay time:  
2 min.

Additional functions  
compared to Standard:

Additional functions  
compared to Standard:

Brightness threshold  
can be set via  
potentiometer

Control and  
programming via app,  
using smartphones and  
tablets

Brightness threshold  
can be set via  
potentiometer

Control and  
programming via app,  
using smartphones and  
tablets

Switchover between  
detector mode and  
presence mode

Constant lighting  
control

Sensor sensitivity can  
be set via potentiometer

Programs can easily be  
copied to other motion  
detectors

Sensor sensitivity can  
be set via potentiometer

Programs can easily be  
copied to other motion  
detectors

Control and  
programming via app,  
using smartphones and  
tablets

Operation on all  
System 3000 switching  
and dimming inserts,  
as well as the 3-wire  
auxiliary unit

Occupancy simulation  
(repetition of switching  
operations of previous  
day)

Operation on all System  
3000 switching and  
dimming inserts, as well  
as the 3-wire auxiliary  
unit

Occupancy simulation  
(repetition of switching  
operations of previous  
day)

Programs can easily be  
copied to other motion  
detectors

For conversion of button  
circuits in staircases in  
combination with the  
System 3000 impulse  
insert and the DRA  
staircase light timer

Alarm function  
(light flashes in event of  
detection)

For conversion of  
button circuits in  
staircases in  
combination with the  
System 3000 impulse  
insert and the DRA  
staircase light timer

Alarm function  
(light flashes in event of  
detection)

Night light function  
(at night, light is dimmed  
when switched on)

Occupancy simulation  
(repetition of switching  
operations of previous  
day)

Alarm function  
(light flashes in event of  
detection)

Ambient temperature:  
-20 °C to +45 °C

Hotel function  
(light dims, but does not  
switch off)

Ambient temperature:  
-20 °C to +45 °C

Hotel function  
(light dims, but does not  
switch off)

Night light function  
(at night, light is dimmed  
when switched on)

Dynamic self-learning  
delay time  
(convenience and  
energy savings)

Dynamic self-learning  
delay time  
(convenience and  
energy savings)

Hotel function  
(light dims, but does not  
switch off)

Dynamic self-learning  
delay time  
(convenience and  
energy savings)

## Product features and data: Inserts

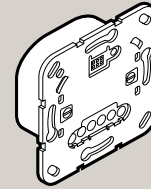
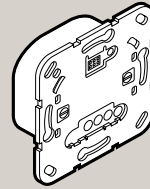
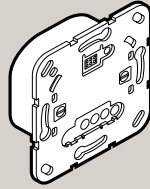
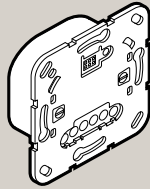
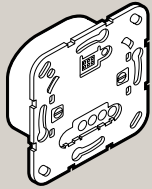

Gira System 3000  
relay switching insert

Gira System 3000  
electronic switching  
insert

Gira System 3000  
universal LED dimming  
insert  
Standard

Gira System 3000  
universal LED dimming  
insert  
Komfort

Gira System 3000  
DALI power control unit  
Flush-mounted insert

Installation depth: 24 mm	Installation depth: 24 mm	Installation depth: 24 mm	Installation depth: 24 mm	Installation depth: 30 mm
Rated voltage: AC 230 V ~	Rated voltage: AC 230 V ~	Rated voltage: AC 230 V ~	Rated voltage: AC 230 V ~	Rated voltage: AC 230 V ~
Mains frequency: 50/60 Hz	Mains frequency: 50/60 Hz	Mains frequency: 50/60 Hz	Mains frequency: 50/60 Hz	Mains frequency: 50/60 Hz
Test button for function test and start-up	Test button for function test and operating mode selection:	Test button for function test and operating mode selection:	Additional functions compared to Standard:	For controlling DALI lights and DALI ballast devices with or without TuneableWhite function
Staircase light function: 1/5/30/60 Min.	- Universal leading edge - Trailing edge	- Universal leading edge - Trailing edge - Setting for basic brightness	Power range: - Light bulbs up to 420 W - HV LED lamps: Leading edge typ. 100 W Trailing edge typ. 200 W	For max. 18 DALI devices
Switching capacity: 16 A/AC 1 typ. 500 W HV LED lamps	Can be used with or without neutral conductor: - Without neutral conductor only for dimnable light sources - With neutral conductor also for switchable light sources	Can be used with or without neutral conductor; with neutral conductor, the minimum load is lower and the dimming behaviour is improved	Auxiliary input for connecting 2-wire and 3 wire System 3000 auxiliary inserts or rocker buttons	Maximum 4 "active" DALI inserts can be switched in parallel, to increase number of participating devices
Ambient temperature: -25 °C to +45 °C	Power range: - Light bulbs up to 400 W - HV LED lamps: Leading edge typ. 100 W Trailing edge typ. 200 W	Power range: - Light bulbs up to 210 W - HV LED lamps: Leading edge typ. 60 W Trailing edge typ. 120 W		Auxiliary input for connecting 2-wire and 3 wire System 3000 auxiliary inserts or rocker buttons
Standby power: Top unit dependent 0.2 to 0.5 W	Ambient temperature: -5 °C to +45 °C	Ambient temperature: -5 °C to +45 °C		Ambient temperature: -5 °C to +45 °C
Connections: Solid and stranded without ferrule 0.5 to 4.0 mm <sup>2</sup> or 2 × 2.5 mm <sup>2</sup> , fine-stranded with ferrule 0.5 to 2.5 mm <sup>2</sup>	Standby power: Top unit dependent 0.2 to 0.5 W	Standby power: Top unit dependent 0.2 to 0.5 W		Standby power: Top unit dependent 0.2 to 0.5 W
	Connections: Solid and stranded without ferrule 0.5 to 4.0 mm <sup>2</sup> or 2 × 2.5 mm <sup>2</sup> , fine-stranded with ferrule 0.5 to 2.5 mm <sup>2</sup>	Connections: Solid and stranded without ferrule 0.5 to 4.0 mm <sup>2</sup> or 2 × 2.5 mm <sup>2</sup> , fine-stranded with ferrule 0.5 to 2.5 mm <sup>2</sup>		Connections: Solid and stranded without ferrule 0.5 to 4.0 mm <sup>2</sup> or 2 × 2.5 mm <sup>2</sup> , fine-stranded with ferrule 0.5 to 2.5 mm <sup>2</sup>

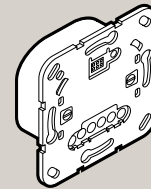
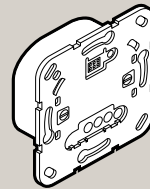
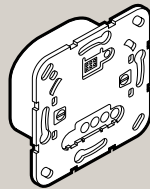
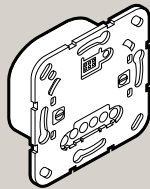
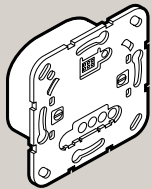

Gira System 3000  
auxiliary insert, 2-wire

Gira System 3000  
auxiliary insert, 3-wire

Gira System 3000  
impulse insert

Gira System 3000  
blind control insert  
without auxiliary input

Gira System 3000  
blind control insert with  
auxiliary input

Installation depth: 24 mm	Installation depth: 24 mm	Installation depth: 24 mm	Installation depth: 24 mm	Additional functions compared to blind control insert without auxiliary input
Rated voltage: AC 230 V ~	Rated voltage: AC 230 V ~	Rated voltage: AC 230 V ~	Rated voltage: AC 230 V ~	Integration into groups or central control units
Mains frequency: 50/60 Hz	Mains frequency: 50/60 Hz	Mains frequency: 50/60 Hz	Mains frequency: 50/60 Hz	Wind alarm lock via auxiliary input
Connecting any number of 2-wire auxiliary units to a main unit is possible	Can be combined with all System 3000 top units	Can be combined with System 3000 motion detectors, as well as the operating top unit and operating top unit arrow symbols	Test button for function test and start-up	
Can be combined with System 3000 operating top unit and operating top unit arrow symbols	Up to 5 main units can be jointly controlled with a 3-wire auxiliary unit	For installation or retrofitting of motion detectors in the staircase	Contact type: $\mu$ contact	
Ambient temperature: -25 °C to +45 °C	Connecting 5 auxiliary units, 3-wire, to a main unit	Operation exclusively with staircase light timer DRA 0821 00	Standby power: Top-unit dependent 0.2 to 0.5 W	
Connections: Solid and stranded without ferrule 0.5 to 4.0 mm <sup>2</sup> or 2 × 2.5 mm <sup>2</sup> , fine-stranded with ferrule 0.5 to 2.5 mm <sup>2</sup>	Connecting 2-wire and/ or 3-wire auxiliary units to a main unit	Can be expanded at staircase light timer DRA with 2-wire auxiliary insert in combination with basic operating top unit and rocker buttons.	Connected load Motors: 700 W	
	Motion detector brightness evaluation on	Ambient temperature: -5 °C to +45 °C	Ambient temperature: -5 °C to +45 °C	
	Ambient temperature: -25 °C to +45 °C		Connections: Solid and stranded without ferrule 0.5 to 4.0 mm <sup>2</sup> or 2 × 2.5 mm <sup>2</sup> , fine-stranded with ferrule 0.5 to 2.5 mm <sup>2</sup>	
	Standby power: Top unit dependent 0.2 to 0.5 W			
	Connections: Solid and stranded without ferrule 0.5 to 4.0 mm <sup>2</sup> or 2 × 2.5 mm <sup>2</sup> , fine-stranded with ferrule 0.5 to 2.5 mm <sup>2</sup>	Ambient temperature: -5 °C to +45 °C		
		Standby power: Top unit dependent 0.2 to 0.5 W		
		Connections: Solid and stranded without ferrule 0.5 to 4.0 mm <sup>2</sup> or 2 × 2.5 mm <sup>2</sup> , fine-stranded with ferrule 0.5 to 2.5 mm <sup>2</sup>		

## Product features and data: Kompakt dimmers

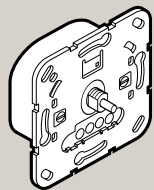

Gira System 3000  
universal LED rotary dimming  
insert  
Standard

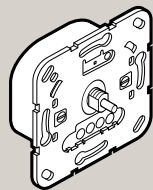

Gira System 3000  
universal LED rotary dimming  
insert  
Komfort

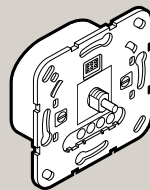

Gira System 3000  
rotary auxiliary insert, 3-wire,  
for LED dimmer

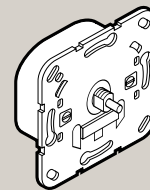

Gira System 3000  
LED dimmer  
with rotary on/off switch

Installation depth: 24 mm

Rated voltage: AC 230 V ~

Mains frequency: 50/60 Hz

Dimming behaviour can be set  
automatically

Setting for basic brightness

Can be used with or without  
neutral conductor; with neutral  
conductor, the minimum load  
is lower and the dimming  
behaviour is improved

Power range:  
- Light bulbs up to 210 W  
- HV LED lamps:  
  Leading edge typ. 60 W  
  Trailing edge typ. 120 W

Ambient temperature:  
-5 °C to +45 °C

Standby power:  
approx. 0.2 W

Connections:  
Solid and stranded without  
ferrule  
0.5 to 4.0 mm<sup>2</sup> or  
2 × 2.5 mm<sup>2</sup>,  
fine-stranded with ferrule  
0.5 to 2.5 mm<sup>2</sup>

Installation depth: 24 mm

Rated voltage: AC 230 V ~

Mains frequency: 50/60 Hz

Additional functions compared  
to Standard:

Test button for  
operating mode selection:  
- Universal  
- Leading edge  
- Trailing edge  
- Setting for basic brightness

Power range:  
- Light bulbs up to 420 W  
- HV LED lamps:  
  Leading edge typ. 100 W  
  Trailing edge typ. 200 W

Installation depth: 24 mm

Rated voltage: AC 230 V ~

Mains frequency: 50/60 Hz

Requires neutral conductor  
connection

Suitable for use with System  
3000 rotary, touch, built-in and  
DRA dimmers

Ambient temperature:  
-5 °C to +45 °C

Standby power:  
approx. 0.2 W

Connections:  
Solid and stranded without  
ferrule  
0.5 to 4.0 mm<sup>2</sup> or  
2 × 2.5 mm<sup>2</sup>,  
fine-stranded with ferrule  
0.5 to 2.5 mm<sup>2</sup>

Installation depth: 32 mm

Rated voltage: AC 230 V ~

Mains frequency: 50 Hz

Operation with rotary on/off  
switch

Does not require neutral  
conductor connection

Power range:  
- Light bulbs up to 200 W  
- HV LED lamps:  
  Leading edge typ. 40 W

Ambient temperature:  
+5 °C to +45 °C

Connections:  
Solid and stranded without  
ferrule  
0.5 to 4.0 mm<sup>2</sup> or  
2 × 2.5 mm<sup>2</sup>,  
fine-stranded with ferrule  
0.5 to 2.5 mm<sup>2</sup>



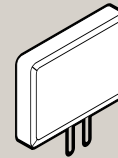
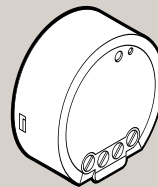
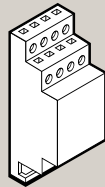
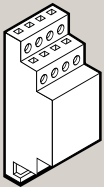

Gira System 3000  
universal LED dimmer DRA

Gira System 3000  
universal LED power booster  
DRA

Gira System 3000  
universal LED dimmer Mini  
DRA

Gira System 3000  
compensation module LED

2 modular widths

Rated voltage: AC 230 V ~

Mains frequency: 50/60 Hz

With manual actuation

Auxiliary input for connecting 2-wire and 3 wire System 3000 auxiliary inserts or rocker buttons

Operating mode selection:  
- Universal  
- Leading edge  
- Trailing edge  
- Setting for basic brightness

Requires neutral conductor connection

Power range:  
- Light bulbs up to 420 W  
- HV LED lamps:  
  Leading edge typ. 100 W  
  Trailing edge typ. 200 W

Ambient temperature:  
+5 °C to +45 °C

Standby power:  
< 0.5 W

Connections:  
Solid and stranded without ferrule  
0.5 to 4.0 mm<sup>2</sup> or  
2 × 2.5 mm<sup>2</sup>,  
fine-stranded with ferrule  
0.5 to 2.5 mm<sup>2</sup>

2 modular widths

Rated voltage: AC 230 V ~

Mains frequency: 50/60 Hz

Mode follows the combined dimmer

Requires neutral conductor connection

Power range:  
- Light bulbs up to 420 W  
- HV LED lamps:  
  Leading edge typ. 100 W  
  Trailing edge typ. 200 W

Max. 2 power boosters can be connected per dimmer

Ambient temperature:  
+5 °C to +45 °C

Standby power:  
< 0.5 W

Connections:  
Solid and stranded without ferrule  
0.5 to 4.0 mm<sup>2</sup> or  
2 × 2.5 mm<sup>2</sup>,  
fine-stranded with ferrule  
0.5 to 2.5 mm<sup>2</sup>

Dimensions:  
48 × 18 (19.5) mm

Rated voltage: AC 230 V ~

Mains frequency: 50/60 Hz

Test button for function test and operating mode selection:  
- Universal  
- Leading edge  
- Trailing edge  
- Setting for basic brightness

Auxiliary input for connecting 2-wire and 3 wire System 3000 auxiliary inserts or rocker buttons

Can be used with or without neutral conductor; with neutral conductor, the minimum load is lower and the dimming behaviour is improved

Power range:  
- Light bulbs up to 210 W  
- HV LED lamps:  
  Leading edge typ. 50 W  
  Trailing edge typ. 100 W

Ambient temperature:  
-5 °C to +45 °C

Standby power:  
< 0.5 W

Connections:  
Solid and stranded without ferrule  
0.5 to 4.0 mm<sup>2</sup> or  
2 × 2.5 mm<sup>2</sup>,  
fine-stranded with ferrule  
0.5 to 2.5 mm<sup>2</sup>

Dimensions:  
43 × 28.5 × 11.5 mm

Rated voltage: AC 230 V ~

Mains frequency: 50/60 Hz

Enables operation of dimmable HV LED lamps in conjunction with Gira Universal or Tronic dimmers

Improves the dimming behaviour and prevents flickering and afterglow in dimmable HV LED lamps, also when using switches with orientation light < 3 mA

Compensates up to 3 light sources

Installation behind the dimmer or in the light

Ambient temperature:  
+5 °C to +45 °C

Standby power:  
< 2 W

Connection via preconfigured lines, approx. 15 cm long



Gira System 3000 blind control, blind timer and timer Display  
Design line: Gira E2 flat installation, pure white glossy

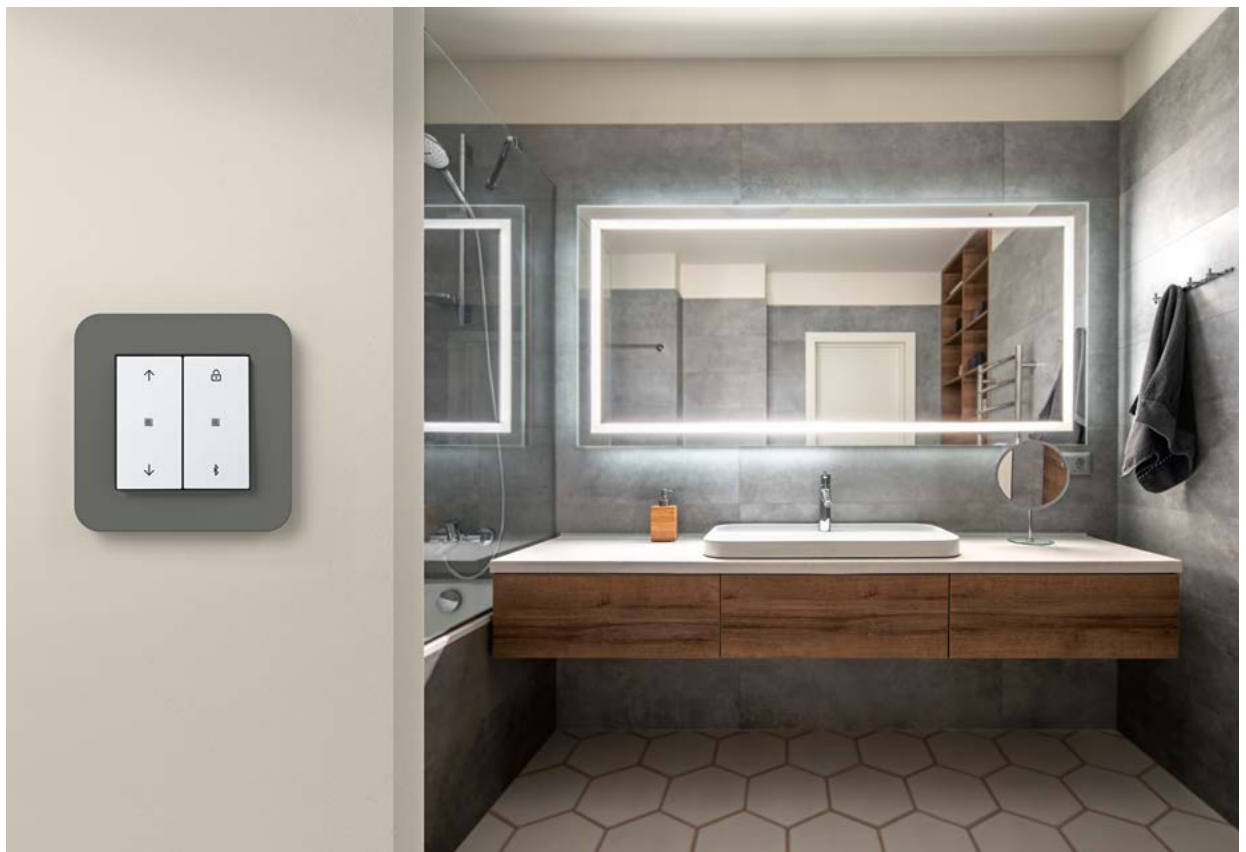

Gira System 3000 lighting control, blind timer and timer Bluetooth  
Design line: Gira E3 dark grey soft touch, pure white glossy

# Gira System 3000

## Range overview

### System 3000 top units

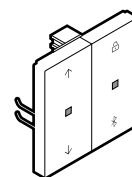
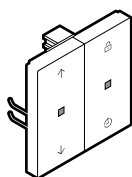
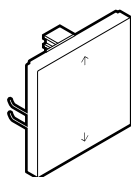
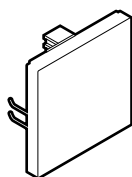

Gira System 3000  
operating top unit

Gira System 3000  
operating top unit  
arrow symbols

Gira System 3000  
operating top unit  
Memory

Gira System 3000  
blind timer and timer  
Display

Gira System 3000  
blind timer and timer  
Bluetooth

System 55

System 55

System 55

System 55

System 55

Cream white glossy  
Order no. 5360 01

Cream white glossy  
Order no. 5361 01

Cream white glossy  
Order no. 5363 01

Cream white glossy  
Order no. 5366 01

Cream white glossy  
Order no. 5367 01

Pure white glossy  
Order no. 5360 03

Pure white glossy  
Order no. 5361 03

Pure white glossy  
Order no. 5363 03

Pure white glossy  
Order no. 5366 03

Pure white glossy  
Order no. 5367 03

Pure white matt  
Order no. 5360 27

Pure white matt  
Order no. 5361 27

Pure white matt  
Order no. 5363 27

Pure white matt  
Order no. 5366 27

Pure white matt  
Order no. 5367 27

Anthracite  
Order no. 5360 28

Anthracite  
Order no. 5361 28

Anthracite  
Order no. 5363 28

Anthracite  
Order no. 5366 28

Anthracite  
Order no. 5367 28

Colour aluminium  
Order no. 5360 26

Colour aluminium  
Order no. 5361 26

Colour aluminium  
Order no. 5363 26

Colour aluminium  
Order no. 5366 26

Colour aluminium  
Order no. 5367 26

Stainless steel  
Order no. 5360 600

Stainless steel  
Order no. 5361 600

Stainless steel  
Order no. 5363 600

Stainless steel  
(lacquered)  
Order no. 5366 600

Stainless steel  
Order no. 5367 600

Gira E22 aluminium

Gira E22 aluminium

Gira E22 aluminium

Gira E22 aluminium

Gira E22 aluminium

Aluminium  
Order no. 5360 203

Aluminium  
Order no. 5361 203

Aluminium  
Order no. 5363 203

Aluminium (lacquered)  
Order no. 5366 203

Aluminium  
Order no. 5367 203

Gira F100

Gira F100

Gira F100

Gira F100

Gira F100

Pure white  
Order no. 5360 112

Pure white glossy  
Order no. 5361 112

Pure white glossy  
Order no. 5363 112

Pure white glossy  
Order no. 5366 112

Pure white glossy  
Order no. 5367 112

Motion detectors and sensors of System 3000

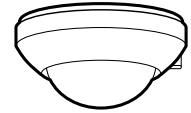
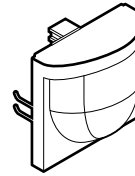
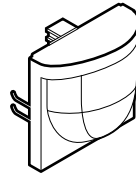
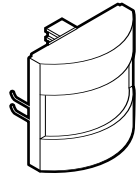
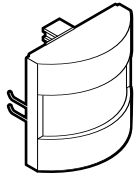

Gira System 3000  
motion detector top  
unit 1.10 m  
Standard

Gira System 3000  
motion detector top  
unit 1.10 m  
Komfort Bluetooth

Gira System 3000  
motion detector top  
unit 2.20 m  
Standard

Gira System 3000  
motion detector top  
unit 2.20 m  
Komfort Bluetooth

Gira System 3000  
presence and motion  
detector 360° top unit  
Bluetooth

System 55

System 55

System 55

System 55

Pure white

Order no. 5377 02

Cream white glossy  
Order no. 5373 01

Cream white glossy  
Order no. 5374 01

Cream white glossy  
Order no. 5375 01

Cream white glossy  
Order no. 5376 01

Pure white glossy  
Order no. 5373 03

Pure white glossy  
Order no. 5374 03

Pure white glossy  
Order no. 5375 03

Pure white glossy  
Order no. 5376 03

Pure white matt  
Order no. 53763 27

Pure white matt  
Order no. 5374 27

Pure white matt  
Order no. 5375 27

Pure white matt  
Order no. 5376 27

Anthracite  
Order no. 53763 28

Anthracite  
Order no. 5374 28

Anthracite  
Order no. 5375 28

Anthracite  
Order no. 5376 28

Colour aluminium  
Order no. 5373 26

Colour aluminium  
Order no. 5374 26

Colour aluminium  
Order no. 5375 26

Colour aluminium  
Order no. 5376 26

Stainless steel  
(lacquered)  
Order no. 5373 600

Stainless steel  
(lacquered)  
Order no. 5374 600

Stainless steel  
(lacquered)  
Order no. 5375 600

Stainless steel  
(lacquered)  
Order no. 5376 600

System 3000 sensor

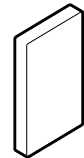

Gira E22 aluminium

Gira E22 aluminium

Gira E22 aluminium

Gira E22 aluminium

Aluminium (lacquered)  
Order no. 5373 203

Aluminium (lacquered)  
Order no. 5374 203

Aluminium (lacquered)  
Order no. 5375 203

Aluminium (lacquered)  
Order no. 5376 203

Gira TX\_44

Gira TX\_44

Gira TX\_44

Gira TX\_44

Gira System 3000  
brightness and temper-  
ature sensor  
Bluetooth

Colour aluminium  
Order no. 5373 65

Colour aluminium  
Order no. 5374 65

Colour aluminium  
Order no. 5375 65

Colour aluminium  
Order no. 5376 65

Pure white  
Order no. 5373 66

Pure white  
Order no. 5374 66

Pure white  
Order no. 5375 66

Pure white  
Order no. 5376 66

Pure white glossy  
Order no. 5466 02

Anthracite  
Order no. 5373 67

Anthracite  
Order no. 5374 67

Anthracite  
Order no. 5375 67

Anthracite  
Order no. 5376 67

Gira F100

Gira F100

Gira F100

Gira F100

Pure white glossy  
Order no. 5373 112

Pure white glossy  
Order no. 5374 112

Pure white glossy  
Order no. 5375 112

Pure white glossy  
Order no. 5376 112

Blind inserts

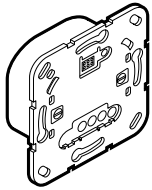

Gira System 3000  
blind control insert  
without auxiliary input

Order no. 5415 00

Light inserts

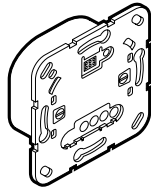

Gira System 3000  
universal LED dim-  
ming insert  
Standard

Order no. 5400 00

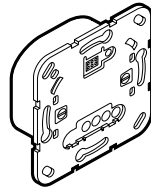

Gira System 3000  
universal LED dim-  
ming insert  
Komfort

Order no. 5401 00

Compact dimming

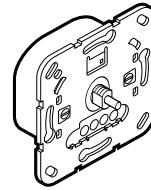

Gira System 3000  
universal LED rotary  
dimming insert  
Standard

Order no. 2450 00

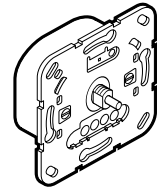

Gira System 3000  
universal LED rotary  
dimming insert  
Komfort

Order no. 2455 00

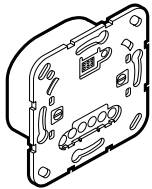

Gira System 3000  
blind control insert  
with auxiliary input

Order no. 5414 00

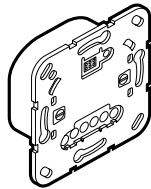

Gira System 3000  
flush-mounted  
DALI power contro  
l unit insert

Order no. 5406 00

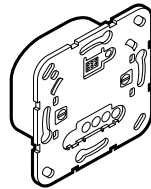

Gira System 3000  
relay switching insert

Order no. 5403 00

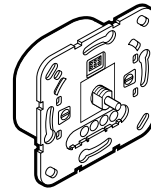

Gira System 3000  
rotary auxiliary insert,  
3-wire, for LED  
dimmer

Order no. 2389 00

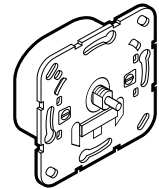

Gira System 3000  
LED dimmer  
Rotary on/off switch  
insert

Order no. 0300 00

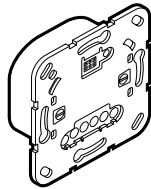

Gira System 3000  
electronic switching  
insert

Order no. 5405 00

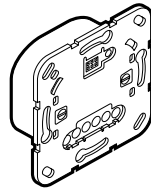

Gira System 3000  
impulse insert

Order no. 5410 00

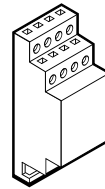

Gira System 3000  
universal LED dimmer  
DRA

Order no. 2365 00

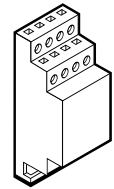

Gira System 3000  
universal LED power  
booster DRA

Order no. 2383 00

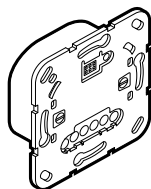

Gira System 3000  
auxiliary insert, 2-wire

Order no. 5408 00

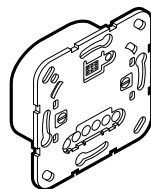

Gira System 3000  
auxiliary insert, 3-wire

Order no. 5409 00

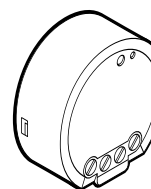

Gira System 3000  
universal LED dimmer  
Mini

Order no. 2440 00

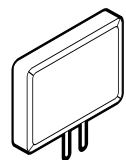

Gira System 3000  
compensation module  
LED

Order no. 2375 00

## More about Gira

Intelligent building technology from Gira offers more convenience, greater security, extensive functions, and a high degree of flexibility and mobility. Gira develops and manufactures systems and products that set standards both in technology and design.

More information on Gira and Gira products can be found at:

[www.gira.com/uk](http://www.gira.com/uk)

The entire Gira product range and individual prices can be found in the Gira online catalogue at:

[katalog.gira.de/en\\_UK/](http://katalog.gira.de/en_UK/)

The Gira Design Configurator can be accessed online and includes prices for selected complete devices and functions:

[www.designconfigurator.gira.com](http://www.designconfigurator.gira.com)

Follow the Gira community on Facebook, Twitter, YouTube, Google+, and Instagram. For more information, please visit:

[www.gira.com/socialmedia](http://www.gira.com/socialmedia)



Published by:  
Gira, Giersiepen GmbH & Co. KG

Concept, design:  
schmitz Visuelle Kommunikation  
[www.hgschmitz.de](http://www.hgschmitz.de)

Realisation, editing,  
layout update:  
piratas Werbeagentur  
[www.piratas.de](http://www.piratas.de)

Picture credits:  
piratas Werbeagentur,  
vimago GmbH  
(title page top, p. 04, 09 top,  
15-18, 21, 33)  
schmitz Visuelle Kommunikation  
(title page bottom, p. 05, 06, 09  
bottom, 10, 11-13, 19, 32)  
H. G. Esch,  
front cover  
Architecture of production  
facility: Ingenhoven and Partner  
Architects  
Gerhardt Kellermann  
(p. 09 bottom)

Lithography:  
vimago GmbH, Krefeld

Print:  
paffrath print & medien gmbh,  
Remscheid

Subject to technical  
modifications

Any colour variations between  
the images in this product  
information and specific  
products are due to printing  
processes and cannot be  
avoided.

Gira and sustainability:  
Gira has set itself the task of  
acting responsibly and  
supporting the sustainable  
development of society. For the  
production of this brochure, we  
have therefore endeavoured  
to reduce the consumption of  
resources and emission of  
harmful gases and to prevent  
environmental pollution as  
much as possible.

We strive to reach these goals  
by using eco-friendly materials.  
The paper used has been FSC  
certified and is made of at least  
60% recycled paper.

Please visit the Gira  
sustainability portal for more  
information on our current  
activities and projects:

[www.sustainability.gira.com](http://www.sustainability.gira.com)





# GIRA

Gira  
Giersiepen GmbH & Co. KG  
Electrical installation  
systems

Industriegebiet Mermbach  
Dahlienstraße  
42477 Radevormwald

Postfach 12 20  
42461 Radevormwald

Germany

Tel +49 2195 602-0  
Fax +49 2195 602-191

[www.gira.com/uk](http://www.gira.com/uk)

Gira UK Ltd

Lakeside House  
1 Furzeground Way,  
Stockley Park  
Uxbridge, Middlesex,  
UB 11 1BD

Tel +44 203 9368090

[info@gira.com](mailto:info@gira.com)