

Gira G1 The multi-talent for building technology



**GIRA**

## Our company Gira

Over 100 years of tradition and innovation	03
--------------------------------------------	----

## Gira G1

The multi-talent for building technology	13
High quality and precision	14
Flat, compact, elegant	15
Thoughtful design down to the smallest detail	16
Simply brilliant	17
Clear, intuitive, user-friendly	19
As easy as a switch	20
Door communication in elegant style	21
Building technology in a 9 × 16 cm format	22
LAN or WLAN	24

## System

Gira G1 as a KNX room control device	25
Gira G1 as a home station	25
Networking and power supply with WLAN connection	26
Networking and power supply with LAN connection	26
Installation and start-up	27
Convenient start-up	27
Topology	28
Technical data	30

## Over 100 years of tradition and innovation



Dirk Giersiepen,  
Managing Partner in the fourth generation

### From a switch manufacturer to a systems supplier

The roots of the German family-run company Gira extend back to 1903. In that year, Richard Giersiepen designed a further development of the then-common toggle switch and applied for a patent. Two years later he founded a company together with his brother Gustav to introduce his invention and other parts for home installation to the market. With this step in 1905, the Giersiepen brothers laid the foundation for great success story. Since that time, Gira has continuously developed – from a switch manufacturer to a provider of intelligent building technology systems. Gira has been a family-run business for four generations.

### Quality Made in Germany

From the beginning, Gira has relied on quality – not only regarding materials and processing. Optimisation and advancement have always played a central role in the entire product range, as in the initial patent application. This is indicated by numerous innovations with which Gira has decisively shaped the market for electrical installations for more than a century: from a modular system for switches, buttons, and covers via the integration of intelligent features, such as door communication, in the switch ranges, to the Gira HomeServer and the Gira Interface for intuitive control of building technology. On several occasions, Gira has been honoured with the renowned Plus X Award for the most innovative brand in the field of home technology.

### Award-winning design

In addition to the most demanding requirements on quality and function, the topic of design has a long tradition at Gira. Gira products regularly receive awards in international design competitions such as the Red Dot design award and the iF product design award. Gira products excel through more than just their design, materials and workmanship: With a continuous integration of new technologies, functions and systems up to software development, Gira is setting new standards for holistic product design. The Gira G1 is the latest example.

### DIN EN ISO 9001

A high standard of quality in all the company's areas of activity is also confirmed by the DMSZ (Deutsche Managementsystem Zertifizierungsgesellschaft mbH) with the certificate pursuant to DIN EN ISO 9001:2008.



Gira production facility in Radevormwald

### **Member of the KNX Association and CEDIA**

As a member of the KNX Association and CEDIA, Gira ensures that its products and solutions meet international and manufacturer-independent standards.

### **Experiencing Gira live**

In the Gira Revox Studios, the interaction of home entertainment and intelligent building technology can be experienced live. Experts such as system integrators and audio specialists collaborate to present the latest innovations in building technology and multi-media with integrated functionalities.

In the other showrooms, there is an application-oriented presentation of Gira products in combination with technology for other fields including sanitary, heating, air conditioning or ventilation applications. The products are also presented integrated in diverse living spaces, for example in up-scale furniture stores.

To find a Gira showroom near you go to:  
[www.gira.com/showrooms](http://www.gira.com/showrooms)



**Simply convenient:** adjust the desired room temperature and lighting, or make presets for the next morning



Always in the right mood: Call up a pre-programmed scene at the touch of a finger, e.g. for a smooth start into the day with a

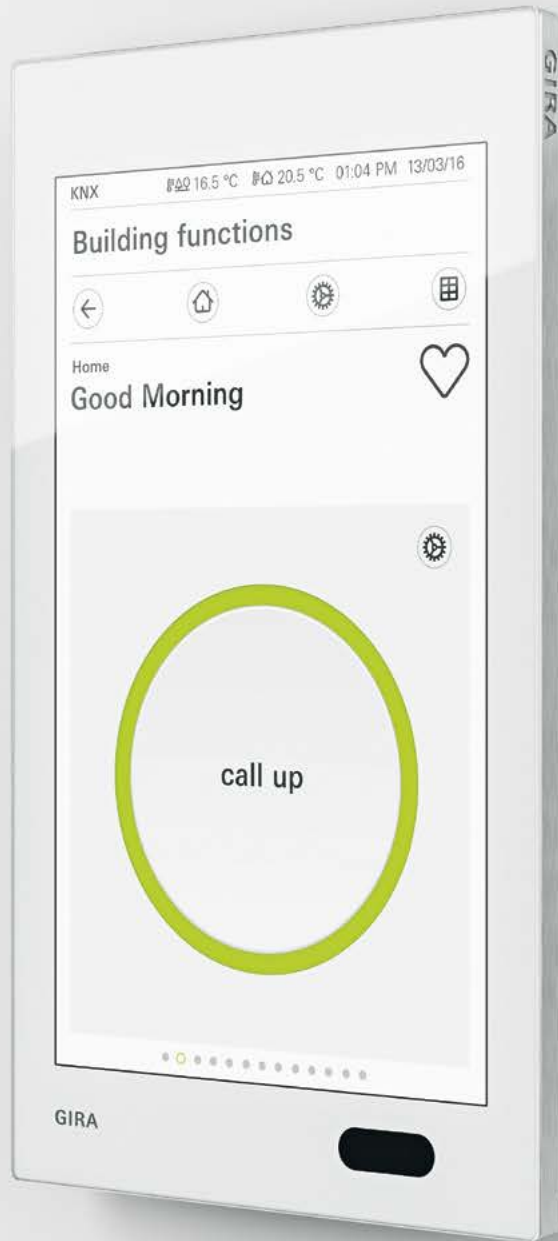

comfortable temperature, subtle lighting, open blinds, and your favourite music playing on the stereo





See who is at the door: use the Gira G1 as an intelligent home station







Switch lights with ease: Put your hand on the display to directly access a preset main function, for example to use the Gira G1

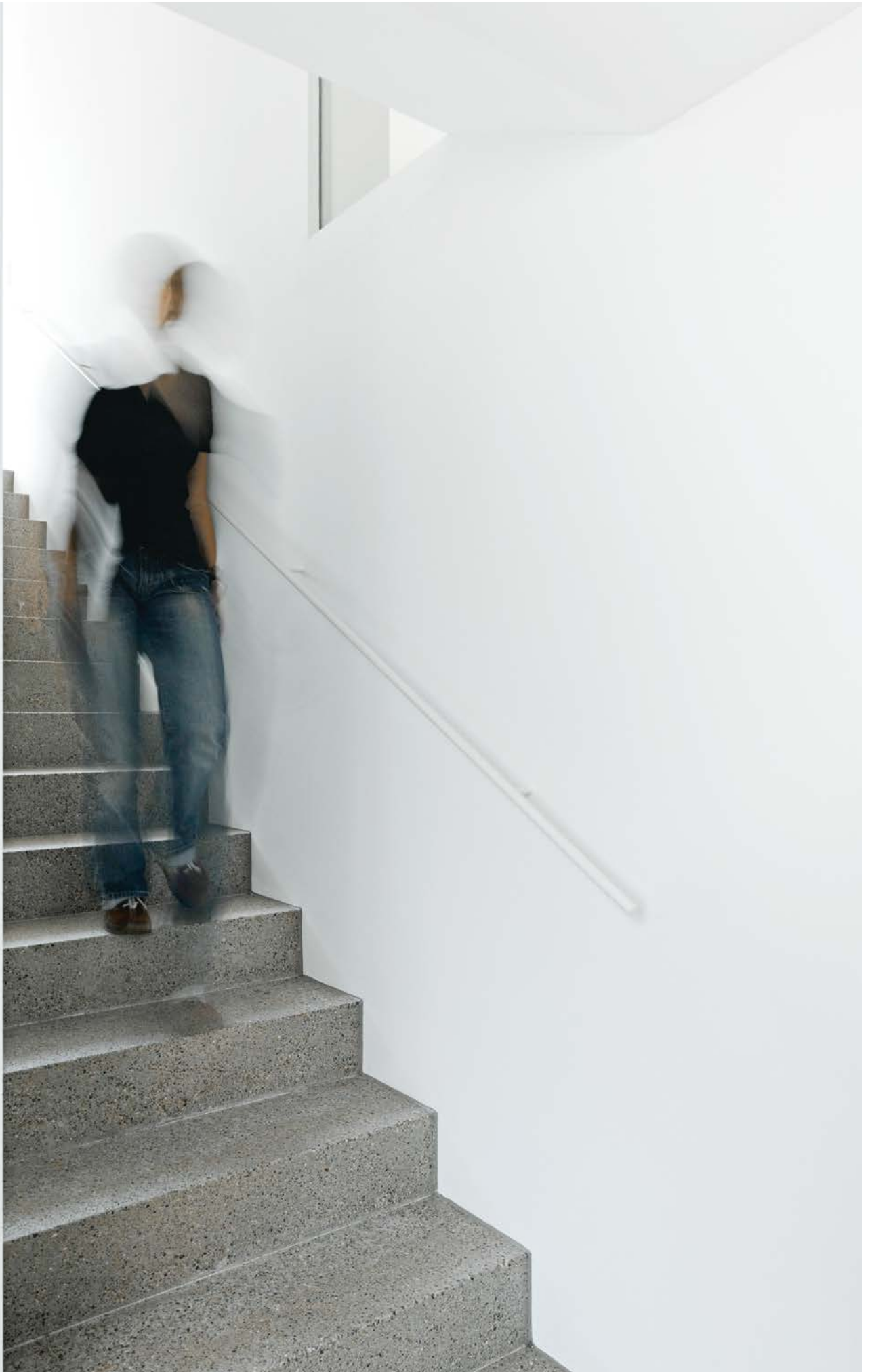

as a standard light switch



Easy and convenient: Open and close blinds and shutters with a finger



## The multi-talent for building technology

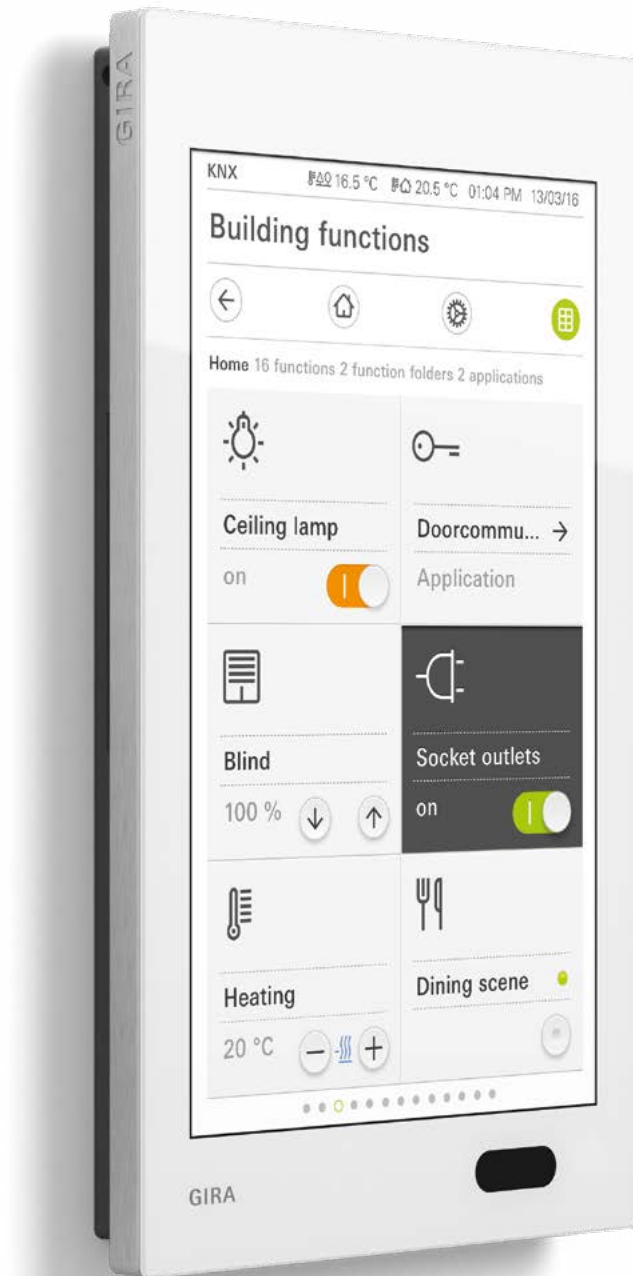

**The Gira G1:** From lighting and blinds control and setting the room temperature to online weather forecast and door communication – the new Gira G1 is the all-in-one intelligent user interface for KNX building technology. All the functions can be conveniently operated by swiping or touching the

brilliant multi-touch display. In combination with the Gira DCS IP gateway, the Gira G1 can also be used as a home station for door communication. It can be installed on a single flush-mounted box like a normal switch and is equally suitable for modernisation, retrofitting, and new buildings.

## High quality and precision

**Materials and workmanship:** Selected materials underline the high-quality design of the Gira G1. The continuous front panel is made of scratch-resistant 1 mm special glass. Thanks to its precision bonding, it forms a single unit with the housing. The high-quality metal frame gives the Gira G1 an attractive appearance, even from the side. The glass fibre-reinforced holding frame ensures permanent stability on the wall.



Flat, compact, elegant



**Design:** With its delicate look, the Gira G1 almost appears to float on the wall. High-quality materials underline the pure, sophisticated design. Because it is available in white or black, the Gira G1 harmonises well when integrated in different

residential environments. The Gira G1 has received multiple international awards for innovative and high-quality design as well as for its interface.



## Thoughtful design down to the smallest detail



**Theft protection [3]:** The integrated theft protection ensures that the Gira G1 cannot simply be removed from the wall and stolen without tools.



**Speaker [1] and microphone [2]:** The Gira G1 has a speaker and a microphone and can be used as an audio-visual home station in a Gira door communication system. Speaker and microphone are subtly integrated in the housing. High-performance echo compensation ensures good communication between indoors and outdoors.

**Proximity sensor [4]:** The Gira G1 detects when a person approaches the device and switches the display on automatically. When the Gira G1 is not used, the display switches off. This saves electricity and is an energy-efficient solution.

Simply brilliant



**The display:** The brilliant 15.25 cm [6"] TFT colour display provides an extremely clear representation of images, graphics, and text. The Gira G1 is easily legible from all viewing angles

so that it can be used equally well by both tall and short people. All the functions can be controlled simply with the touch of the finger or palm or by swiping on the sensitive touch surface.



## Clear, intuitive, user-friendly

**The Gira Interface:** The intuitive Gira Interface is an entirely new development which makes operating building technology and door communication easier than ever before. The clear design offers easy access to all functions. The user-friendly display with large font and easy-to-understand symbols of the new Gira icon system ensure clarity. The Gira Interface has received several awards for good design and usability.

### Status bar

The status bar provides key information like time, date, and outside and room temperature at all times.

### Functional overview

All functions can be displayed as tiles in the functional overview. Central functions such as an on/off switch or adjusting the room temperature can be operated directly in this view. In addition, individual functions can be bundled in a function folder, e.g. for all the functions in one room.

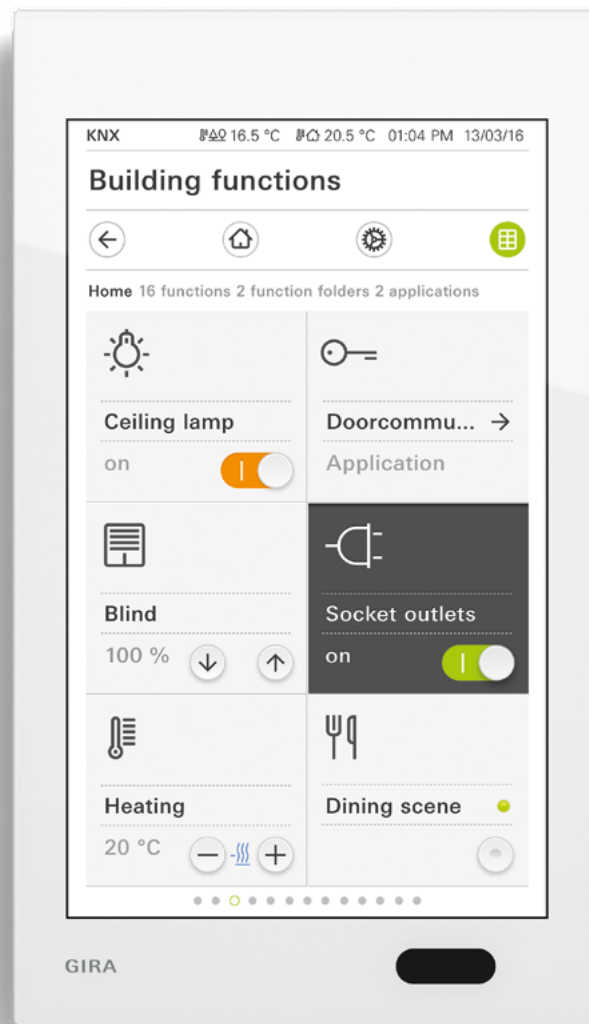

### Navigation bar

The central features can be accessed by touching the horizontal navigation bar: function overview, home screen, settings and a back key.

## As easy as a switch

**Operation:** With its large multi-touch display, the Gira G1 is convenient to use. From the functional overview, the user can navigate to the detailed view with a touch of the finger, where all features of the relevant function are available on the entire display. A swipe of the finger allows the user to jump from one function to the next – as if there were various switches lined up on the wall. Door communication and the weather forecast can also be called up from the functional overview.

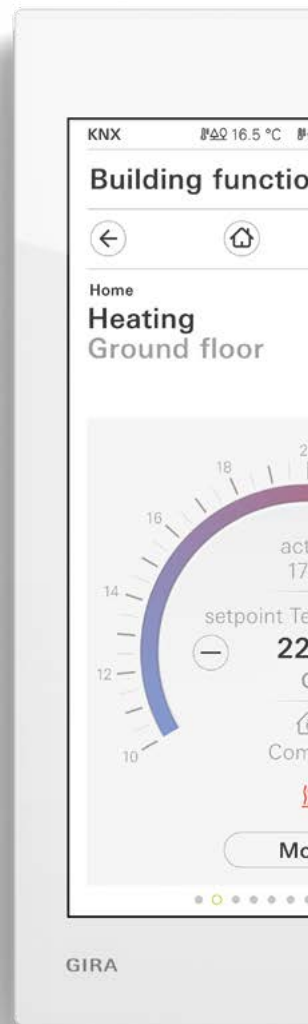
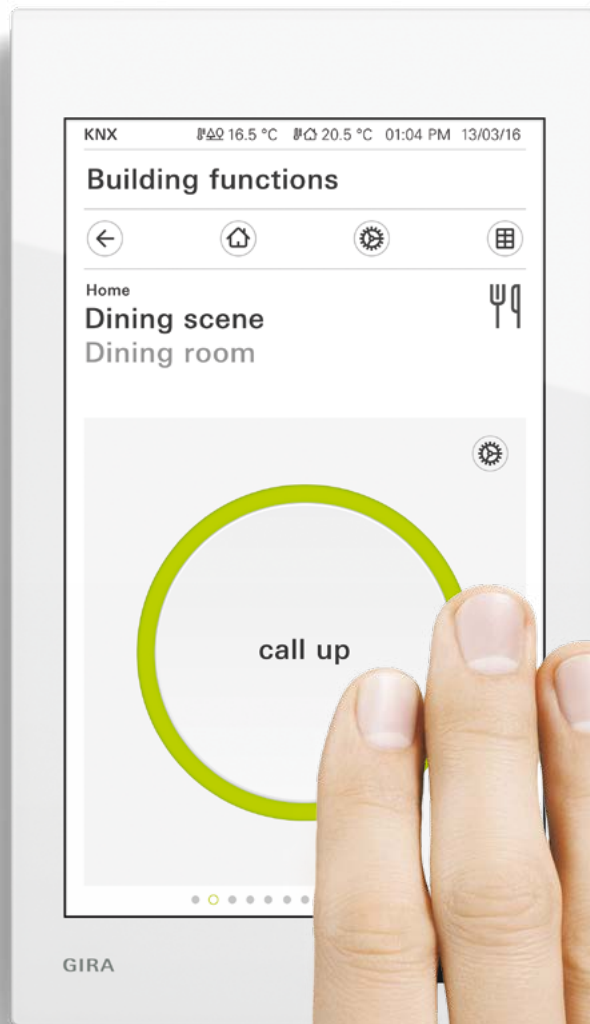

## Door communication in elegant style

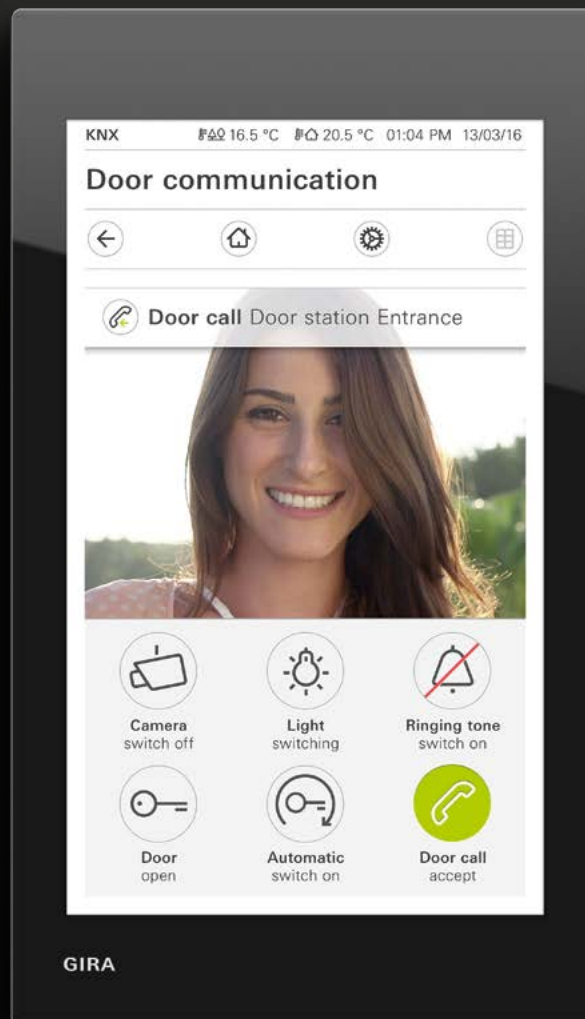

**Gira G1 as a home station:** When combined with the Gira DCS-IP-gateway and a Gira door station with colour camera, the Gira G1 can be used as a complete home station. A camera image automatically appears in the display when the doorbell rings. At the touch of a finger, the door can be opened, or the light can be switched on. Features like direct access to favourite functions and the integration of images from several

cameras that can be cycled through by swiping on the screen make door communication even more convenient. On one hand, the functionality of the home station can be integrated in the features of the Gira G1 as a KNX room operating device. On the other, the Gira G1 can also be used as an independent home station as part of the Gira door communication system.

## Building technology in a 9 × 16 cm format

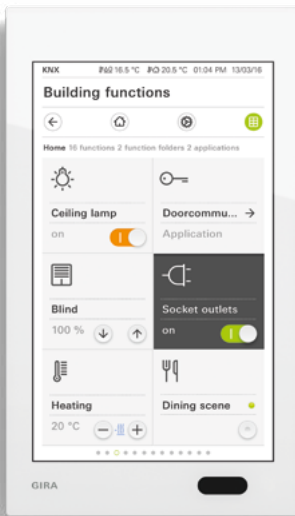

### Functional overview

All functions can be displayed as tiles in the functional overview. Central functions such as an on/off switch, controlling blinds and shutters, or adjusting the room temperature can be operated directly in this view.

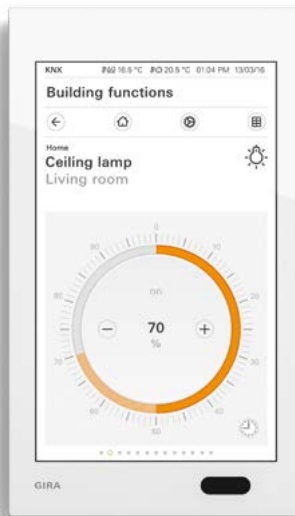

### Lighting control

Switching lights on and off, or dimming it to exactly the desired setting: With the Gira G1, lighting can be controlled with maximum flexibility. Several switch and dimmer templates are available for the various requirements.



### Room temperature auxiliary unit

In conjunction with a Gira KNX push button sensor 3 Plus or a KNX CO<sub>2</sub> sensor, the Gira G1 can be employed as a room temperature auxiliary unit. The relevant room temperature is displayed continuously in the status bar. Preset temperatures can be called up using various operating modes, such as Comfort or Night.

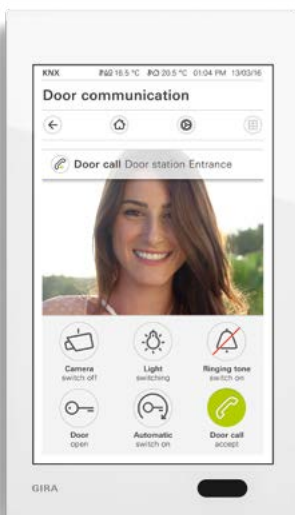

### Door communication

When combined with the Gira DCS-IP-gateway and a Gira door station with colour camera, the Gira G1 can be used as a home station. Features like direct access to favourite functions and integration of several cameras make door communication even more convenient.



### Function folder

Individual functions can be bundled in a function folder, e.g. all the light functions, to provide a better overview. Function folders offer the possibility of illustrating a simple building structure.



### Weather forecast

The online weather forecast can also be called up via the Internet. Find out in the morning whether to pack an umbrella for the day.



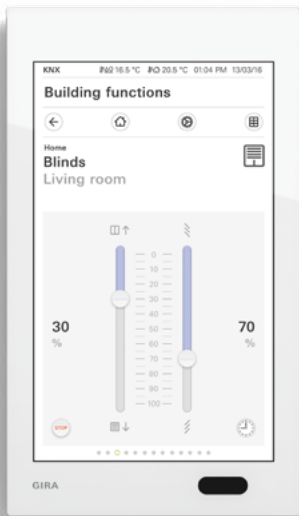

### Blinds control

Opening and closing blinds or shutters, or positioning them at a predefined height, and moving slats to the desired position: With the Gira G1, the user has everything under control.

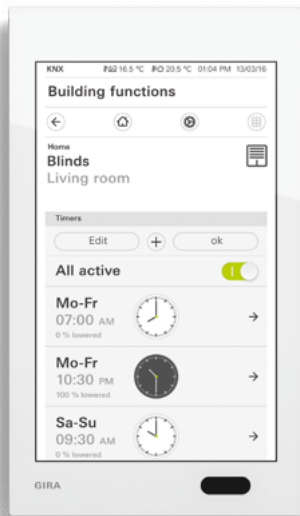

### Timers

The timer is convenient to operate and can be used to control many functions. It allows certain functions to be triggered at a specified time every day or only on certain days. For example, blinds can automatically be opened in the morning and closed in the evening.

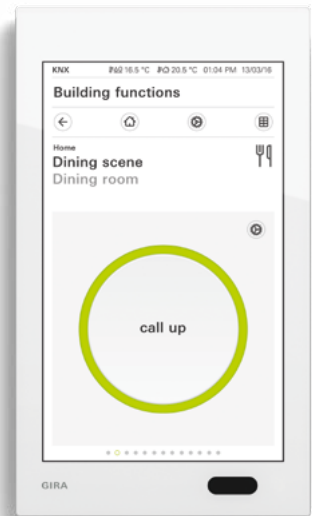

### Calling up scenes

The perfect room ambiance includes the right light, the ideal temperature, appropriate privacy protection, and perhaps music in the background: The desired mood can be called up directly at the touch of a finger using the Gira G1.

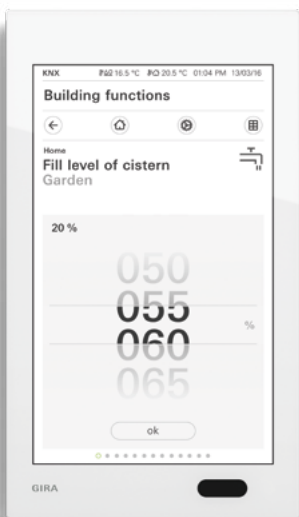

### Value transmitter

Predefined settings to control the blinds and heating: The value transmitter sends settings to the KNX system; the external devices evaluate these settings and execute the relevant functions.



### Direct function

Placing your hand on the display allows a predefined function to be called up directly. In this way, the Gira G1 becomes a simple switch, e.g. to turn the ceiling light on and off. The direct function is displayed over the screen which is currently active.

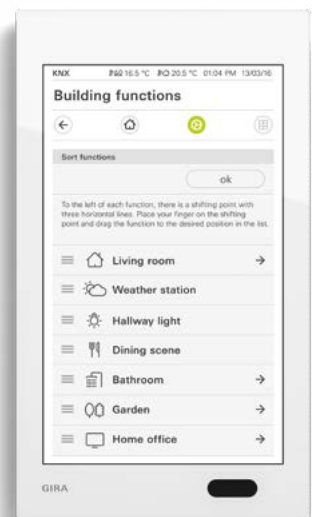

### Customisation

The interface can be adapted to the requirements of users, e.g. functions can be compiled to create personal favourites or the sequence can be changed.

## LAN or WLAN

**IP technology:** The Gira G1 offers maximum flexibility and next-generation compatibility. It is equally suitable for new buildings, modernisation and retrofitting. All functions are implemented via Internet Protocol (IP) in all application scenarios. Gira G1 is connected via a LAN cable or wirelessly via WLAN and a suitable interface (KNX IP router and/or Gira DCS IP Gateway) to the building technology – as the situation in the building demands it.



**LAN connection:** For new buildings or existing networks. For new buildings or buildings with existing networks, LAN connection is recommended. This is the most stable and reliable connection type.



**WLAN connection:** For modernisation and retrofitting. During refurbishments and modernisations, connection via WLAN is the ideal choice for simple retrofitting without construction work.

## Gira G1 as a KNX room control device

### User-friendly control of all building technology functions

As a control device for an existing or newly installed KNX system, the Gira G1 can provide many of the building technology functions. The connection is not made via KNX TP (twisted pair) as usual, but via the network (KNXnet/IP). With its various connection modules, it is suitable for the requirements of new buildings as well as for modernisation and retrofitting. It can be installed wherever it is needed and the necessary connections are available.

### Gira G1



### Gira KNX IP router

Connects the Gira G1 to the KNX installation via IP.



### Gira KNX installation



### Integration of Gira door communication

Combined additionally with the Gira DCS IP gateway, the Gira G1 is able to provide all functions of the Gira door communication system: Door communication can be integrated in the functional scope of the room operating device, and the Gira G1 becomes a full-featured home station.

### Gira G1

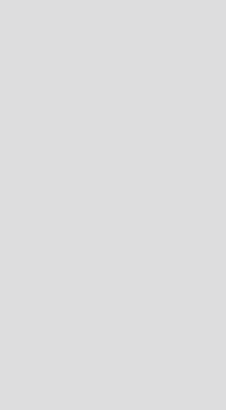

### Gira DCS IP gateway

Provides the connection between the Gira G1 and the Gira door communication system.

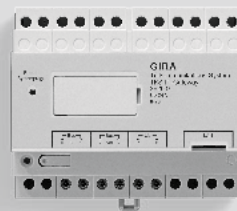

### Gira door communication system installation

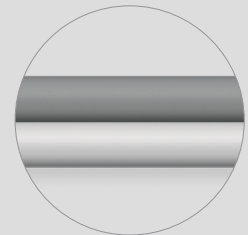

## Gira G1 as a home station

### More convenience and better security in door communication

The Gira G1 can also be used as a pure home station to offer all the functions of the Gira door communication system. This requires only a Gira DCS IP gateway.

### Gira G1



### Gira DCS IP gateway

Provides the connection between the Gira G1 and the Gira door communication system.

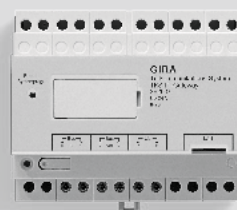

### Gira door communication system installation

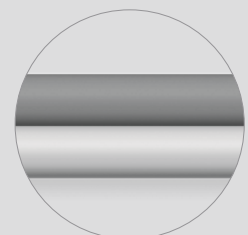

## Networking and power supply with WLAN connection

### For modernisation and retrofitting

During refurbishments and modernisations, connection via WLAN is the ideal choice for simple retrofitting without construction work.

### Easy replacement of push button sensors

With the 24 V WLAN module, the Gira G1 can be installed in the flush-mounted box of an existing push button sensor for the KNX system. New operating convenience can be realised easily.

### Reliable KNX communication via WLAN

To ensure faultless KNX communication in a wireless network at all times, a Gira KNX IP router (version 3 and above) is required. The router must be equipped with an additional "KNX Reliable Communication" function. Existing Gira KNX IP routers (order no. 2167 00) can be upgraded with the additional function.

### Gira G1



### 230 V flush-mounted connection module

Suitable for modernisation. Power supply is via the 230 V mains network.

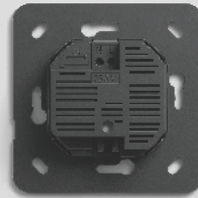

230 V 50/60 Hz

### 24 V flush-mounted connection module

Suitable for replacement of a KNX push button sensor. Power supply can be via the free wire pair of the KNX cable.

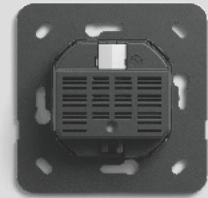

24 V

## Networking and power supply with LAN connection

### For new buildings or existing networks

For new buildings or buildings with existing networks, LAN connection is recommended. This is the most stable and reliable connection type.

### Gira G1



### PoE flush-mounted connection module

Suitable for direct connection to a network cable, which is also used for power supply.

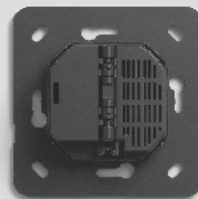

## Installation and start-up

### Easy installation in three steps

Installation is extremely simple: This Gira G1 is simply installed in an off-the-shelf flush-mounted device box. Installation is in three steps. The three parts of the Gira G1 (connection module, mounting frame, display) are separately packaged: This ensures optimum protection and maximum flexibility for installation.

### Additional information

For more information about installing the Gira G1 please see the installation instructions.

### Device box

The Gira G1 can be installed on a standard deep device box (recommended: electronics box for LAN connection), available for European and British standard.



Flush-mounted device box (Europe)

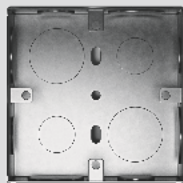

British Standard flush-mounted device box

### Connection module

The flush connection module is installed in the device box.

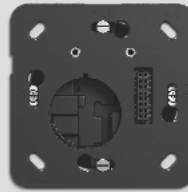

### Mounting frame and display

A holding frame is fixed on the flush-mounted connection module and attached the wall. All that remains to be done is to snap the display on the mounting frame.



## Convenient start-up

### Ready for operation quickly

At initial start-up, the Welcome Wizard guides the user through the first steps. With KNX building functions, set-up is via ETS from version 4.2. The additional functions of weather forecast and door communication are set up at the device itself.

### Training videos

The Gira Academy provides training videos for KNX configuration and setting up the door communication on the Gira G1. [academy.gira.com](http://academy.gira.com)

### Language selection

In a first step, the desired language can be selected from 22 available options.



### Application type

The application type is selected in a further step: KNX room operating device or pure home station.



### Connection type

The connection type is then defined: LAN or WLAN.



# Topology

## LAN

Connection via the flush-mounted PoE connection module.

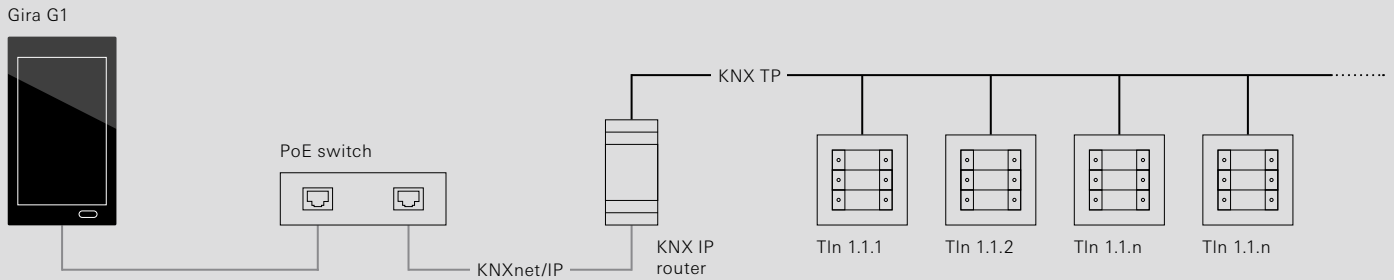

## WLAN

Connection via the flush-mounted 230 V or 24 V connection module. KNX Reliable Communication to ensure faultless KNX communication via WLAN.

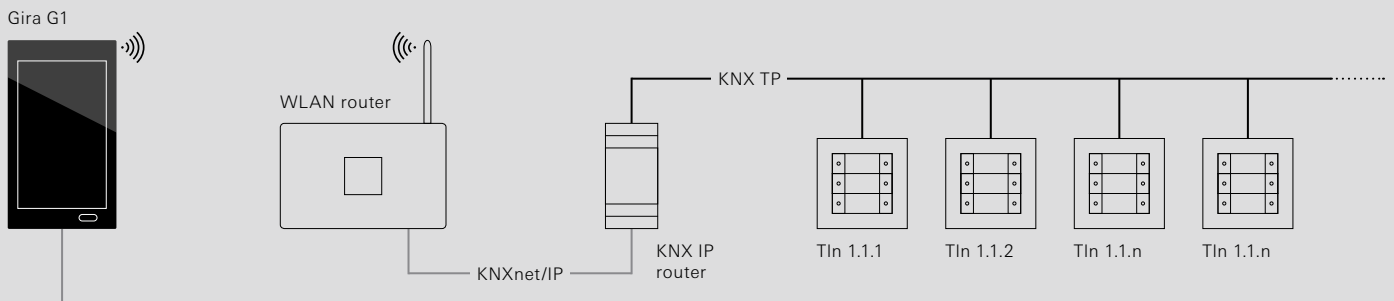

## Building with several KNX lines

KNX Reliable Communication to ensure faultless KNX communication via WLAN

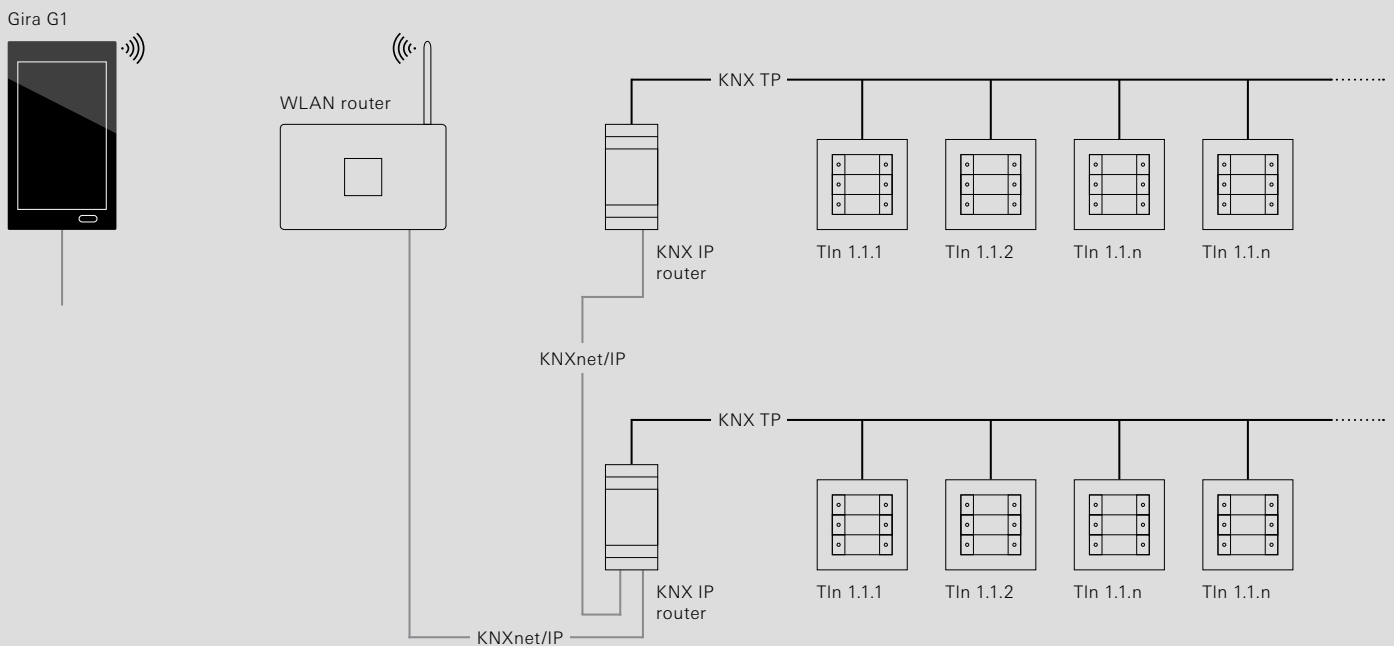

Reliable communication: To ensure faultless KNX communication in a wireless network at all times, a Gira KNX IP router (version 3 and above) is required, specially equipped with an additional "reliable KNX communication" function. Existing Gira KNX IP routers can be upgraded with the additional function.

**Gira G1 as a PoE home station in a door communication system**

Connection via the flush-mounted PoE connection module.

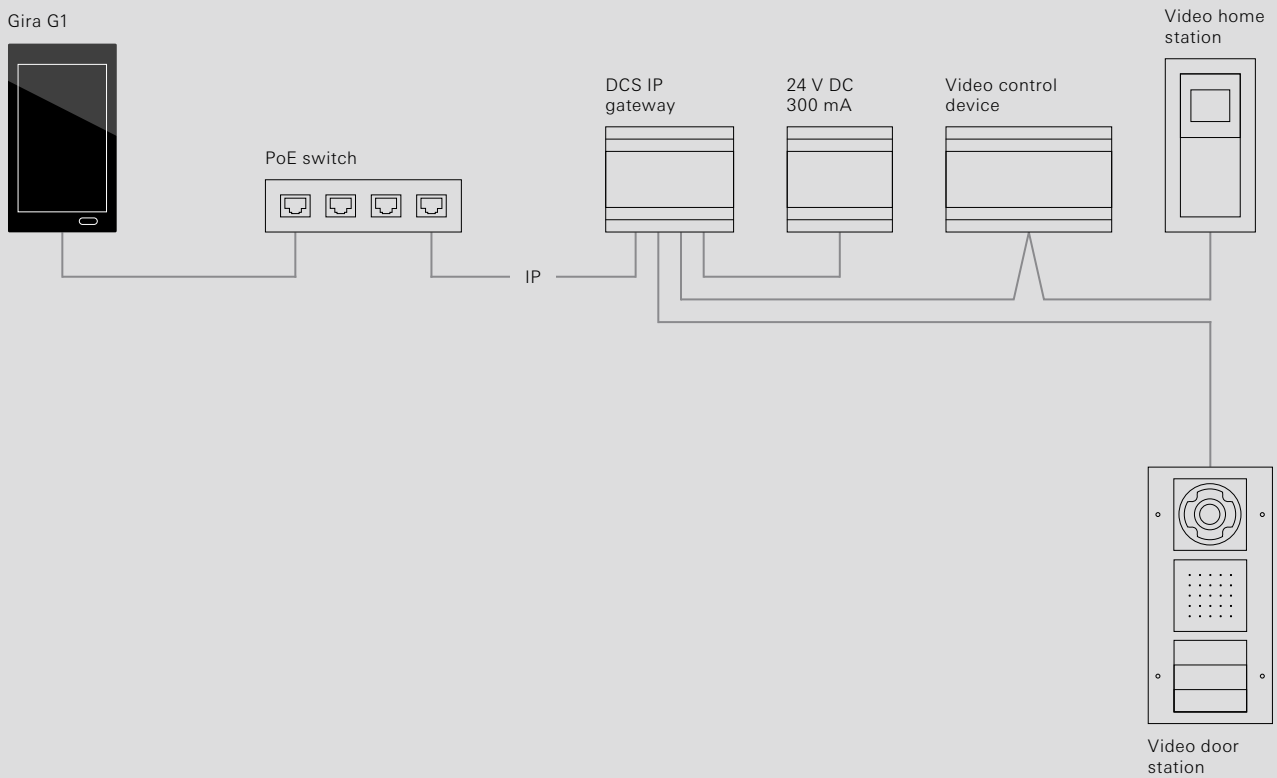

**Gira G1 as a PoE version in the KNX with door communication**

Connection via the flush-mounted PoE connection module.

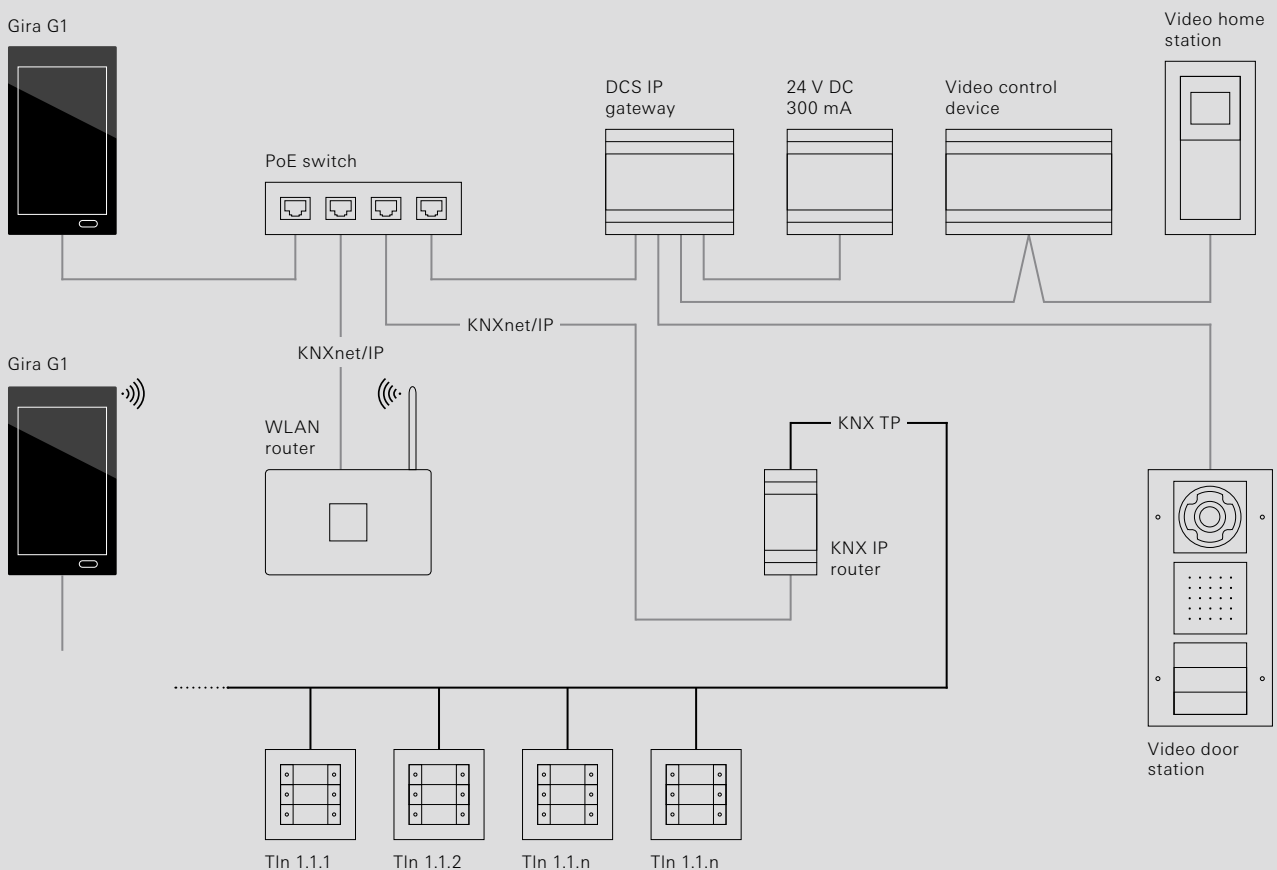



## Technical data

### Colours

Black

white



### Dimensions

Width x Height 97 mm x 168 mm

Depth (incl. flush-mounted power supply unit) 47 mm

Installation height (from wall) 15 mm

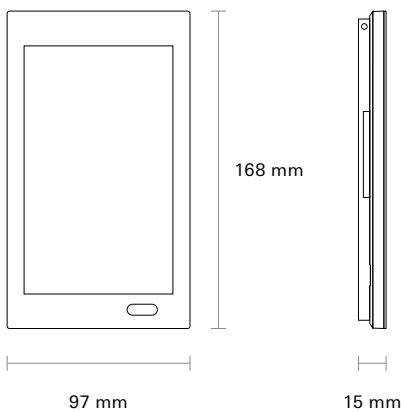

### Display

Type TFT

Diagonal 153 mm (6")

Resolution 480 x 800 px (WVGA), 155 ppi

16.7 million colours

Brightness 350 cd/m<sup>2</sup>

Contrast ratio 1:500

Viewing angle > 80° all around

### Proximity sensor

Range max. 50 cm

Capture angle 30° horizontal, 30° vertical

### Power consumption

Maximum 7 W

Minimum 2 W

Typical 4 W

### Power over Ethernet (PoE) connection module

Recommended cable Cat5e up to Cat7

Rated voltage DC PoE 48 V [36 to 57 V] class 0

Protection class III [SELV]

LAN standard IEEE 802.3af

### 230 V connection module

Rated voltage AC 230 V ± 10 %

Protection class II

Mains frequency 50/60 Hz

WLAN standard IEEE 802.11b/g/n – 2.4 GHz

### 24 V connection module

Rated voltage 24 V AC/DC

Supply range 10 to 31 V AC/DC

Protection class III [SELV]

WLAN standard IEEE 802.11b/g/n – 2.4 GHz

Connection cable Wire diameter 0.6 to 0.8 mm

Protection type IP 21

### Temperature ranges/humidity

Operating ±0 °C to +45 °C

Storage/transport –20 °C to +70 °C

Rel. humidity max. 95 % r. F., no condensation

### Scope of supply

The device is available in the versions Power over Ethernet, 24 V WLAN, 230 V WLAN, each in white or black colour. The packaging enables single removal for maximum installation flexibility. Connection materials are included with the device.

### Required accessories

- Gira KNX IP-Router for integration in a KNX system

- Gira DCS IP gateway for integration in a Gira door communication system

---

## Gira G1 features

---

The Gira G1 is a multi-functional room operating device for the visualisation and operation of a wide variety of building functions for use in the KNX system and in the Gira door communication system.

---

- Operation is via a swipe-capable multi-touch display.
  - Connection and communication are via LAN or WLAN depending on the version.
  - integrated loudspeaker
  - integrated microphone with echo compensation
- 

## Features as a KNX room operating device

---

- Intuitive user interface that can be adapted by the end user
  - Switching, dimming, blind and shutter control, value transmitter, scene auxiliary unit
  - Status display, display of date and time, display of indoor and outdoor temperature
  - up to 125 functions (five function folders or rooms with up to 25 functions each)
  - up to 125 seven-day timers with 10 switching times each
  - DPTs value transmitter: 5.010, 6.010, 5.001, 5.004, 9.001
- 

## Features as a KNX room temperature controller auxiliary unit

---

- Use as a room temperature controller auxiliary unit in combination with KNX 3 Plus push button sensor or KNX CO<sub>2</sub> sensor for room temperature measurement and control
  - Operating mode switching: comfort, standby, night, and frost or heat protection
  - Operating modes can be adapted individually
  - Comfort extension via a presence button
  - heating timer as seven-day timer with 28 switching times
- 

## Features as a video home station

---

- Camera switching: specific selection of connected colour cameras
  - Control of the door opener
  - Switching the ringtone on and off
  - 10 ringtone options can be selected
  - Call acceptance
  - Volume setting of ringtone and voice volume
- 

## Integration of Internet services

---

- Gira weather forecast: Display of weather data for up to five locations
- 

---

## Notes

---

- Suitable for indoor use only
  - Recommended installation height: 150 cm above floor
  - Installation is on a deep device box (an electronics box is recommended for a LAN connection).
  - Communication with the KNX installation is exclusively via the KNX net/IP standard.
  - A KNX IP router must be used to connect the Gira G1 PoE to the KNX installation. Several Gira G1 units can be operated on one KNX IP router.
  - In order to ensure reliable communication via WLAN, a Gira KNX IP router (version 3 and later) is required to connect the Gira G1 230 V or Gira G1 24 V to the KNX installation. For this purpose the Gira KNX IP router (version 3 and later) is specially equipped with the additional function "KNX Reliable Communication". Several Gira G1 units can be operated on one Gira KNX IP router (version 3 and later).
  - Set-up in the KNX system with ETS 4.2 or higher.
  - Can be used as a home station in combination with the DCS IP Gateway.
  - When planning the system, please observe the technical information on network planning in the device documentation.
- 

## Design awards

---

- iF Design Award 2015
  - German Design Award 2015
  - Good Design Award 2014
  - ICONIC Awards 2014
  - Plus X Award 2014 for high quality, design, operating convenience, and functionality
  - Design Plus 2014
  - ADC Award 2015
  - Red Dot Award 2014, Best of the Best
- 

## Product design, interface design

---

schmitz Visuelle Kommunikation, Wuppertal

---

## Warranty

---

The warranty is provided in accordance with statutory requirements via the retailer. Please deliver or send faulty devices postage paid and with an error description to your sales representative (retailer/installation company). The salesperson will forward the devices to the Gira Service Center.

---

Gira  
Giersiepen GmbH & Co. KG  
Electrical installation  
systems

Industriegebiet Mermbach  
Dahlienstraße  
42477 Radevormwald

P.O. Box 12 20  
42461 Radevormwald

Germany

Phone +49 2195 602-0  
Fax +49 2195 602-119

[www.gira.com](http://www.gira.com)  
[info@gira.com](mailto:info@gira.com)

Gira Service number:  
+44 203 301 1234



[www.gira.com](http://www.gira.com)  
Gira products and much more  
on the topic of intelligent building  
technology.



[www.gira.com/newsletter](http://www.gira.com/newsletter)  
Subscribing to the Gira newsletter  
will always keep you up to date.



[www.gira.com/references](http://www.gira.com/references)  
Diverse reference properties  
featuring Gira solutions.



[www.gira.com/systemintegrators](http://www.gira.com/systemintegrators)  
Find information on the concept  
and a system integrator near you.



[www.gira.com/architects](http://www.gira.com/architects)  
The Gira architect service specifically  
responds to the concerns of architects  
and planners.



[www.gira.com/download](http://www.gira.com/download)  
Operating instructions, software,  
brochures and more.



[www.catalogue.gira.com](http://www.catalogue.gira.com)  
The Gira online catalogue includes all  
the items in the Gira product range and  
enables simple creation of parts lists.





Published by:  
Gira Giersiepen GmbH & Co. KG

Concept, design, editing,  
Product visualisation:  
schmitz Visuelle Kommunikation  
www.hgschmitz.de

Picture credits:  
p. 05 Lara Swimmer Photography  
p. 06–07 Jonas Bjerre-Poulsen/  
Norm Architects  
p. 08–09 Andy Matthews/  
Artur Images  
p. 10–11 Zooey Braun/  
Artur Images  
p. 12 Andy Matthews/  
Artur Images

Lithography:  
vimago GmbH, Krefeld

Printing:  
paffrath print & medien gmbh,  
Remscheid

Subject to technical modifications

Possible colour variations between  
images in this product information  
and specific products are due to print-  
ing processes and cannot be avoided.

Printed in Germany

Gira and sustainability:  
Gira's task is acting responsibly  
and supporting the sustainable  
development of society. Therefore,  
for the production of this brochure,  
we have aspired to reduce the con-  
sumption of resources and emission  
of harmful gases while preventing  
environmental pollution as much as  
possible. We strive to reach these  
goals by using eco-friendly materials.  
The paper used has been FSC certified  
and is made of at least 60 % recycled  
paper.

Please visit the Gira sustainability  
portal for more information on our  
current activities and projects:  
[www.nachhaltigkeit.gira.de/en](http://www.nachhaltigkeit.gira.de/en)

Your dealer:

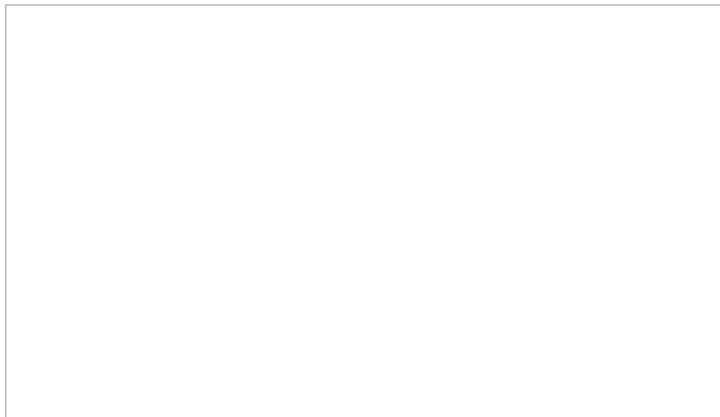

# GIRA

