

# GIRA

The Gira System 70.

## Minimalist design. Maximised possibilities.

Available from: 09/2026

Smart Home.  
Smart Building.  
Smart Life.

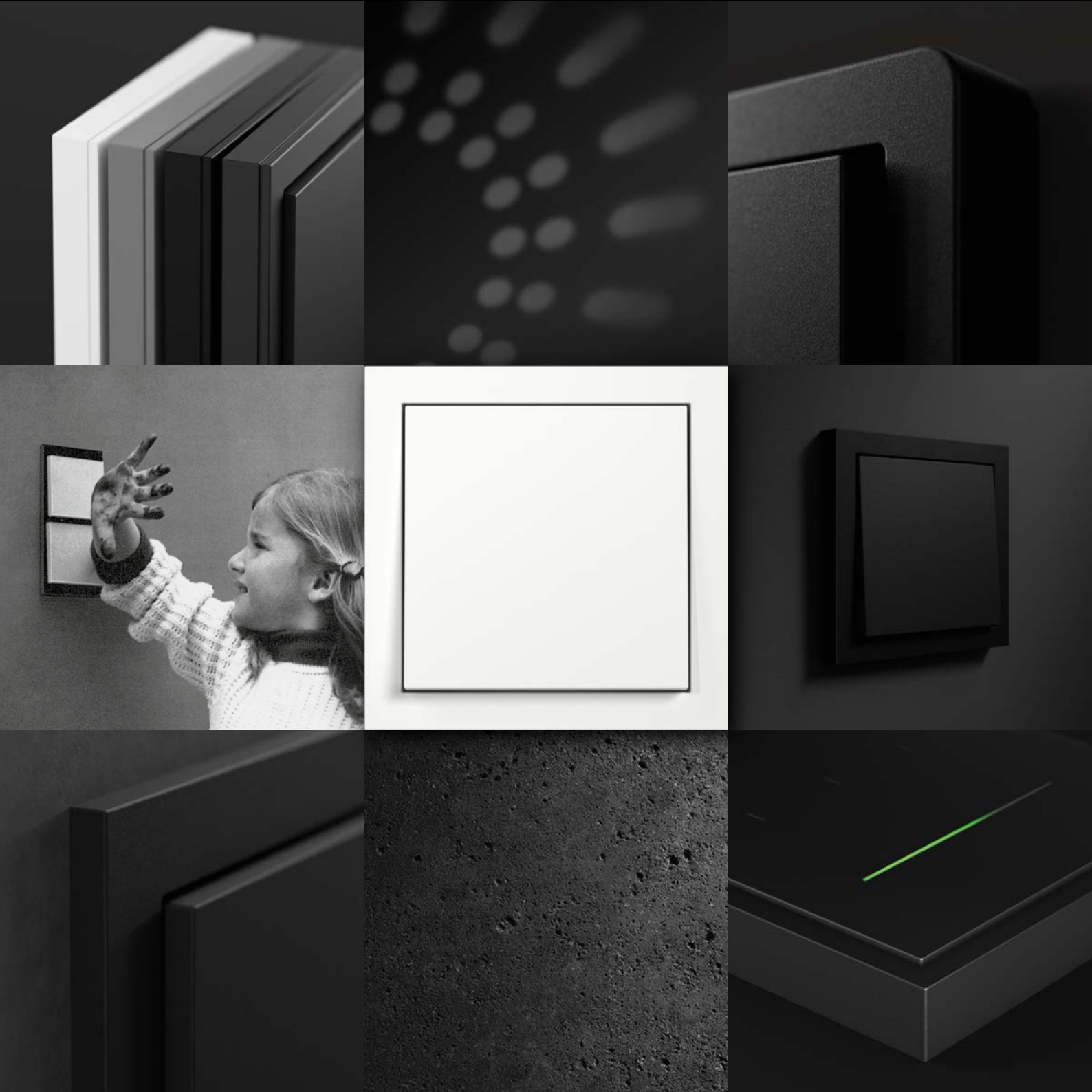

Design & function / Gira System 70

We are Gira.  
We are the ones with the switches.  
But we're so much more.

Future-oriented.  
Certified.  
Responsible.

We're the guardians, innovators,  
Smart Home pioneers, developers,  
system experts, KNX partners,  
shapers of the future, patent masters,  
award winners and designers.

But above all, we're the ones  
who listen  
to you.

Subtle, but smart.  
With a distinct focus on quality,  
materials and functions.  
And the driving force of innovation.

In our hearts, we are engineers  
on a mission to inspire  
with new technologies,  
smart applications, and  
impressive attention to detail.

We will always work our hardest  
to find the best solution for you.  
With service, design and performance  
made in Germany.

Because that is what we stand for.  
And have stood for since 1905.

---

04	_____	Gira F100 – a pioneering achievement
06	_____	Minimalist design in large format
08	_____	Gira F100
12	_____	Gira F200
16	_____	Gira F200 flat
20	_____	Gira F300
26	_____	A diverse range of products
28	_____	Pushbutton sensor 4.70
30	_____	Room climate sensor for KNX
32	_____	System 3000 touch top unit
34	_____	Services
36	_____	Sustainability

---

# From switch to system over a period of 60 years: the Gira F100 gives rise to the Gira System 70.

In 1966, we introduced a new type of switch to the German market: the first F100. The unique design feature of the switch was its rocker. A pioneering achievement in product design. In the decades that followed, we introduced the Gira F100 to our product range and continued to develop it. Other successor switches also benefited from this.

By the end of 2026, the Gira F100 will become the Gira System 70, a new and powerful platform. This will also involve significant expansion of the product range comprising three design lines, each available in five colours and for flush-mounted and surface-mounted installation, as well as a flat variant of the design line, which is also available in five colours.

The modular, forward-thinking product range – based on the same principles as the Gira System 55 – is at the cutting edge of both mechanical and electronic technology.

---

01



02

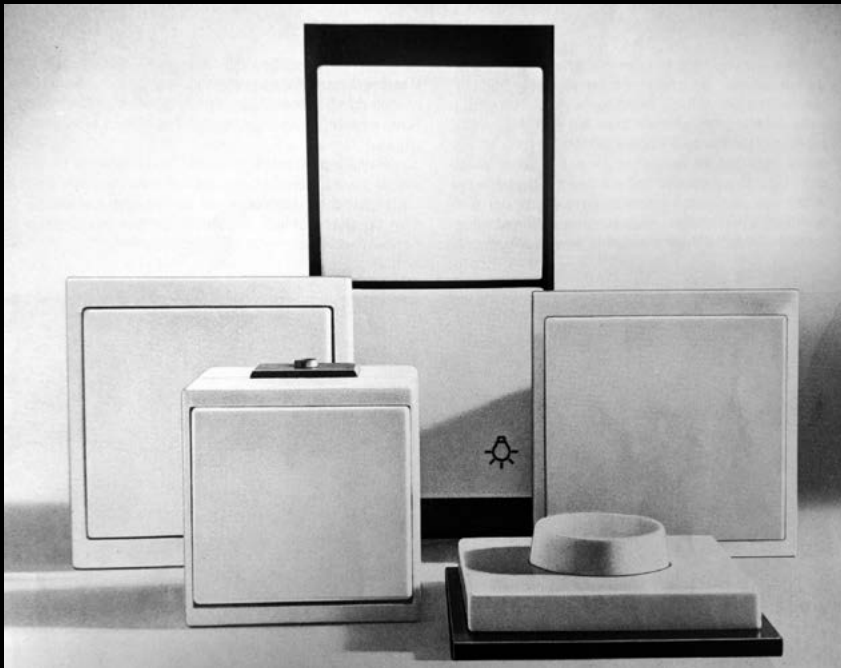

03



04

01–03 Gira F100 advertising  
photography, 1966  
04 Product image for  
the Gira F100 facelift,  
2024

# The seamless continuation of an iconic design language.

Our products are known for their minimalist design language and are easily recognised. This iconic design represents a decades-long mission to achieve something that is easier said than done: reduction to the bare essentials.

This has already been showcased by the Gira System 55, a platform that represents Gira's clear design language at the intersection of design and function.

These clear contours, surfaces and colours have now been scaled to 70 x 70 mm within a single platform with the new Gira System 70.

New, independent design lines have been developed for this purpose: Gira F200, Gira F200 flat and Gira F300. The product range is based on the current version of the proven Gira F100.

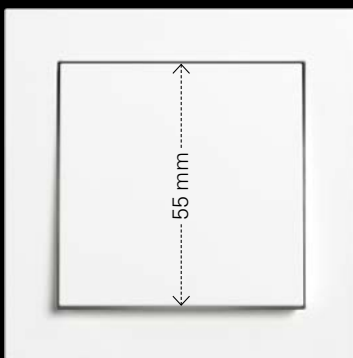

Gira E2 from the System 55

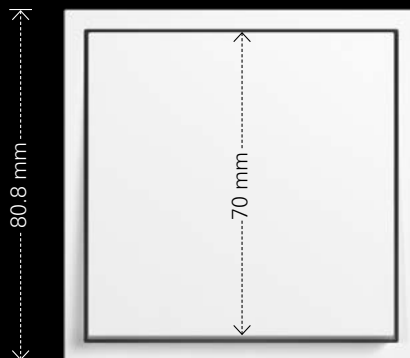

Gira F300 from the System 70

The slimmest frame variant, Gira F300, is based on the familiar outer outline of the Gira E2.

The Gira System 70:  
one platform, four visually  
coherent design lines.

The four design lines in  
the new Gira System 70  
set new standards in terms  
of design, haptics and  
design freedom in building  
technology. With its large,  
planar surfaces, the  
System 70 meets the most  
exacting aesthetic  
requirements and blends  
seamlessly into diverse  
architectural styles.



Gira F100



Gira F200



Gira F200 flat



Gira F300

System 70 / Gira F100

## Gira F100. Proven design with soft contours.

The Gira F100 design line is characterised by its soft design language with a characteristic corner radius.



System 70 / Gira F100

# Gira F100 in detail.

More information  
on the Gira F100:



The flush-mounted variant of the Gira F100 design line is available in the five Gira system colours.

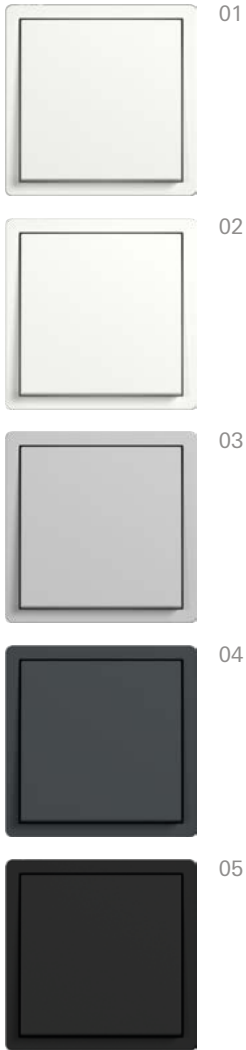

- 01 Pure white glossy
- 02 Pure white matt (lacquered)
- 03 Grey matt (lacquered)
- 04 Anthracite (lacquered)
- 05 Black matt (lacquered)



The Gira F100 is available as a 1-gang to 3-gang surface-mounted variant and in colours matching the usual cable channel colours.

Surface-mounted colour variants:

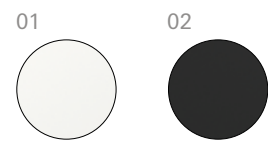

- 01 Pure white glossy
- 02 Black matt (lacquered)

Frame variants:

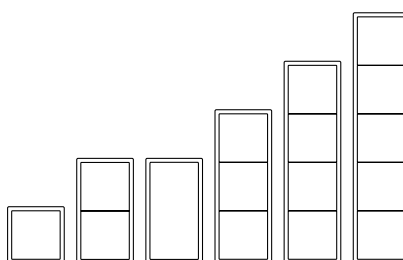

Suitable for vertical and horizontal installation.

System 70 / Gira F200



## Gira F200. Independence with clean lines.

The Gira F200 design line is characterised by its straight-line shape with a design-defining shadow gap all the way round.

System 70 / Gira F200

# Gira F200 in detail.

More information  
on the Gira F200:



The Gira F200 is available as a 1-gang to 3-gang surface-mounted variant and in colours matching the usual cable channel colours.

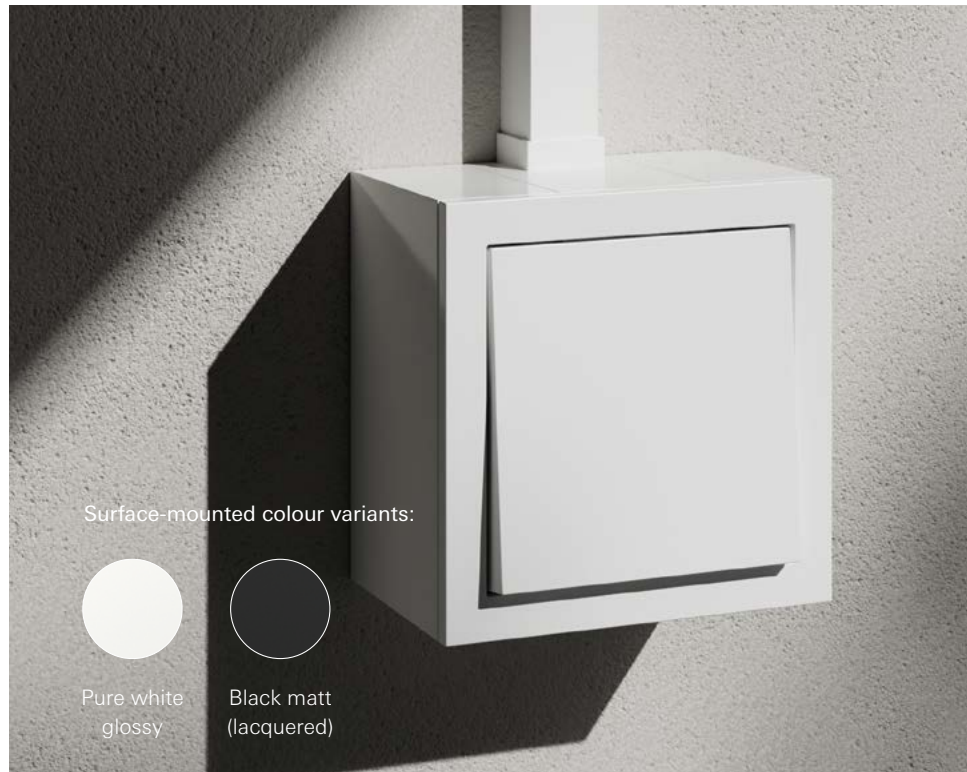

01

02

03

The flush-mounted variant of the Gira F200 design line is available in the five Gira system colours.



04

05

- 01 Pure white glossy
- 02 Pure white matt (lacquered)
- 03 Grey matt (lacquered)
- 04 Anthracite (lacquered)
- 05 Black matt (lacquered)

Frame variants:

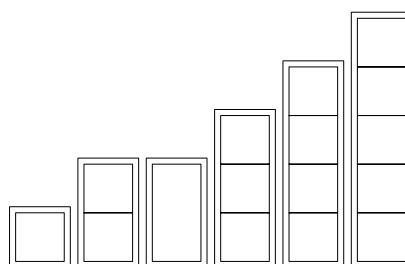

Suitable for vertical and horizontal installation.

# Gira F200 flat. Minimal height conveying a strong design statement.

With its extremely flat profile height of just 3 millimetres and simple mounting with its own device boxes, the Gira F200 flat design line is a high-quality solution for particularly understated electrical installations that convey a strong design statement.



# Gira F200 flat in detail.



The flush-mounted variant of the Gira F200 flat design line is available in the five Gira system colours.



01



02



03



04



05

- 01 Pure white glossy
- 02 Pure white matt (lacquered)
- 03 Grey matt (lacquered)
- 04 Anthracite (lacquered)
- 05 Black matt (lacquered)

More information  
on the Gira F200  
flat:



Frame variants:

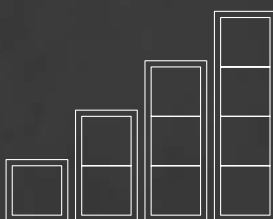

Suitable for vertical and horizontal  
installation.



The external dimensions of the frames of the Gira F200 flat, Gira F200 and Gira F200 surface-mounted are identical. This allows the designs to be combined with one other within projects in order to meet individual and structural requirements.

Two specially developed boxes for cavity walls and masonry are available within the Gira F200 flat design line to allow for flush mounting. Both box types are airtight according to DIN 18015-5 (EnEV).

This makes installation as simple as possible – and not just for the device box for cavity walls. The flush-mounted installation box can be used flexibly in combination with the corresponding device carrier for a range of plaster thicknesses up to 3 cm. This makes it particularly easy to plaster into the masonry.

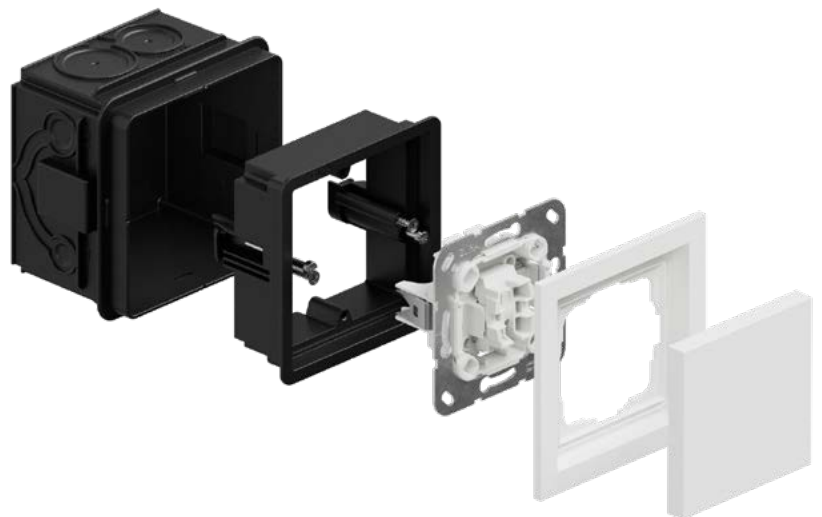

**Gira F300.  
Minimum frame,  
maximum effect.**

In the Gira F300 design line, the smaller, narrow frame with clear contours provides a particularly exciting contrast to the large operating surface.



## Gira F300 in detail.



01



02



03

The flush-mounted variant of the Gira F300 design line is available in the five Gira system colours.



04



05

- 01 Pure white glossy
- 02 Pure white matt (lacquered)
- 03 Grey matt (lacquered)
- 04 Anthracite (lacquered)
- 05 Black matt (lacquered)

Surface-mounted colour variants:



Pure white  
glossy



Black matt  
(lacquered)



The Gira F300 is available as a 1-gang to 3-gang surface-mounted variant and in colours matching the usual cable channel colours.

---

More information  
on the Gira F300:



Frame variants:

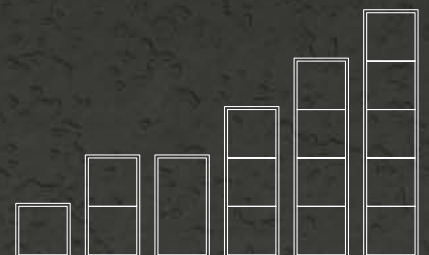

Suitable for vertical and horizontal  
installation.

System 70 / Combination in multiframes





## Functionality is at the heart of the design.

A special visual feature of the Gira System 70 is the directly adjacent functional inserts when multiframes are used. This means that no crossbars are visible between any of the frame variants, resulting in smooth transitions from insert to insert – regardless of whether they are socket outlets, pushbutton sensors or simple rockers.

---

# A cutting-edge range offering a vast array of functions.

As a platform, the new Gira System 70 can be flexibly scaled, from conventional installations with light switches, socket outlets, room temperature controllers or door communication to smart building technology that uses the Gira System 3000, Gira One or the powerful KNX Smart Home.

Meets all current and future requirements: any project can be achieved with the System 70. Based on the new generation of switches and socket outlets and equipped with the new pushbutton sensors, the System 70 offers an extensive and modern range.

The entire range can be found in the online catalogue.



A selection of what is available:

- 01 Rocker
- 02 Control rocker
- 03 Rocker with inscription space and bell symbol
- 04 Rocker, 2-gang, blind
- 05 SCHUKO socket outlet
- 06 Socket outlet with earth pin (CEBEC)
- 07 Touch top unit
- 08 System 3000 operating top unit BT
- 09 System 3000 operating top unit, memory arrow symbols
- 10 System 3000 blind timer and timer BT arrow symbols
- 11 System 3000 blind timer and timer display
- 12 System 3000 room temperature controller BT
- 13 Dimmer cover
- 14 Room temperature controller with control light
- 15 IP flush-mounted radio
- 16 Flush-mounted radio speaker
- 17 System 3000 motion detector top unit
- 18 System 3000 motion detector top unit
- 19 KNX button
- 20 Pushbutton sensor 4.70, 1-gang with inscription space
- 21 Pushbutton sensor 4.70, 2-gang
- 22 Pushbutton sensor 4.70, 4-gang
- 23 Room climate sensor for KNX
- 24 HVAC room climate sensor for KNX
- 25 Coax cover
- 26 Modular Jack cover
- 27 TAE connection box
- 28 USB power supply PD, 1-gang, type C
- 29 SCHUKO socket outlet with USB power supply, 2-gang, type A/type C
- 30 Keyless In Fingerprint



01



02



03



04



05



06

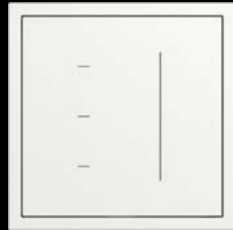

07

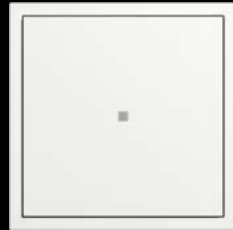

08



09



10



11



12

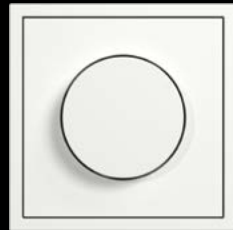

13

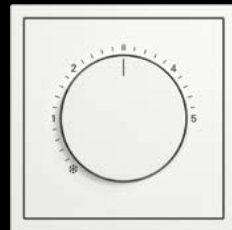

14



15

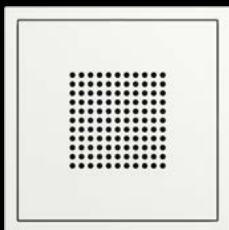

16



17



18

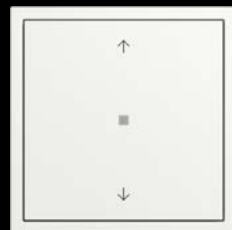

19



20

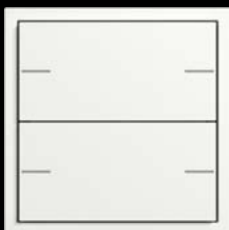

21



22



23



24



25



26



27



28



29



30

# Intelligent operation with large surface.

The award-winning Gira System 55 pushbutton sensor 4.55 represents uncompromisingly high-quality and versatile Smart Home control. The new pushbutton sensor 4.70 combines the functions of the latest generation of pushbutton sensors with the large operating surface of the Gira System 70.

The pushbutton sensor 4.70 is available as a Standard version with integrated temperature sensor and as a Komfort version with extensive sensor technology, including an air quality sensor. With up to four rockers, the pushbutton sensor 4.70 enables comprehensive control with just one device.

## Properties of the pushbutton sensor 4.70:

---

- Available in Standard (with temperature sensor) and Komfort variants.
  - Komfort variant with additional calibrated sensor technology: temperature, humidity, VOC air quality, external sensor connection.
  - Can be individually inscribed via the Gira inscription service.
  - Available for Gira One and KNX.
- 

More information  
on the pushbutton  
sensor 4.70:





System 70 / Room climate sensor for KNX

Smart comfort for a  
healthy room climate.



More information  
on the room climate  
sensor for KNX:





The room climate sensor for KNX ensures a pleasant and energy-efficient living climate, whether in a single-family home or in the office. The Standard variant offers precise temperature measurement and heating control, while the Komfort variant offers additional sensors for humidity and air quality.

#### Properties of the room climate sensor for KNX:

---

- Simple touch operation, freely configurable display and the Komfort variant allows all room climate data to be displayed.
  - Standard variant with integrated temperature sensor for automatic climate control.
  - Komfort variant with additional sensors for humidity and air quality, which enable automated room climate control.
-

# Intuitive control at the touch of a finger.

With its minimalist product design, the System 3000 touch top unit fits seamlessly into the Gira System 70 design language.

Its touch-sensitive operating surface allows you to conveniently and intuitively control lights or blinds via three touch surfaces and a touch slider.



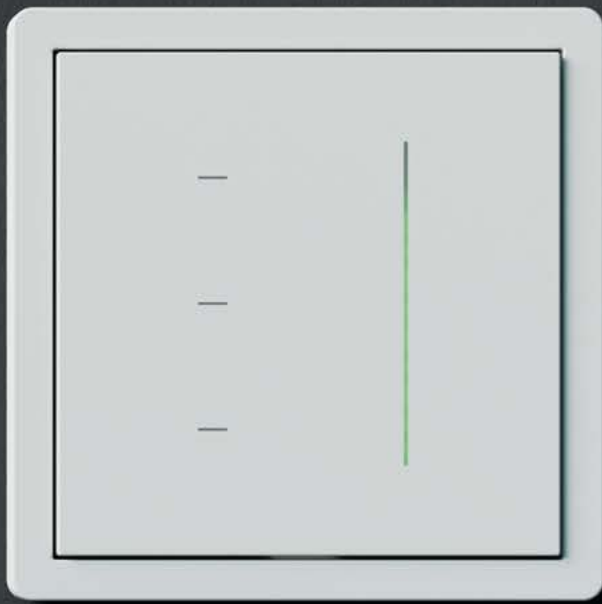

#### Properties of the System 3000 touch top unit:

---

- Touch-sensitive operating surfaces for easy switching and dimming of lights or control of blinds.
- Simple selection of various brightness levels or blind positions.
- Memory function to allow settings to be saved.
- Touch slider with narrow LED band for controlling and displaying the brightness or blind position.
- Permanent or intermittent status display.

More information  
on the System 3000  
touch top unit:



# Find solutions faster: the new Gira online catalogue.

More than just an update – this is the new must-have tool for professionals.

Every minute counts in the project business. The new Gira online catalogue immediately displays all relevant information on the screen, whether on a PC, tablet or smartphone. Products, variants, data sheets and successor items can be found in seconds, saving time and significantly simplifying project management.

Further information:  
[catalogue.gira.com](http://catalogue.gira.com)

## Properties of the Gira online catalogue:

---

- Smart search function for products and successor items, including a direct comparison between variants.
  - All planning documents, from data sheets to BIM data, available immediately, in the correct format and in one place.
  - Clear navigation, a new product overview and intuitive filters facilitate decision making and speed up project preparation.
- 





Scan the QR code to explore the Gira System 70 range.



# A big surface for big ambitions.



A circular approach.  
The Gira F100 design line is Cradle to Cradle Certified®.

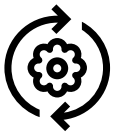

Biocircular plastics produce 72% less carbon emissions when compared with fossil-based materials.<sup>1</sup>

1905  
Made in  
Germany

Find out more about sustainability.

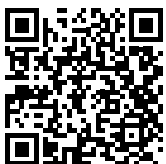

Long-term climate protection requires short-term goals. That's why we are gradually converting our new product range to reduced-carbon plastic. The frames of all four System 70 design lines in the pure white glossy colour variant are manufactured from a plant-based, low-emission material right from the start of delivery. The non-visible switch base is also made fully from recycled material.

And it is not just the material of the new Gira platform that is playing a part in our sustainability efforts: the impressive scale of our Solar Park at the Radevormwald site is also a key factor in the sustainable production of the Gira System 70.

Since June 2025, we have been producing 10 million kilowatt hours of solar power per year across an area of 70,000 square metres, which directly supplies our production site with energy. This means that there is sunshine in every Gira product.

Our careful use of resources is also reflected in our claim as to the quality and durability of our products. We have been developing and producing our system solutions in Germany since our foundation and continue to do so to this day. "Made in Germany" quality will continue to be achieved at our 30,000 square metre production, development and logistics centre in Radevormwald, which has the potential to expand.

<sup>1</sup> Comparison of product carbon footprint with fossil-based materials (cradle-to-gate)

<sup>2</sup> Comparative life cycle assessment of the production phase (A3) of substitute products according to EN 15804

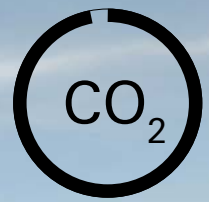

97%

fewer carbon emissions  
in the production phase  
of Gira products.<sup>2</sup>



# Being innovative means thinking beyond your own four walls.

Since 1905, we've been the ones with the switches, but we're so much more ... Because innovation is our great passion. Our pioneering spirit drives us to constantly improve and enhance the comfort of people's homes with innovative solutions.

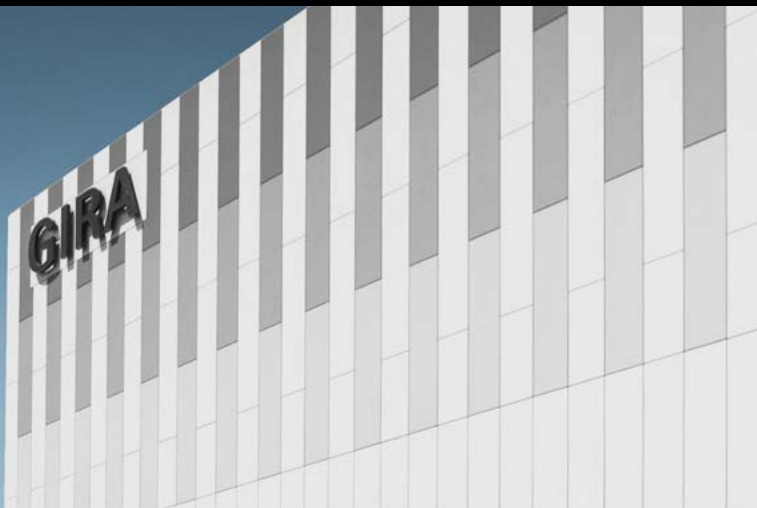

"Made by Diversity".

Gira has been manufacturing products at its location in Radevormwald for more than 100 years. The company is fully committed to the "Made in Germany" quality standard. This is what 1200 employees from 28 nations work for – each and every one of them with different talents, individual expertise, wide-ranging experiences and different life stories. This diversity, supported by shared values, provides the basis for our creativity, innovative strength and future viability.

## Innovative technology, award-winning design.

We have always aspired to combine maximum functionality and reliability with a unique design to create special user experiences. The extraordinary design quality and functionality of our products have been recognised by many internationally acclaimed awards.



Published by:  
Gira Giersiepen GmbH & Co. KG

Image credits:  
Gira symbol system  
(pages 27, 29):  
schmitz Visuelle Kommunikation  
hgschmitz.de

Subject to technical modifications.

The brochure contains an overview of Gira products. The product range may differ in each country or other specifications may apply. If you have any queries, please contact your local representative.

Any colour variations between the illustrations in this product information and the product are due to printing processes and cannot be avoided.

For us, helping to shape the future means taking sustainable business practices seriously in all areas of the company. This brochure is another way in which we are contributing to this by managing the resources we need responsibly and using environmentally compatible materials. The FSC trademarks recognises paper that comes from FSC®-certified forests managed to the highest standards, recycled materials and other controlled sources and has been independently certified.

[www.sustainability.gira.com](http://www.sustainability.gira.com)



# GIRA

Gira  
Giersiepen GmbH & Co. KG

Dahlienstrasse  
42477 Radevormwald

Postbox 12 20  
42461 Radevormwald  
Germany

Phone: +49 2195 602-0

[www.gira.com](http://www.gira.com)  
[info@gira.com](mailto:info@gira.com)

---

Order No. 18230 90 03/26 2. 22