

Issue:
23.03.2017
51423400

Push button sensor 3 Plus 2-gang
Push button sensor 3 Plus 5-gang (2+3)

Order No. 5142 00
Order No. 5145 00



Table of Contents

1	Product definition	4
1.1	Product catalogue	4
1.2	Function	4
1.3	Accessories	7
2	Installation, electrical connection and operation	8
2.1	Safety instructions	8
2.2	Device components	9
2.3	Fitting and electrical connection	10
2.4	Commissioning	14
2.5	Operation	15
2.5.1	Basic display	16
2.5.2	Menu "Setpoint"	18
2.5.3	Menu "Settings"	20
3	Technical data	31
4	Software description	32
4.1	Software specification	32
4.2	Software "Push button sensor 3 plus"	34
4.2.1	Scope of functions	34
4.2.2	Notes on software	37
4.2.3	Object table	38
4.2.3.1	Object table, push button sensor function section	38
4.2.3.2	Object table, controller function section	52
4.2.3.3	Display object table	74
4.2.4	Functional description	79
4.2.4.1	Push button sensor	79
4.2.4.1.1	General settings	79
4.2.4.1.2	Operation concept and button evaluation	80
4.2.4.1.3	Switching function	84
4.2.4.1.4	Dimming function	85
4.2.4.1.5	Venetian blind function	87
4.2.4.1.6	Value transmitter function	91
4.2.4.1.7	Scene extension function	93
4.2.4.1.8	2-channel operation function	94
4.2.4.1.9	Controller extension function	96
4.2.4.1.10	Controller operation function	97
4.2.4.1.11	Heating timer operation function	98
4.2.4.1.12	Manual fan control function	99
4.2.4.1.13	Status LED	100
4.2.4.1.14	Brightness setting	106
4.2.4.1.15	Disabling function	107
4.2.4.1.16	Alarm signalling	109
4.2.4.2	Room temperature controller	111
4.2.4.2.1	Operating modes and operating mode change-over	111
4.2.4.2.2	Control algorithms and calculation of command values	115
4.2.4.2.3	Adapting the control algorithms	123

4.2.4.2.4	Operating mode switchover	126
4.2.4.2.5	Temperature setpoints	136
4.2.4.2.6	Room temperature measurement	152
4.2.4.2.7	Command value and status output	155
4.2.4.2.8	Disable functions of the room temperature controller	162
4.2.4.2.9	Heating timer	163
4.2.4.2.10	Valve protection	165
4.2.4.3	Room temperature controller extension	166
4.2.4.3.1	Connection to room temperature controller	166
4.2.4.3.2	Operating functions	171
4.2.4.3.3	Display functions	174
4.2.4.3.4	Room temperature measurement	176
4.2.4.3.5	Behaviour after a device restart	177
4.2.4.4	Light scene function	178
4.2.4.5	Display	181
4.2.4.5.1	Display structure and information displayed	181
4.2.4.5.2	Symbols	188
4.2.4.5.3	Push button assistance function	189
4.2.4.5.4	Fault message and alarm texts	190
4.2.4.5.5	Manual fan control and fan level display	192
4.2.4.5.6	Display illumination	197
4.2.4.6	Delivery state	198
4.2.5	Parameters	199
4.2.5.1	General parameters	199
4.2.5.2	Parameters on the push button sensor function section	202
4.2.5.3	Parameter for the controller function section	239
4.2.5.4	Parameter on scene function	268
4.2.5.5	Parameters for the display	271
5	Appendix	279
5.1	Index	279

1 Product definition

1.1 Product catalogue

Product name: Push button sensor 3 Plus 2-gang / Push button sensor 3 Plus 5-gang (2+3)

Use: Sensor

Design: UP (concealed)

Order No. 5142 00 / 5145 00

1.2 Function

The push button sensor 3 plus combines the functions of a KNX/EIB single-room temperature controller, a push button sensor and a display unit in just one bus subscriber. The combination of these functions makes it possible, for example, to control the light, the blinds, and the room temperature centrally from the entry area of a room. The room temperature controller and push button sensor functions are each independent function sections of the device with their own parameter blocks in the ETS.

Depending on the device variant, the device has up to 5 control surfaces that can be used to operate the integrated room temperature controller and the push button sensor. The functions can be configured in the ETS. In addition the push button sensor 3 plus has 2 display buttons, which can be used to check the setpoint temperature of the room temperature controller and to configure additional device settings.

Push button functionality:

When a rocker or button is pressed, the device transmits telegrams to the KNX/EIB, depending on the ETS parameter settings. These can be, for instance, telegrams for switching or push button control, for dimming or for controlling blinds. It is also possible to program value transmitter functions, such as dimming value transmitters, light scene extensions, temperature value transmitters or brightness value transmitters.

In connection with a room temperature controller equipped with a 1-byte object for switchover of operating modes, the device can be used as a full-featured controller extension. The device can also be used for presence detection or for setpoint shifting purposes and to indicate different controller states. As a supplement to the controller extension the push button sensor has an integrated temperature sensor that makes it possible to measure and forward the local room temperature.

The operation concept of an operating area can be configured in the ETS either as a rocker function or alternatively as a push button function. With the rocker function, one operating area is divided into two actuation pressure points (left / right) with the same basic function. With the push button function a control surface is either divided into 2 adjacent, functionally-separate actuation pressure points (2 buttons). Alternatively a control surface can be evaluated as single-area operation (only a single large button). If a control surface is used as a single rocker function, then it is also possible to trigger special functions using full-surface operation.

The push button sensor 3 plus has two status LEDs per operating area. These status LEDs can either be switched on or off permanently, or can function as a status indicator for a button or rocker. As an alternative, the LEDs can also be activated via separate communication objects. The LEDs can either indicate the switching status of an object statically or by flashing, signal operating states of room temperature controllers, or indicate results of logical value comparison operations.

The colour of the status LEDs (red, green, blue) can be configured in the ETS either globally or separately, as required. Optionally a superposed function can be activated via the bus, in which the colour and display information of individual status LEDs can be changed according to priority.

Room temperature controller functionality:

The device can be used for single-room temperature control. Depending on the operating mode, the current temperature set value and on the room temperature, a variable for heating or cooling

control can be sent to the KNX/EIB for up to 2 control circuits. The controller distinguishes between different operating modes (comfort, standby, night, frost/heat protection) each with their own temperature setpoints for heating or cooling.

Moreover, when configuring only one control circuit it is possible to use an additional heating or cooling unit by activating an additional heater and/or cooling unit in addition to the heating or cooling basic level. In this connection, you can set the temperature setpoint difference between the basic and the additional level by a parameter in the ETS. For major deviations between the temperature set value and the actual temperature, you can activate this additional stage to heat up or cool down the room faster.

You can assign different control algorithms to the two control circuits and to the basic and additional levels. For heating and cooling functions, you can select continuous or switching PI or switching 2-point feedback control algorithms.

The room temperature can be recorded either by the internal or by an external temperature sensor, or also separately for the two control circuits. The external temperature sensor is connected to the bus coupling unit of the push button sensor 3 plus as a wired remote sensor. In addition, a KNX/EIB communication object is available that can be used to integrate into the temperature detection a temperature value received externally from the bus, e.g. from a controller extension. Combined temperature recording by two of the available sensors is also possible.

Optionally, the heating timer integrated into the device allows requirements-oriented switchover of the controller operating mode depending on the time of day and the day of the week. For this purpose, the device provides up to 28 separate switching times that can be preconfigured individually in the ETS, and can be modified subsequently via the settings menu while the push button sensor is in operation.

Display functionality:

The device's graphics display has 103 x 40 pixels and is equipped with switchable LED backlighting. The display is subdivided into various display areas, depending on the configuration in the ETS, the operating state and the specific device functions that are activated. A general distinction can be made between 1-area and 2-area display. With two display areas, the upper area of the normal display, also called the status line, shows symbols that indicate various operating modes of the room temperature controller or the controller extension.

Moreover it is optionally possible to display in the status line the time (left justified) and additional temperature values of the controller extension (right-justified).

The lower area of the display, also called the menu area, can be used to visualise various temperature values in a single-line or two-line format. In addition it is possible to display values that have been received by KNX/EIB via separate communication objects in various data and depiction formats. Furthermore, display of the time and date from an external KNX/EIB system clock in the graphics display can optionally be configured.

When only one display area is used, the simplest depiction option in the normal display is to show temperature values and to indicate the operating mode of the room temperature controller.

Each item of display information in the menu area can be supplemented with additional texts that are freely definable in the ETS. The menu area of the display can optionally be used to show alarm texts and comment text up to 14 characters long in a two-line format. These text displays override all normal displays in this area, and thus can provide direct information about various system states, for example the states of KNX/EIB alarm centres or facility systems.

The button help function can be enabled in the ETS especially for device control surfaces that are not labelled. The button help shows a one-line help text on the display for a certain duration that explains the function of the pressed button or rocker switch. The button help texts can be configured in the ETS for each button of the device.

General:

The labelling field of the push button can be illuminated. If no or a wrong application has been loaded into the push button sensor with the ETS, the labelling panel illumination and the backillumination of the display flashes with a frequency of approx. 0.75 Hz to indicate an error, and in this case the push button sensor does not work.

Alternatively, communication object control can be used to change the brightness of all status LEDs, the labelling field illumination and the backlighting of the display. This makes it possible,

for example, to reduce the brightness during nighttime hours to a value configured in the ETS. The device's programming mode is indicated by a separate programming LED, which is located on the front below the decorative covers directly adjacent to the programming button. In this manner the device can be commissioned easily with the ETS even in the installed state. Project planning and commissioning of the device is performed using the ETS 3.0d with Patch A or newer versions.

The push button sensor 3 plus must be plugged onto the flush-mounted bus coupling unit 3 (see Accessories). Only the combination of this bus coupling unit and the push button sensor cover results in a functional unit. Plugging the push button sensor onto a flush-mounted bus coupling unit 1 or 2 (older generation) is not intended, and as a result the device combination will not function.

It is also possible to use separate bus telegrams to disable the device or individual buttons, or to display an alarm.

Integrated into the push button sensor 3 plus is a scene module that can be used to control illumination and shading systems or various other facilities as needed by pressing just a single button. KNX / EIB actuators can be controlled in up to 8 scenes via up to 8 outputs by means of switching or value commands.

1.3 Accessories

Bus coupler 3	Order No. 2008 00
Bus coupler 3 external sensor	Order No. 2009 00
Second support ring	Order No. 1127 00
Remote sensor	Order No. 1493 00
Inscription sheet	Order No. 1090 00
Inscription sheet	Order No. 1089 00
Rocker set 2-gang plus	Order No. 2142 ..
Rocker set 5-gang plus	Order No. 2145 ..

2 Installation, electrical connection and operation

2.1 Safety instructions

Electrical equipment may only be installed and fitted by electrically skilled persons. The applicable accident prevention regulations must be observed.

Failure to observe the instructions may cause damage to the device and result in fire and other hazards.

Make sure during the installation that there is always sufficient insulation between the mains voltage and the bus. A minimum distance of at least 4 mm must be maintained between bus conductors and mains voltage cores.

The device may not be opened or operated outside the technical specifications.

2.2 Device components

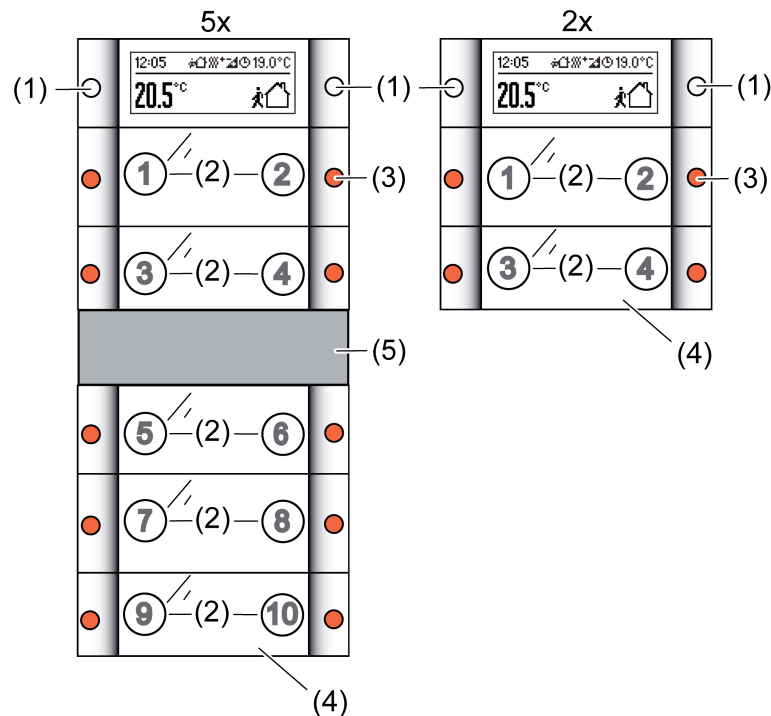

Figure 1: Device components of push button sensor 3 plus

- (1) Display control surface
(Graphics display and 2 x buttons left and right)
- (2) Control surfaces
(1 x rocker switch or 2 x button left and right / colours depend on design)
- (3) Status LED
(2 x per control surface left and right / colour configurable)
- (4) Labelling field with backillumination
- (5) Central web (colours depend on design)

Dimensions (2-gang):

Width (W): 55 mm / Height (H): 55 mm / Depth (D): 10 mm

Dimensions (5-gang):

Width (W): 55 mm / Height (H): 126 mm / Depth (D): 10 mm

i Specifications without flush-mounted bus coupling unit, without fastening brackets and without design frame.

i Neutral inscription panels are included with the devices as part of the scope of supply. If necessary, individual labels can be created using optionally available labelling sheets (see Accessories) and labelling software, or on the Internet at marking.gira.com.

2.3 Fitting and electrical connection

Fitting and connecting the device for device variant 2gang (single height)

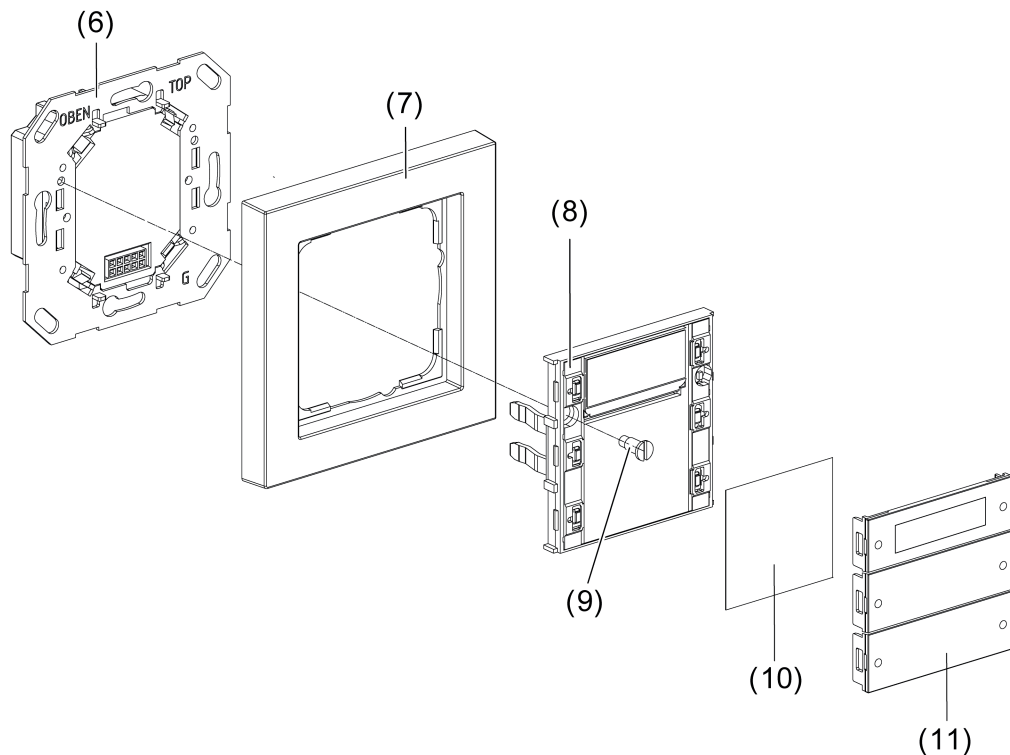

Figure 2: Device fitting of a push button 3 plus 2gang

- (6) Flush-mounted bus coupling unit 3 with supporting frame
- (7) Design frame
- (8) Push button sensor cover
- (9) Fit bolts for anti-theft protection (included with the push button sensor cover)
- (10) Inscription panel
- (11) Rocker cover

The push button sensor cover must be plugged onto a flush-mounted bus coupling unit 3. Anti-dismantling protection is provided by screwing to the supporting frame of the bus coupling unit.

- Connect the bus coupling unit (6) with the KNX/EIB bus cable.
- Optional: When using an external temperature sensor, connect the wire temperature/remote sensor to the 2pole screw terminal on the rear of the bus coupling unit. Do this by using a bus coupling unit 3 with a connection for an external sensor (see Accessories).
- Fasten the bus coupling unit 3 in place in an appliance box.
- Remove the rocker covers (11) and inscription panels (10) from the push button sensor cover (8).
- Position the design frame (7) in front of the bus coupling unit and carefully plug the push button sensor cover into the bus coupling unit.
- Screw the push button sensor cover to the supporting frame of the bus coupling unit. Use the screw (9) provided.

- If necessary, label the inscription signs. Optionally the separately available labelling sheets (see Accessories) can be used.
 - Finally, mount the rocker covers together with the labelling panel by snapping them on.
- i** Before final fitting of the rocker covers, the physical address has to be loaded into the device (see page 14).

Fitting and connecting the device for device variant 5gang (doubled height)

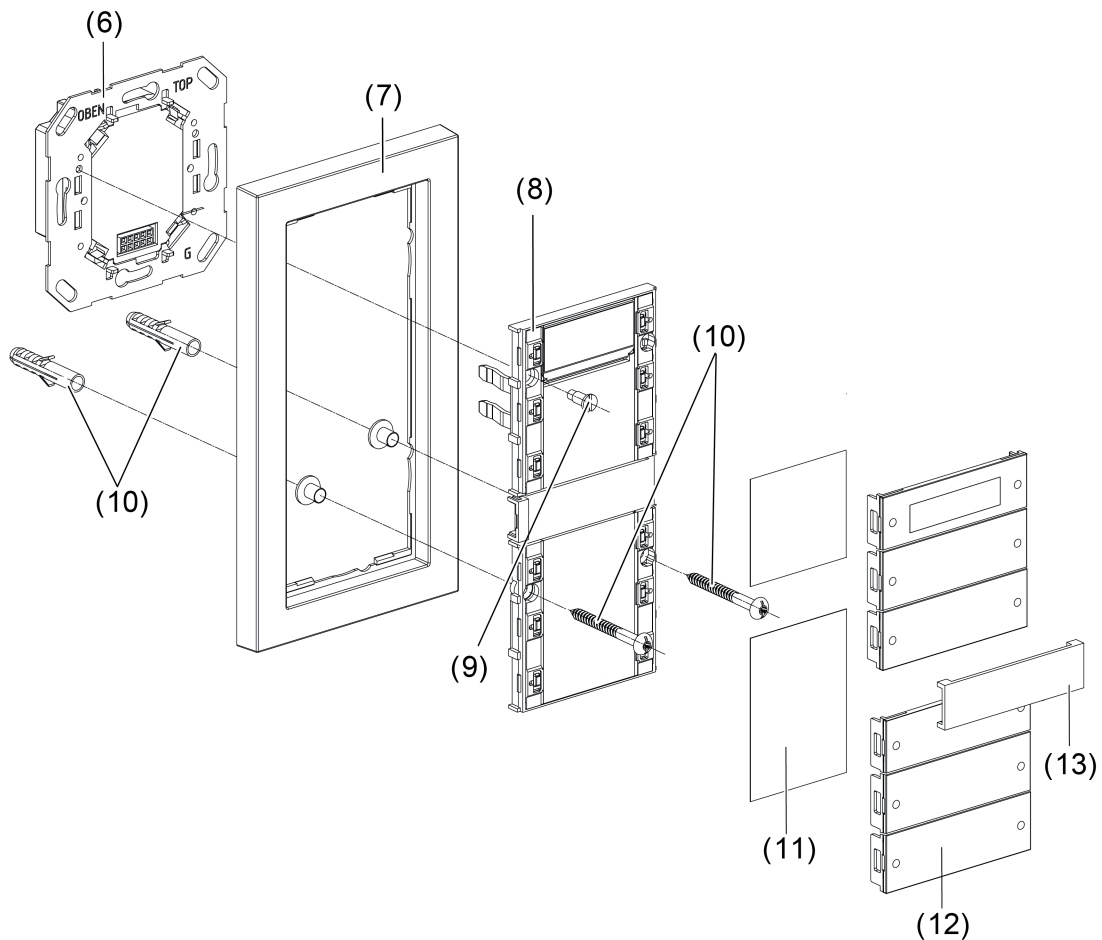

Figure 3: Device fitting of a push button 3 plus 6gang (doubled height)

- (6) Flush-mounted bus coupling unit 3 with supporting frame
- (7) Design frame
- (8) Push button sensor cover
- (9) Fit bolts for anti-theft protection (included with the push button sensor cover)
- (10) Screw and anchor set for mechanical fastening and for anti-theft protection (included with the push button sensor cover)
- (11) Inscription panel
- (12) Rocker cover
- (13) Central web

The push button sensor cover must be plugged onto a flush-mounted bus coupling unit 3. Anti-dismantling protection is provided by screwing to the supporting frame of the bus coupling unit. In addition, the lower part of the push button sensor cover is screwed to the wall, or in the case of mounting on 2 appliance boxes, to a second supporting frame. Mounting requires a design frame 2gang without central web.

- Connect the bus coupling unit (6) with the KNX/EIB bus cable.
- Optional: When using an external temperature sensor, connect the wire temperature/remote sensor to the 2pole screw terminal on the rear of the bus coupling unit. Do this by using a bus coupling unit 3 with a connection for an external sensor (see Accessories).
- Fasten the bus coupling unit 3 in place in an appliance box.
- Remove the rocker covers (12) and inscription panels (11) from the push button sensor cover (8).

For mounting on only one appliance box, the lower part of the push button sensor cover is screwed to the wall with the aid of the supplied screw and anchor set (10). To do this, proceed as follows:

- Position the design frame 2gang without central web (7) in front of the bus coupling unit and carefully plug the push button sensor cover into the bus coupling unit.
 - Mark the drill hole positions on the wall. Do this by using the push button sensor cover as a template.
 - Pull the push button sensor off of the flush-mounted bus coupling unit again. Drill holes (Ø 5mm) and insert the anchors.
- i** The use of the anchors depends on the properties of the surface.
- Position the design frame 2gang without central web in front of the bus coupling unit and carefully plug the push button sensor cover into the bus coupling unit again.
 - Screw the push button sensor cover to the supporting frame of the bus coupling unit. Use the screw (9) provided.
 - In addition, fasten the lower part of the push button sensor cover in the predrilled holes with the aid of the wall screws (10).
 - If necessary, label the inscription signs. Optionally the separately available labelling sheets (see Accessories) can be used.
 - Finally, mount the rocker covers together with the labelling panel by snapping them on.

For mounting on two appliance boxes, the lower part of the push button sensor cover is screwed to a second supporting frame (see Accessories). To do this, proceed as follows:

- Mount the second supporting frame on the lower appliance box.
- Position the design frame 2gang without central web (7) in front of the bus coupling unit and the second supporting frame and carefully plug the push button sensor cover into the bus coupling unit.
- Screw the push button sensor cover to the supporting frame of the bus coupling unit. Use the screw (9) provided.
- Screw the lower part of the push button sensor cover to the second supporting frame. Do this using the screws included in the scope of supply of the supporting frame.
- If necessary, label the inscription signs. Optionally the separately available labelling sheets (see Accessories) can be used.
- Finally, mount the rocker covers, the central web (13) together with the labelling panel by snapping them on.

- i** Before final fitting of the rocker covers, the physical address has to be loaded into the device (see page 14).

2.4 Commissioning

Loading the physical address and application software

The commissioning of the device is basically confined to programming of the physical address and the application data with the ETS.

Project planning and commissioning of the device using the ETS 3.0d with Patch A or newer versions.

The device is connected and ready for operation.

An appropriate device must be created and configured in the ETS project.

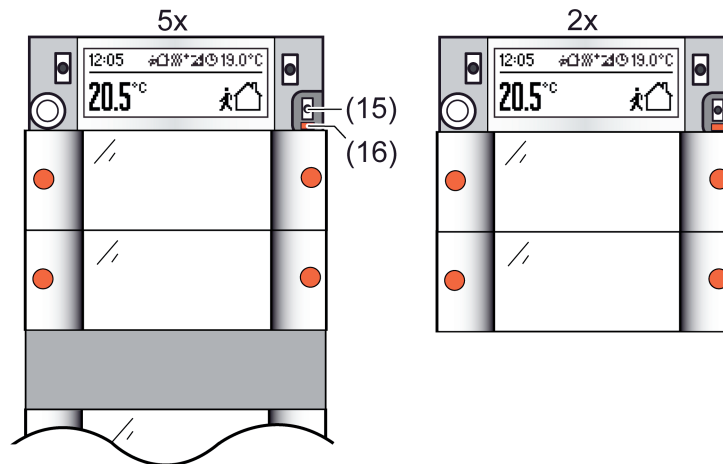

Figure 4: Arrangement of the programming button and LED on the front of the device

The programming button is located on the front of the device behind a labelling panel (Figure 4). Before final fitting of the rocker covers, the physical address has to be loaded into the device.

- Detach the control surface over the programming button/LED, if the rocker covers are already fitted.
- Activating Programming mode: press the programming button (15).
The programming LED (16) lights up red.
- Program the physical address with the help of the ETS.
The programming LED goes out.
- Load the application data into the device using the ETS.
- Mount control surface(s).

i If the device was programmed with incorrect application data, then backillumination of the labelling field flashes slowly. In this case, the device will not function after start-up.

2.5 Operation

Depending on the device variant, the device consists of up to 6 mechanically separate control surfaces. The control surfaces are the design covers attached to the device with push button elements underneath. A distinction is made between the display control surface (1) and the control surfaces of the push button sensor function (2) (Figure 5).

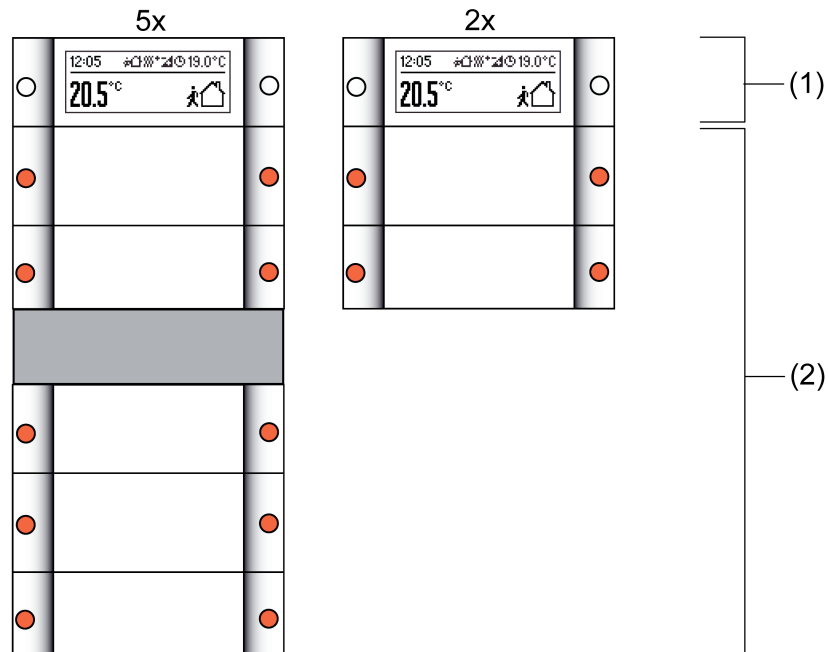

Figure 5: Arrangement of the control surfaces on the front of the device

- (1) Display control surface
Function: controller operation (setpoint shift) and menu operation
- (2) Push button sensor control surfaces incl. status LEDs.
Function: Any desired push button sensor function or controller operation

The central part of the upper display control surface is transparent, and surrounds the LC display. This control surface has two actuation pressure points on the left and right. The display control surface can be used to preset settings for the room temperature controller (setpoint shift) (see page 18-19). Furthermore, the display buttons can be used to make device settings (see page 20).

The lower control surfaces are allocated to the push button sensor function. The function of these rockers can also be configured in the ETS to any desired push button sensor function. Alternatively it is possible to set operation of the integrated room temperature controller or of the controller extension. The push button sensor function is an independent function section of the device with its own parameter blocks in the ETS. Insofar as the control surfaces are to operate the integrated room temperature controller, the following functions can be parameterised in the push button configuration: setpoint shift, presence button, operating mode change-over. What is more, a button-press can be used to activate or deactivate the integrated heating timer, and the fan level can be changed over manually on a KNX/EIN fan coil actuator. For a detailed description of all operating functions, please see Chapter 4. of this documentation (see page 80).

The operation concept of an operating area of the push button sensor function (2) can be configured in the ETS either as a rocker function or alternatively as a push button function. With the rocker function, one control surface is divided into two actuation pressure points with the same basic function. In the push button function either a control surface is divided into 2 functionally separate actuation pressure points (2 buttons), or a control surface is evaluated as

single-surface operation (only one large button).

If a control surface is used as a single rocker function, then it is also possible to trigger special functions using full-surface operation.

The push button sensor 3 plus has two status LEDs per operating area. These status LEDs can either be switched on or off permanently, or can function as a status indicator for a button or rocker. As an alternative, the LEDs can also be activated via separate communication objects. The LEDs can either indicate the switching status of an object statically or by flashing, signal operating states of room temperature controllers, or indicate results of logical value comparison operations.

The colour of the status LEDs (red, green, blue) can be configured in the ETS either globally or separately, as required. Optionally a superposed function can be activated via the bus, in which the colour and display information of individual status LEDs can be changed according to priority.

The labelling field of the push button sensor can signal the switching state of its own object, flash or be permanently on or off, or can serve as an orientation light if necessary. If no application has been loaded into the push button sensor with the ETS, the illumination flashes with a frequency of approx. 0.75 Hz to indicate an error.

2.5.1 Basic display

The device's graphics display has 103 x 40 pixels and is equipped with switchable LED backlighting. The display is subdivided into various display areas, depending on the configuration in the ETS, the operating state and the specific device functions that are activated. A general distinction can be made between 1-area and 2-area display. With two display areas (Figure 6), the upper area of the normal display, also called the status line, shows symbols that indicate various operating modes of the room temperature controller or the controller extension. Moreover it is optionally possible to display in the status line the time (left justified) and additional temperature values of the controller extension (right-justified).

The lower area of the display, also called the menu area, can be used to visualise various temperature values in a one-line or two-line format. In addition it is possible to display values that have been received by KNX/EIB via separate communication objects in various data and depiction formats. Furthermore, display of the time and date from an external KNX/EIB system clock in the graphics display can optionally be configured.

When only one display area is used (Figure 7), the normal display shows temperature values and indicates the operating mode of the room temperature controller. This type of display is the clearest and simplest display function.

The form of the display areas and thus the selection of information shown on the display depends on the parameter configuration in the ETS. For further information on the display options in the basic display and about the display configuration, see the chapter "Display" in this documentation (see page 181).

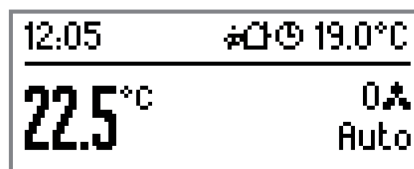

Figure 6: Example of a basic display with two display areas (Time, setpoint temperature, room temperature, fan level display)



Figure 7: Example of a basic display with one display area
(Room temperature, operating mode display)

2.5.2 Menu "Setpoint"

The two display buttons of the device can be used to shift the setpoint temperature of the room temperature controller. The temperature can be shifted in the positive or negative direction within a specified range. The setpoint can be shifted using the display buttons both on a main controller or also on controller extensions.

The setpoint shift is called up if the normal display is active and the left or right display button is pressed once. After that the menu "Setpoint" is displayed (Figure 8). The selection can be confirmed by pressing the the right-hand display button ✓. Pressing the left-hand display button x aborts the setpoint shift. The display then returns to the normal display.

If the selection is confirmed, the display then shows the setpoint temperature of the active operating mode of the room temperature controller. Depending on the parameter setting in the ETS (see page 182), either an absolute temperature value is displayed, or the value of the basic setpoint shift relatively as a bar graph.

By pressing the right + or left - button it is possible to shift the setpoint temperature within the specified limits. With Version 1.2 applications, the step width of the shift in the ETS can be configured using the parameter "Step width of the setpoint shift" in the parameter node "Room temperature control (RTR) -> Controller general -> Setpoints" (0.1 K / 0.5 K / 1.0 K). In Version 1.1 applications, the step width is permanently defined as 0.1 K.

The application of the set setpoint shift into the controller is dependent on the application version. With the Version 1.2 application program, the behaviour in the ETS can be configured...

- Confirm the setpoint in the display using OK:
If the ETS parameter "Confirm setpoint in the display with OK?" in the "Display" parameter node is set to "Yes" (standard setting), then an OK command is required for valid application of the set setpoint shift. Pressing both display buttons simultaneously triggers the OK command. The controller then applies the setpoint shift immediately. The display then returns to the normal display.
- Apply setpoint immediately:
If the ETS parameter "Confirm setpoint in the display with OK?" is configured to "No", then the controller applies the set setpoint shift automatically, each time the + or - button is pressed. The display returns to the normal display when any button of the rockers 1...n is pressed or no entry is made via the display buttons for 15 seconds.

With the Version 1.1 application program, the behaviour is permanently defined. Here, for valid application of the set setpoint shift, an OK command through simultaneous pressing of both display buttons is required.

- i** The function of the Version 1.2 application to apply a setpoint shift without an OK is only possible on devices with release code I05 or higher. On older devices with earlier release codes, application is only ever possible with OK, no matter how the parameter for setpoint confirmation is set.

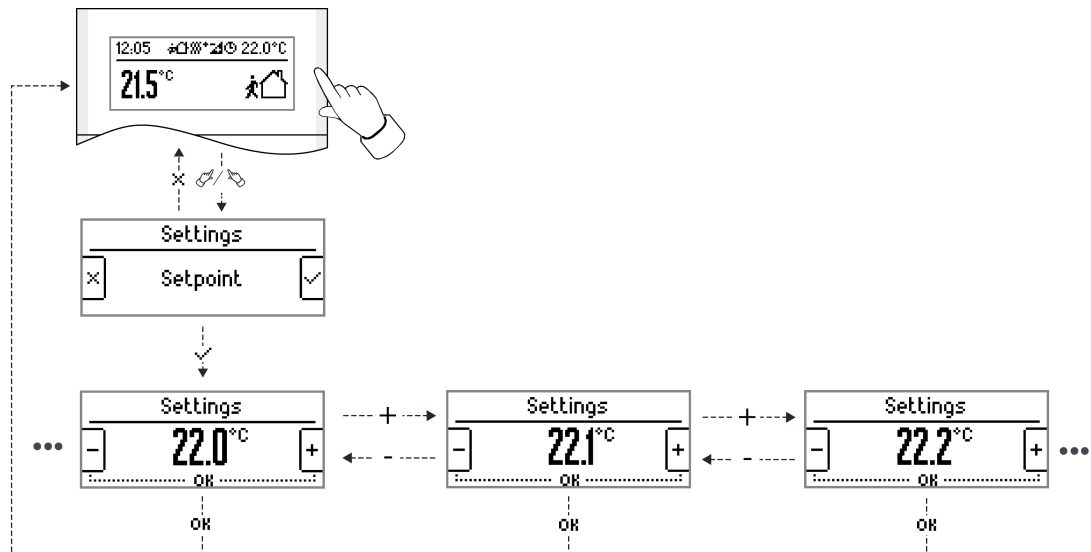

Figure 8: Menu operation for setpoint shift, using the example of the application of the setpoint shift through "OK"
Representation with absolute temperature value (not as bar graph)

For a setpoint shift a distinction is made whether the setpoint presetting is relative or absolute (see page 136).

The basic setpoint shift (temperature offset offset of the basic temperature with relative setpoint presetting) can be set in every mode and optionally accepted in case of an operating mode switch-over (e.g. comfort mode -> standby mode), so that the shift takes effect in all operating modes of the controller. Alternatively the basic setpoint shift is reset in the event of a operating mode switch-over.

With absolute setpoint presetting the setpoint shift directly affects the object "Setpoint active operating mode" and thus directly only the specified setpoint temperature of the specific active operating mode. The last setpoint temperature specified via the bus or by the ETS is first overwritten by a shift. Depending on the ETS parameterisation, the controller saves the shifted temperature value either in non-volatile memory (EEPROM), or only temporarily.

For more information about specification or shifting of setpoint temperatures with relative or absolute setpoint presetting, see chapter 4. "Room temperature controller".

- i** In case of two control circuits (also with separate setpoints), the set-temperatures of both circuits will be shifted.
- i** A setpoint shift does not affect the temperature setpoints for the frost or heat protection.
- i** The setpoint cannot be shifted using the display buttons if controller operation is currently disabled.
- i** With relative setpoint presetting a basic setpoint shift can optionally also be performed using a communication object via the bus (e.g. using controller extensions). Furthermore, with relative or absolute setpoint presetting setpoint temperatures can be specified via the bus and thus changed. If a new shift or new setpoints are received via the bus and at the same time the menu "Setpoint" is active, then the display shows the message **"The setting has been discarded"**. After that the menu is automatically exited. In this case the settings configured via the menu are discarded!

2.5.3 Menu "Settings"

Main menu

Without using the ETS, the two display buttons of the device can be used to perform various device settings and also to execute operating functions. For example, it is possible to configure the room temperature controller (operating mode switchover, setting the setpoint temperatures) and to set the heating timer and the display contrast. Furthermore, if a fan controller is present the fan levels can be set manually.

In order to avoid the unintentional disruption of essential functions of the device, access to individual settings can be prevented via the parameterisation in the ETS. When the button disabling function is active, access to the settings is completely blocked.

The settings can be changed using the display buttons both on a main controller or also on controller extensions. The setting options on the controller extensions are limited, however.

The configuration menu is called up if the normal display is active and at the same time the left and right mouse buttons are pressed. After that the menu "Settings" is displayed (Figure 9). The selection can be confirmed by pressing the the right-hand display button ✓. Pressing the left-hand display button x aborts the configuration menu. The display then returns to the normal display.

If the selection is confirmed, the display then shows the main menu. Depending on the enabling settings in the ETS, various menu entries are shown, which can be selected using the buttons ▲ and ▼.

A selected menu entry can be opened by pressing both of the **OK** display buttons. The display then goes to the corresponding submenu.

The main menu can be exited by selecting and confirming the entry "Abort". Alternatively the main menu will be exited if no further input is made for approx. 15 seconds.

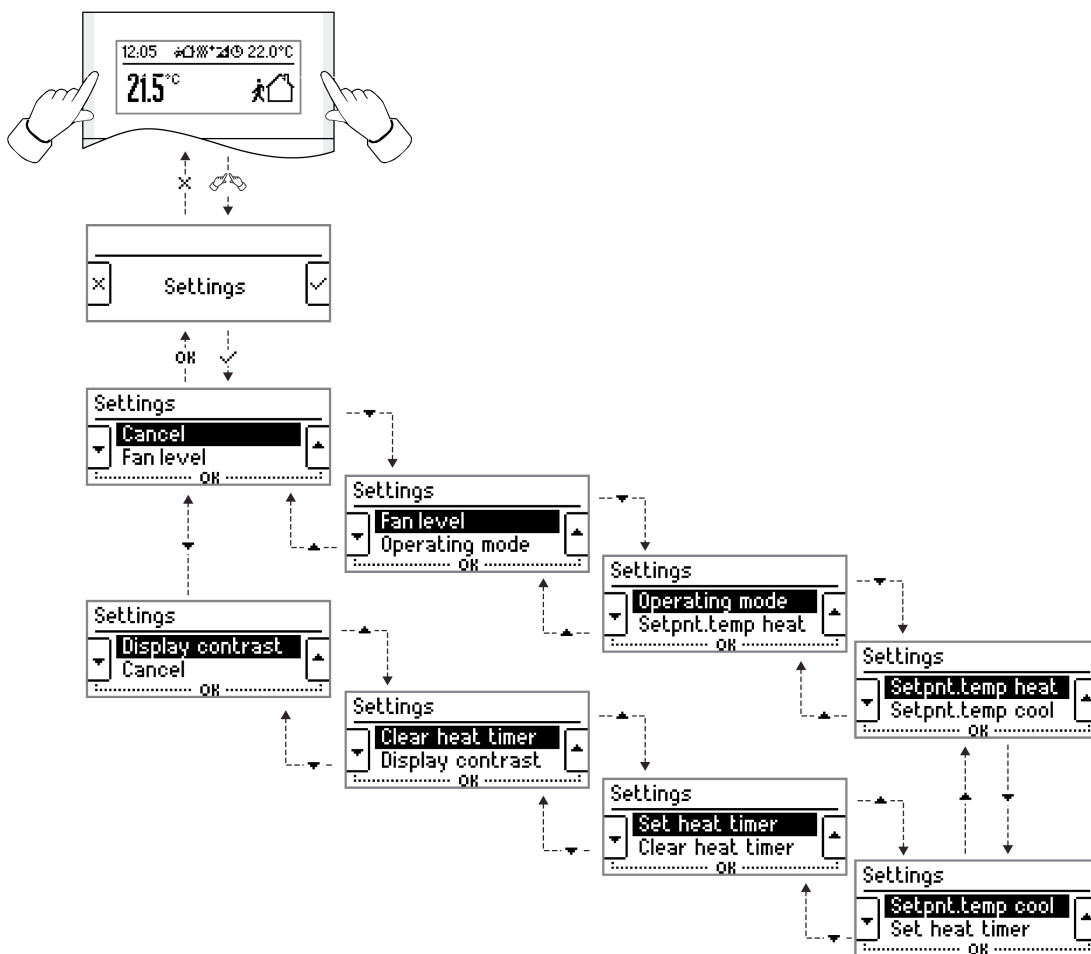

Figure 9: Navigation through the main menu of the device settings

Depending on fundamental device configurations in the ETS and also on enabling parameters, individual menu entries may be invisible and thus also not capable of being changed. The menu entry "Fan level" is only visible if manual fan control is enabled in the ETS (see page 192). If a fan controller is present the fan levels can be set manually by selecting this menu item (fan coil unit).

The entry "Operating mode" is visible in a main controller and also in controller extensions. The operating mode of the room temperature controller can be switched over by selecting this menu item.

The menu entries "Setpnt.temp heat" and "Setpnt.temp cool" can be used to set the setpoint temperatures of the various controller operating modes. The respective setpoint temperatures for heating and cooling can only be changed if the controller is configured to the corresponding operating modes, the setpoint presetting is relative (temperatures derived from basic setpoint) and changing has been enabled in the ETS for individual temperature values. These menu entries are hidden in controller extensions.

The entries "Set heat.tim" and "Del heat.tim" make it possible to change and configure switching times of the integrated heating timer (see page 163-164). As a result, these entries are only visible if the heating timer is also enabled in the ETS. These menu entries are always hidden in controller extensions. Disabling the heating timer via the bus has no effect on the visibility of the heating timer submenu.

The menu item "Display contrast" is always visible. By selecting this menu item the contrast of the LC display can be changed, thus adapting it for the local lighting conditions.

When controller operation is disabled, the entries "Operating mode", "Setpnt.temp heat" and "Setpoint. temp cool" can be hidden temporarily. If controller operation is disabled via the bus while the configuration menu is still active on the device, then when disabled controller settings

are changed the push button sensor shows the text "**The setting has been discarded**", thus indicated that operation is no longer possible.

Fan controller

The menu "Fan controller" can be used to switch the fan level of a fan coil, if present, up or down in steps, if it controlled by a Gira KNX/EIB fan coil actuator (order no. 2163 00). In operation, a distinction is made between the automatic mode and the manual operation of the fan coil.

After the main menu entry "Fan controller" is confirmed with **OK**, the display goes to the corresponding submenu (Figure 10) and shows the automatic mode or the fan level of the fan coil.

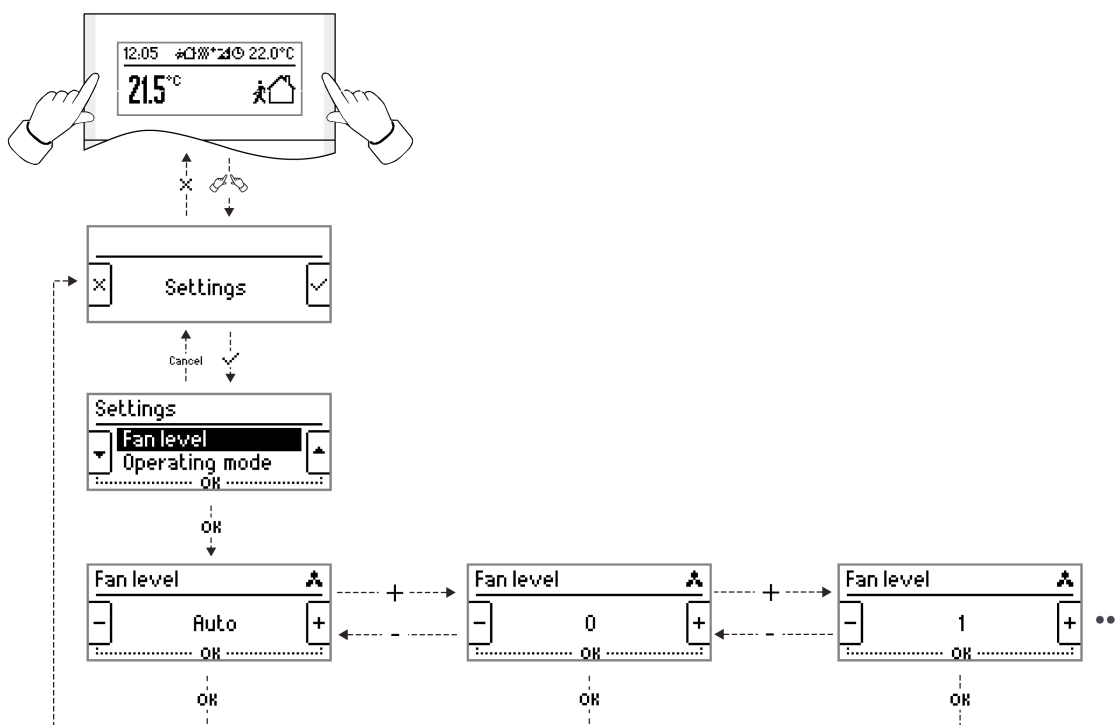

Figure 10: Example for the submenu of the manual fan control

With manual fan control a distinction is made whether automatic mode or manual operation of the fan coil is active when the menu is called up.

With activated automatic mode:

The display shows "**Auto**". Pressing the display button - or + first automatically activates manual operation. The automatic functions of the fan controller are then deactivated. The display shows the active fan level. It is now possible by pressing the right-hand display button + to switch the fan level up manually step by step until the maximum level is reached. Pressing the left-hand display button - switches the fan level down step by step to "0" (fan OFF). Pressing the left-hand display button - again in the "OFF" state deactivates the manual fan control and activates the automatic mode again. The display then shows "**Auto**".

When manual operation is activated:

The display shows the active fan level of the manual control. It is now possible by pressing the right-hand display button + to switch the fan level up manually step by step until the maximum level is reached. Pressing the left-hand display button - switches the fan level down step by step to "0" (fan OFF). Pressing the left-hand display button - again in the "OFF" state deactivates the manual fan control and activates the automatic mode. The display then shows "**Auto**".

- i** To control a fan coil, the push button sensor 3 plus must be connected with a Gira KNX/EIB fan coil actuator via various communication objects. It is also important to adapt the parameterisation of the fan coil actuator to the functions of the push button sensor. A more detailed description of the manual fan control and the necessary device configuration can be found in the chapter "Display" of this documentation (see page 192).
- i** Manual fan control is also possible via a rocker switch or push button function of the push button sensor function section.

Operating mode switchover

The menu "Operating mode" can be used to influence the setpoint temperature of the integrated or external room temperature controller. Individual setpoint temperatures are assigned to the 4 controller operating modes (Comfort, Standby, Night, Frost/heat protection). After the main menu entry "Operating mode" is confirmed with **OK**, the display goes to the corresponding submenu (Figure 11) and shows the currently active operating mode.

- i** The menu "Operating mode" is visible in a main controller and also in controller extensions.

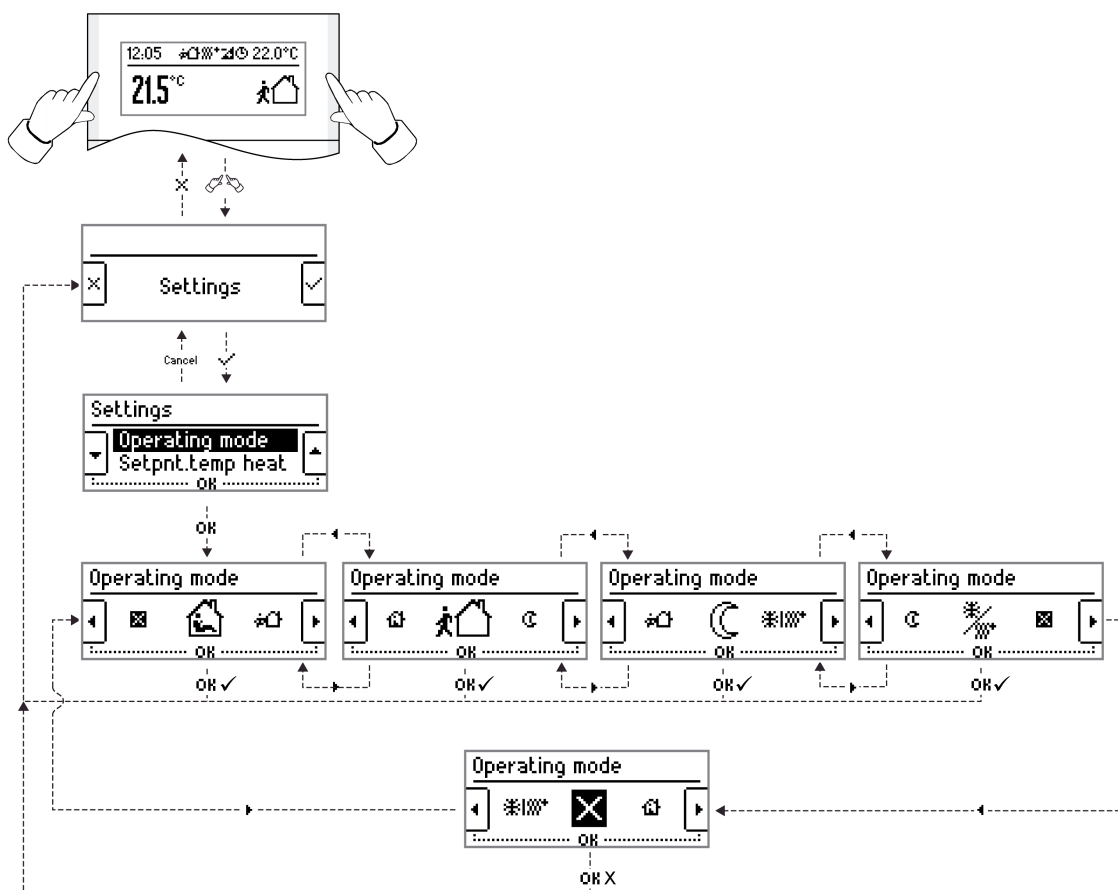

Figure 11: Example for the submenu of the operating mode switchover

In the submenu it is possible to select the desired operating mode by pressing the display buttons ◀ or ▶. After that, if both display buttons are pressed at the same time (**OK**), the push button sensor accepts the selection as a valid new setting and exits the submenu. The controller operating mode cannot be accepted (**OK** hidden) if the current controller operating mode has

been set by a function with higher priority (e.g. KNX forced object, window status, automatic frost protection).

If the menu entry **✘** is selected and confirmed with **OK**, the push button sensor exits the submenu without changing the operating mode.

- i** When controller operation is disabled, the menu "Operating mode" is not visible.
- i** The operating mode can optionally also be switched over using communication objects via the bus or via the automatic frost protection function. If an operating mode specification is received via the bus and at the same time the menu "Settings" or its submenus are active, then the display shows the message "**The setting has been discarded**". After that the last menu active is automatically exited. In this case the settings configured via the menu are discarded!

Setpoint temperature setting

The menus "Setpnt temp heat" and "Setpoint. temp cool" can be used to display and change the setpoint temperatures of the integrated room temperature controller directly. After confirmation of one of the main menu entries with **OK** the display goes to the corresponding submenu (Figure 12).

It should be noted that the visibility and editability of the menus for setting the setpoint temperature are dependent on the ETS settings. It is defined in the ETS whether changes of the setpoint for the basic temperature, changes in the setpoint temperatures for standby and night mode or the dead band shift (influence on the menu "Setpnt.temp cool") are possible. In addition, the respective setpoint temperatures for heating and cooling can only be changed if the controller is configured to the corresponding operating modes.

The controller allows the option of configuring the temperature setpoints as relative (derived from basic setpoint) or absolute (independent setpoint temperatures for each operating mode). With absolute setpoint presetting it is not possible to edit the setpoint temperatures in the menu for the settings.

If changes are not allowed or an operating mode is not configured, individual temperature values are not editable or a complete submenu is missing (e.g. "Setpnt.temp cool" is missing if the controller is only parameterised for "Heat"). When controller operation is disabled, the menus "Setpnt.temp heat" and "Setpoint. temp cool" are not visible.

- i** The menus "Setpnt temp heat" and "Setpoint. temp cool" are not visible on controller extensions.

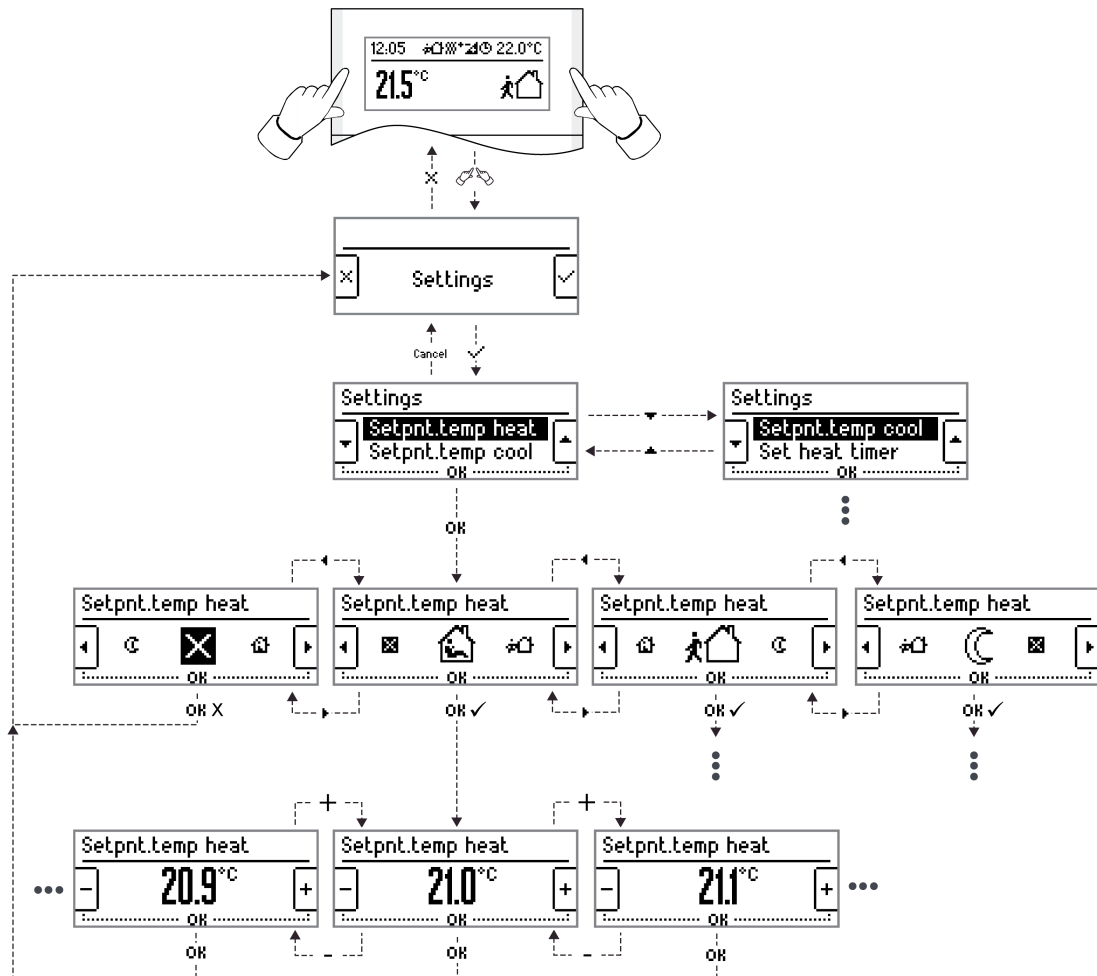

Figure 12: Example of the submenu for setting setpoints for heating mode (applies similarly to cooling mode)

In the submenu it is possible to select the desired operating mode whose setpoint temperature is to be edited by pressing the display buttons ◀ or ▶. The editing mode is called up by pressing both display buttons (OK) at the same time. The initial value of the setpoint temperature of the selected operating mode is shown on the display. Pressing the left - or right + display button adjusts the setpoint upwards or downwards. The step width of the temperature adjustment is aligned to the step width of the setpoint shift. This is dependent upon the application program used. In Version 1.2 applications, the step width can be configured in the ETS (0.1 K / 0.5 K / 1.0 K). In Version 1.1 applications, the step width is permanently defined as 0.1 K.

Pressing both display buttons (OK) again at the same time causes the push button sensor to accept the temperature as a valid new setpoint and to exit the submenu. The controller then switches to the operating mode whose setpoint temperature has been changed.

If in the operating mode selection the menu entry ✕ is selected and confirmed with OK, the push button sensor exits the submenu without calling up the editing mode. In this case the temperature setpoints and the operating mode remain unchanged.

- i** The frost/heat protection temperatures cannot be changed on the device. This can only be done via setpoint presetting in the ETS.
- i** With two control circuits with separate setpoints, the configuration menu can only be used to setpoint temperatures of the first control circuit.

- i** In two-level heating and/or cooling mode, the menu for the setpoints only shows the temperatures of the basic level(s).
- i** The temperature setpoints can optionally also be switched over using communication objects via the bus. If new setpoint specifications are received for the push button sensor via the bus and at the same time the menu "Settings" or its submenus are active, then the display shows the message "**The setting has been discarded**". After that the last menu active is automatically exited. In this case the settings configured via the menu are discarded!

Configuring heating timer

The heating timer integrated into the device allows requirements-oriented switchover of the controller operating mode depending on the time of day and the day of the week. For this purpose, the device provides up to 28 separate switching times that can be preconfigured individually in the ETS, and can be modified subsequently via the settings menu while the push button sensor is in operation.

The menu "Set heat.tim" (Figure 13) can be used to edit existing entries or to create new switching times, so long as there are free memory slots.

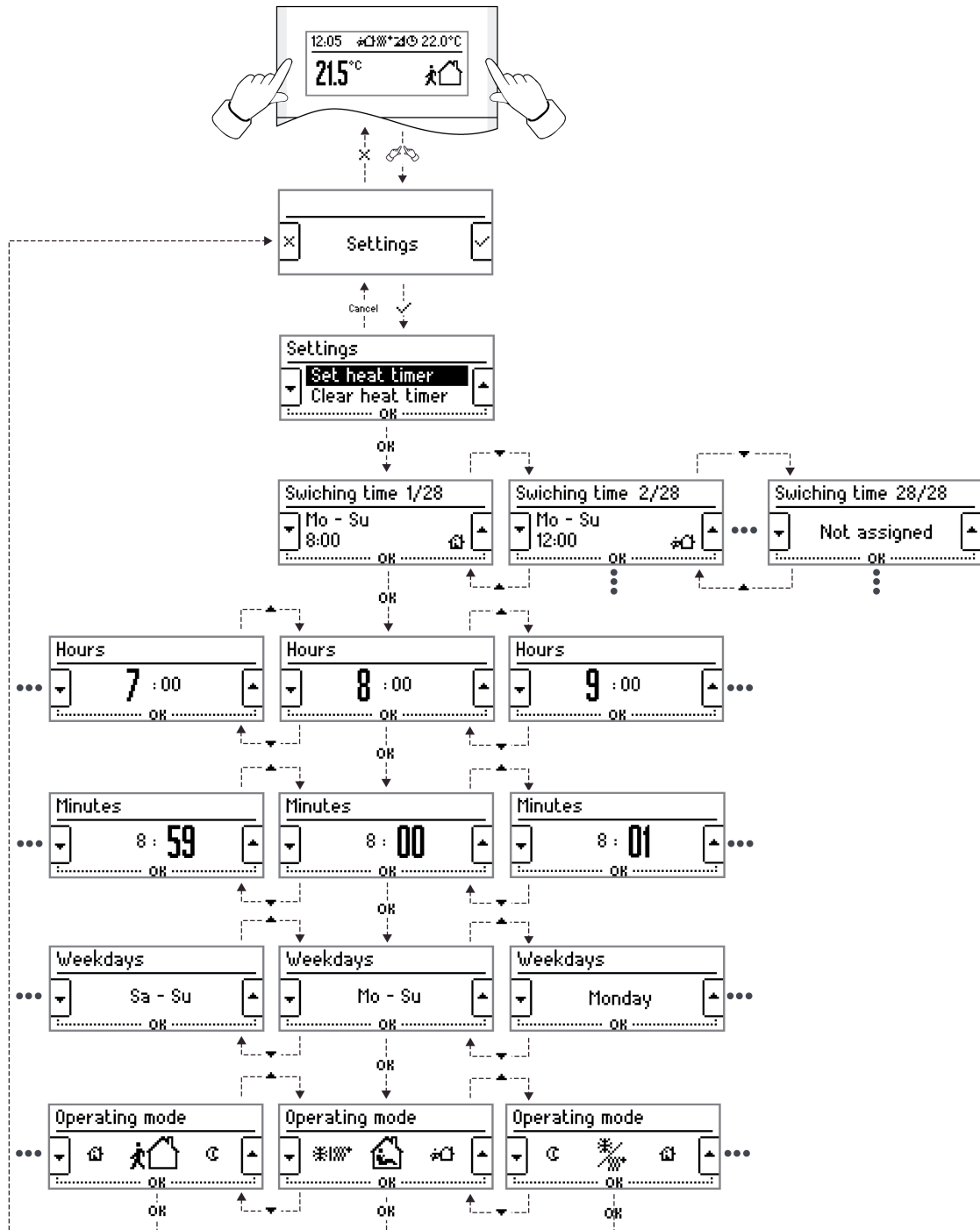

Figure 13: Example of the submenu for setting the heating timer

In the submenu "Set heat.tim" it is possible to select one of the 28 memory slots by pressing the display buttons ▲ or ▼. If the selected memory slot has been assigned with a switching time, the display shows the characteristics of the switching time (time, day(s) of the week, operating mode). If the selected memory slot has not been assigned with a switching time, **"not assigned"** is shown on the display.

The editing mode for a memory slot is called up by pressing both display buttons (OK) at the same time. In this manner it is possible to change existing switching times or create new ones. In the editing mode of a memory slot, pressing both of the display buttons (OK) alternately sets the following characteristics for the switching time: time in hours, time in minutes, day of the week, controller operating mode. In each of these steps it is possible to select the available

settings using the display buttons ▲ or ▼.

After the operating mode is set, pressing both of the display buttons (**OK**) causes the switching time to be accepted validly in the device memory. The push button sensor then exits the submenu.

- i** The push button sensor only executes the programmed switching times if the heating timer is active (the ☉ appears in the display). Activation or deactivation of the heating timer is possible via a push button function of the device or via the disabling function of the heating timer (see page 163-164).
- i** In some circumstances the switching times set in the submenu of the heating timer may deviate from the switching times originally defined in the ETS and programmed into the device during commissioning. In the ETS parameterisation it is possible to define whether or not the switching times of the heating timer present in the device should be overwritten by the switching times defined in the ETS during a programming operation. If the switching times present in the device are overwritten during a programming operation, then the switching times edited by the user in the configuration menu are discarded permanently!
- i** The push button sensor has an internal clock that has to be set regularly via the bus using a communication object. The internal clock controls the execution of the switching times of the heating timer.
The heating timer executes the switching times at the 00 second mark of each new minute. If a switching time is edited and accepted in the menu and its timestamp corresponds to the current time, then the push button sensor only executes the switching time on the next day, if the following day of the week is taken into account in the configuration.
Example 1:
Current time 8:30 a.m. -> A switching time is edited to 8:30 a.m. and accepted. -> The push button sensor executes the switching time only on the next day at the specified time, so long as the day of the week corresponds to the specifications.

When a time telegram is received via the bus the push button sensor evaluates its switching times again. If the new time deviates from the old one in hours or minutes, the heating timer executes switching times as long as the time corresponds to the current, newly specified time.

Example 2:

Current time 7:59 a.m. -> New time telegram 8:00 a.m. -> A switching time is defined for 8:00 a.m. The push button sensor executes the switching time immediately after the new time specification.

Example 3:

Current time 8:01 a.m. -> New time telegram 8:00 a.m. -> A switching time is defined for 8:00 a.m. The push button sensor executes the switching time immediately after the new time specification.

If the new time in minutes and hours is the same as the old one, the push button sensor does not execute any switching times, because the switching time has already been executed before the time specification and the time deviation is less than 60 seconds.

Example 4:

Current time 8:00 a.m. -> New time telegram 8:00 a.m. -> No response when switching times are processed.

- i** It is possible to configure multiple switching times to the same time and to identical days of the week. In this case the push button sensor only executes the switching time with the highest switching time number.

The menu "Del heat.tim" (Figure 14) can be used to delete existing entries.

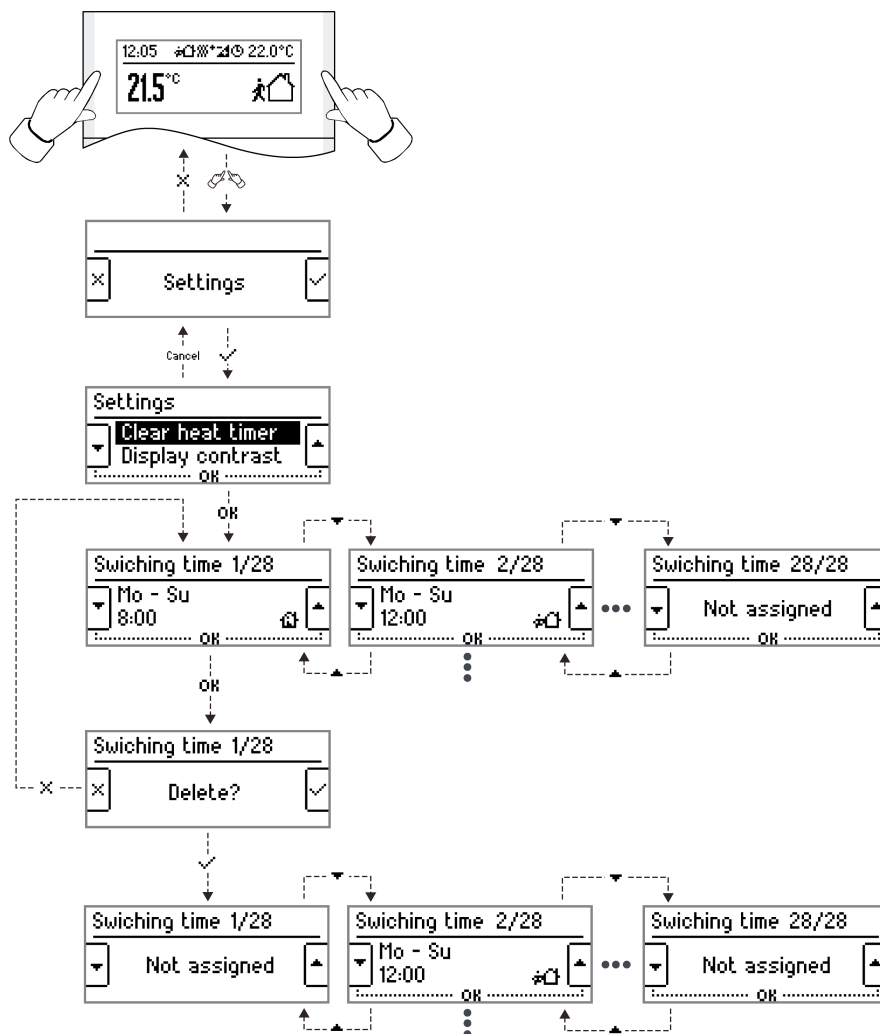

Figure 14: Example of the submenu for deleting the switching times of the heating timer

In the submenu "Del heat.tim" it is possible to select one of the 28 memory slots by pressing the display buttons ▲ or ▼. If the selected memory slot has been assigned with a switching time, the display shows the characteristics of the switching time (time, day(s) of the week, operating mode). If the selected memory slot has not been assigned with a switching time, "**not assigned**" is shown on the display.

The delete mode is called up by pressing both display buttons (OK) at the same time when a switching time is present. The display shows "**Delete?**". and expects that the operator will confirm the delete command using ✓. The delete mode can be aborted by pressing the left display button x. The push button sensor then retains the switching time without changes. The push button sensor deletes the switching time permanently when the delete command has been confirmed.

- i** The submenus of the heating time are only visible if the heating timer is also enabled in the ETS. Disabling the heating timer via the bus has no effect on the visibility of the heating timer submenu. The menus "Set heat tim" and "Del heat.tim" are not visible on controller extensions.

Set display contrast

The contrast of the LC display can be changed, thus adapting it for the local lighting conditions. After the main menu entry "Display contrast" is confirmed with **OK**, the display goes to the corresponding submenu (Figure 15) and shows the current contrast value.

i The menu entry "Display contrast" is always visible in the menu for the settings.

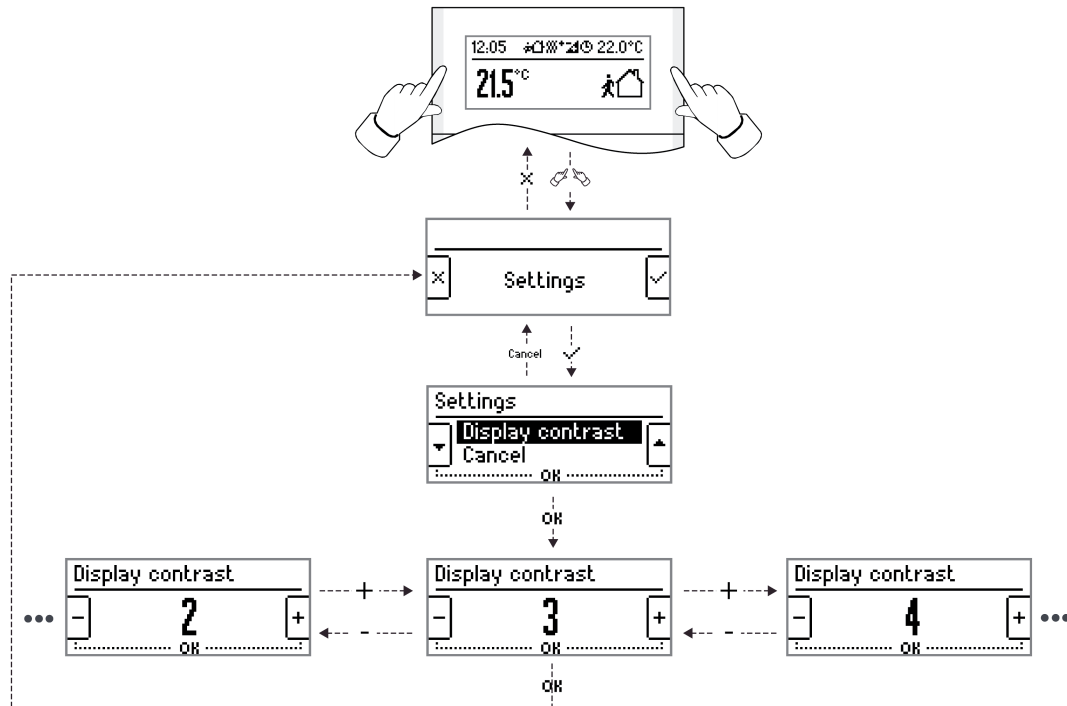

Figure 15: Submenu for setting the display contrast

In the submenu the contrast of the LC display can be adjusted in up to 11 levels (0 greatest contrast ... 10 low contrast) by pressing the display buttons - or +. After that, if both display buttons are pressed at the same time (**OK**), the push button sensor accepts the selection as a valid new setting and exits the submenu.

i The default setting is "3" (middle contrast) After an ETS programming operation the contrast is automatically reset to the default value. Settings previously made in the menu are thus lost in case of an ETS programming operation. A device reset due to a bus voltage failure does not reset the contrast set in the menu.

3 Technical data

General

Protection class	III
Mark of approval	KNX/EIB
Ambient temperature	-5 ... +45 °C
Storage/transport temperature	-20 ... +70 °C

KNX/EIB supply

KNX medium	TP
Commissioning mode	S-mode
Rated voltage	DC 21 ... 32 V SELV (Via bus coupler 3)
Power consumption	max. 420 mW (Via bus coupler 3)
Connection mode	10 pole male connector strip

Temperature sensor

Measuring range internal temperature sensor	0 ... 40 °C
Measuring range wired remote temperature sensor	0 ... 50 °C

4 Software description

4.1 Software specification

ETS search paths:	- push button / push button, 2fold / Push button sensor 3 Plus 2-gang - push button / push button, 5fold / Push button sensor 3 Plus 5-gang (2+3)
Configuration:	S-mode standard
PEI type:	"00" _{Hex} / "0" _{Dec}
PEI connector:	No PEI! Electrical connection via 10pole pin contact strip exclusively with a bus coupling unit 3.

Application for push button sensor 3 plus 2gang:

No.	Short description	Name	Version	from mask version
1	Multifunctional room temperature controller & push button sensor application with display. 2 control surfaces for button sensor function and 1 display operating rocker switch.	Push button sensor 3 plus 2-gang 10E211	1.1 for ETS3.0 Version d onwards and ETS4	705
2	Multifunctional room temperature controller & push button sensor application with display. 2 control surfaces for button sensor function and 1 display operating rocker switch. Expanded scope of functions: configurable step width for setpoint shift on the controller and on controller extensions. Configurable behaviour when accepting a setpoint shift set locally on the device (application with or without OK).	Push button sensor 3 plus 2-gang 10E212	1.2 for ETS3.0 Version f and ETS4	705

Application for push button sensor 3 plus 5gang:

No.	Short description	Name	Version	from mask version
1	Multifunctional room temperature controller & push button sensor application with display. 5 control surfaces for button sensor function and 1 display operating rocker switch.	Push button sensor 3 plus 5-gang 10E511	1.1 for ETS3.0 Version d onwards and ETS4	705

2	Multifunctional room temperature controller & push button sensor application with display. 5 control surfaces for button sensor function and 1 display operating rocker switch. Expanded scope of functions: configurable step width for setpoint shift on the controller and on controller extensions. Configurable behaviour when accepting a setpoint shift set locally on the device (application with or without OK).	Push button sensor 3 plus 5-gang 10E512	1.2 for ETS3.0 Version f and ETS4	705
---	--	---	--	-----

4.2 Software "Push button sensor 3 plus"

4.2.1 Scope of functions

Functions of the integrated push button sensor

- Each operating area can either be used as a single rocker or as two independent buttons.
- For push button function either double-surface or single-surface principle.
- Each rocker can be used for the functions 'switching', 'dimming', 'venetian bling', '1 byte value transmitter', '2-byte value transmitter', 'scene extension', '2-channel operation' and 'manual fan control'.
- Each button can be used for the functions 'switching', 'dimming', 'venetian blind', '1 byte value transmitter', '2 byte value transmitter', 'scene extension', '2-channel operation', 'controller extension', 'controller operation', 'heating timer operation' and 'manual fan control'.
- 2-channel control is possible: each rocker or each button can be set for controlling two independent channels. This means that only one button-press is enough to transmit up to two telegrams to the bus. The channels can be configured independently of one another for the Switching, Value transmitter (1 byte) or Temperature value transmitter (2 bytes) functions.
- For the rocker functions Dimming, Venetian blind (operation concept "Long – Short or Short") and 2-channel operation, full-surface rocker actuation can also be evaluated. With full-surface rocker operation, switching telegrams and scene recall requests can be triggered on the bus in addition to and independently of the configured rocker function.
- The switching function permits the following settings: reaction after pressing and/or releasing, switch on, switch off, and toggle.
- The dimming function permits the following settings: times for short and long actuation, dimming in different levels, telegram repetition on long press, transmission of stop telegram after end of press.
- The shutter control permits the following settings: four different operation concepts with times for short and long press and slat adjustment.
- The 1-byte and 2-byte value transmitter function permits the following settings: selection of the value range (0 ... 100 %, 0 ... 255, 0 ... 65535, 0 ... 1500 lux, 0 ... 40 °C), value on button-press, value change on sustained button-press with different step widths, optional overflow on reaching the end of a value range.
- The controller extension function or controller operation permits the following settings: operating mode switch-over (defined selection of an operating mode or change between different operating modes for a controller extension), change of presence status, setpoint shift.
- Each operating area has two status LEDs.
- When a status LED is internally connected with the rocker or the button, it can signal a button-press or the current status of a communication object. The status indication can also be in inverted form.
- When a status LED is not dependent on the rocker or button, it can be permanently on or off, indicate the status of an independent communication object, the operating state of a room temperature controller or the result of a comparison between signed or unsigned 1 byte values.
- The colour of the status LEDs (red, green, blue) can be configured in the ETS either globally or separately, as required. Optionally a superposed function can be activated via the bus, in which the colour and display information of individual status LEDs can be changed according to priority.
- A delay to the automatically transmitted communication objects of the controller external after a device reset can be configured. The delay time is automatically produced by the subscriber address (physical address).
- The rockers or buttons can be disabled via a 1-bit object. During an active disable, all or some of the rockers / buttons can have no function, can perform the function of a selected button or execute one of two presettable disabling functions.

Functions of the integrated room temperature controller

- Various operating modes can be activated: Comfort, Standby, Night and Frost/heat protection
- Each operating mode can be assigned its own temperature-setpoints (for heating and/or cooling).
- Configuring the temperature setpoints as relative (derived from basic setpoint) or absolute (independent setpoint temperatures for each operating mode).
- Comfort extension possible using presence button in Night or Frost/heat protection mode. Configurable duration of the comfort extension.
- Operating mode switchover via 1-byte objects according to the KNX specification or using up to four individual 1-bit objects.
- Status feedback telegrams (also KNX compliant) can be configured.
- Frost/heat protection switchover via window status or by automatic frost protection.
- Indication of room temperature controller information via the device display
- Function buttons to operate the controller (setpoint shift and configuration menu, for example to change the setpoint temperatures).
- Operating modes "Heating", "Cooling", "Heating and cooling" each with or without additional level. The temperature setpoints for the additional level are derived via a configurable level offset from the values of the basic level.
- Optionally one control circuit or two control circuits. In the case of two control circuits, the same or different setpoint temperatures can be configured.
- Various control types can be configured for each heating or cooling level: PI control (permanent or switching PWM) or 2-point feedback control (switching).
- Control parameter for PI controller (if desired: proportional range, reset time) and 2-point controller (hysteresis) adjustable.
- Automatic or object oriented switch-over between "heating" and "cooling".
- Setpoint shifting with temporary relative setpoint presetting or permanent setpoint shifting through operation of the function or display buttons on the device or via communication objects possible (e.g. using a controller extension). Indication of the setpoint shift on the device display can be implemented by means of a bar graph.
- Only for application version 1.2: configurable step width for setpoint shift (0.1 K / 0.5 K / 1.0 K).
- Deactivating the feedback control or the additional level possible using separate 1-bit objects.
- Internal temperature sensor and up to two external temperature sensors (1 x object, 1 x wired) possible for room temperature measurement.
- Configurable internal to external determination of measured value and external sensors for room temperature measurement. Request time of the externally received temperature value can be set.
- The room temperature measurement (actual value) can be adjusted separately for the internal and external sensor using parameters.
- The actual and setpoint temperatures can be output on the bus if a configurable deviation is detected (also periodically).
- Separate or shared command value output in heating and cooling mode. This produces one or two command value objects for each level.
- Normal or inverted command value output configurable
- Automatic transmission and cycle-time for actuating output configurable
- Command value limit possible.
- Clipping mode (response of the controller to command values = 100 %) can be set.

Functions of the integrated controller extension

- Alternatively to the function of the room temperature controller, the extension mode can be activated. This allows control of an external room temperature controller.
- Full control of the controller (operating modes, presence functions and setpoint shift).
- Full-featured indication of the controller status on the display of the extension (heating / cooling reporting, setpoint shift, room temperature, setpoint temperature and current operating mode).
- Room temperature measurement also possible on the extension.

Functions of the LC display

- The device's graphics display has 103 x 40 pixels and is equipped with switchable LED backlighting. The display is subdivided into various display areas, depending on the configuration in the ETS, the operating state and the specific device functions that are activated.
- 1-area or 2-area display. With two display areas, depiction of icons for displaying the various operating modes of the room temperature controller or the controller extension. Moreover it is optionally possible to display in the status line the time (left justified) and additional temperature values of the controller extension (right-justified) in a one-line or two-line format. In addition it is possible to display values that have been received by KNX/EIB via separate communication objects in various data and depiction formats. When only one display area is used, depiction of temperature values with a large character set and indication of the operating mode of the room temperature controller.
- Each item of display information in the menu area can be supplemented with additional texts that are freely definable in the ETS.
- The menu area of the display can optionally be used to show alarm texts and comment text up to 14 characters long in a two-line format. These text displays override all normal displays in this area, and thus can provide direct information about various system states, for example the states of KNX/EIB alarm centres or facility systems.
- Alternatively, display of push button assistance texts. The push button assistance can be used to give the user help texts about how to use the button or rocker when a button is pressed on the display (intelligent nameplate).

General functions

- The labelling field of the push button can be illuminated. The labelling field can be permanently on or off or alternatively be switched via a communication object.
- Alternatively, communication object control can be used to change the brightness of all status LEDs, the labelling field and the backillumination of the display. This makes it possible, for example, to reduce the brightness during nighttime hours to a value configured in the ETS.
- All LEDs of the push button sensor can flash simultaneously in the event of an alarm. The following settings are possible: Value of alarm signalling object for the states alarm / no alarm, alarm acknowledge by actuation of a button, transmission of the acknowledge signal to other devices.
- Internal clock to indicate the time on the device display and for controlling the heating timer. The time and week information must be made available to the device regularly using a communication object (e.g. by a KNX/EIB system clock).
- Integrated scene control. Internal storage of up to eight scenes with eight output channels, recall of internal scenes by means of a presettable scene number, selection of object types for the output channels; for each scene, the storage of the individual output values and the transmission of the output values can be permitted or inhibited; the individual channels can be delayed during scene recall; as scene extension, 64 scenes can be recalled and stored.

4.2.2 Notes on software

ETS project design and commissioning

For configuration and commissioning of the device with the Version 1.1 application program, ETS3.0 from Version "d" Patch "A" onwards or ETS4 is required. The product database is offered in the *.VD4 format.

When using the Version 1.2 application project, at least ETS3.0 of Version "f" onwards or ETS4 is required for configuration and commissioning of the device. The product database is offered in the *.VD5 format.

Device combination with a bus coupling unit 3

The pushbutton sensor must be plugged onto the flush-mounted bus coupling unit 3 (see Accessories). Only the combination of this bus coupling unit and the pushbutton sensor cover results in a functional unit. The device configuration is not programmed into the bus coupling unit. Therefore it is possible to operate devices that have already been put into operation on any desired third-generation bus coupling units. This can simplify commissioning significantly, because programming of the devices no longer has to be performed on the same bus coupling unit that the pushbutton sensor will later be plugged onto in the building.

- i Plugging the pushbutton sensor onto a flush-mounted bus coupling unit 1 or 2 (older generation) is not possible in some cases, and generally not intended, and as a result the device combination will not function.

4.2.3 Object table

Number of communication objects:	96 (2x variant) 120 (5x variant) (max. object number 171 - gaps in between)
Number of addresses (max):	254
Number of assignments (max):	255
Dynamic table management	No

4.2.3.1 Object table, push button sensor function section

Objects for rocker or button function

Function:	Switching				
Object	Function	Name	Type	DPT	Flag
 ⁰	Switching	B.rocker/button 1 ₁	1-bit	1.xxx	C, W, T, (R) ³
Description	1-bit object for transmission of switching telegrams (ON, OFF).				

Function:	Dimming				
Object	Function	Name	Type	DPT	Flag
 ⁰	Switching	B.rocker/button 1 ₁	1-bit	1.xxx	C, W, T, (R) ³
Description	1-bit object for transmission of switching telegrams (ON, OFF).				

Function:	Dimming				
Object	Function	Name	Type	DPT	Flag
 ¹⁴	Dimming	B.rocker/button 1 ₁	4-bit	3.007	C, W, T, (R) ³
Description	4-bit object for the transmission of relative dimming telegrams.				

Function:	Venetian blind				
Object	Function	Name	Type	DPT	Flag
 ⁰	Short time operation	B.rocker/button 1 ₁	1-bit	1.007	C, -, T, (R) ₃
Description	1-bit object for the transmission of telegrams with which a Venetian blind or shutter drive motor can be stopped or with which the blind slats can be adjusted by short time operation.				

1: The number of rockers or buttons depends on the planned device variant.

2: The objects have been described for rocker 1 or button 1 as an example. The objects for the other rockers/buttons are defined in the same way by shifting the object number and changing the object name.

3: For reading, the R-flag must be set. The last value written to the object via the bus or by the device will be read.

Function: Venetian blind

Object	Function	Name	Type	DPT	Flag
 ¹⁴	Long-time operation	B.rocker/button 1 ₁ ,	1-bit	1.008	C, W, T, (R) ³

Description 1-bit object for the transmission of telegrams with which a Venetian blind or shutter drive motor can be moved upwards or downwards.

Function: 1-byte value transmitter

Object	Function	Name	Type	DPT	Flag
 ⁰	Value	B.rocker/button 1 ₁ ,	1 byte	5.xxx	C, W, T, (R) ³

Description 1-byte object for the transmission of values from 0 to 255 (corresponding to values from 0 % to 100 %). If the adjustment of the value is enabled, the object can transmit telegrams cyclically after long actuation with which the value can be reduced or increased by a presettable amount.

Function: 2-byte value transmitter

Object	Function	Name	Type	DPT	Flag
 ⁰	Value	B.rocker/button 1 ₁ ,	2 byte	7.xxx	C, W, T, (R) ³

Description 2-byte object for the transmission of values from 0 to 65535. If the adjustment of the value is enabled, the object can transmit cyclical telegrams after a long press with which the value can be reduced or increased by an adjustable amount.

Function: 2-byte value transmitter

Object	Function	Name	Type	DPT	Flag
 ⁰	Temperature value	B.rocker/button 1 ₁ ,	2 byte	9.001	C, W, T, (R) ³

Description 2 -byte object for the transmission of a temperature value from 0 °C to 40 °C. If the adjustment of the value is enabled, the object can transmit telegrams cyclically after a long press with which the value can be reduced or increased by 1 K.

Function: 2-byte value transmitter

Object	Function	Name	Type	DPT	Flag
 ⁰	Brightness value	B.rocker/button 1 ₁ ,	2 byte	9.004	C, W, T, (R) ³

Description 2-byte object for the transmission of a brightness level value from 0 to 1500 lux. If the adjustment of the value is enabled, the object can transmit cyclical telegrams after a long press with which the value can be reduced or increased by 50 lux.

1: The number of rockers or buttons depends on the planned device variant.

2: The objects have been described for rocker 1 or button 1 as an example. The objects for the other rockers/buttons are defined in the same way by shifting the object number and changing the object name.

3: For reading, the R-flag must be set. The last value written to the object via the bus or by the device will be read.

Function: Scene extension

Object	Function	Name	Type	DPT	Flag
 ⁰	Scene extension	B.rocker/button 1 _{1,}	1 byte	18.001	C, -, T, (R) ₃

Description 1-byte object for recalling or for storing one of 64 scenes max. from a scene push button sensor.

Function: 2-channel operation

Object	Function	Name	Type	DPT	Flag
 ⁰	Channel 1 switching	B.rocker/button 1 _{1,}	1-bit	1.xxx	C, W, T, (R) ₃ ³

Description 1-bit object for the transmission of switching telegrams, if 2-channel operation is activated.

Function: 2-channel operation

Object	Function	Name	Type	DPT	Flag
 ⁰	Channel 1 value	B.rocker/button 1 _{1,}	1 byte	5.xxx	C, -, T, (R) ₃

Description 1-byte object for the transmission of value telegrams, if 2-channel operation is activated.

Function: 2-channel operation

Object	Function	Name	Type	DPT	Flag
 ⁰	Channel 1 value	B.rocker/button 1 _{1,}	2 byte	9.001	C, -, T, (R) ₃

Description 2-byte object for the transmission of value telegrams, if 2-channel operation is activated.

Function: 2-channel operation

Object	Function	Name	Type	DPT	Flag
 ¹⁴	Channel 2 switching	B.rocker/button 1 _{1,}	1-bit	1.xxx	C, W, T, (R) ₃ ³

Description 1-bit object for the transmission of switching telegrams, if 2-channel operation is activated.

1: The number of rockers or buttons depends on the planned device variant.

2: The objects have been described for rocker 1 or button 1 as an example. The objects for the other rockers/buttons are defined in the same way by shifting the object number and changing the object name.

3: For reading, the R-flag must be set. The last value written to the object via the bus or by the device will be read.

Function: 2-channel operation

Object	Function	Name	Type	DPT	Flag
 ¹⁴	Channel 2 value	B.rocker/button 1 _{1,}	1 byte	5.xxx	C, -, T, (R) ₃

Description 1-byte object for the transmission of value telegrams, if 2-channel operation is activated.

Function: 2-channel operation

Object	Function	Name	Type	DPT	Flag
 ¹⁴	Channel 2 value	B.rocker/button 1 _{1,}	2 byte	9.001	C, -, T, (R) ₃

Description 2-byte object for the transmission of value telegrams, if 2-channel operation is activated.

Objects for full-surface operation with rocker function (with dimming, venetian blind and 2-channel operation)

Function: Full-surface operation

Object	Function	Name	Type	DPT	Flag
 ¹	Switching	B.Rocker 1 full-surface actuation _{1,}	1-bit	1.xxx	C, W, T, (R) ₃

Description 1-bit object for the transmission of switching telegrams (ON, OFF) when there is full-surface operation of an operating area.

Function: Full-surface operation

Object	Function	Name	Type	DPT	Flag
 ¹	Scene extension	B.Rocker 1 full-surface actuation _{1,}	1 byte	18.001	C, -, T, (R) ₃

Description 1-byte object for recalling or for storing one of 64 scenes max. from a scene push button sensor in case of full-surface operation of an operating area.

1: The number of rockers or buttons depends on the planned device variant.

2: The objects have been described for rocker 1 or button 1 as an example. The objects for the other rockers/buttons are defined in the same way by shifting the object number and changing the object name.

3: For reading, the R-flag must be set. The last value written to the object via the bus or by the device will be read.

Objects for status LED

Function: Status LED in case of rocker function					
Object	Function	Name	Type	DPT	Flag
 ²⁸	Switching	B.Status LED 1 ¹	1-bit	1.xxx	C, W, -, (R) ₂
Description 1-bit object for activation of the status LED.					

Function: Status LED in case of rocker function					
Object	Function	Name	Type	DPT	Flag
 ²⁸	Value	B.Status LED 1 ¹	1 byte	5.xxx, 6.xxx, 20.102	C, W, -, (R) ₂
Description 1-byte object for activation of the status LED.					

Function: Status LED in case of rocker function					
Object	Function	Name	Type	DPT	Flag
 ²⁹	Switching	B.Status LED 1 ¹	1-bit	1.xxx	C, W, -, (R) ₂
Description 1-bit object for activation of the status LED.					

Function: Status LED in case of rocker function					
Object	Function	Name	Type	DPT	Flag
 ²⁹	Value	B.Status LED 1 ¹	1 byte	5.xxx, 6.xxx, 20.102	C, W, -, (R) ₂
Description 1-byte object for activation of the status LED.					

Function: Status LED in case of push button function					
Object	Function	Name	Type	DPT	Flag
 ²⁸	Switching	B.Status LED 1 ¹	1-bit	1.xxx	C, W, -, (R) ₂
Description 1-bit object for activation of the status LED.					

Function: Status LED in case of push button function					
Object	Function	Name	Type	DPT	Flag
 ²⁸	Value	B.Status LED 1 ¹	1 byte	5.xxx, 6.xxx, 20.102	C, W, -, (R) ₂
Description 1-byte object for activation of the status LED.					

1: The number of status LEDs depends on the configured device variant.

2: For reading, the R-flag must be set. The last value written to the object via the bus will be read.

Function: Superposed function for the status LED

Object	Function	Name	Type	DPT	Flag
 ⁴⁰	Superposed switching function	B.Status LED 1 ¹	1-bit	1.xxx	C, W, -, (R) ²

Description 1-byte object for forced-control activation of the status LEDs. This can be used to change the colour and display information of individual status LEDs according to priority.

Function: Superposed function for the status LED

Object	Function	Name	Type	DPT	Flag
 ⁴⁰	Superposed value function	B.Status LED 1 ¹	1 byte	5.xxx, 6.xxx, 20.102	C, W, -, (R) ²

Description 1-byte object for forced-control activation of the status LEDs. This can be used to change the colour and display information of individual status LEDs according to priority.

Objects for disabling functions

Function: Switching

Object	Function	Name	Type	DPT	Flag
 ^{12, 13}	Switching	B.Disabling function 1 / B.Disabling function 2	1-bit	1.xxx	C, W, T, (R) ²

Description 1-bit object for transmission of switching telegrams (ON, OFF).

Function: Dimming

Object	Function	Name	Type	DPT	Flag
 ^{12, 13}	Switching	B.Disabling function 1 / B.Disabling function 2	1-bit	1.xxx	C, W, T, (R) ²

Description 1-bit object for transmission of switching telegrams (ON, OFF).

1: The number of status LEDs depends on the configured device variant.

2: For reading, the R-flag must be set. The last value written to the object via the bus will be read.

Function: Dimming

Object	Function	Name	Type	DPT	Flag
 26, 27	Dimming	B.Disabling function 1 / B.Disabling function 2	4-bit	1.007	C, W, T, (R) ¹

Description 4-bit object for the transmission of relative dimming telegrams.

Function: Venetian blind

Object	Function	Name	Type	DPT	Flag
 12, 13	Short time operation	B.Disabling function 1 / B.Disabling function 2	1-bit	1.007	C, -, T, (R) 1

Description 1-bit object for the transmission of telegrams with which a Venetian blind or shutter drive motor can be stopped or with which the blind slats can be adjusted by short time operation.

Function: Venetian blind

Object	Function	Name	Type	DPT	Flag
 26, 27	Long-time operation	B.Disabling function 1 / B.Disabling function 2	1-bit	1.008	C, W, T, (R) ¹

Description 1-bit object for the transmission of telegrams with which a Venetian blind or shutter drive motor can be moved upwards or downwards.

Function: 1-byte value transmitter

Object	Function	Name	Type	DPT	Flag
 12, 13	Value	B.Disabling function 1 / B.Disabling function 2	1 byte	5.xxx	C, W, T, (R) ¹

Description 1-byte object for the transmission of values from 0 to 255 (corresponding to values from 0 % to 100 %). If the adjustment of the value is enabled, the object can transmit telegrams cyclically after long actuation with which the value can be reduced or increased by a presettable amount.

Function: 2-byte value transmitter

Object	Function	Name	Type	DPT	Flag
 12, 13	Value	B.Disabling function 1 / B.Disabling function 2	2 byte	7.xxx	C, W, T, (R) ¹

Description 2-byte object for the transmission of values from 0 to 65535. If the adjustment of the value is enabled, the object can transmit cyclical telegrams after a long press with which the value can be reduced or increased by an adjustable amount.

1: For reading, the R-flag must be set. The last value written to the object via the bus will be read.

Function: 2-byte value transmitter

Object	Function	Name	Type	DPT	Flag
 12, 13	Temperature value	B.Disabling function 1 / B.Disabling function 2	2 byte	9.001	C, W, T, (R) ¹

Description 2 -byte object for the transmission of a temperature value from 0 °C to 40 °C. If the adjustment of the value is enabled, the object can transmit telegrams cyclically after a long press with which the value can be reduced or increased by 1 K.

Function: 2-byte value transmitter

Object	Function	Name	Type	DPT	Flag
 12, 13	Brightness value	B.Disabling function 1 / B.Disabling function 2	2 byte	9.004	C, W, T, (R) ¹

Description 2-byte object for the transmission of a brightness level value from 0 to 1500 lux. If the adjustment of the value is enabled, the object can transmit cyclical telegrams after a long press with which the value can be reduced or increased by 50 lux.

Function: Scene extension

Object	Function	Name	Type	DPT	Flag
 12, 13	Scene extension	B.Disabling function 1 / B.Disabling function 2	1 byte	18.001	C, -, T, (R) ₁

Description 1-byte object for recalling or for storing one of 64 scenes max. from a scene push button sensor.

Function: 2-channel operation

Object	Function	Name	Type	DPT	Flag
 12, 13	Channel 1 switching	B.Disabling function 1 / B.Disabling function 2	1-bit	1.xxx	C, W, T, (R) ¹

Description 1-bit object for the transmission of switching telegrams, if 2-channel operation is activated.

Function: 2-channel operation

Object	Function	Name	Type	DPT	Flag
 12, 13	Channel 1 value	B.Disabling function 1 / B.Disabling function 2	1 byte	5.xxx	C, -, T, (R) ₁

Description 1-byte object for the transmission of value telegrams, if 2-channel operation is activated.

1: For reading, the R-flag must be set. The last value written to the object via the bus will be read.

Function: 2-channel operation

Object	Function	Name	Type	DPT	Flag
 12, 13	Channel 1 value	B.Disabling function 1 / B.Disabling function 2	2 byte	9.001	C, -, T, (R) ₁

Description 2-byte object for the transmission of value telegrams, if 2-channel operation is activated.

Function: 2-channel operation

Object	Function	Name	Type	DPT	Flag
 26, 27	Channel 2 switching	B.Disabling function 1 / B.Disabling function 2	1-bit	1.xxx	C, W, T, (R) ₁

Description 1-bit object for the transmission of switching telegrams, if 2-channel operation is activated.

Function: 2-channel operation

Object	Function	Name	Type	DPT	Flag
 26, 27	Channel 2 value	B.Disabling function 1 / B.Disabling function 2	1 byte	5.xxx	C, -, T, (R) ₁

Description 1-byte object for the transmission of value telegrams, if 2-channel operation is activated.

Function: 2-channel operation

Object	Function	Name	Type	DPT	Flag
 26, 27	Channel 2 value	B.Disabling function 1 / B.Disabling function 2	2 byte	9.001	C, -, T, (R) ₁

Description 2-byte object for the transmission of value telegrams, if 2-channel operation is activated.

Function: Disabling function

Object	Function	Name	Type	DPT	Flag
 54	Disabling	B.Disable buttons	1-bit	1.001	C, W, -, (R) ₁

Description 1-bit object by means of which the push button sensor can be disabled and enabled again (polarity configurable).

1: For reading, the R-flag must be set. The last value written to the object via the bus will be read.

Objects for the labelling field illumination

Function: Labelling field illumination

Object	Function	Name	Type	DPT	Flag
 52	Switching	B.Labelling field illumination	1-bit	1.001	C, W, -, (R) 1

Description 1-bit object for switching the labelling field illumination on or off. The telegram polarity can be configured.

Function: LED brightness night reduction

Object	Function	Name	Type	DPT	Flag
 53	Switching	B.LED night reduction	1-bit	1.001	C, W, -, (R) 1

Description 1-bit object for activating and deactivating the night reduction (changed brightness of all LEDs). This makes it possible, for example, to reduce the brightness during nighttime hours to a value configured in the ETS ("1" = night reduction ON; "0" = night reduction OFF).

Objects for alarm message

Function: Alarm signal

Object	Function	Name	Type	DPT	Flag
 56	Switching	Alarm signal	1-bit	1.xxx	C, W, -, (R) 1

Description 1-bit object for the reception of an alarm signalling (polarity configurable).

Function: Alarm signal

Object	Function	Name	Type	DPT	Flag
 57	Switching	Alarm message acknowledge	1-bit	1.xxx	C, -, T, (R) 2

Description 1-bit object for transmitting the acknowledgement of an alarm signalling (polarity configurable).

1: For reading, the R-flag must be set. The last value written to the object via the bus will be read.

2: For reading, the R-flag must be set. The last value written to the object via the bus or by the device will be read.

Objects for the controller extension

Function: Controller extension

Object	Function	Name	Type	DPT	Flag
 58	Operating mode switchover	B.Controller extension	1 byte	20.102	C, W, T, (R) ¹

Description: 1-byte object for changing over a room temperature controller between the Comfort, Standby, Night and Frost/heat protection operating modes.

Function: Controller extension

Object	Function	Name	Type	DPT	Flag
 59	Operating mode forced-control	B.Controller extension	1 byte	20.102	C, W, T, (R) ¹

Description: 1-byte object for changing over a room temperature controller under forced control between the Automatic, Comfort, Standby, Night and Frost / heat protection operating modes.

Function: Controller extension

Object	Function	Name	Type	DPT	Flag
 60	Presence button	B.Controller extension	1-bit	1.001	C, W, T, (R) ¹

Description: 1-bit object for changing over the presence status of a room temperature controller (polarity configurable).

Function: Controller extension

Object	Function	Name	Type	DPT	Flag
 61	Setpoint shift specification	B.Controller extension	1 byte	6.010	C, -, T, (R) ¹

Description: 1-byte object for presetting a basic setpoint shift for a controller.
 $x \leq 0 \leq y$ (0 = no shift active); integral numbers
 Value object 62 + 1 (increase level value)
 Value object 62 - 1 (decrease level value)
 The possible range of values (x to y) is fixed by the setpoint adjusting range in connection with the level value on the room temperature controller.

Function: Controller extension

Object	Function	Name	Type	DPT	Flag
 62	Current setpoint shift	B.Controller extension	1 byte	6.010	C, W, T, (R) ¹

Description: 1-byte object used by the extension unit for receiving the current setpoint shift of the room temperature controller.
 $x \leq 0 \leq y$ (0 = no shift active); integral numbers
 The possible range of values (x to y) is fixed by the setpoint adjusting range in connection with the level value on the room temperature controller.

1: For reading, the R-flag must be set. The last value written to the object via the bus or by the device will be read.

Function: Controller extension

Object	Function	Name	Type	DPT	Flag
 63	Controller status	D.Input controller extension	1 byte	Not defined	C, W, T, (R) ¹

Description 1-byte object used by the extension unit for receiving the current state of operation of the controller. Status LEDs that can be used to indicate a status independently of a button function can display one of the various information units which are grouped in this byte (bit-oriented evaluation). Only when "Controller status" = "Controller general".

Function: Controller extension

Object	Function	Name	Type	DPT	Flag
 90	KNX status operating mode	D.Input controller extension	1 byte	20.102	C, W, T, (R) ¹

Description 1-byte object for that the display of the controller extension can use to switch between the Comfort, Standby, Night and Frost/heat protection operating modes. Only when "Controller status" = "KNX compliant".

Function: Controller extension

Object	Function	Name	Type	DPT	Flag
 91	Heating message	D.Input controller extension	1-bit	1.001	C, W, T, (R) ¹

Description 1-bit object for reporting to the controller extension (display) a request for heating energy. Object value = "1": energy request, object value = "0": no energy request.

Function: Controller extension

Object	Function	Name	Type	DPT	Flag
 92	Cooling message	D.Input controller extension	1-bit	1.001	C, W, T, (R) ¹

Description 1-bit object for reporting to the controller extension (display) a request for cooling energy. Object value = "1": energy request, object value = "0": no energy request

Function: Controller extension

Object	Function	Name	Type	DPT	Flag
 104	Setpoint temperature	D.Input controller extension	2 byte	9.001	C, W, T, R

Description 2-byte object for transmission of the controller setpoint temperature to the controller extension (display). Depending on the controller operating mode, the possible range of values is limited by the configured frost protection and/or heat protection temperature. The temperature value must always be output in the format "°C".

1: For reading, the R-flag must be set. The last value written to the object via the bus will be read.

Function: Controller extension

Object	Function	Name	Type	DPT	Flag
 108	Status signal addition	D.Input controller extension	1 byte	Not defined	C, W, T, (R) ¹

Description 1-byte object used by the extension unit for receiving the current enlarged state of operation of the controller.
Only when "Controller status" = "Controller general".

Function: Controller extension

Object	Function	Name	Type	DPT	Flag
 109	KNX status	D.Input controller extension	2 byte	22.101	C, W, T, (R) ²

Description 2-byte object used by the extension unit for receiving the current state of operation of the controller.
Only when "Controller status" = "KNX compliant".

Function: Controller extension

Object	Function	Name	Type	DPT	Flag
 110	KNX status forced operating mode	D.Input controller extension	1 byte	20.102	C, W, T, (R) ²

Description 1-byte object for that the display of the controller extension can use under forced control to switch between the Comfort, Standby, Night and Frost/heat protection operating modes.
Only when "Controller status" = "KNX compliant".

Object for light scene function

Function: Light scene function

Object	Function	Name	Type	DPT	Flag
 66...-73	Switching	B.Scene-output 1 ³	1-bit	1.001	C, W, T, (R) ¹

Description 1-bit objects for controlling up to eight actuator groups (ON, OFF).

Function: Light scene function

Object	Function	Name	Type	DPT	Flag
 66...-73	Value	B.Scene-output 1 ³	1 byte	5.001	C, W, T, (R) ¹

Description 1-byte objects for controlling up to eight actuator groups (0...255).

1: For reading, the R-flag must be set. The last value written to the object via the bus or by the device will be read.

2: For reading, the R-flag must be set. The last value written to the object via the bus will be read.

3: Scene outputs 2 ... 8 see scene output 1, shift of the object number (66 + number of scene output - 1).

Function: Light scene function

Object	Function	Name	Type	DPT	Flag
 ⁷⁴	Extension unit input	B.Scene	1 byte	18.001	C, W, -, (R) 1

Description 1-byte object with which one of the eight internally stored scenes can be recalled or stored again.

1: For reading, the R-flag must be set. The last value written to the object via the bus will be read.

4.2.3.2 Object table, controller function section

Objects for room temperature measurement

Function:	Room temperature measurement				
Object	Function	Name	Type	DPT	Flag
 ⁶⁴	Actual temperature	C.Output	2 byte	9.001	C, -, T, R
Description	2-byte object for the display of the actual temperature (room temperature), which is determined by the controller or controller extension. Possible value range: -99.9 °C to +99.9 °C / Measurement range of internal temperature sensor: 0 °C to +40 °C. The temperature value is always output in the format "°C".				

Function:	Room temperature measurement				
Object	Function	Name	Type	DPT	Flag
 ⁶⁵	Received temperature	C.Input	2 byte	9.001	C, W, -, (R) 1
Description	2-byte object for coupling an external KNX/EIB room temperature sensor or a controller extension. Thus cascading of multiple temperature sensors for room temperature measurement. Possible range of values: -99.9 °C to +99.9 °C. The temperature value must always be specified in the format "°C".				

Function:	Room temperature measurement				
Object	Function	Name	Type	DPT	Flag
 ⁷⁵	External sensor	C.Output	2 byte	9.001	C, -, T, R
Description	2-byte object for transmitting the temperature value measured via the wired remote sensor to the bus. Possible value range: -99.9 °C to +99.9 °C / Measurement range of sensor: 0 °C to +50 °C. The temperature value is always output in the format "°C".				

Object for heating timer

Function:	Heating timer				
Object	Function	Name	Type	DPT	Flag
 ⁷⁷	Disabling heating timer	C.Input	1-bit	1.001	C, W, -, (R) 1
Description	1-bit object for disabling the integrated heating timer. The telegram polarity can be configured.				

1: For reading, the R-flag must be set. The last value written to the object via the bus will be read.

Object for setpoint temperature specification

Function: Setpoint temperature specification

Object	Function	Name	Type	DPT	Flag
 ⁸⁰	Basic setpoint	C.Input	2 byte	9.001	C, W, -, (R) ₁

Description 2-byte object for external setting of the basic setpoint for for the first control circuit for relative setpoint presetting. Depending on the operating mode, the possible range of values is limited by the configured frost protection and/or heat protection temperature. The controller rounds the temperature values received via the object to the specific step width of the setpoint shift. This is dependent upon the application program used. In Version 1.2 applications, the step width can be configured in the ETS (0.1 K / 0.5 K / 1.0 K). In Version 1.1 applications, the step width is permanently defined as 0.1 K. The temperature value must always be specified in the format "°C".

Function: Setpoint temperature specification

Object	Function	Name	Type	DPT	Flag
 ⁸¹	Basic setpoint	C.Input control circuit 2	2 byte	9.001	C, W, -, (R) ₁

Description 2-byte object for external setting of the basic setpoint for for the second control circuit for relative setpoint presetting and separate setpoints for the two control circuits. Depending on the operating mode, the possible range of values is limited by the configured frost protection and/or heat protection temperature. The controller rounds the temperature values received via the object to the specific step width of the setpoint shift. This is dependent upon the application program used. In Version 1.2 applications, the step width can be configured in the ETS (0.1 K / 0.5 K / 1.0 K). In Version 1.1 applications, the step width is permanently defined as 0.1 K. The temperature value must always be specified in the format "°C". This object is only available in this way if two control circuits are configured with separated setpoints.

Function: Setpoint temperature specification

Object	Function	Name	Type	DPT	Flag
 ⁸⁰	Setpoint active operating mode	C.Input / C.Input control circuit 1	2 byte	9.001	C, W, (T), (R) ²

Description 2-byte object for external setting of a setpoint for absolute setpoint presetting. Depending on the operating mode, the possible range of values is limited by the configured frost protection and/or heat protection temperature. The controller rounds the temperature values received via the object to the specific step width of the setpoint shift. This is dependent upon the application program used. In Version 1.2 applications, the step width can be configured in the ETS (0.1 K / 0.5 K / 1.0 K). In Version 1.1 applications, the step width is permanently defined as 0.1 K. The temperature value must always be specified in the format "°C". The setpoint modified by the setpoint shift can be reported back to the bus via the object by setting the "Transmit" flag.

1: For reading, the R-flag must be set. The last value written to the object via the bus will be read.

2: For reading, the R-flag must be set. The last value written to the object via the bus or by the device will be read.

Function: Setpoint temperature specification

Object	Function	Name	Type	DPT	Flag
 ⁸¹	Setpoint active operating mode	C.Input control circuit 2	2 byte	9.001	C, W, (T), (R) ¹

Description 2-byte object for external setting of a setpoint for for the second control circuit for absolute setpoint presetting and separate setpoints for the two control circuits Depending on the operating mode, the possible range of values is limited by the configured frost protection and/or heat protection temperature. The controller rounds the temperature values received via the object to the specific step width of the setpoint shift. This is dependent upon the application program used. In Version 1.2 applications, the step width can be configured in the ETS (0.1 K / 0.5 K / 1.0 K). In Version 1.1 applications, the step width is permanently defined as 0.1 K. The temperature value must always be specified in the format "°C". This object is only available in this way if two control circuits are configured with separated setpoints. The setpoint modified by the setpoint shift can be reported back to the bus via the object by setting the "Transmit" flag.

Objects for operating mode change-over

Function: Operating mode switchover

Object	Function	Name	Type	DPT	Flag
 ⁸²	Operating mode switchover	C.Input	1 byte	20.102	C, W, T, (R) ¹

Description 1-byte object for change-over of the operating mode of the controller according to the KNX specification. This object is only available in this way when the operating mode change-over is to take place over 1 byte (parameter-dependent).

Function: Operating mode switchover

Object	Function	Name	Type	DPT	Flag
 ⁸²	Comfort mode	C.Input	1-bit	1.001	C, W, T, (R) ¹

Description 1-bit object for change-over to the "Comfort" operating mode. This object is only available in this way when the operating mode change-over is to take place over 4 x 1 bit (parameter-dependent).

Function: Operating mode switchover

Object	Function	Name	Type	DPT	Flag
 ⁸³	Standby mode	C.Input	1-bit	1.001	C, W, T, (R) ¹

Description 1-bit object for change-over to the "Standby" operating mode. This object is only available in this way when the operating mode change-over is to take place over 4 x 1 bit (parameter-dependent).

1: For reading, the R-flag must be set. The last value written to the object via the bus or by the device will be read.

Function: Operating mode switchover

Object	Function	Name	Type	DPT	Flag
 ⁸⁴	Night operation	C.Input	1-bit	1.001	C, W, T, (R) ¹

Description 1-bit object for change-over to the "Night" operating mode. This object is only available in this way when the operating mode change-over is to take place over 4 x 1 bit (parameter-dependent).

Function: Operating mode switchover

Object	Function	Name	Type	DPT	Flag
 ⁸⁵	Frost/heat protection	C.Input	1-bit	1.001	C, W, T, (R) ¹

Description 1-bit object for change-over to the "Frost / heat protection" operating mode. This object is only available in this way when the operating mode change-over is to take place over 4 x 1 bit (parameter-dependent).

Function: Operating mode switchover

Object	Function	Name	Type	DPT	Flag
 ⁸⁶	Operating mode forced-control	C.Input	1 byte	20.102	C, W, T, (R) ¹

Description 1-byte object for forced change-over (highest priority) of the operating mode of the controller according to the KNX specification. This object is only available in this way when the operating mode change-over is to take place over 1 byte (parameter-dependent).

Function: Operating mode change-over presence detection

Object	Function	Name	Type	DPT	Flag
 ⁸⁷	Presence object	C.Input / Output	1-bit	1.001	C, W, T, (R) ¹

Description 1-bit object through which a motion detector or an external presence button (e.g. from a controller extension) can be linked to the controller. The object also transmits the state of a presence button of the device to the bus. Polarity: presence detected = "1", presence not detected = "0".

Function: Operating mode change-over window status

Object	Function	Name	Type	DPT	Flag
 ⁸⁸	Window status	C.Input	1-bit	1.019	C, W, -, (R) ²

Description 1-bit object for the coupling of window contacts. Polarity: Window open = "1", window closed = "0".

1: For reading, the R-flag must be set. The last value written to the object via the bus or by the device will be read.

2: For reading, the R-flag must be set. The last value written to the object via the bus will be read.

Object for operating mode change-over

Function: Operating mode change-over

Object	Function	Name	Type	DPT	Flag
 ⁸⁹	Heating / cooling change-over	C.Input	1-bit	1.100	C, (W), T, (R) ¹

Description: 1-bit object to transmit the automatically set operating mode of the controller to specify the operating mode ("Heating" or "Cooling").
Object value "1" = Heating; Object value "0" = Cooling.

Object for controller status

Function: Controller status

Object	Function	Name	Type	DPT	Flag
 ⁹⁰	Controller status	C.Output	1-bit	1.001	C, -, T, (R) ₁

Description: 1-bit object for single status feedback of configured controller functions. This object is only available in this way when a part of the controller status is to be transmitted singly as 1-bit information (parameter-dependent).

Function: Controller status

Object	Function	Name	Type	DPT	Flag
 ⁹⁰	Controller status	C.Output	1 byte	--- ²	C, -, T, (R) ₁

Description: 1-byte object used by the controller to output the current state of operation (e.g. to a controller extension).
Only when "Controller status" = "Controller general".

Function: Controller status

Object	Function	Name	Type	DPT	Flag
 ⁹⁰	KNX status operating mode	C.Output	1 byte	20.102	C, -, T, (R) ₁

Description: 1-byte object used by the controller to output the current operating mode. This object is generally used to enable controller extensions to display the controller operating mode correctly in the KNX compliant status display. Therefore this object should be connected with controller extensions if the KNX compliant status feedback is not configured.
Only when "Controller status" = "KNX compliant".

1: For reading, the R-flag must be set. The last value written to the object via the bus or by the device will be read.

2: Non-standardised DP type (in accordance with KNX AN 097/07 rev 3).

Function:	Controller status				
Object	Function	Name	Type	DPT	Flag
 ¹⁰⁸	Status signal addition	C.Output	1 byte	--- ¹	C, -, T, (R) ₂
Description	1-byte object used by the controller to output the current enlarged state of operation (e.g. to a controller extension). Only when "Controller status" = "Controller general".				

Function:	Controller status				
Object	Function	Name	Type	DPT	Flag
 ¹⁰⁹	KNX status	C.Output	2 byte	22.101	C, -, T, (R) ₂
Description	1-byte object that the controller uses to display elementary basic functions in a KNX-harmonised manner. Only when "Controller status" = "KNX compliant".				

Function:	Controller status				
Object	Function	Name	Type	DPT	Flag
 ¹¹⁰	KNX status forced oper. mode	C.Output	1 byte	20.102	C, -, T, (R) ₂
Description	1-byte object used by the controller to output the operating mode in the event of forced position. This object is generally used to enable controller extensions to display the controller operating mode correctly in the KNX compliant status display. Therefore this object should be connected with controller extensions if the KNX compliant status feedback is not configured. Only when "Controller status" = "KNX compliant".				

Objects for heating / cooling signal functions

Function:	Heating energy message				
Object	Function	Name	Type	DPT	Flag
 ⁹¹	Heating message	C.Output	1-bit	1.001	C, -, T, (R) ₂
Description	1-bit object for the controller to report a request for heating energy. Object value = "1": energy request, object value = "0": no energy request.				

Function:	Cooling energy message				
Object	Function	Name	Type	DPT	Flag
 ⁹²	Cooling message	C.Output	1-bit	1.001	C, -, T, (R) ₂
Description	1-bit object for the controller to report a request for cooling energy. Object value = "1": energy request, object value = "0": no energy request.				

1: Non-standardised DP type.

2: For reading, the R-flag must be set. The last value written to the object via the bus or by the device will be read.

Objects for controller disabling functions

Function: Disable controller

Object	Function	Name	Type	DPT	Flag
 ⁹³	Disable controller operation	C.Input	1-bit	1.001	C, W, -, (R) 1

Description 1-bit object for deactivating the controller operation. Polarity:
Operation disabled = "1", Operation enabled = "0".

Function: Disable controller

Object	Function	Name	Type	DPT	Flag
 ⁹⁴	Disable controller	C.Input	1-bit	1.001	C, W, -, (R) 1

Description 1-bit object for deactivating the controller (activating dew point operation / first and second control circuit). Polarity:
Controller deactivated = "1", controller activated = "0".

Function: Disable controller

Object	Function	Name	Type	DPT	Flag
 ⁹⁵	Disable additional level	C.Input	1-bit	1.001	C, W, -, (R) 1

Description 1-bit object for deactivating the additional level of the controller. Polarity:
Additional level deactivated = "1", additional level activated = "0". This object is only available in this way if two-level heating or cooling operation is configured.

Function: Disable controller

Object	Function	Name	Type	DPT	Flag
 ⁹⁵	Disable control circuit 2	C.Input	1-bit	1.001	C, W, -, (R) 1

Description 1-bit object for separate deactivating of the second control circuit. Polarity:
control circuit 2 deactivated = "1", control circuit 2 activated = "0". This object is only available in this way if two control circuits are configured.

1: For reading, the R-flag must be set. The last value written to the object via the bus will be read.

Object for heating command value output and combined valve heating/cooling

Function: Command value

Object	Function	Name	Type	DPT	Flag
 ⁹⁶	Command value for heating / command value, basic heating	C.Output	1 byte	5.001	C, -, T, (R) 1

Description 1-byte object to output the continuous command value of the heating mode. In two-level heating mode, command value output for the basic heating. This object is only available in this way if the type of feedback control is configured to "Continuous PI control".

Function: Command value

Object	Function	Name	Type	DPT	Flag
 ⁹⁶	Command value for heating (PWM) / command value, basic heating (PWM)	C.Output	1-bit	1.001	C, -, T, (R) 1

Description 1-bit object to output the PWM command value of the heating mode. In two-level heating mode, command value output for the basic heating. This object is only available in this way if the type of feedback control is configured to "Switching PI control (PWM)".

Function: Command value

Object	Function	Name	Type	DPT	Flag
 ⁹⁶	Command value for heating / command value, basic heating	C.Output	1-bit	1.001	C, -, T, (R) 1

Description 1-bit object to output the switching command value of the heating mode. In two-level heating mode, command value output for the basic heating. This object is only available in this way if the type of feedback control is configured to "Switching 2-point feedback control".

Function: Command value

Object	Function	Name	Type	DPT	Flag
 ⁹⁶	Command value for heating/cooling / command value, basic level	C.Output	1 byte	5.001	C, -, T, (R) 1

Description 1-byte object to output the combined continuous command value of the heating and cooling mode. In two-level heating/cooling mode, command value output for the basic level. This object is only available in this way if the command values for heating and cooling mode are output to a shared object (parameter-dependent). The type of feedback control must also be configured to "Continuous PI control".

1: For reading, the R-flag must be set. The last value written to the object via the bus or by the device will be read.

Function:	Command value				
Object	Function	Name	Type	DPT	Flag
 ⁹⁶	Command value for heating/cooling (PWM) / command value, basic level (PWM)	C.Output	1-bit	1.001	C, -, T, (R) 1

Description 1-bit object to output the combined PWM command value of the heating and cooling mode. In two-level heating/cooling mode, command value output for the basic level This object is only available in this way if the command values for heating and cooling mode are output to a shared object (parameter-dependent). The type of feedback control must also be configured to "Switching PI control (PWM)".

Function:	Command value				
Object	Function	Name	Type	DPT	Flag
 ⁹⁶	Command value for heating/cooling / command value, basic level	C.Output	1-bit	1.001	C, -, T, (R) 1

Description 1-bit object to output the combined switching command value of the heating and cooling mode. In two-level heating/cooling mode, command value output for the basic level This object is only available in this way if the command values for heating and cooling mode are output to a shared object (parameter-dependent). The type of feedback control must also be configured to "Switching 2-point feedback control".

Object for command value output, additional heating and combined valve additional heating/cooling

Function:	Command value				
Object	Function	Name	Type	DPT	Flag
 ⁹⁷	Command value, additional heating	C.Output	1 byte	5.001	C, -, T, (R) 1

Description 1-byte object to output the continuous command value for additional heating in two-level operation. This object is only available in this way if the type of feedback control is configured to "Continuous PI control".

Function:	Command value				
Object	Function	Name	Type	DPT	Flag
 ⁹⁷	Command value, additional heating (PWM)	C.Output	1-bit	1.001	C, -, T, (R) 1

Description 1-bit object to output the continuous PWM command value for additional heating in two-level operation. This object is only available in this way if the type of feedback control is configured to "Switching PI control (PWM)".

1: For reading, the R-flag must be set. The last value written to the object via the bus or by the device will be read.

Function:	Command value				
Object	Function	Name	Type	DPT	Flag
 ⁹⁷	Command value, additional heating	C.Output	1-bit	1.001	C, -, T, (R) ₁
Description	1-byte object to output the switching command value for additional heating in two-level operation. This object is only available in this way if the type of feedback control is configured to "Switching 2-point feedback control".				

Function:	Command value				
Object	Function	Name	Type	DPT	Flag
 ⁹⁷	Cmd. value, add. level	C.Output	1 byte	5.001	C, -, T, (R) ₁
Description	1-byte object to output the combined continuous command value for additional level in two-level operation. This object is only available in this way if the command values for heating and cooling mode are output to a shared object (parameter-dependent). The type of feedback control must also be configured to "Continuous PI control".				

Function:	Command value				
Object	Function	Name	Type	DPT	Flag
 ⁹⁷	Cmd. value, add. level (PWM)	C.Output	1-bit	1.001	C, -, T, (R) ₁
Description	1-bit object to output the combined switching PWM command value for additional level in two-level operation. This object is only available in this way if the command values for heating and cooling mode are output to a shared object (parameter-dependent). The type of feedback control must also be configured to "Switching PI control (PWM)".				

Function:	Command value				
Object	Function	Name	Type	DPT	Flag
 ⁹⁷	Cmd. value, add. level	C.Output	1-bit	1.001	C, -, T, (R) ₁
Description	1-bit object to output the combined switching command value for additional level in two-level operation. This object is only available in this way if the command values for heating and cooling mode are output to a shared object (parameter-dependent). The type of feedback control must also be configured to "Switching 2-point feedback control".				

1: For reading, the R-flag must be set. The last value written to the object via the bus or by the device will be read.

Object for command value output, cooling

Function:	Command value				
Object	Function	Name	Type	DPT	Flag
 ⁹⁸	Command value for cooling / command value, basic cooling	C.Output	1 byte	5.001	C, -, T, (R) 1
Description	1-byte object to output the continuous command value of the cooling mode. In two-level cooling mode, command value output for the basic cooling. This object is only available in this way if the type of feedback control is configured to "Continuous PI control".				

Function:	Command value				
Object	Function	Name	Type	DPT	Flag
 ⁹⁸	Command value for cooling (PWM) / command value, basic cooling (PWM)	C.Output	1-bit	1.001	C, -, T, (R) 1
Description	1-bit object to output the PWM command value of the cooling mode. In two-level cooling mode, command value output for the basic cooling. This object is only available in this way if the type of feedback control is configured to "Switching PI control (PWM)".				

Function:	Command value				
Object	Function	Name	Type	DPT	Flag
 ⁹⁸	Command value for cooling / command value, basic cooling	C.Output	1-bit	1.001	C, -, T, (R) 1
Description	1-bit object to output the switching command value of the cooling mode. In two-level cooling mode, command value output for the basic cooling. This object is only available in this way if the type of feedback control is configured to "Switching 2-point feedback control".				

Object for command value output, additional cooling

Function:	Command value				
Object	Function	Name	Type	DPT	Flag
 ⁹⁹	Command value, additional cooling	C.Output	1 byte	5.001	C, -, T, (R) 1
Description	1-byte object to output the continuous command value for additional cooling in two-level operation. This object is only available in this way if the type of feedback control is configured to "Continuous PI control".				

1: For reading, the R-flag must be set. The last value written to the object via the bus or by the device will be read.

Function:	Command value				
Object	Function	Name	Type	DPT	Flag
 ⁹⁹	Command value, additional cooling (PWM)	C.Output	1-bit	1.001	C, -, T, (R) 1
Description	1-bit object to output the continuous PWM command value for additional cooling in two-level operation. This object is only available in this way if the type of feedback control is configured to "Switching PI control (PWM)".				

Function:	Command value				
Object	Function	Name	Type	DPT	Flag
 ⁹⁹	Command value, additional cooling	C.Output	1-bit	1.001	C, -, T, (R) 1
Description	1-byte object to output the switching command value for additional cooling in two-level operation. This object is only available in this way if the type of feedback control is configured to "Switching 2-point feedback control".				

Object for additional PWM heating command value output and combined valve PWM additional heating/cooling

Function:	Command value				
Object	Function	Name	Type	DPT	Flag
 ¹⁰⁰	PWM command value for heating / PWM command value, basic heating	C.Output	1 byte	5.001	C, -, T, (R) 1
Description	1-byte object to output the internal continuous command value of a PWM controller of the heating mode. In two-level heating mode, command value output for the basic heating. This object is only available in this way if the type of feedback control is configured to "Switching PI control (PWM)". In addition to the switching 1 bit command value of the PWM, the calculated continuous command value of the controller can also be transmitted to the bus and displayed, e.g. in a visualisation.				

Function:	Command value				
Object	Function	Name	Type	DPT	Flag
 ¹⁰⁰	PWM command value for heating/cooling / PWM command value, basic level	C.Output	1 byte	5.001	C, -, T, (R) 1
Description	1-byte object to output the combined continuous command value of a PWM controller of the heating and cooling mode. In two-level heating/cooling mode, command value output for the basic level This object is only available in this way if the command values for heating and cooling mode are output to a shared object (parameter-dependent). The type of feedback control must also be configured to "Switching PI control (PWM)". In addition to the switching 1 bit command value of the PWM, the calculated continuous command value of the controller can also be transmitted to the bus and displayed, e.g. in a visualisation.				

1: For reading, the R-flag must be set. The last value written to the object via the bus or by the device will be read.

Object for additional command value output, PWM additional heating and combined valve PWM additional heating/cooling

Function:	Command value				
Object	Function	Name	Type	DPT	Flag
 ¹⁰¹	PWM command value, additional heating	C.Output	1 byte	5.001	C, -, T, (R) 1
Description	1-byte object to output the internal continuous command value of a PWM controller for additional heating in two-level operation. This object is only available in this way if the type of feedback control is configured to "Continuous PI control". In addition to the switching 1 bit command value of the PWM, the calculated continuous command value of the controller can also be transmitted to the bus and displayed, e.g. in a visualisation.				

Function:	Command value				
Object	Function	Name	Type	DPT	Flag
 ¹⁰¹	PWM comm. value, add. level	C.Output	1 byte	5.001	C, -, T, (R) 1
Description	1-byte object to output the combined continuous command value of a PWM feedback controller for additional level in two-level operation. This object is only available in this way if the command values for heating and cooling mode are output to a shared object (parameter-dependent). The type of feedback control must also be configured to "Switching PI control (PWM)". In addition to the switching 1 bit command value of the PWM, the calculated continuous command value of the controller can also be transmitted to the bus and displayed, e.g. in a visualisation.				

Object for additional command value output, PWM cooling

Function:	Command value				
Object	Function	Name	Type	DPT	Flag
 ¹⁰²	PWM command value for cooling / PWM command value, basic cooling	C.Output	1 byte	5.001	C, -, T, (R) 1
Description	1-byte object to output the internal continuous command value of a PWM feedback controller of the cooling mode. In two-level cooling mode, command value output for the basic cooling. This object is only available in this way if the type of feedback control is configured to "Switching PI control (PWM)". In addition to the switching 1 bit command value of the PWM, the calculated continuous command value of the controller can also be transmitted to the bus and displayed, e.g. in a visualisation.				

1: For reading, the R-flag must be set. The last value written to the object via the bus or by the device will be read.

Object for additional command value output, PWM additional cooling

Function:	Command value				
Object	Function	Name	Type	DPT	Flag
 103	PWM command value, additional cooling	C.Output	1 byte	5.001	C, -, T, (R) 1
Description	1-byte object to output the internal continuous command value of a PWM feedback controller for additional cooling in two-level operation. This object is only available in this way if the type of feedback control is configured to "Switching PI control (PWM)". In addition to the switching 1 bit command value of the PWM, the calculated continuous command value of the controller can also be transmitted to the bus and displayed, e.g. in a visualisation.				

Objects for command value output for heating with two control circuits

Function:	Command value				
Object	Function	Name	Type	DPT	Flag
 96	Command value for heating	C.Output control circuit 1	1 byte	5.001	C, -, T, (R) 1
Description	1-byte object to output the continuous command value of the heating mode for the first control circuit. This object is only available in this way if the type of feedback control is configured to "Continuous PI control" and if two control circuits are configured.				

Function:	Command value				
Object	Function	Name	Type	DPT	Flag
 96	Cmd. value, heating (PWM)	C.Output control circuit 1	1-bit	1.001	C, -, T, (R) 1
Description	1-bit object to output the continuous PWM command value of the heating mode for the first control circuit. This object is only available in this way if the type of feedback control is configured to "Switching PI control (PWM)" and if two control circuits are configured.				

Function:	Command value				
Object	Function	Name	Type	DPT	Flag
 96	Command value for heating	C.Output control circuit 1	1-bit	1.001	C, -, T, (R) 1
Description	1-bit object to output the switching command value of the heating mode for the first control circuit. This object is only available in this way if the type of feedback control is configured to "Switching 2-point feedback control" and if two control circuits are configured.				

1: For reading, the R-flag must be set. The last value written to the object via the bus or by the device will be read.

Function:	Command value				
Object	Function	Name	Type	DPT	Flag
 ¹⁰⁰	Command value for heating	C.Output control circuit 2	1 byte	5.001	C, -, T, (R) ₁
Description	1-byte object to output the continuous command value of the heating mode for the second control circuit. This object is only available in this way if the type of feedback control is configured to "Continuous PI control" and if two control circuits are configured.				

Function:	Command value				
Object	Function	Name	Type	DPT	Flag
 ¹⁰⁰	Cmd. value, heating (PWM)	C.Output control circuit 2	1-bit	1.001	C, -, T, (R) ₁
Description	1-bit object to output the continuous PWM command value of the heating mode for the second control circuit. This object is only available in this way if the type of feedback control is configured to "Switching PI control (PWM)" and if two control circuits are configured.				

Function:	Command value				
Object	Function	Name	Type	DPT	Flag
 ¹⁰⁰	Command value for heating	C.Output control circuit 2	1-bit	1.001	C, -, T, (R) ₁
Description	1-bit object to output the switching command value of the heating mode for the second control circuit. This object is only available in this way if the type of feedback control is configured to "Switching 2-point feedback control" and if two control circuits are configured.				

Objects for command value output for cooling with two control circuits

Function:	Command value				
Object	Function	Name	Type	DPT	Flag
 ⁹⁸	Command value for cooling	C.Output control circuit 1	1 byte	5.001	C, -, T, (R) ₁
Description	1-byte object to output the continuous command value of the cooling mode for the first control circuit. This object is only available in this way if the type of feedback control is configured to "Continuous PI control" and if two control circuits are configured.				

1: For reading, the R-flag must be set. The last value written to the object via the bus or by the device will be read.

Function:	Command value				
Object	Function	Name	Type	DPT	Flag
 ⁹⁸	Cmd. value, cooling (PWM)	C.Output control circuit 1	1-bit	1.001	C, -, T, (R) ₁
Description	1-bit object to output the continuous PWM command value of the cooling mode for the first control circuit. This object is only available in this way if the type of feedback control is configured to "Switching PI control (PWM)" and if two control circuits are configured.				

Function:	Command value				
Object	Function	Name	Type	DPT	Flag
 ⁹⁸	Command value for cooling	C.Output control circuit 1	1-bit	1.001	C, -, T, (R) ₁
Description	1-bit object to output the switching command value of the cooling mode for the first control circuit. This object is only available in this way if the type of feedback control is configured to "Switching 2-point feedback control" and if two control circuits are configured.				

Function:	Command value				
Object	Function	Name	Type	DPT	Flag
 ¹⁰²	Command value for cooling	C.Output control circuit 2	1 byte	5.001	C, -, T, (R) ₁
Description	1-byte object to output the continuous command value of the cooling mode for the second control circuit. This object is only available in this way if the type of feedback control is configured to "Continuous PI control" and if two control circuits are configured.				

Function:	Command value				
Object	Function	Name	Type	DPT	Flag
 ¹⁰²	Cmd. value, cooling (PWM)	C.Output control circuit 2	1-bit	1.001	C, -, T, (R) ₁
Description	1-bit object to output the continuous PWM command value of the cooling mode for the second control circuit. This object is only available in this way if the type of feedback control is configured to "Switching PI control (PWM)" and if two control circuits are configured.				

Function:	Command value				
Object	Function	Name	Type	DPT	Flag
 ¹⁰²	Command value for cooling	C.Output control circuit 2	1-bit	1.001	C, -, T, (R) ₁
Description	1-bit object to output the switching command value of the cooling mode for the second control circuit. This object is only available in this way if the type of feedback control is configured to "Switching 2-point feedback control" and if two control circuits are configured.				

1: For reading, the R-flag must be set. The last value written to the object via the bus or by the device will be read.

Object for outputting the setpoint temperature

Function: Setpoint temperature

Object	Function	Name	Type	DPT	Flag
 104	Setpoint temperature	C.Output / C.Output control circuit 1	2 byte	9.001	C, -, T, R

Description 2-byte object for the output of the current temperature-setpoint of the first control circuit. Depending on the operating mode, the possible range of values is limited by the configured frost protection and/or heat protection temperature. The temperature value is always output in the format "°C".

Function: Setpoint temperature

Object	Function	Name	Type	DPT	Flag
 105	Setpoint temperature	C.Output control circuit 2	2 byte	9.001	C, -, T, R

Description 2-byte object for the output of the current temperature-setpoint of the second control circuit. Depending on the operating mode, the possible range of values is limited by the configured frost protection and/or heat protection temperature. The temperature value is always output in the format "°C". This object is only available in this way if two control circuits are configured with separated setpoints.

Object for basic setpoint shift (only for relative setpoint presetting)

Function: Basic setpoint shift

Object	Function	Name	Type	DPT	Flag
 106	Current setpoint shift	C.Output	1 byte	6.010	C, -, T, R

Description 1-byte object for giving feedback on the current setpoint shifting to a controller extension. The value of a counter value in the communication object is aligned to the specified step width of the setpoint shift. This is dependent upon the application program used. In Version 1.2 applications, the step width can be configured in the ETS (0.1 K / 0.5 K / 1.0 K). In Version 1.1 applications, the step width is permanently defined as 0.1 K. The value "0" means that no shift is active. The value is depicted in a double complement in the positive and negative direction. This object is only available in this way if relative setpoint presetting is configured.

Function: Basic setpoint shift

Object	Function	Name	Type	DPT	Flag
 ¹⁰⁷	Setpoint shift specification	C.Input	1 byte	6.010	C, W, -, (R) 1

Description 1-byte object for setting a basic setpoint shifting, e.g. of a controller extension. The value of a counter value in the communication object is aligned to the specified step width of the setpoint shift. This is dependent upon the application program used. In Version 1.2 applications, the step width can be configured in the ETS (0.1 K / 0.5 K / 1.0 K). In Version 1.1 applications, the step width is permanently defined as 0.1 K. The value "0" means that no shift is active. The value is depicted in a double complement in the positive and negative direction. In case the limits of the value range are exceeded by the preset external value, the controller will automatically reset the received value to the minimum and maximum limits. This object is only available in this way if relative setpoint presetting is configured.

Objects for command value limit

Function: Command value limit

Object	Function	Name	Type	DPT	Flag
 ¹¹¹	Command value limit	C.Input / C.Input control circuit 1	1-bit	1.001	C, W, -, (R) 1

Description 1-bit object for activating or deactivating the command value limit of the first control circuit. Polarity: Limitation activated = "1", Limitation deactivated = "0".

Function: Command value limit

Object	Function	Name	Type	DPT	Flag
 ¹¹²	Command value limit	C.Input control circuit 2	1-bit	1.001	C, W, -, (R) 1

Description 1-bit object for activating or deactivating the command value limit of the second control circuit. Polarity: Limitation activated = "1", Limitation deactivated = "0".

1: For reading, the R-flag must be set. The last value written to the object via the bus will be read.

Objects for manual fan control

Function: manual fan control

Object	Function	Name	Type	DPT	Flag
 113	active/inactive	B.manual fan control	1-bit	1.003	C, -, T, (R) 1

Description 1-bit object for forwarding the information to a fan coil actuator that manual fan control should be executed. In the event of a "1" telegram from this object the actuator switches directly from automatic mode to manual operation. In the event of a "0" telegram from this object the actuator switches back to automatic mode and deactivates the manual fan control.
The push button sensor automatically controls the corresponding telegram values when the manual fan control is operated (note feedback! See object "B.Manual fan control feedback").

Function: manual fan control

Object	Function	Name	Type	DPT	Flag
 114	Feedback	B.manual fan control	1-bit	1.002	C, W, -, (R) 2

Description 1-bit object for feedback of the state of the manual fan control from a fan coil actuator to the push button sensor. The switching value of this object allows the push button sensor to detect which operating mode is activated on the actuator. The push button sensor uses this feedback to derive whether automatic mode or manual operation should be shown on the display. Furthermore, the push button sensor requires this information in order to evaluate the state of the operating mode correctly and switch it over if necessary when a rocker switch or pushbutton is operated. Manual fan control has no effect as long as the push button sensor has not received any feedback from the actuator.
Polarity: manual fan control activated = "1", manual fan control deactivated = "0".

Function: manual fan control

Object	Function	Name	Type	DPT	Flag
 115	Specification	B.manual fan control	1-bit	1.007	C, -, T, (R) 1

Description 1-bit object for presetting a fan level for a fan coil actuator using switching direction commands. The push button sensor uses this object to inform the fan coil actuator about the manually set fan level.
This object is only available in this way when the manual fan level change-over is to be performed via a 1-bit object (switching direction presetting). The object must have the same data format as the object of the actuator with the same function!
Polarity: switch fan level up = "1", switch fan level down = "0".

1: For reading, the R-flag must be set. The last value written to the object via the bus or by the device will be read.

2: For reading, the R-flag must be set. The last value written to the object via the bus will be read.

Function: manual fan control

Object	Function	Name	Type	DPT	Flag
 ¹¹⁵	Specification	B.manual fan control	1 byte	5.010	C, -, T, (R) ₁

Description 1-byte object for presetting a fan level for a fan coil actuator using value commands. The push button sensor uses this object to inform the fan coil actuator about the manually set fan level.
 This object is only available in this way when the manual fan level change-over is to be performed via a 1-byte object. The object must have the same data format as the object of the actuator with the same function!

Function: manual fan control

Object	Function	Name	Type	DPT	Flag
 ¹¹⁶	Feedback active fan level	B.manual fan control	1 byte	5.010	C, W, -, (R) ₂

Description 1-byte object for feedback of the fan level set on a fan coil actuator to the push button sensor. To display the active fan level, the push button sensor requires feedback from the fan coil actuator as to which of the fan levels is currently set. Furthermore, the feedback is important for the fan level presetting by the push button sensor, if this is performed via a 1-byte value object.
 This object is only available in this way when the fan level feedback is performed via a 1-byte object. The object must have the same data format as the object of the actuator with the same function!

Function: manual fan control

Object	Function	Name	Type	DPT	Flag
 ¹¹⁶	Feedback for fan level 1	B.manual fan control	1-bit	1.001	C, W, -, (R) ₂

Description 1-bit object for feedback to the push button sensor whether the first fan level is set in the fan coil actuator. To display the active fan level, the push button sensor requires feedback from the fan coil actuator as to which of the fan levels is currently set. Furthermore, the feedback is important for the fan level presetting by the push button sensor, if this is performed via a 1-byte value object.
 This object is only available in this way when the fan level feedback is performed via up to 6 individual 1-bit objects. The object must have the same data format as the object of the actuator with the same function!

1: For reading, the R-flag must be set. The last value written to the object via the bus or by the device will be read.

2: For reading, the R-flag must be set. The last value written to the object via the bus will be read.

Function: manual fan control

Object	Function	Name	Type	DPT	Flag
 ¹¹⁷	Feedback for fan level 2	B.manual fan control	1-bit	1.001	C, W, -, (R) 1

Description 1-bit object for feedback to the push button sensor whether the second fan level is set in the fan coil actuator. To display the active fan level, the push button sensor requires feedback from the fan coil actuator as to which of the fan levels is currently set. Furthermore, the feedback is important for the fan level presetting by the push button sensor, if this is performed via a 1-byte value object.
This object is only available in this way when the fan level feedback is performed via up to 6 individual 1-bit objects. The object must have the same data format as the object of the actuator with the same function!

Function: manual fan control

Object	Function	Name	Type	DPT	Flag
 ¹¹⁸	Feedback for fan level 3	B.manual fan control	1-bit	1.001	C, W, -, (R) 1

Description 1-bit object for feedback to the push button sensor whether the third fan level is set in the fan coil actuator. To display the active fan level, the push button sensor requires feedback from the fan coil actuator as to which of the fan levels is currently set. Furthermore, the feedback is important for the fan level presetting by the push button sensor, if this is performed via a 1-byte value object.
This object is only available in this way when the fan level feedback is performed via up to 6 individual 1-bit objects. The object must have the same data format as the object of the actuator with the same function!

Function: manual fan control

Object	Function	Name	Type	DPT	Flag
 ¹¹⁹	Feedback for fan level 4	B.manual fan control	1-bit	1.001	C, W, -, (R) 1

Description 1-bit object for feedback to the push button sensor whether the fourth fan level is set in the fan coil actuator. To display the active fan level, the push button sensor requires feedback from the fan coil actuator as to which of the fan levels is currently set. Furthermore, the feedback is important for the fan level presetting by the push button sensor, if this is performed via a 1-byte value object.
This object is only available in this way when the fan level feedback is performed via up to 6 individual 1-bit objects. The object must have the same data format as the object of the actuator with the same function!

1: For reading, the R-flag must be set. The last value written to the object via the bus will be read.

Function: manual fan control

Object	Function	Name	Type	DPT	Flag
 ¹²⁰	Feedback for fan level 5	B.manual fan control	1-bit	1.001	C, W, -, (R) 1

Description 1-bit object for feedback to the push button sensor whether the fifth fan level is set in the fan coil actuator. To display the active fan level, the push button sensor requires feedback from the fan coil actuator as to which of the fan levels is currently set. Furthermore, the feedback is important for the fan level presetting by the push button sensor, if this is performed via a 1-byte value object.
This object is only available in this way when the fan level feedback is performed via up to 6 individual 1-bit objects. The object must have the same data format as the object of the actuator with the same function!

Function: manual fan control

Object	Function	Name	Type	DPT	Flag
 ¹²¹	Feedback for fan level 6	B.manual fan control	1-bit	1.001	C, W, -, (R) 1

Description 1-bit object for feedback to the push button sensor whether the sixth fan level is set in the fan coil actuator. To display the active fan level, the push button sensor requires feedback from the fan coil actuator as to which of the fan levels is currently set. Furthermore, the feedback is important for the fan level presetting by the push button sensor, if this is performed via a 1-byte value object.
This object is only available in this way when the fan level feedback is performed via up to 6 individual 1-bit objects. The object must have the same data format as the object of the actuator with the same function!

1: For reading, the R-flag must be set. The last value written to the object via the bus will be read.

4.2.3.3 Display object table

Object for setting the internal clock

Function:	Time signal				
Object	Function	Name	Type	DPT	Flag
 ⁷⁶	Time	D.Input	3 byte	10.001	C, W, -, (R) 1
Description	3-byte object for setting the internal clock. The time is required for indication on the display or to control the heating timer (incl. day of the week) and the valve protection. The weekday information is obtained from the KNX/EIB time telegram.				

Objects for display control

Function:	Value display				
Object	Function	Name	Type	DPT	Flag
 ⁷⁸	Value	D.Input row 1	1 byte	5.0xx, 6.0xx	C, W, -, (R) 1
Description	1-byte object for activation of the value display for display line 1. This object is only available in this way if the display function is parameterised for value display with a 1-byte display format (date).				

Function:	Value display				
Object	Function	Name	Type	DPT	Flag
 ⁷⁸	Value	D.Input row 1	2 byte	7.xxx, 8.xxx, 9.xxx	C, W, -, (R) 1
Description	2-byte object for activation of the value display for display line 1. This object is only available in this way if the display function is parameterised for value display with a 2-byte display format (date).				

Function:	Value display				
Object	Function	Name	Type	DPT	Flag
 ⁷⁸	Value	D.Input row 1	4 byte	12.xxx, 13.xxx, 14.xxx	C, W, -, (R) 1
Description	4-byte object for activation of the value display for display line 1. This object is only available in this way if the display function is parameterised for value display with a 4-byte display format (date).				

1: For reading, the R-flag must be set. The last value written to the object via the bus will be read.

Function:	Value display				
Object	Function	Name	Type	DPT	Flag
 ⁷⁸	ASCII text	D.Input row 1	14 byte	16.00x	C, W, -, (R) 1

Description 14-byte object for activation of the value display for display line 1.
This object is only available in this way if the display function is parameterised for value display with a 14-byte display format (ASCII text).

Function:	Value display				
Object	Function	Name	Type	DPT	Flag
 ⁷⁸	Time value display	D.Input row 1	3 byte	10.001	C, W, -, (R) 1

Description 3-byte object for activation of the value display for display line 1.
This object is only available in this way if the display function is parameterised for value display with a 3-byte display format (time).

Function:	Value display				
Object	Function	Name	Type	DPT	Flag
 ⁷⁸	Date value display	D.Input row 1	3 byte	11.001	C, W, -, (R) 1

Description 3-byte object for activation of the value display for display line 1.
This object is only available in this way if the display function is parameterised for value display with a 3-byte display format (date).

Function:	Value display				
Object	Function	Name	Type	DPT	Flag
 ⁷⁹	Value	D.Input row 2	1 byte	5.0xx, 6.0xx	C, W, -, (R) 1

Description 1-byte object for activation of the value display for display line 2.
This object is only available in this way if the display function is parameterised for value display with a 1-byte display format (date).

Function:	Value display				
Object	Function	Name	Type	DPT	Flag
 ⁷⁹	Value	D.Input row 2	2 byte	7.xxx, 8.xxx, 9.xxx	C, W, -, (R) 1

Description 2-byte object for activation of the value display for display line 2.
This object is only available in this way if the display function is parameterised for value display with a 2-byte display format (date).

1: For reading, the R-flag must be set. The last value written to the object via the bus will be read.

Function: Value display

Object	Function	Name	Type	DPT	Flag
 ⁷⁹	Value	D.Input row 2	4 byte	12.xxx, 13.xxx, 14.xxx	C, W, -, (R) 1

Description 4-byte object for activation of the value display for display line 2.
This object is only available in this way if the display function is parameterised for value display with a 4-byte display format (date).

Function: Value display

Object	Function	Name	Type	DPT	Flag
 ⁷⁹	ASCII text	D.Input row 2	14 byte	16.00x	C, W, -, (R) 1

Description 14-byte object for activation of the value display for display line 2.
This object is only available in this way if the display function is parameterised for value display with a 14-byte display format (ASCII text).

Function: Value display

Object	Function	Name	Type	DPT	Flag
 ⁷⁹	Time value display	D.Input row 2	3 byte	10.001	C, W, -, (R) 1

Description 3-byte object for activation of the value display for display line 2.
This object is only available in this way if the display function is parameterised for value display with a 3-byte display format (time).

Function: Value display

Object	Function	Name	Type	DPT	Flag
 ⁷⁹	Date value display	D.Input row 2	3 byte	11.001	C, W, -, (R) 1

Description 3-byte object for activation of the value display for display line 2.
This object is only available in this way if the display function is parameterised for value display with a 3-byte display format (date).

Function: Fault message

Object	Function	Name	Type	DPT	Flag
 ¹⁶²	Fault message text	D.Input row 1	14 byte	16.00x	C, W, -, (R) 1

Description 14-byte object for receiving a fault message text (ASCII string) for display line 1.

1: For reading, the R-flag must be set. The last value written to the object via the bus will be read.

Function: Fault message

Object	Function	Name	Type	DPT	Flag
 163	Fault message text	D.Input row 2	14 byte	16.00x	C, W, -, (R) ₁

Description 14-byte object for receiving a fault message text (ASCII string) for display line 2.

Function: Alarm signal

Object	Function	Name	Type	DPT	Flag
 164	Alarm text	D.Input row 1	14 byte	16.00x	C, W, -, (R) ₁

Description 14-byte object for receiving an alarm message text (ASCII string) for display line 1.

Function: Alarm signal

Object	Function	Name	Type	DPT	Flag
 165	Alarm text	D.Input row 2	14 byte	16.00x	C, W, -, (R) ₁

Description 14-byte object for receiving an alarm message text (ASCII string) for display line 2.

Function: Alarm signal

Object	Function	Name	Type	DPT	Flag
 166	Alarm text acknowledge	D.Input	1-bit	1.xxx	C, -, T, (R) ₂

Description 1-bit object for transmitting an acknowledgement message for alarm messages (polarity configurable).

Function: LCD illumination

Object	Function	Name	Type	DPT	Flag
 167	LCD illumination	D.Input	1-bit	1.001	C, W, -, (R) ₁

Description 1-bit object to switch the backillumination of the LC display (polarity configurable).

1: For reading, the R-flag must be set. The last value written to the object via the bus will be read.

2: For reading, the R-flag must be set. The last value written to the object via the bus or by the device will be read.

Object for detecting the outdoor temperature

Function: Outdoor temperature

Object	Function	Name	Type	DPT	Flag
 ¹⁷¹	Outdoor temperature	R.Input	2 byte	9.001	C, W, -, (R) 1

Description 2-byte object for detecting the outdoor temperature The received value is used solely for the display. Possible range of values: -99.9 °C to +99.9 °C. The temperature value must always be specified in the format "°C".

1: For reading, the R-flag must be set. The last value written to the object via the bus will be read.

4.2.4 Functional description

4.2.4.1 Push button sensor

4.2.4.1.1 General settings

Labelling field illumination

The labelling field illumination of the push button sensor 3 plus is used for different display functions which are in part fixed default functions...

- In a non-programmed device (delivery state), the labelling field illumination flashes at a slow rate of 0.75 Hz.
- To confirm the detection of a full-surface press with the rocker function, the LED flashes with 8 Hz, too.

The application software allows the setting of addition functions using the ETS parameter "Function of the labelling field illumination" on the "General" parameter page...

- For orientation, the labelling field illumination can be switched permanently on or off.
- The LED can display the status of a separate communication object. Here the labelling field illumination can also be activated as flashing with a frequency of approx. 2 Hz.
- The labelling field illumination can be switched on by pressing any desired button and switched off again automatically after a delay time has elapsed. Here the parameter "Time for automatic switch-off" defines the delay until switch-off after the last button-press. Each button-press re-initiates the delay time.
- The illumination can flash together with all other status LEDs with a frequency of about 2 Hz, when the communication object for the alarm signalling is active.

If several of the above states occur at the same time, the following priority is taken into account:

1. Display of a valid full-surface actuation with the rocker function.
2. Display of an alarm.
3. Configuration of "Function of the labelling field illumination".

Transmission delay

After the application program or the physical address is loaded or after the bus voltage is switched on, the push button sensor for the room temperature controller extension unit can transmit telegrams automatically. The push button sensor then requests from the room temperature controller the current state for all the transmitting objects with the name "B.Controller extension" and for the objects "D.Input controller extension". After a device reset, the telegrams for room temperature measurements (external sensor) are also automatically transmitted to the bus.

If in addition to the push button sensor there are still other devices installed in the bus which transmit telegrams immediately after a reset, it may be useful to activate the transmit delay for automatically transmitting objects on the "General" page in order to reduce the bus load.

When transmit delay is activated, the push button sensor determines the value of its individual delay from the device number of its physical address (phys. address: area.line.device number). This value can be about 30 seconds maximum. Without setting a special time delay, this principle prevents multiple push button sensors from trying to transmit telegrams to the bus at the same time.

-  The transmit delay is not active for the rocker and button functions of the push button sensor.

4.2.4.1.2 Operation concept and button evaluation

Operating areas

Depending on the device variant, the push button sensor 3 plus has up to 5 control surfaces that can be used to operate the integrated room temperature controller and the push button sensor. The functions can be configured in the ETS. In addition the push button sensor has 2 display buttons which can be used to check the setpoint temperature of the room temperature controller and to configure additional device settings.

The operation concept of an operating area of the push button sensor function section can be configured in the ETS either as a rocker function or alternatively as a push button function. With the rocker function, one operating area is divided into two neighbouring actuation pressure points with the same basic function. In the push button function either a control surface is divided into 2 functionally separate actuation pressure points (2 buttons), or a control surface is evaluated as single-area operation (only one large button). If a control surface is used as a single rocker function, then it is also possible to trigger special functions using full-surface operation.

When its buttons are pushed, the push button sensor 3 plus sends telegrams to the KNX / EIB, depending on the ETS parameter settings. These can be, for instance, telegrams for switching or push button control, for dimming or for controlling blinds. It is also possible to program value transmitter functions, such as dimming value transmitters, light scene extensions, temperature value transmitters or brightness value transmitters. Insofar as the control surfaces are to operate the integrated room temperature controller, the following functions can be parameterised in the push button configuration: setpoint shift, presence button, operating mode switchover. What is more, a button-press can be used to activate or deactivate the integrated heating timer, and the fan level can be changed over manually on a KNX/EIN fan coil actuator. Moreover, the push button sensor has functions which are not immediately linked with the rockers or buttons and which must therefore be additionally enabled by the corresponding parameters. These include the thermostat extension function, push button function disable, the internal scenes and the display of alarm signals.

The push button sensor 3 plus has two status LEDs per operating area. These status LEDs can either be switched on or off permanently, or can function as a status indicator for a button or rocker. As an alternative, the LEDs can also be activated via separate communication objects. The LEDs can either indicate the switching status of an object statically or by flashing, signal operating states of room temperature controllers, or indicate results of logical value comparison operations.

The colour of the status LEDs (red, green, blue) can be configured in the ETS either globally or separately, as required. Optionally a superposed function can be activated via the bus, in which the colour and display information of individual status LEDs can be changed according to priority.

The labelling field of the push button can be illuminated. If no application has been loaded into the push button sensor with the ETS, the backillumination flashes with a frequency of approx. 0.75 Hz to indicate an error, and in this case the push button sensor does not work.

Operating area as rocker function

In the rocker operating concept, two adjacent actuation pressure points are used as a rocker. The two pressure points are then termed the left and right rocker buttons. Pressing the buttons affect the communication objects assigned to the rocker. Usually, pressing both sides of a socket can directly opposite reactions (e.g. switching: left ON - right OFF / Venetian blind: left UP - right DOWN).

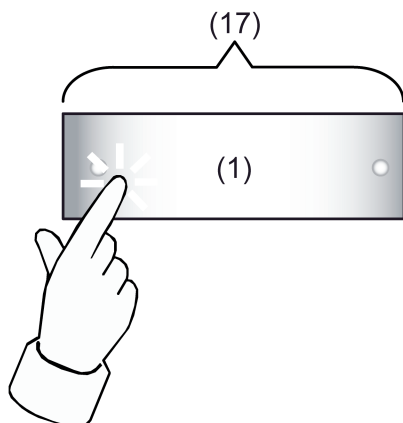

Figure 16: Rocker operation, left

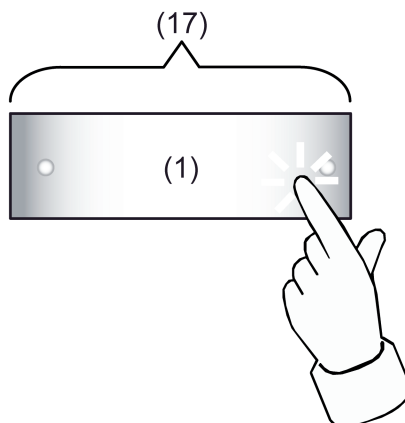

Figure 17: Rocker operation, right

(1) Operating area

(17) Rocker

Full-surface operation

Depending on the function setting of a rocker, full-surface operation can also be optionally configured. This allows execution of additional functions, separate from the basic rocker function. Full-surface operation is simultaneous operation of both actuation pressure points (left / right) of a rocker.

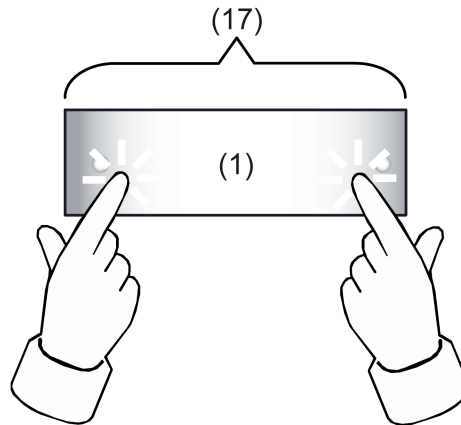

Figure 18: Full-surface rocker operation

(1) Operating area

(17) Rocker

Operating area as button function

With the push button function, a distinction is made whether the operating area is divided into two separate and functionally independent buttons (double-area operation), or whether an operating area functions as a single "large" button (single-area operation).

The parameter "Button evaluation" in the parameter node "Push button sensor" configures either double-surface or single-area operation for each button pair.

In double-area operation the buttons are configured independently of each other, and can fulfil completely different functions (e.g. switching: TOGGLE – thermostat operating mode: Comfort).

i Full-surface actuation of an operating area is not possible as a push button function.

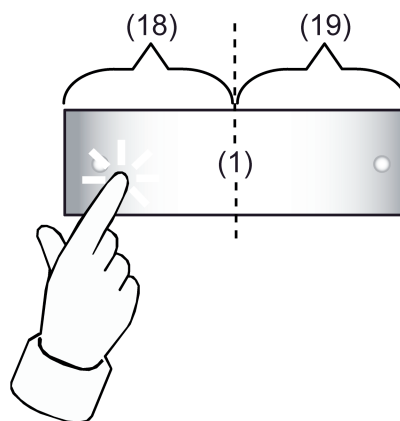

Figure 19: Example for button actuation with configured double-area operation

(1) Operating area

(18) Left button of the operating area

(19) Right button of the operating area

In single-area operation, the entire control surface is evaluated only as a single "large" button. This button is configured independently of the other buttons or rockers of the push button sensor and can fulfil various functions (e.g. Switching: TOGGLE).

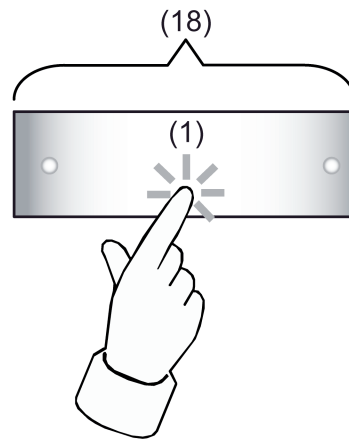

Figure 20: Example of button actuation in configured single-area operation

(1) Operating area

(18) Button of the operating area

- i** With single-area operation, the operating area can be actuated anywhere.
- i** An operating area is always created in the ETS as a button pair. However, because in single-area operation only one button functionally exists, the second button of the button pair has no function and is physically not present. During configuration in the ETS it is shown as a "not present" button without any further button parameters. Only the status LED of this button which is physically not used can be configured separately and if needed also activated via its own communication object.
The physically present button which is to be evaluated in single-area operation is always created as a button with an uneven button number. If, for example, the first operating area of a push button sensor is configured to single-area operation, then button 1 can be configured in the ETS. Button 2 is then the physically not present button without parameters.

4.2.4.1.3 Switching function

For each rocker or each button with the function set to "Switching", the ETS indicates a 1-bit communication object. The parameters of the rocker or button permit fixing the value this object is to adopt on pressing and / or on releasing (ON, OFF, TOGGLE – toggling of the object value). No distinction is made between a brief or long press.

The status LEDs can be configured independently (see page 100).

4.2.4.1.4 Dimming function

For each rocker or each button with the function set to "Dimming", the ETS indicates a 1-bit object and a 4-bit object. Generally, the push button sensor transmits a switching telegram after a brief press and a dimming telegram after a long press. In the standard parameterisation, the push button sensor transmits a telegram for stopping the dimming action after a long press. The time needed by the push button sensor to detect an actuation as a long actuation can be set in the parameters.

The status LEDs can be configured independently (see page 100).

Single-surface and double-surface operation in the dimming function

In the rocker function, the device is preprogrammed for double-surface operation for the dimming function. This means that the push button sensor transmits a telegram for switching on after a brief press and a telegram for increasing the brightness after a long press ("Brighter"). Similarly, the push button sensor transmits a telegram for switching off after a brief press and a telegram for reducing the brightness after a long press ("Darker").

In the separate buttons function, the device is preprogrammed for single-surface dimming function. In this mode, the push button sensor transmits on each brief press ON and OFF telegrams in an alternating pattern ("TOGGLE"). After a long press, the push button sensor transmits "brighter" and "darker" telegrams in an alternating pattern.

The parameter "Command on pressing the button" or "Command on pressing the rocker" on the parameter pages of the buttons or rockers defines the single-surface or double-surface dimming function.

For the rocker and also for the button function, the command issued on pressing the button or rocker can basically be selected at the user's discretion.

With actuator control through multiple control sections (e.g. multiple push-buttons), it is necessary that the actuator reports its switching state back to the 1-bit object of the button or rocker switch. Otherwise, the push-button cannot detect that the actuator has changed its switching status through operation at another point and cannot adjust the dimming direction. The dimming direction is always only evaluated locally and switched over, provided that the actuator does not change its switching status through operation at multiple locations (e.g. lighting ON / only changing the brightness value). The 4-bit dimming objects are not tracked via the bus.

Advanced parameters

For the dimming function, the push button sensor can be programmed with advanced parameters which are hidden in the standard view for greater clarity. If necessary, these advanced parameters can be activated and thus be made visible.

The advanced parameters can be used to determine whether the pushbutton sensor is to cover the full adjusting range of the actuator with one dimming telegram continuously ("Increase brightness by 100 %", "Reduce brightness by 100 %") or whether the dimming range is to be divided into several small levels (50 %, 25 %, 12.5 %, 6 %, 3 %, 1.5 %).

In the continuous dimming mode (100%), the push button sensor transmits a telegram only at the beginning of the long press to start the dimming process and generally a stop telegram after the end of the press. For dimming in small levels it may be useful if the push button sensor repeats the dimming telegram in case of a sustained press for a presettable time (parameter "Telegram repetition"). The stop telegram after the end of the press is then not needed.

When the parameters are hidden ("Advanced parameters = deactivated"), the dimming range is set to 100 %, the stop telegram is activated and the telegram repetition is deactivated.

Full-surface operation

When a rocker is used for dimming, the push button sensor needs some time at the beginning

of each operation in order to distinguish between a short and a long operation. When full-surface operation is enabled, the push button sensor can make use of this time span to evaluate the otherwise invalid simultaneous actuation of both actuation points.

The push button sensor detects a full-surface operation of a rocker, if an operating area is depressed over a large area so that both actuation points of the rocker are actuated. When the push button sensor has detected a valid full-surface actuation, the labelling field illumination flashes quickly at a rate of about 8 Hz for the duration of such actuation. Full-surface operation must have been detected before the first telegram has been transmitted by the dimming function (switching or dimming). If this is not so, even a full-surface operation will be interpreted as a wrong operation and not be executed.

Full-surface actuation is independent. It has a communication object of its own and can optionally be used for switching (ON, OFF, TOGGLE – toggling of the object value) or for scene recall without or with storage function. In the last case, the full-surface actuation causes a scene to be recalled in less than a second. If the push button sensor is to send the telegram for storing a scene, full-surface actuation must be maintained for more than five seconds. If full-surface actuation ends between the first and the fifth second, the push button sensor will not send any telegrams. If the status LEDs of the rocker are used as "button-press displays", they will light up for three seconds during transmission of the storage telegram.

- i Full-surface actuation cannot be configured in the push button functions. There it is possible to configure the single-surface principle, which also allows an operating area to be depressed at the centre or over a large area.

4.2.4.1.5 Venetian blind function

For each rocker or each button with the function set to "Venetian blind" the ETS indicates the two 1-bit objects "STEP operation" and "MOVE operation".

The status LEDs can be configured independently (see page 100).

Operation concept for the Venetian blind function

For the control of Venetian blind, roller shutter, awning or similar drives, the push button sensor supports four operation concepts in which the telegrams are transmitted in different time sequences. The push button can therefore be used to operate a wide variety of drive configurations.

The different operation concepts are described in detail in the following chapters.

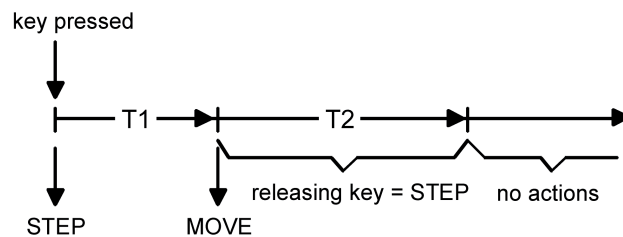

Figure 21: Operation concept "short – long – short"

Operation concept "short – long – short":

In the operation concept "short – long – short", the push button sensor shows the following behaviour:

- Immediately on pressing the button, the push button sensor transmits a short time telegram. Pressing the button stops a running drive and starts time T1 ("time between short time and long time command"). No other telegram will be transmitted, if the key is released within T1. This short time serves the purpose of stopping a continuous movement. The "time between short time and long time command" in the push button sensor should be selected shorter than the short time operation of the actuator to prevent a jerky movement of the blind.
- If the button is kept depressed longer than T1, the push button sensor transmits a long time telegram after the end of T1 for starting up the drive and time T2 ("slat adjusting time") is started.
- If the button is released within the slat adjusting time, the push button sensor sends another short time telegram. This function is used for adjusting the slats of a blind. The function permits stopping the slats in any position during their rotation. The "slat adjusting time" should be chosen as required by the drive for a complete rotation of the slats. If the "slat adjusting time" is selected longer than the complete running time of the drive, a push button function is possible as well. This means that the drive is active only when the button is kept depressed.
- If the button is kept depressed longer than T2, the push button sensor transmits no further telegram. The drive remains on until the end position is reached.

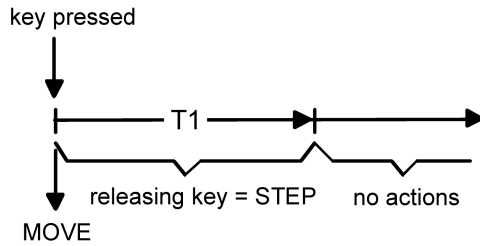

Figure 22: Operation concept "long – short"

Operation concept "long – short":

If the operation concept "long – short" is selected, the push button sensor shows the following behaviour:

- Immediately on pressing the button, the push button sensor transmits a long time telegram. The drive begins to move and time T1 ("slat adjusting time") is started.
- If the button is released within the slat adjusting time, the push button sensor transmits a short time telegram. This function is used for adjusting the slats of a blind. The function permits stopping the slats in any position during their rotation. The "slat adjusting time" should be chosen as required by the drive for a complete rotation of the slats. If the "slat adjusting time" is selected longer than the complete running time of the drive, a push button function is possible as well. This means that the drive is active only when the button is kept depressed.
- If the button is kept depressed longer than T1, the push button sensor transmits no further telegram. The drive remains on until the end position is reached.

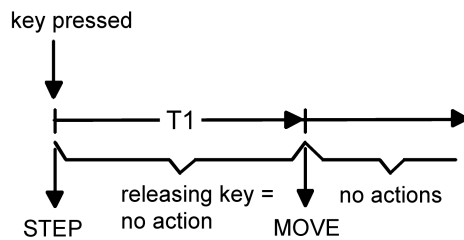

Figure 23: Operation concept "short – long"

Operation concept "short – long":

In the operation concept "short – long", the push button sensor shows the following behaviour:

- Immediately on pressing the button, the push button sensor transmits a short time telegram. Pressing the button stops a running drive and starts time T1 ("time between short time and long time command"). No other telegram will be transmitted, if the key is released within T1. This short time serves the purpose of stopping a continuous movement. The "time between short time and long time command" in the push button sensor should be selected shorter than the short time operation of the actuator to prevent a jerky movement of the blind.
- If the button is kept depressed longer than T1, the push button sensor transmits a long time telegram after the end of T1 for starting the drive.
- No further telegram is transmitted when the button is released. The drive remains on until the end position is reached.

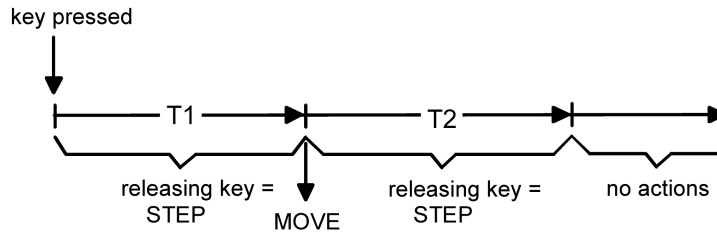

Figure 24: Operation concept "long – short or short"

Operation concept "long – short or short":

In the operation concept "long – short or short", the push button sensor shows the following behaviour:

- Immediately on pressing the button, the push button sensor starts time T1 ("time between short time and long time command") and waits. If the button is released again before T1 has elapsed, the push button sensor transmits a short time telegram. This telegram can be used to stop a running drive. A stationary drive rotates the slats by one level.
 - If the button is kept depressed after T1 has elapsed, the push button sensor transmits a long time telegram and starts time T2 ("slat adjusting time").
 - If the button is released within T2, the push button sensor sends another short time telegram. This function is used for adjusting the slats of a blind. The function permits stopping the slats in any position during their rotation. The "slat adjusting time" should be chosen as required by the drive for a complete rotation of the slats. If the "slat adjusting time" is selected longer than the complete running time of the drive, a push button function is possible as well. This means that the drive is active only when the button is kept depressed.
 - If the button is kept depressed longer than T2, the push button sensor transmits no further telegram. The drive remains on until the end position is reached.
- i** In this operation concept, the push button sensor will not transmit a telegram immediately after depressing one side of the rocker. This principle permits detecting a full-surface operation when the sensor is configured as a rocker.

Single and double-surface Venetian blind function

With an operating area as a rocker, the double-surface Venetian blind function is preset. This means that the push button sensor transmits a telegram for an upward movement, for example after an actuation of the left actuation point and a telegram for a downward movement after an actuation of the right actuation point.

In the separate buttons function, the device is preprogrammed for single-surface Venetian blind function. In this case, the push button sensor alternates between the directions of the long time telegram (TOGGLE) on each long actuation of the sensor. Several short time telegrams in succession have the same direction.

The parameter "Command on pressing the button" or "Command on pressing the rocker" on the parameter pages of the buttons or rockers defines the single-surface or double-surface Venetian blind principle. For the button function, the command issued on pressing the button can basically be selected at the user's discretion.

If the actuator can be controlled from several sensors, a faultless single-surface actuation requires that the long time objects of the push button sensors are interlinked. The push button sensor would otherwise not be able to detect that the actuator has been addressed from another sensor, in which case it would have to be actuated twice during the next use in order to produce the desired reaction.

Full-surface operation with Venetian blind function

When a rocker is configured for Venetian blind operation and if the operation concept "long – short or short" is used, the push button sensor needs some time at the beginning of each operation in order to distinguish between a short and a long operation. When full-surface operation is enabled, the push button sensor can make use of this time span to evaluate the otherwise invalid simultaneous actuation of both actuation points.

The push button sensor detects a full-surface operation of a rocker, if an operating area is depressed over a large area so that both actuation points of the rocker are actuated. When the push button sensor has detected a valid full-surface actuation, the labelling field illumination flashes quickly at a rate of about 8 Hz for the duration of such actuation. Full-surface operation must have been detected before the first telegram has been transmitted by the Venetian blind function (short time or long time). If this is not so, even a full-surface operation will be interpreted as a wrong operation and not be executed.

Full-surface actuation is independent. It has a communication object of its own and can optionally be used for switching (ON, OFF, TOGGLE – toggling of the object value) or for scene recall without or with storage function. In the last case, a press on the full surface causes a scene to be recalled in less than a second. If the push button sensor is to send the telegram for storing a scene, full-surface actuation must be maintained for more than five seconds. If full-surface actuation ends between the first and the fifth second, the push button sensor will not send any telegrams. If the status LEDs of the rocker are used as "button-press displays", they will light up for three seconds during transmission of the storage telegram.

- i Full-surface actuation cannot be configured in the push button functions. There it is possible to configure the single-surface principle, which also allows an operating area to be depressed at the centre or over a large area.

4.2.4.1.6 Value transmitter function

For each rocker or each button with the function set to "1-byte value transmitter" or "2-byte value transmitter", the ETS indicates a corresponding object. On the press of a button, the configured value or the value last stored internally by a value change (see below) will be transmitted to the bus. In case of the rocker function, different values can be configured or varied for both actuation points.

The status LEDs can be configured independently (see page 100).

Value ranges

The "Function" parameter determines the value range used by the push button.

As a 1-byte value transmitter, the push button sensor can optionally transmit integers from 0 ... 255 or relative values within a range of 0 ... 100 % (e.g. as dimming value transmitter).

As a 2-byte value transmitter, the push button sensor can optionally transmit integers from 0 ... 65535, temperature values within a range of 0 ... 40 °C or brightness values from 0 ... 1500 lux. For each of these ranges, the value that can be transmitted to the bus for each actuation of a rocker or button is configurable.

Adjustment by means of long button-press

If the value adjustment feature has been enabled in the ETS, the button must be kept depressed for more than 5 seconds in order to vary the current value of the value transmitter. The value adjustment function continues to be active until the button is released again. In a value adjustment, the push button sensor distinguishes between the following options...

- The "Starting value in case of value adjustment" parameter defines the original starting value for the adjustment. Adjustment can begin from the value configured in the ETS, from the final value of the last adjustment cycle or from the current value of the communication object, with the last option not being available for the temperature and brightness value transmitter.
- The parameter "Direction of value adjustment" defines whether the values will always be increased ("upwards"), always reduced ("downwards") or alternately increased and reduced ("toggling").
- For the value transmitters 0 ... 255, 0 ... 100 % and 0 ... 65535, the "level size" by which the current value is to be changed during the value adjustment can be specified. In case of the temperature and the brightness value transmitter, the level size specifications (1 °C and 50 lux) are fixed.
- The parameter "Time between two telegrams" can be used in connection with the step size to define the time required to cycle through the full respective value range. This value defines the time span between two value transmissions.
- If, during the value adjustment, the push button sensor detects that the preset level size would result in the limits being exceeded with the next telegram, it adapts the level size once in such a way that the respective limit value is transmitted together with last telegram. Depending on the setting of the parameter "Value adjustment with overflow", the push button sensor stops the adjustment at this instance or inserts a pause consisting of two levels and then continues the adjustment beginning with the other limit value.

	Function	Lower numerical limit	Upper numerical limit
1-byte value transmitter	0...255	0	255
1-byte value transmitter	0...100 %	0 % (value = 0)	100 % (value = 255)
2-byte value transmitter	0...65535	0	65535
2-byte value transmitter	Temperature value	0 °C	40 °C
2-byte value transmitter	Brightness value	0 lux	1.500 lux

Table 1: Value range limits for the different value transmitters

- i** During a value adjustment, the newly adjusted values are only in the volatile RAM memory of the push button sensor. Therefore, the stored values are replaced by the preset values programmed in the ETS when a reset of the push button sensor occurs (bus voltage failure or ETS programming).
- i** With the 1-byte value transmitter in the "Value transmitter 0...100 %" function, the level size of the adjustment will also be indicated in "%". If the starting value of the communication object is used, it may happen in this case during value adjustment that the value last received via the object must be rounded and adapted before a new value can be calculated on the basis of the level size and transmitted. Due to the computation procedure used, the new calculation of the value may be slightly inaccurate.

Value adjustment examples

- Value transmitter 1-byte (all other value transmitters identical)
- Function = value transmitter 0...255
- Value configured in the ETS (0...255) = 227
- Level size (1...10) = 5
- Start on value adjustment = same as configured value
- Direction of value adjustment = toggling (alternating)
- Time between two telegrams = 0.5 s

Example 1: Value adjustment with overflow? = No

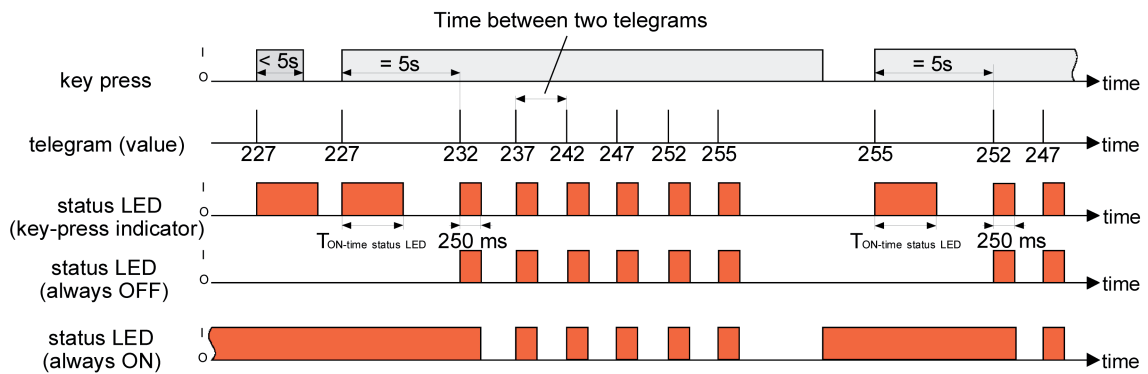

Figure 25: Example of value adjustment without value range overflow

Example 2: Value adjustment with overflow? = Yes

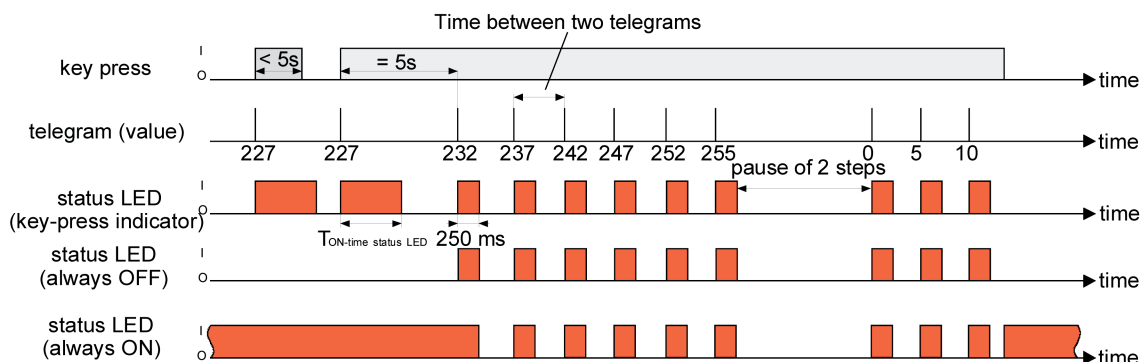

Figure 26: Example of value adjustment with value range overflow

4.2.4.1.7 Scene extension function

For each rocker or button with the function set to "scene extension unit" the ETS indicates the "Function" parameter which distinguishes between the following settings...

- "Scene extension without storage function",
- "Scene extension with storage function",
- "Recall of internal scene without storage function",
- "Recall of internal scene extension with storage function".

In the scene extension function, the push button sensor transmits a preset scene number (1...64) via a separate communication object to the bus after a button-press. This feature permits recalling scenes stored in other devices and also storing them, if the storage function is used.

The recall of an internal scene does not result in a telegram being transmitted to the bus. For this reason, the corresponding communication object is missing. This function can rather be used to recall – and with the storage function also to store – the up to 8 scenes stored internally in the push button sensor.

In the setting "... without storage function", a button-press triggers the simple recall of a scene. If the status LED is configured as button-press display, it will be switched on for the configured ON time. A long button-press has no further or additional effect.

In the setting "... with storage function", the push button sensor monitors the length of the actuation. A button-press of less than a second results in a simple recall of the scene as mentioned above. If the status LED is configured as button-press display, it will be switched on for the configured ON time.

After a button-press of more than five seconds, the push button sensor generates a storage instruction. In the scene extension function, a storage telegram is in this case transmitted to the bus. If configured for the recall of an internal scene, the sensor will store the internal scene. The internal scene control module will then request the current scene values for the actuator groups used from the bus (see page 178).

An operation lasting between one and five seconds will be discarded as invalid.

The parameter "Scene number" specifies which of the maximum of 8 internal or 64 external scenes is to be used after a button-press. In case of the rocker function, two different scene numbers can be assigned.

The status LEDs can be configured independently (see page 100).

4.2.4.1.8 2-channel operation function

In some situations it is desirable to control two different functions with a single button-press and to transmit different telegrams, i.e. to operate two function channels at a time. This is possible with the "2-channel operation" function.

For both channels, the parameters "Function channel 1" and "Function channel 2" can be used to determine the communication object types to be used. The following types are available for selection...

- Switching (1 bit)
- Value transmitter 0 ... 255 (1-byte)
- Value transmitter 0 ... 100 % (1-byte)
- Temperature value transmitter (2 bytes)

The object value the push button sensor is to transmit on a button-press can be selected depending on the selected object type. The "Switching (1 bit)" type permits selecting whether an ON or an OFF telegram is to be transmitted or whether the object value is to be switched over (TOGGLE) and transmitted on the press of a button.

The configuration as "Value transmitter 0 ... 255 (1 byte)" or as "Value transmitter 0 ... 100 % (1 byte)" permits entering the object value freely within a range from 0 to 255 or from 0% to 100%. The "Temperature value transmitter (2 bytes)" permits selecting a temperature value between 0°C and 40°C.

In this case, the adjustment of the object value on a long button-press is not possible as the determination of the actuation length is needed for the adjustable operation concepts. Unlike in the other rocker and button functions, the application software assigns the "Telegram acknowledge" function instead of the "Button-press display" function to the status LED. In this mode, the status LED lights up for approx. 250 ms with each telegram transmitted. Alternatively, the status LEDs can be configured independently (see page 100).

Operation concept channel 1 or channel 2

In this operation concept, exactly one telegram will be transmitted on each press of a button.

- On a brief press the push button sensor transmits the telegram for channel 1.
- On a long press the push button sensor transmits the telegram for channel 2.

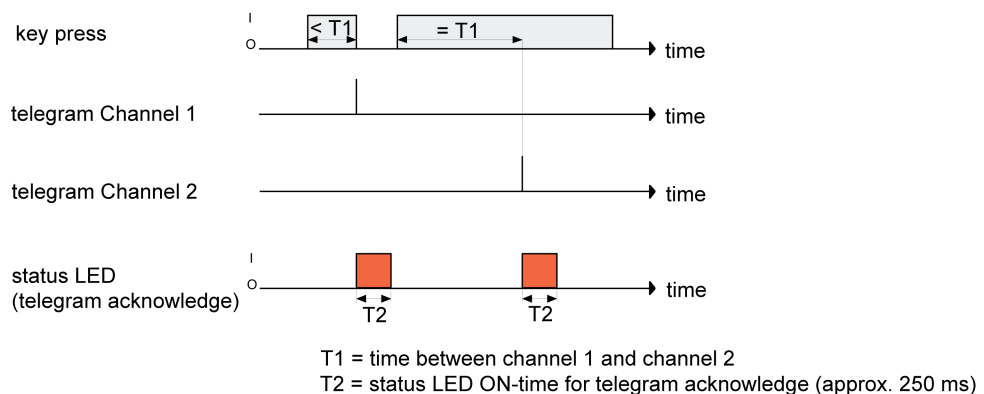

Figure 27: Example of operation concept "Channel 1 or Channel 2"

The time required for distinguishing between a short and a long operation is defined by the parameter "Time between channel 1 and channel 2". If the button is pressed for less than the configured time, only the telegram to channel 1 is transmitted. If the length of the button-press exceeds the time between channel 1 and channel 2, only the telegram to channel 2 will be transmitted. This concept provides the transmission of only one channel. To indicate that a telegram has been transmitted, the status LED lights up for approx. 250 ms in the "Telegram

acknowledge" setting.

In this operation concept, the push button sensor will not transmit a telegram immediately after the rocker has been depressed. This principle also permits the detection of full-surface operation. The settings that are possible with full-surface operation are described below.

Operation concept channel 1 and channel 2

With this operation concept, one or alternatively two telegrams can be transmitted on each button-press.

- On a brief press the push button sensor transmits the telegram for channel 1.
- A long press causes the push button sensor to transmit first the telegram for channel 1 and then the telegram for channel 2.

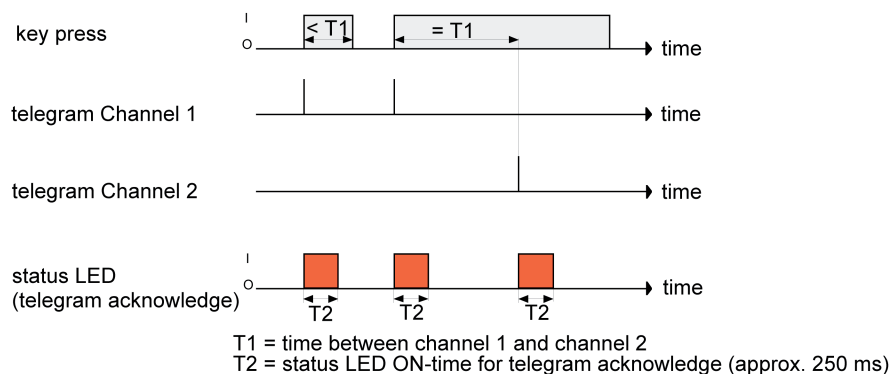

Figure 28: Example for operation concept "Channel 1 and channel 2"

The time required for distinguishing between a short and a long operation is defined by the parameter "Time between channel 1 and channel 2". In this operation concept, a button-press sends this telegram immediately to channel 1. If the button is held depressed for the configured time, the telegram for the second channel is transmitted as well. If the button is released before the time has elapsed, no further telegram will be transmitted. This operation concept, too, offers the configurable possibility of having the transmission of a telegram signalled by the status LED (setting "Telegram acknowledge").

Full-surface operation with 2-channel operation

When a rocker is programmed for 2-channel operation and if the operation concept "channel 1 or channel 2" is used, the push button sensor needs some time at the beginning of each operation in order to distinguish between a short and a long operation. When full-surface operation is enabled, the push button sensor can make use of this time span to evaluate the otherwise invalid simultaneous actuation of both actuation points.

The push button sensor detects a full-surface operation of a rocker, if an operating area is depressed over a large area so that both actuation points of the rocker are actuated. When the push button sensor has detected a valid full-surface actuation, the labelling field illumination flashes quickly at a rate of about 8 Hz for the duration of such actuation. The full-surface operation must have been detected before the first telegram has been transmitted by the 2-channel function. If this is not so, even a full-surface operation will be interpreted as a wrong operation and not be executed.

4.2.4.1.9 Controller extension function

The controller extension can be used to control a KNX/EIB room temperature controller. Typical KNX/EIB room temperature controllers generally offer different ways of influencing the room temperature control...

- Operating mode switch:
Switching over between different modes of operation (e.g. "Comfort", "Night" ...) with different setpoint temperatures assigned to each mode by the controller
- Presence status:
Signalling the presence of a person in a room. The signalling may also be combined with a configured switchover in the mode of operation.
- Setpoint shift:
Readjustment of the setpoint temperature in steps which are referred in each case to the configured setpoint temperature of the current mode of operation.

The controller extension is operated using the push button functions of the device. In this way, it is possible to completely control a room temperature controller by changing the operating mode, by predefining the presence situation or by readjusting the setpoint shift. For this purpose, the buttons of the push button sensor selected as extension operation buttons must be configured for the "Controller extension" function.

For further information, see the "Controller extension" chapter (see page 166-167).

- i** It should be noted that an extension operation is possible with a button configuration. The controller extension function must be enabled in the "Room temperature controller" parameter node.

4.2.4.1.10 Controller operation function

The "Controller operation" push button function can be used to control the internal room temperature controller. The room temperature controller of the push button sensor 3 plus offers different ways of influencing the room temperature control...

- Operating mode switch:
Switching over between different modes of operation (e.g. "Comfort", "Night" ...) with different setpoint temperatures assigned to each mode by the thermostat.
- Presence status:
Signalling the presence of a person in a room. The signalling may also be combined with a configured switchover in the mode of operation. Pressing a button switches over the presence status. This push button function may only be used if the presence detection is configured to "Presence button" on the "Controller functionality" parameter page.
- Setpoint shift:
Readjustment of the setpoint temperature in steps which are referred in each case to the configured setpoint temperature of the current mode of operation. A setpoint shift is only possible if the controller is configured in the ETS to relative temperature setpoints (derivation from basic setpoint) (see page 136)! With absolute setpoint temperature presetting the push button sensor does not execute the "Setpoint shift" push button function.

i It should be noted that controller operation is only possible with a button configuration. The controller function must be switched on in the "Room temperature control" parameter node.

4.2.4.1.11 Heating timer operation function

Heating timer operation facilitates demand-driven activation or deactivation of the heating timer integrated in the device. The heating timer implements the automatic switchover of the controller operating mode depending on the time of day and the day of the week. For this purpose, the device provides up to 28 separate switching times that can be preconfigured individually in the ETS (see page 163-164), and can be modified subsequently via the settings menu while the push button sensor is in operation (see page 26).

Pressing a button configured as "Heating timer operation" switches over the state of the heating timer (activated <-> deactivated). The status LED of the button can indicate the state of the push button function.

It should be noted that the heating timer operation is only effective if the function has been enabled globally on the "Room temperature control -> Heating timer" parameter page. Only then is an additional parameter for the push button function visible.

i The "Heating timer operation" function cannot be configured for a rocker function.

4.2.4.1.12 Manual fan control function

The manual fan control makes it possible to control the fan of a fan coil, independent of the command value specification of a room temperature controller. This enables requirements-oriented ventilation of a room in any desired, manually specified fan level. With the push button sensor 3 plus, manual control of the fan is possible via a rocker switch or push button function and also via the configuration menu.

The fan controller distinguishes between Automatic and Manual operation. Manual operation and thus also the switchover of the fan operating mode is possible by pressing a button on the device. For this, a rocker switch or button must be configured to the function "Manual fan control".

It should be noted that the manual fan control is only effective if the function has been enabled globally on the "Display" parameter page. Only then are further parameters for the rocker switch or push button functions visible. If the function is enabled globally, then the device display can - depending on the parameterised display function - show the current fan level and the fan operating mode (see page 195-196).

- i** To allow fan control and also indication of the current fan level, various communication objects have to be linked with the actuator of the fan coil. Furthermore, various parameters of the actuator have to be set to manual fan control via the push button sensor in the actuator's ETS application program (see page 192).

With manual fan control via rocker switches or buttons a distinction is made whether automatic mode or manual operation of the fan coil is active when the button is pressed.

With activated automatic mode:

The display shows "**Auto**" and the active fan level. Pressing a button with the function "Increase fan level" first automatically activated manual operation. The automatic functions of the fan controller are then deactivated. The display shows "**Manu**" and the active fan level. It is now possible by pressing a button with the function "Increase fan level" to switch the fan level up manually step by step until the maximum level is reached. Pressing a button with the function "Reduce fan level" switches the fan level down step by step to "0" (fan OFF). Pressing a button with the function "Reduce fan level" again in the "OFF" state deactivates the manual fan control and activates the automatic mode again. The display then shows "**Auto**".

When manual operation is activated:

The display shows "**Manu**" and the active fan level of the manual control. It is now possible by pressing a button with the function "Increase fan level" to switch the fan level up manually step by step until the maximum level is reached. Pressing a button with the function "Reduce fan level" switches the fan level down step by step to "0" (fan OFF). Pressing a button with the function "Reduce fan level" again in the "OFF" state deactivates the manual fan control and activates the automatic mode again. The display then shows "**Auto**" and the active fan level of the automatic mode.

4.2.4.1.13 Status LED

Basic function

Each control surface on the push button sensor has two status LEDs. The parameters "Function of the left status LED" and "Function of the right status LED" on the parameter pages "Button x - Status LED" or "Rocker x - Status LED" define the basic functions of these status indicators. Depending on the configuration of the rockers or buttons, the possible LED functions available differ slightly. The display parameters "Possible LED functions" on the parameter pages of the status LEDs show the specific LED functions that can be configured. If LED functions other than the possible ones are configured, the affected status LEDs will not have any function during subsequent operation of the push button sensor (always OFF).

- i** The parameter pages of the status LEDs are subordinated to the rocker switches or buttons, and each of them contains the status LEDs assigned to the rocker switches or buttons (for buttons only one LED each / for rocker switches two LEDs each).

The following LED functions are available for selection in the configuration...

- "always OFF"
This setting can be selected for every rocker switch/push button function.
- "always ON"
This setting can be selected for every rocker switch/push button function.
- "button-press display"
This setting cannot be selected for the rocker switch/push button functions "No function" and "2-channel operation".
- "telegram acknowledgment"
This setting can only be selected for the rocker switch/push button function "2-channel operation".
- "status display (switching object)"
This setting can only be selected for the rocker switch/push button functions "Switching" and "Dimming".
- "inverted status display (switching object)"
This setting can only be selected for the rocker switch/push button functions "Switching" and "Dimming".
- "activation via separate LED object"
This setting can be selected for every rocker switch/push button function.
- "operating mode display (KNX controller)"
This setting can be selected for every rocker switch/push button function.
- "Controller status display"
This setting can be selected for every rocker switch/push button function.
- "Setpoint value shift display"
This setting can only be selected for the push button functions "Controller extension - setpoint shifting" or "Controller operation - setpoint shifting".
- "Button function active display"
This setting can only be selected for the push button functions "Controller extension - presence button", "Controller operation - presence button", "Controller operation - operating mode switchover" or "Heating timer operation".
- "Button function inactive display"
This setting can only be selected for the push button functions "Controller extension - presence button", "Controller operation - presence button", "Controller operation - operating mode switchover" or "Heating timer operation".
- "comparator without sign (1 byte)"
This setting can be selected for every rocker switch/push button function.
- "comparator with sign (1 byte)"
This setting can be selected for every rocker switch/push button function.

- i** Besides the functions that can be set separately for each status LED, all status LEDs are also used for alarm signalling. If this is active, all LEDs of the push button sensor flash simultaneously. After deactivation of the alarm signalling, all LEDs will immediately return to the state corresponding to their configuration and communication objects.

Status LED function "always OFF" or "always ON":

The corresponding status LED is always switched off or always switched on depending on the parameter setting.

Function of the status LED "Button-press display" or "Telegram acknowledgement":

A status LED used as button-press display is switched on by the sensor each time the corresponding rocker or button is pressed. The parameter "ON time of status LEDs as actuation indicators" on the parameter page "General" specifies for how long the LED is switched on in common for all status LEDs. The status LED lights up when the rocker or button is pressed even if the telegram is transmitted by the sensor only when the button or rocker is released. With the function "2-channel operation" the option "Button-press display" is replaced by "Telegram acknowledge". In this case the status LED is illuminated when both channels are transmitted for about 250 ms each.

Function of the status LED "status display", "inverted status display" and "activation via separate LED object":

The status LEDs can be linked in the rocker or button functions "switching" and "dimming" also with the object used for switching and thus signal the current switching state of the actuator group.

Alternatively each status LED can indicate the state of a separate LED communication object. Here the LED can be switched on or off statically via the 1-bit object value received, or also activated as flashing. If multiple status LEDs are configured to "flashing" and switched on, they will flash synchronously.

Both for the status indication of the LED object and also for the status indication of the switching object it is possible to indicate or evaluate the inverted object value.

After a bus reset or after ETS programming, the value of the LED object is always "OFF".

Function of status LED as "operating mode display (KNX controller)":

In this configuration the status LED has its own 1-byte communication object.

For switching over between different modes of operation, new room temperature controller can make use of two communication objects of the 20.102 "HVAC-Mode" data type. One of these objects can switch over with normal priority between the "Comfort", "Standby", "Night", "Frost/heat protection" operating modes. The second object has a higher priority. It permits switching over between "Automatic", "Comfort", "Standby", "Night", "Frost/heat protection". Automatic means in this case that the object with the lower priority is active.

If a status LED is to indicate the operating mode, the communication object of the status LED must be linked with the matching object of a room temperature controller (e. g. Controller status). The desired operating mode which the LED is to indicate can then be selected with the parameter "Status LED on with". The LED is then lit up when the corresponding operating mode has been activated at the controller.

After a bus reset or after ETS programming, the value of the LED object is always "0" (Automatic).

Function of status LED as "controller status display":

If a status LED is to indicate the status of a room temperature controller in the configuration "Controller status display", the main controller or the controller extension must have been activated on parameter page "Room temperature control". The status LED is then connected internally directly with the "Controller status" object, or, in the case of a KNX-compliant controller status, with the "KNX status" and "KNX status operating mode" objects. For controller extensions these objects should be connected via group addresses to the communication

objects of the main controller with the same functions.

The status objects combine different informations. The "Status LED on with" parameter must be selected, whose information should be evaluated and displayed via the status LED.

The following can be selected...

- Comfort mode
- Standby mode
- Night mode
- Frost / heat protection
- Controller disabled
- Heating / cooling (Heating = 1 / Cooling = 0)
- Controller inactive *
- Frost alarm *

*: These settings do not have any function for a KNX-compliant controller status, because the information is not available. The status-LED is then always off.

Description of the status messages of the room temperature controller (active = ON):

Comfort mode: Active if operating mode "Comfort" or a comfort extension is activated.

Standby mode: Active if the "Standby" operating mode is activated.

Night mode: Active if the "Night" operating mode is activated.

Frost/heat protection: Active if the "Frost/heat protection" operating mode is activated.

Controller disabled: Active if controller disable is activated (dew point mode).

Heating/cooling: Active if heating is activated and inactive if cooling is activated. (As a rule inactive with controller disabled.)

Controller inactive: Active with the "heating and cooling" operating mode when the measured room temperature lies within the dead zone. This status information is as a rule always "0" for the individual operating modes "heating" or "cooling"! (Inactive if controller is disabled.)

Frost alarm: Active if the measured room temperature reaches or drops below + 5 °C.

Function of the status LEDs "Setpoint value shift display", "Button function active display" and "Button function inactive display":

When a setpoint shift is displayed, for controller extensions the LED evaluates the value of the "Controller extension - Current setpoint shift" object and switches on or off depending on the parameter configuration in the ETS. With this LED configuration, as soon as the room temperature controller integrated in the push button sensor is switched on the state of the internal setpoint shift is immediately evaluated and displayed.

When a push button function is displayed, the LED can evaluate the controller presence state or the operating mode (for the "Controller operation" push button function). For presence mode, with controller extensions the state of the "B.Controller extension presence button" object is evaluated and displayed (presence mode on = LED on / presence mode off = LED off). With main controllers, the LED derives the state directly from the internal controller.

In this LED configuration, display of the controller operating mode is only possible for main controllers. The display information is then taken directly from the internal controller core. Display of an active or inactive push button function can also be configured for heating timer operation. In this case, for main controllers the LED shows the state of the heating timer integrated in the push button sensor (active, inactive). For controller extensions the heating timer is always inactive (the LED is OFF in this configuration).

- i** The communication objects ("B.Controller extension", "D.Input controller extension") of the controller extension update themselves automatically after a reset of the push button sensor, if the parameter "Value request from controller extension?" on the "Room temperature control" parameter page is set to "Yes". Updating is effected by means of a value read telegram to the room temperature controller. The thermostat must answer the request with a value return telegram. If the push button sensor does not receive the answer, the status LED remains off (object value "0"). In this case, the object must first be actively rewritten by the bus after a reset before a status information can be indicated by the LED.
This is also the case, when the "Value request from controller extension?" is set to "No".

Function of status LED as "comparator":

The status LED can indicate whether a configured comparison value is greater than, equal to or less than the 1-byte object value of the status object. This comparator can be used for unsigned (0 ... 255) or for signed integers (-128 ... 127). The data format of the comparison is defined by the function of the status LED.

The status LED lights up only if the comparison is "true".

- i** After a bus reset or after ETS programming, the value of the LED object is always "0".

Colour setting and superposed function

With the push button sensor 3 plus the colours of the status LEDs can be adjusted. The colours red, green or blue can be selected in the ETS. In the colour configuration a distinction is made between whether all of the status LEDs of the push button sensor have the same colour (common colour setting), or whether alternatively various colours can be configured for the LEDs (separate colour setting). The difference is as follows...

- All status LEDs have the same colour.
If common colour setting is desired, then the parameter "Colour selection of all status LEDs" on parameter page "General" must be configured to the settings "red", "green" or "blue". The status LEDs light up later during operation of the push button sensor unchangeably in the configured colour, if they are switched on.
- The status LEDs have various colours.
If separate colour setting is desired, then the parameter "Colour selection of all status LEDs" on parameter page "General" must be configured to the setting "Colour selection per rocker switch/button". In this case additional parameters become visible on the parameter pages of the individual status LEDs. The parameters "Colour of the status LED" can then be used individually to define the desired colour for each status LED. The LED lights up in the configured colour if it is subsequently switched on regularly in operation of the push button sensor in accordance with the basic configuration "Function of the status LED".

In addition, with separate colour setting it is possible to configure a superposed function separately for each status LED. The superposed function can be used change the colour of a status LED via a communication object during operation of the device. It is also possible here to change the display function. The superposed function of a status LED is enabled when the parameter with the same name is configured to "enabled" on the corresponding parameter page.

When a superposed function is enabled, additional parameters and a communication object become visible in the ETS. It is thus possible to configure which colour the status LED should have when a superposed function is active, and which display function is then executed. The parameter "Selection of the superposed LED function" defines the display function, and thus the data format of the object. The following selections are available: "Activation via separate LED object" (1-bit) or alternatively "Comparator without / with sign" (1-byte). The fundamental function of these superposed display functions is the same as the functions of the basic display of a status LED (see page 100).

In accordance with the selection of the display function and the parameter configuration resulting from it, the superposed function can be switched on or off via the 1-bit or 1-byte object. The status LED will only light up in the superposed colour when a function is switched on. When a superposed function is switched off the status LED will be activated according to its basic configuration (regular colour and display function).

- i** The superposed function is initially always inactive after a device reset. The superposed function is only executed when a telegram is received via the corresponding object.
- i** Regardless of the basic configuration of the status LED and the superposed function, the LEDs always flash red when a display alarm message is active. An alarm message has a higher priority and thus overrides the basic display and the superposed function. After deactivation of the alarm signalling, all LEDs will immediately return to the state corresponding to their configuration and communication objects.
- i** During colour configuration it must be ensured that different colours are configured for the basic display and the superposed function. If this is not done (the colours are the same), then when the display is static it is not possible to determine which display function is being indicated.

- i When the superposed function is activated via a 1-bit object it is possible to have the status LED flash in the superposed colour. During flashing the status LED switches cyclically between the "switched-on" and "switched-off" states. No colour change is performed between the regular colour and the superposed colour.

4.2.4.1.14 Brightness setting

The brightness of all status LEDs, the labelling field illumination and the LCD backlighting of the push button sensor can be defined in the ETS. The parameter "Brightness for all LEDs" on the parameter page "General" can be used to set the regular illumination brightness of all LEDs in 6 levels (level 0 = OFF, level 1 = dark, etc. Level 5 = bright).

Optionally the brightness can be changed during operation of the push button sensor, controlled by a 1-bit communication object. Changing may be advisable, for example, to reduce the brightness during nighttime hours. If switchover of the brightness via the object is required, then it is necessary to set the parameter "Night reduction for reduced brightness ?" on the parameter page "General" to "Yes". In this case the communication object "LED night reduction" becomes visible in the ETS. As soon as a "1" telegram is received via this object, the push button sensor redirects to the "Brightness for all LEDs during night reduction" configured in the ETS. If a "0" telegram is received via the object, the push button sensor redirects back to the regular brightness.

The switchover of the LED brightness is always performed softly by means of a brief dimming process. Dimming up to a higher level value results in quicker dimming than with dimming to a lower level value. This results in a slow soft dimming that is pleasing for the human eye. The dimming speeds are fixed and therefore not changeable.

If in the event of an active night reduction there is a change of state in the display function of any desired status LED, of the labelling field illumination or of the LCD backlighting (e.g. ON after OFF), then all switched-on LEDs of the push button sensor are switched on with the regular brightness for a duration of 30 seconds. In this manner it is possible in night operation, especially with heavily reduced brightness values or even with switched-off LEDs, to identify status changes more easily or in any case.

- i** In the ETS it is possible to perform configuration in accordance with the possible selection of required stage values for the regular and reduced brightness. No check is made whether a reduced brightness level is configured for the reduced brightness level. This also makes it possible to use the object to switch over the object to larger brightness levels in comparison to the regular brightness. It is recommended, however, to set the brightness value for the night reduction lower than the regular brightness.
- i** After a device reset the regular brightness for switched-on LEDs is always valid. A switchover via the night reduction only takes place if the corresponding object is written by a telegram after a reset.
- i** When the status LED is activated via the regular display function or via the superposed function, it is possible to let the status LED flash. The same applies for the labelling field illumination. During flashing the LEDs switch synchronously between the "switched-on" and "switched-off" states in the active brightness. This is not interpreted as a change of state of the display function, by means of which the brightness is therefore also not switched over automatically.
- i** When a display alarm message is active the status LEDs, the labelling field illumination and the LCD backlighting of the push button sensor always flash with the regular brightness. The push button sensor automatically deactivates the night reduction for the duration of the display alarm message, and tracks it again, when the alarm message is switched off and the object for the night reduction is still "1"-active.

4.2.4.1.15 Disabling function

Configuration

With the 1-bit communication object "Disable buttons", the control surfaces of the push button sensor can be partly or completely disabled. During a disable, the rockers or buttons can also temporarily execute other functions.

An active disable applies only to the functions of the rockers or buttons. The functions of the status LED, scene function and the alarm signalling are not affected by the disabling function. The disabling function and the pertaining parameters and communication objects are enabled if the parameter "Disabling function ?" is set to "Yes" on the "Disabling" parameter page.

You can parameterize the polarity of the disabling object. In case of polarity inversion (disabled = 0 / enabled = 1), the disabling function is not activated immediately after a bus reset or after ETS programming (object value = "0"). There must first be an object update "0" until the disabling function will be activated. Telegram updates from "0" to "0" or from "1" to "1" on the "B.button disabling" object remain without effect.

During an active push button sensor disable function, the symbol  is lit up on the display of the device.

Configuring the reaction during a disable

In an active disable, either all buttons of the device including the display buttons or only individual buttons may be affected by the disable. Moreover, it is possible to set in the ETS whether disabled buttons have no response when pressed, or alternatively whether they respond like a different button of the device. This can be used to limit the control function of the push button sensor completely or partially.

The disabling function must have been enabled in advance.

- Set the parameter "Button assignment of the buttons for disabling function" to "All buttons assigned"
The disabling function affects all buttons. As soon as any button of the device is pressed while a disabling function is active, the push button sensor executes the "behaviour when a disabling function is active".
In this configuration the display buttons are also disabled if the parameter "Behaviour when a disabling function is active" is set to "No response when pressed" (see below). Otherwise the display buttons are not disabled.
- Set the parameter "Button assignment of the buttons for disabling function" to "Individual buttons assigned"
The disabling function affects only the buttons that are assigned on the "Disable - Button selection" parameter page. As soon as one of the assigned buttons is pressed while a disabling function is active, the "Behaviour when a disabling function is active" for this button is executed. All other, non-disabled buttons respond normally when pressed.
- Set the parameter "Behaviour when a disabling function is active" to "No response when pressed".
The disabled buttons do not respond when pressed. The status LEDs of the disabled buttons remain off if the display function is configured to "Button-press display" or "Telegram acknowledgement".
- Set the parameter "Behaviour when a disabling function is active" to "No response when pressed like...". Also configure the parameters "All assigned right buttons behave like" and "All assigned left buttons behave like" to the required button number or disabling function as a reference button.

All buttons assigned to the disabling function behave as defined in the parameters for the two specified reference buttons of the push button sensor. Different or identical reference buttons can be configured separately for all the left and right operating buttons. The two "virtual" disabling functions of the push button sensor can also be configured as a reference button.

The telegrams are transmitted to the bus via the communication objects of the specified reference buttons. The status LEDs of the reference buttons are controlled according to their function. The status LEDs of the disabled buttons remain off if the display function is configured to "Button-press display" or "Telegram acknowledgement".

- i If a button evaluation is taking place at the time of activation / deactivation of a disabling function, this function is aborted immediately and with it also the pertaining button function. It is first necessary to release all buttons before a new button function can be executed if so permitted by the state of disabling.
- i It should be noted that buttons that are configured to "Controller operation" can be disabled independently of the push button sensor disabling function, if the controller operation is disabled (see page 162). The same applies for the display buttons.

4.2.4.1.16 Alarm signalling

Alarm signal display

The push button sensor permits signalling of an alarm which might be, for instance, a burglar or a fire alarm from a KNX/EIB central alarm unit. An alarm is signalled by all status LEDs, the labelling field illumination and the LCD backlighting of the push button sensor flashing synchronously. This alarm indication can be separately enabled with the parameter "Alarm message indication" on parameter page "Alarm messages" so that it can be used.

When alarm signalling is enabled, the ETS displays the communication object "Alarm signalling" and further alarm function parameters.

The alarm signalling object is used as an input for activating or deactivating alarm signal displaying. The polarity of the object can be selected. When the object value corresponds to the "Alarm" condition, all status LEDs, the labelling field illumination and the LCD backlighting are always flashing with a frequency of approx. 2 Hz. If there is an alarm, the behaviour of the labelling field illumination as configured in the ETS, the status LED and the LCD backlighting for normal operation have no significance. The LEDs adopt their originally configured behaviour only after the alarm signalling function has been deactivated. Changes of the state of the LEDs during an alarm - if they are controlled by separate LED objects or if they signal push button functions - are internally stored and recovered at the end of the alarm.

- i** Regardless of the colour configuration of the status LED in normal operation and with a superposed function, the LEDs always flash red when a display alarm message is active.
- i** When a display alarm message is active the status LEDs, the labelling field illumination and the LCD backlighting of the push button sensor always flash with the regular brightness. The push button sensor automatically deactivates the night reduction for the duration of the display alarm message, and tracks it again, when the alarm message is switched off and the object for the night reduction is still "1"-active.

Apart from the possibility of deactivating an alarm signal via the alarm object, it can also be deactivated locally by a button-press on the push button sensor itself. The "Reset alarm signalling by a button-press?" parameter defines the button response during an alarm...

- If this parameter is set to "Yes", active alarm signal displaying can be deactivated by a button-press on the push button sensor. This button-press does not cause the configured function of the pressed button to be executed. Only after the next button-press will the configuration of the button be evaluated and a telegram be transmitted to the bus, if applicable.
- If "No" has been selected, alarm signalling can only be deactivated via the alarm signalling object. A button-press will always directly execute the configured button function.

If alarm signalling can be deactivated by a button-press, the parameter "Acknowledge alarm signalling by" defines whether an additional alarm acknowledge telegram is to be transmitted to the bus via the separate object "Alarm signalling acknowledge" after triggering by this button-press.

Such an acknowledge telegram can, for instance, be sent via a 'listening' group address to the "Alarm signalling" objects of other push button sensors in order to reset the alarm status there as well. Attention must be paid during resetting of an alarm to the selectable polarity of the acknowledge object.

- i** Notes on the polarity of the alarm object: If the setting is "Alarm when OFF and alarm reset when ON", the alarm object must be actively written by the bus with "0" to activate the alarm after a reset or after programming with the ETS.

- i** An active alarm message is not stored so that the alarm indication is generally deactivated after a device reset or after programming with the ETS.

4.2.4.2 Room temperature controller

The device can be used for single-room temperature control. Depending on the operating mode, the current temperature setpoint and on the room temperature, command values for heating or cooling control and fan control can be sent to the KNX/EIB. Usually, these command values are then converted by a suitable KNX/EIB actuator, e.g. heating or switching actuators or directly by bus-compatible actuating drives, evaluated and converted to physical variables for air conditioning control.

The room temperature control is an independent function section of the device. It has its own parameter and object range in the ETS configuration. Therefore, the room temperature controller can be switched on or off, irrespective of the push button sensor function. The controller function section of the device can either work as a main controller or as a controller extension. As the main controller, the room temperature controller function is fully switched on and the control algorithm activated. Only the main controller transmits control value telegrams. A controller extension itself is not involved in the temperature regulating process. With it, the user can operate the single-room controller, i.e. the main controller from different places in the room. In this way, any number of operating extensions can be set up.

In this chapter, the functions of the room temperature controller are described as a main controller.

4.2.4.2.1 Operating modes and operating mode change-over

Introduction

The room temperature controller distinguishes between two different operating modes. The operating modes specify whether you want the controller to use its variable to trigger heating systems ("heating" single operating mode) or cooling systems ("cooling" single operating mode). You can also activate mixed operation, with the controller being capable of changing over between "Heating" and "Cooling" either automatically or, alternatively, controlled by a communication object.

In addition, you can establish two-level control operation to control an additional heating or cooling unit. For two-level feedback control, separate command values will be calculated as a function of the temperature deviation between the setpoint and the actual value and transmitted to the bus for the basic and additional levels. The parameter "Controller operating mode" in the "Room temperature control -> Controller general" parameter branch specifies the operating mode and, if necessary, enables the additional level(s).

- i** The "heating and cooling" mixed-mode and the two-level controlled operation are not available when using two control circuits! In this case only the "heating or cooling single operating modes are configurable.

"Heating" or "cooling" single operating modes

In the single "Heating" or "Cooling" operating modes without any additional level, the controller will always work with one command value and, alternatively, when the additional level is enabled, it will use two command value in the configured operating mode. Depending on the room temperature determined and on the specified setpoint temperatures of the operating modes, the room temperature controller will automatically decide whether heating or cooling energy is required and calculates the command value for the heating or cooling system.

"Heating and cooling" mixed operating mode

In the "Heating and cooling" mixed operating mode, the controller is capable of triggering heating and cooling systems. In this connection, you can set the change-over behaviour of the operating modes...

- "Change over between heating and cooling" parameter in the "Room temperature control -> Controller general -> Setpoints" parameter branch set to "Automatic".

In this case, a heating or cooling mode will be automatically activated, depending on the room temperature determined and on the given temperature basic setpoint, or on the deadband, respectively. If the room temperature is within the preset deadband neither heating nor cooling will take place (both command values = "0"). In this connection, the display will read the heating temperature setpoint of the activated operating mode when you actuate the display buttons ("Setpoint" menu). If the room temperature is higher than the cooling temperature setpoint cooling will take place. If the room temperature is lower than the cooling temperature setpoint heating will take place.

When the heating/cooling operating mode is switched over automatically, the information can be actively output to the bus via the object "Heating/cooling switchover" to indicate whether the controller is working in the heating mode ("1" telegram) or in the cooling mode ("0" telegram). In this connection, the "Automatic heating/cooling change-over transmission" parameter specifies when an operating mode change-over will be transmitted...

- Setting "On changing the operating mode": In this case, a telegram will be transmitted solely on switchover from heating to cooling (object value = "0") or from cooling to heating (object value = "1"), respectively.

- Setting "On changing the output command value": with this setting, the current operating mode will be transmitted whenever there is a modification of the output command value. If the variable = "0" the operating mode which was active last will be transmitted. If the room temperature determined is within the dead band the operating mode activated last will be retained in the object until a switch-over into the other operating mode takes place, if necessary. In addition, the object value can be output in cycles when automatic switch-over is being made.

The "Cyclical transmission heating/cooling change-over" parameter enables cyclic transmission (factor > "0" setting) and specifies the cycle time.

With an automatic operating mode change-over, it should be noted that under certain circumstances there will be continuous change-over between heating and cooling if the deadband is too small. For this reason, you should, if possible, not set the deadband (temperature difference between the setpoint temperatures for the comfort heating and cooling modes) below the default value (2 K).

- "Change-over between heating and cooling" parameter in the "Room temperature control -> Controller general -> Setpoints" parameter branch set to "Via object".
In this case, the operating mode is controlled via the object "Heating/cooling switchover", irrespective of the deadband. This type of change-over can, for example, become necessary if both heating and cooling should be carried out through a one-pipe system (heating and cooling system). For this, the temperature of the medium in the single-pipe system must be changed via the system control. Afterwards the heating/cooling operating mode is set via the object (often the single-pipe system uses cold water for cooling during the summer, hot water for heating during the winter).
The "Heating/cooling change-over" object has the following polarities: "1": heating; "0" cooling. After a reset, the object value will be "0", and the "Heating/cooling operating mode change-over after reset" set in the ETS will be activated. You can use the "Heating/cooling operating mode after reset" parameter to set which mode you want to activate after a reset. For the "Heating" or "Cooling" settings, the controller will activate the configured heating/cooling operating mode immediately after the initialisation phase. In case of parameterisation "Operating mode before reset" the operating mode which was selected before the reset will be activated.
If a switchover is made through the operating mode object, the operating mode will first be changed into the one specified after a reset. A change-over to the other operating mode will only take place after the device receives an object update, if necessary.
Notes on the setting "Operating mode before reset": frequent changing of the operating mode (e. g. several times a day) during running operation can adversely affect the life of the device as the read-only memory (EEPROM) used has been designed for less frequent write access events only.



- i** Temperature setpoints can be preset for each operating mode in the ETS as part of first configuration. It is possible to configure the setpoints for the "Comfort", "Standby" and "Night" modes directly (absolute setpoint presetting) or relatively (derivation from basic setpoint). With absolute setpoint presetting there is no basic setpoint and also no deadband in the mixed operating mode "Heating and cooling" (if necessary also with additional level). Consequently, the room temperature controller cannot control the switchover of the operating mode automatically, which is why, in this configuration, the setting for the parameter "Switchover between heating and cooling" is fixed in the ETS to "Via object".

It is not possible to heat and cool at the same time (command value > "0"). Only for PWM, a short-time 'variable overlapping' could occur during the transition between heating and cooling, due to the matching of the variable at the end of a time cycle. However, such overlapping will be corrected at the end of a PWM time cycle. Only if heating or cooling energy is required in one of the operating modes and, consequently, the command value is > "0" the "⌘" or "❄" icon will appear on the display.

Heating/cooling message

Depending on the set operating mode, separate objects can be used to signal whether the controller for the first control circuit is currently demanding heating or cooling energy and is thus actively heating ⌘ or cooling ❄. As long as the heating command value is > "0", a "1" telegram will be transmitted through the "Heating" signal object. The signal telegram is only reset when the command value is "0" ("0" telegram is transmitted). The same applies to the signal object for cooling.

- i** The signal object indicate the energy demand only for the first control circuit.

- i** With 2-point feedback control, it should be noted that the  or  icons will light up on the display or that the message objects for heating and cooling will already become active as soon as the temperature falls short of the temperature setpoint of the active operating mode in case of heating or exceeds the temperature setpoint in case of cooling. In this case, the configured hysteresis is not taken into account.

The signal objects can be enabled by the "Heating message" or "Cooling message" parameters in the "Room temperature control -> Command value and status output" parameter branch. The control algorithm controls the signal objects. Please note that the command value is recalculated every 30 s, followed by an updating of the signal objects.

4.2.4.2.2 Control algorithms and calculation of command values

Introduction

To facilitate convenient temperature control in living or business spaces a specific control algorithm which controls the installed heating or cooling systems is required. Taking account of the preset temperature setpoints and the actual room temperature, the controller thus determines command values which trigger the heating or the cooling system. The control system (control circuit) consists of a room temperature controller, a valve actuator or switch actuator (when ETD electrothermal drives are used), the actual heating or cooling element (e.g. radiator or cooling ceiling) and of the room. This results in a controlled system (Figure 29).

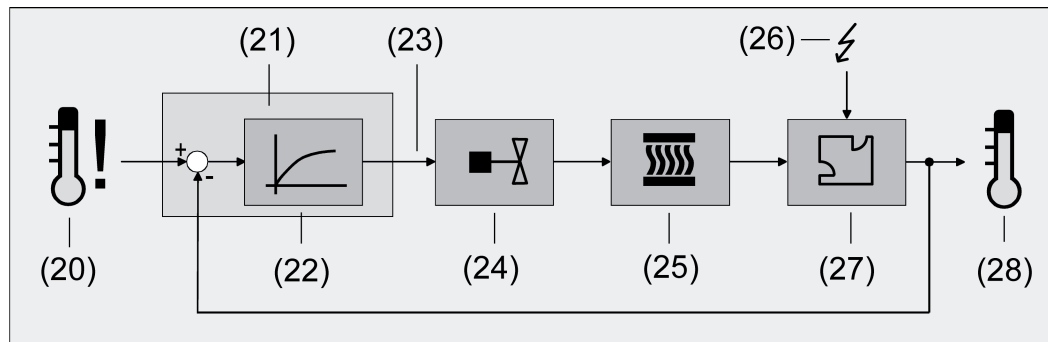

Figure 29: Controlled system of single-room temperature control

- (20) Setpoint temperature specification
- (21) Room temperature controller
- (22) Control algorithm
- (23) Command value
- (24) Valve control (actuating drive, ETD, heating actuator, ...)
- (25) Heat / cold exchanger (radiator, cooling ceiling, FanCoil, ...)
- (26) Fault variable (sunlight penetration, outdoor temperature, illumination systems, ...)
- (27) Room
- (28) Actual temperature (room temperature)

The controller measures the actual temperature (28) and compares it with the given setpoint temperature (20). With the aid of the selected control algorithm (22), the command value (23) is then calculated from the difference between the actual and the setpoint temperature. The command value controls valves or fans for heating or cooling systems (24), meaning that heating or cooling energy in the heat or cold exchangers (25) is passed into the room (27). Regular readjustment of the command value means that the controller is able to compensate for setpoint / actual temperature differences caused by external influences (26) in the control circuit. In addition, the flow temperature of the heating or cooling circuit influences the control system which necessitates adaptations of the variable.

The room temperature controller facilitates either proportional/integral (PI) feedback control as a continuously working or switching option, or, alternatively, switching 2-point feedback control. In some practical cases, it can become necessary to use more than one control algorithm. For example, in bigger systems using floor heating, one control circuit which solely triggers the floor heating can be used to keep the latter at a constant temperature. The radiators on the wall, and possibly even in a side area of the room, will be controlled separately by an additional level with its own control algorithm. In such cases, distinction must be made between the different types of control, as floor heating systems, in most cases, require control parameters which are different to those of radiators on the wall, for example. It is possible to configure up to four independent control algorithms in two-level heating and cooling operation.

Push-button sensor 3 plus offers the option to activate one or, alternatively, two control circuits. The "control circuits" parameter in the "Room temperature control -> Controller general" parameter branch sets the number of control circuits...

- Using one control circuit:
If you use only one control circuit, you have the option of configuring the "Heating", "Cooling" or, as an alternative, the mixed "Heating and cooling" operating modes. Use of the additional stages is also possible in every case. In this connection, you can set different control algorithms for the heating and/or cooling system. Thus, you can use up to four separate algorithms for two-stage heating or cooling operation.
- Using two control circuits:
If you use two control circuits you can only choose between the "heating" or "cooling" mode. In this connection, both control circuits will always work in the same operating mode (comfort, standby, etc.). However, you can set different control algorithms for both control circuits. For this type of parameterization, the use of two-stage control is not intended. Both control circuits can alternatively work with joint or with separate set values.

The command values calculated by the control algorithm are output via the "Heating command value" or "Cooling command value" communication objects. Depending on the control algorithm selected for the heating and/or cooling mode, the format of the command value objects is, among other things, also specified. 1-bit or 1-byte actuating objects can be created in this way (see page 155). The control algorithm is specified by the parameters "Type of heating control" or "Type of cooling control" in the "Room temperature control -> Controller general" parameter branch and, if necessary, also with a distinction of the basic and additional stages.

Continuous PI control

PI control is an algorithm which consists of a proportional part and an integral part. Through the combination of these control properties, you can obtain room temperature control as quickly and precisely as possible without or only with low deviations.

When you use this algorithm, the room temperature controller will calculate a new continuous command value in cycles of 30 seconds and send it to the bus via a 1-byte value object if the calculated command value has changed by a specified percentage. You can use the "Automatic transmission on change by..." parameter in the "Room temperature control -> Command value and status output" parameter branch to set the change interval in percent.

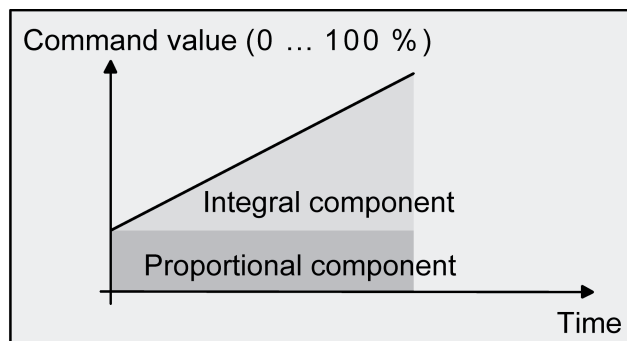

Figure 30: Continuous PI control

An additional heating or cooling level as PI control works in the same way as the PI control of the basic level, with the exception that the setpoint will shift, taking account of the configured

level width.

Switching PI control

With this type of feedback control, the room temperature will also be kept constant by the PI control algorithm. Taking the mean value for a given time, the same behaviour of the control system will result as you would obtain with a continuous controller. The difference compared with continuous feedback control is only the way how the command value is output. The command value calculated by the algorithm in cycles of every 30 seconds is internally converted into a pulse-width-modulated (PWM) command value signal and sent to the bus via a 1-bit switching object after the cycle time has elapsed. The mean value of the command value signal resulting from this modulation is a measure for the averaged position of the control valve, thus being a reference to the room temperature set, taking account of the cycle time which you can set through the "Cycle time of the switching command value..." parameter in the "Room temperature control -> Command value and status output" parameter branch.

A shift of the mean value, and thus a change in the heating capacity, can be obtained by changing the duty factor of the switch-on and switch-off pulses of the command value signal. The duty factor will be adapted by the regulator only at the end of a time period, depending on the variable calculated. This applies to any change of the command value, regardless of what the ratio is by which the command value changes (the "Automatic transmission on change by..." and "Cycle time for automatic transmission..." parameters will have no function in this case). Each command value calculated last during an active time period will be converted. Even after you have changed the setpoint temperature, for example, by switching over the operating mode, the command value will still be adapted after the end of an active cycle time. The diagram below shows the command value switching signal output according to the internally calculated command value (first of all, a command value of 30 %, then of 50 %, with the command value output not being inverted).

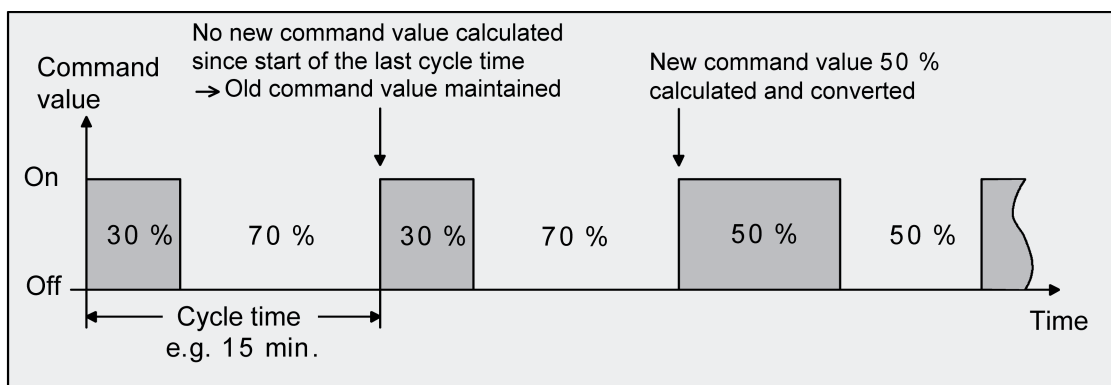

Figure 31: Switching PI control

For a command value of 0 % (permanently off) or of 100 % (permanently on), a command value telegram corresponding to the command value ("0" or "1") will always be sent after a cycle time has elapsed.

For switching PI control, the controller will always use continuous command values for internal calculation. Such continuous values can additionally be sent to the bus via a separate 1-byte value object, for example, as status information for visualisation purposes (if necessary, also separately for the additional levels). The status value objects will be updated at the same time as the command value is output and will only take place after the configured cycle time has elapsed. The parameters "automatic transmission on change by..." and "Cycle time for automatic transmission..." parameters will have no function in this case. An additional heating or cooling level as switching PI control works in the same way as the PI control of the basic stage, with the exception that the setpoint will shift, taking account of the configured level width. All

PWM control options will use the same cycle time.

Cycle time:

The pulse-width-modulated command values are mainly used for activating electrothermal drives (ETD). In this connection, the room temperature controller sends the switching command value telegrams to a switch actuator equipped with semiconductor switching elements to which the drives are connected (e.g. heating actuator or room actuator). By setting the cycle time of the PWM signal on the controller, you can adapt the feedback control to the drives used. The cycle time sets the switching frequency of the PWM signal and allows adaptation to the adjusting cycle times of the actuators used (the adjusting time it takes the drive to bring the valve from its completely closed to its completely opened position). In addition to the adjusting cycle time, take account of the dead time (the time in which the actuators do not show any response when being switched or off). If different actuators with different adjusting cycle times are used, take account of the longest of the times. Always note the information given by the manufacturers of the actuators.

During cycle time configuration, a distinction can always be made between two cases...

Case 1: Cycle time $> 2 \times$ adjusting cycle time of the electrothermal drives used (ETD)

In this case, the switch-on or switch-off times of the PWM signal are long enough for the actuators to have sufficient time to fully open or fully close within a given time period.

Advantages:

The desired mean value for the command value and thus for the required room temperature will be set relatively precisely, even for several actuators triggered at the same time.

Disadvantages:

It should be noted, that, due to the full valve lift to be continuously 'swept', the life expectancy of the actuators can diminish. For very long cycle times (> 15 minutes) with less sluggishness in the system, the heat emission into the room, for example, in the vicinity of the radiators, can possibly be non-uniform and be found disturbing.

- i** This setting is recommended for sluggish heating systems (such as underfloor heating).
- i** Even for a bigger number of triggered actuators, maybe of different types, this setting can be recommended to be able to obtain a better mean value of the adjusting travels of the valves.

Case 2: Cycle time $<$ adjusting cycle time of the electrothermal drives used (ETD)

In this case, the switch-on or switch-off times of the PWM signal are too short for the actuators to have enough time to fully open or fully close within a given period.

Advantages:

This setting ensures continuous water flow through the radiators, thus facilitating uniform heat emission into the room.

If only one actuator is triggered the regulator can continuously adapt the variable to compensate the mean value shift caused by the short cycle time, thus setting the desired room temperature.

Disadvantages:

If more than one drive is triggered at the same time the desired mean value will become the command value, which will result in a very poor adjustment of the required room temperature, or in adjustment of the latter with major deviations, respectively.

The continuous flow of water through the valve, and thus the continuous heating of the drives causes changes to the dead times of the drives during the opening and closing phase. The short cycle time and the dead times means that the required variable (mean value) is only set with a possibly large deviation. For the room temperature to be regulated constantly after a set time, the controller must continually adjust the command value to compensate for the mean value shift caused by the short cycle time. Usually, the control algorithm implemented in the controller (PI control) ensures that control deviations are compensated.

- i** This setting is recommended for quick-reaction heating systems (such as surface radiators).

2-point feedback control

2-point feedback control represents a very simple temperature control. For this type of feedback control, two hysteresis temperature values are set. The actuators are triggered by the controller via switch-on and switch-off command value commands (1-bit type). A continuous variable is not calculated for this type of control.

The room temperature is also evaluated by this type of control in cycles every 30 seconds. Thus the command values change, if required, only at these times. The disadvantage of a continuously varying temperature as a result of this feedback control option is in contrast with the advantage of this very simple 2-point room temperature control. For this reason, quick-reaction heating or cooling systems should not be triggered by a 2-point feedback control system, for this can lead to very high overshooting of the temperature, thus resulting in loss of comfort. When presetting the hysteresis limiting values, you should distinguish between the operating modes.

"Heating" or "cooling" single operating modes:

In heating mode, the controller will turn on the heating when the room temperature has fallen below a preset limit. In heating mode, the feedback control will only turn off the heating once a preset temperature limit has been exceeded.

In cooling mode, the controller will turn on the cooling system when the room temperature has exceeded a preset limit. The control system will only turn off the cooling system once the temperature has fallen below a preset limit. In this connection, variable "1" or "0" will be output, depending on the switching status, if the temperature exceeds or falls below the hysteresis limits.

The hysteresis limits of both operating modes can be configured in the ETS.

- i** It has to be pointed out that the " ⌘ " or " ❄ " icons will light up on the display or that the message objects for heating and cooling will already become active as soon as the temperature falls short of the temperature setpoint of the active operating mode in case of heating or exceeds the temperature setpoint in case of cooling. In this case the hysteresis is not being considered.

The following two images each show a 2-point feedback control for the individual operating modes "Heating" (Figure 32) or "Cooling" (Figure 33). The images take two temperature setpoints, one-stage heating or cooling and non-inverted command value output.

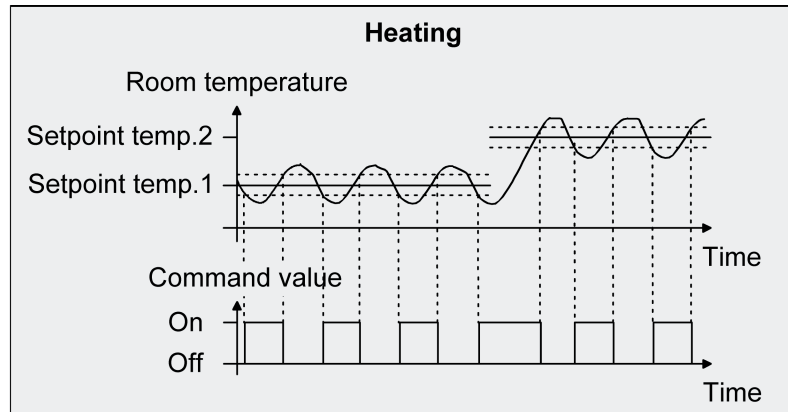

Figure 32: 2-point feedback control for the single "Heating" operating mode

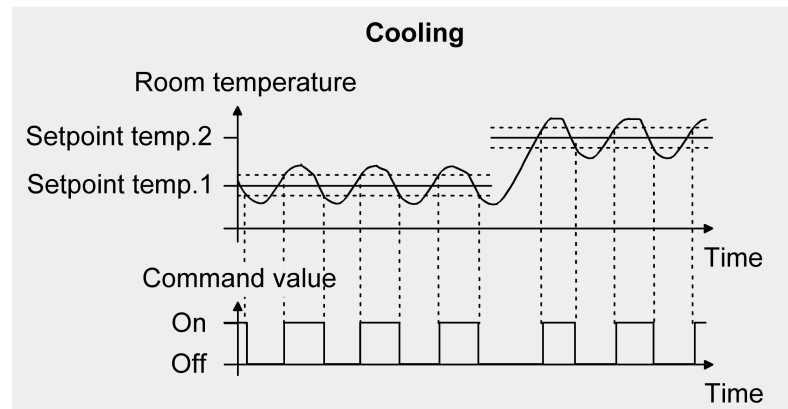

Figure 33: 2-point feedback control for the single "Cooling" operating mode

An additional 2-point feedback control heating or cooling level works exactly the same as the 2-point feedback control of the basic level. The difference is that the setpoint and the hysteresis values will shift by taking into account the configured level offset.

"Heating and cooling" mixed operating mode:

In mixed operation, a distinction is made whether the change-over between heating and cooling is to be effected automatically or in a controlled way through the object...

- With automatic operating mode change-over, in the heating mode the controller will turn on the heating when the room temperature has fallen below a preset hysteresis limit. In this case, as soon as the room temperature exceeds the setpoint of the current operating mode, the feedback control will turn off the heating in the heating mode. Similarly, in cooling mode, the controller will turn on the cooling system when the room temperature has exceeded a preset hysteresis limit. As soon as the room temperature falls below the setpoint of the current operating mode, the feedback control will turn off the cooling system in the cooling mode. Thus, in mixed operation, there is no upper hysteresis limit for heating or no lower one for cooling, respectively, for these values would be in the deadband. Within the deadband, neither heating nor cooling will take place.

- With operating mode change-over via the object, in the heating mode, the controller will turn on the heating when the room temperature has fallen below a preset hysteresis limit. The feedback control will only turn off the heating in the heating mode once the preset upper hysteresis limit has been exceeded. Similarly, in cooling mode, the controller will turn on the cooling system when the room temperature has exceeded a preset hysteresis limit. The feedback control will only turn off the cooling system in the cooling mode once the temperature has fallen below the preset lower hysteresis limit. As with the individual modes of heating or cooling, there are two hysteresis limits per operating mode. Although there is a deadband for the calculation of the temperature setpoints for cooling, it has no influence of the calculation of the two-point control value, as the operating mode is switched over "manually" through the corresponding object. Within the hysteresis spans, it thus will be possible to request heating or cooling energy for temperature values that are located within the deadband.

- i** Also with an automatic operating mode switch, an upper hysteresis limit for heating and a lower hysteresis limit for cooling can be configured in the ETS for 2-point feedback control, although they have no function.

The following two images show 2-point feedback control for the mixed operating mode "Heating and cooling", distinguishing between heating mode (Figure 34) and cooling mode (Figure 35). The images take two temperature setpoints, a non-inverted command value output and an automatic operating mode change-over. When the operating mode is switched over via the object, an upper hysteresis for heating and a lower hysteresis for cooling can be configured.

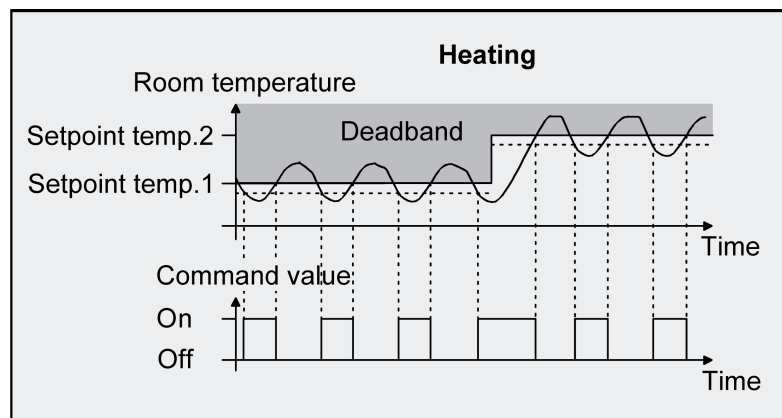

Figure 34: 2-point feedback control for mixed "Heating and cooling" mode with active heating mode.

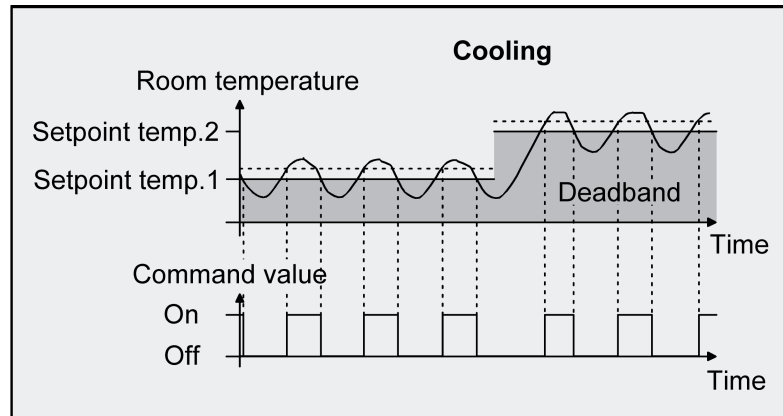

Figure 35: 2-point feedback control for mixed "Heating and cooling" mode with active cooling operation.

Depending on the switching state, the command value "1" or "0" will be output if the values exceed or remain under the hysteresis limits or the setpoints.

- i It has to be pointed out that the " ⌘ " or " ❄ " icons will light up on the display or that the message objects for heating and cooling will already become active as soon as the temperature falls short of the temperature setpoint of the active operating mode in case of heating or exceeds the temperature setpoint in case of cooling. In this case the hysteresis is not being considered.

An additional 2-point feedback control heating or cooling level works exactly the same as the 2-point feedback control of the basic level. The difference is that the setpoint and the hysteresis values will shift by taking into account the configured level offset.

4.2.4.2.3 Adapting the control algorithms

Adapting the PI control

There are several systems available, which may heat or cool a room. One option is to uniformly heat or cool the surroundings via heat transfer media (preferably water or oil) in connection with room air convection. Such systems are used, for example, with wall mounted heaters, underfloor heating or cooling ceilings.

Alternatively or additionally forced air systems may heat or cool rooms. In most cases such systems are electrical forced hot air systems, forced cool air systems or refrigerating compressors with fan. Due to the direct heating of the room air such heating and cooling systems work quite swiftly.

The control parameters need to be adjusted so that the PI control algorithm may efficiently control all common heating and cooling systems thus making the room temperature control work as fast as possible and without deviation. Certain factors can be adjusted with a PI control that can influence the control behaviour quite significantly at times. For this reason, the room temperature controller can be set to predefined 'experience values' for the most common heating and cooling systems. In case the selection of a corresponding heating or cooling system does not yield a satisfactory result with the default values, the adaptation can optionally be optimised using control parameters.

Predefined control parameters for the heating or cooling level and, if applicable, also for the additional levels and the second control circuit are adjusted via the "Type of heating" or "Type of cooling" parameters. These fixed values correspond to the practical values of a properly planned and executed air conditioning system and will result in an ideal behaviour of the temperature control. The heating and cooling types shown in the following tables can be specified for heating and cooling operation.

Type of heating	Proportional range (preset)	Reset time (preset)	Recommended PI control type	Recommended PWM cycle time
Heat water heating	5 Kelvin	150 minutes	Continuous / PWM	15 min.
Underfloor heating	5 Kelvin	240 minutes	PWM	15-20 min.
Electrical heating	4 Kelvin	100 minutes	PWM	10-15 min.
Fan coil unit	4 Kelvin	90 minutes	Continuous	---
Split unit (split climate control unit)	4 Kelvin	90 minutes	PWM	10-15 min.

Table 2: Predefined control parameters and recommend control types for heating systems

Cooling type	Proportional range (preset)	Reset time (preset)	Recommended PI control type	Recommended PWM cycle time
Cooling ceiling	5 Kelvin	240 minutes	PWM	15-20 min.
Fan coil unit	4 Kelvin	90 minutes	Continuous	---
Split unit (split climate control unit)	4 Kelvin	90 minutes	PWM	10-15 min.

Table 3: Predefined control parameters and recommend control types for cooling systems

If the "Type of heating" or "Type of cooling" parameters are set to "Via control parameters" it will be possible to adjust the control parameter manually. The feedback control may be considerably influenced by presetting the proportional range for heating or for cooling (P component) and the reset time for heating or for cooling (I component).

- i** Even small adjustments of the control parameters will lead to noticeable different control behaviour.
- i** The adaptation should start with the control parameter setting for the corresponding heating or cooling system according to the fixed values mentioned in Tables 3 & 4.

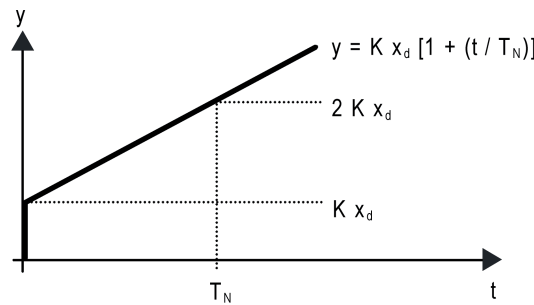

Figure 36: Function of the command value of a PI control

y: Command value
 x_d : Control difference ($x_d = x_{set} - x_{act}$)
 $P = 1/K$: Configurable proportional band
 $K = 1/P$: Gain factor
 T_N : Configurable reset time

PI control algorithm: Command value $y = K x_d [1 + (t / T_N)]$

Deactivation of the reset time (setting = "0") ->
 P control algorithm: Command value $y = K x_d$

Parameter setting	Effect
P: Small proportional range	Large overshoot in case of setpoint changes (possibly permanently), quick adjustment to the setpoint
P: Large proportional range	no (or small) overshooting but slow adjustment
T_N : Short reset time	Fast compensation of control deviations (ambient conditions), risk of permanent oscillations
T_N : Long reset time	Slow compensation of control deviations

Table 4: Effects of the settings for the control parameters

Adapting the 2-point feedback control

2-point feedback control represents a very simple temperature control. For this type of feedback control, two hysteresis temperature values are set. The upper and lower temperature hysteresis limits can be adjusted via parameters. It has to be considered that...

- A small hysteresis will lead to small temperature variations but to a higher bus load.
- A large hysteresis switches less frequently but will cause uncomfortable temperature variations.

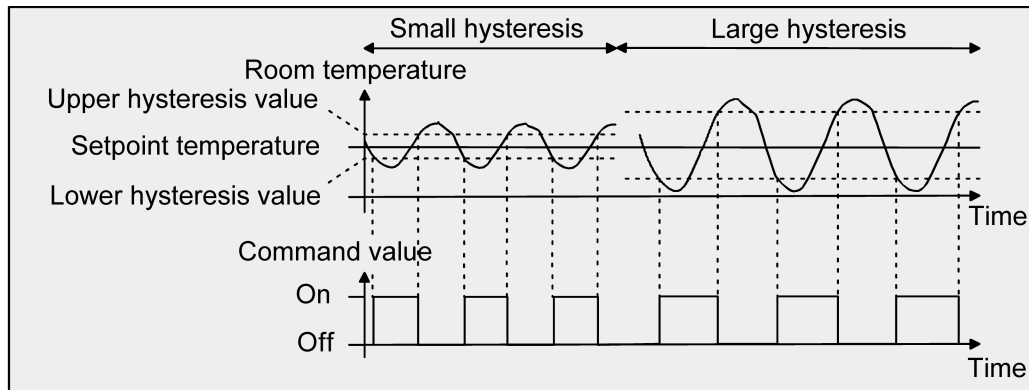









Figure 37: Effects of the hysteresis on the switching behaviour of the command value of 2-point feedback control

4.2.4.2.4 Operating mode switchover

Introduction - The operating modes

The room temperature controller has various operating modes. The selection of these modes will, for example, facilitate the activation of different temperature setpoints, depending on the presence of a person, on the state of the heating or cooling system, on the time of the day, or on the day of the week. The following operating modes can be distinguished...

- Comfort mode
Comfort mode is usually activated if persons are in a room, and the room temperature should, for this reason, be adjusted to an adequately convenient value. The change-over to this operating mode can take place either by pressing a button or with presence control, for example, using a PIR motion detector on the wall or a ceiling mounted detector. The activated Comfort mode will be indicated on the display by the  icon.
 - Standby mode
If a room is not used during the day because persons are absent, you can activate the Standby mode. Thereby, you can adjust the room temperature on a standby value, thus to save heating or cooling energy, respectively. The activated standby mode will be indicated on the display by the  icon.
 - Night operation
During the night hours or during the absence of persons for a longer time, it mostly makes sense to adjust the room temperature to lower values for heating systems (e.g. in bedrooms). In this case, cooling system can be set to higher temperature values, if air conditioning is not required (e.g. in offices). For this purpose, you can activate the Night mode. The activated Night mode will be indicated on the display by the  icon.
 - Frost/heat protection mode
Frost protection will be required if, for example, the room temperature must not fall below critical values while the window is open. Heat protection can be required where the temperature rises too much in an environment which is always warm, mainly due to external influences. In such cases, you can activate the Frost/heat protection operating mode and prescribe some temperature setpoint of its own for either option, depending on whether "Heating" or "Cooling" has been selected, to prevent freezing or overheating of the room. The activated Frost/heat protection mode will be indicated on the display by the   icon.
 - Comfort extension (temporary Comfort mode)
You can activate the comfort extension from the night or frost/heat protection mode (not triggered by the "Window status" object) and use it to adjust the room temperature to a comfort value for some time if, for example, the room is also 'used' during the night hours. This mode can exclusively be activated by a presence button or also by the presence object, respectively. The comfort extension option will be automatically deactivated after a definable time has elapsed, or by pressing the presence button once more, or by receiving a presence object value = 0, respectively. You cannot retrigger this extension. The activated comfort extension option will be indicated on the display by the  icon.
-  You can assign an own temperature setpoint to the "Heating" or "Cooling" operating modes for each operating mode.
-  Only one operating mode can be activated at a time so that both control circuits will always be in the same mode if two control circuits are used.

Operating mode switchover

You can activate or switch over the operating modes in various ways. Depending on one another in priority, activation or change-over is possible by...

- Local control on the push-button sensor using button function (controller operation) and configured operating mode switchover,
- Local control on the push-button sensor in the configuration menu,
- The 1-bit communication objects separately available for each operating mode or alternatively through the KNX objects. In the last case, also through a controller extension.

The following section describes the individual options for changing over the operating modes in more detail.

Switch-over of the operating mode in the configuration menu

The configuration menu is called up if the normal display is active and at the same time the left and right mouse buttons are pressed. After that the menu "Settings" is displayed. The selection can be confirmed by pressing the the right display button ✓. The display then goes to the main menu of the device settings.

Selecting and confirming the menu item "Operating mode" with **OK** takes the display to the corresponding submenu of the operating mode switchover (see page 23-24). At this point, is possible to activate the "Comfort", "Standby", "Night" or "Frost/heat protection" operating modes. Switch-over to comfort extension is not possible here.

Switch-over of the controller operating mode in the configuration menu is possible both on main controllers and on controller extensions.

- i** The presence message, the window status and the forced object for operating mode change-over have a higher priority than the change-over of the operating mode via the configuration menu. Therefore, change-overs by evaluating the appropriate objects have priority.

Change-over of the operating mode using button function

As soon as a button of the push-button sensor is configured to "Controller operation", the "Operating mode switchover" function can be configured in the button parameters. In this case, a further definition is required in the ETS configuration as to which operating mode is activated when a button is pressed. For this purpose, the "comfort", "standby", "night" and "frost/heat protection" modes are available.

To be able to activate the comfort extension, it is possible to use a presence button either optionally or in addition. The presence button, just as with the operating mode switchover, is a button function of the push-button sensor for controller operation. The presence button means it is possible to change to the comfort extension or to deactivate it prematurely when Night or Frost/heat protection mode (not activated by the "Window status" object) has been activated. Also, it is possible to change over from the Standby to the Comfort mode when the presence button is pressed.

The function of the status LED of a button can be configured irrespective of the button function. For example, it is possible that the controller status LED is controlled by a separate communication object.

Change-over of the operating mode using KNX/EIB communication objects

A distinction is made whether the operating modes should be changed over via separate 1-bit objects or, alternatively, by the 1-byte KNX objects.

The "Operating mode change-over" parameter in the "Room temperature control -> Controller general" parameter branch specifies the switching method as follows...

- Operating mode change-over "Via switching (4 x 1 bit)"

There is a separate 1-bit change-over object for each operating mode. Each of these objects allows the current operating mode to be switched over or to be set, depending on the priority. Taking account of the priority, a specific hierarchy will result from the operating mode change-over by the objects, a distinction being made between presence detection by the presence button (Figure 38) or the presence detector (Figure 39). In addition, the status of the window in the room can be evaluated using the "Window status" object, meaning that, when the window is open, the controller can switch to Frost/heat protection mode, irrespective of the set operating mode, in order to save energy.

Table 5 also shows the status of the communication objects and the resulting operating mode.

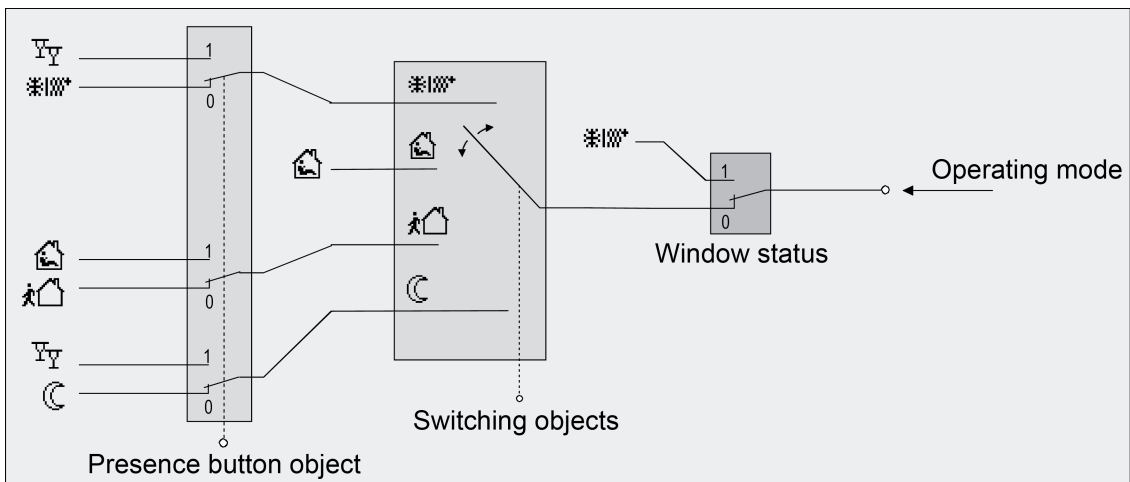

Figure 38: Operating mode change-over through 4 x 1-bit objects with presence button

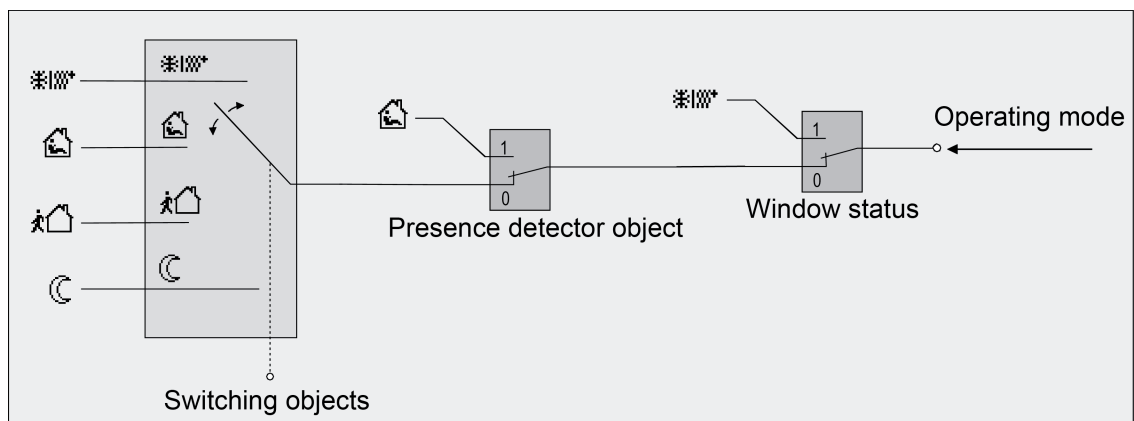

Figure 39: Operating mode change-over through 4 x 1-bit objects with presence detector

Object	Object	Object	Object	Object "Window status"	Motion button	Motion detector	Resulting operating mode

1	X	X	X	0	0	-	Frost/heat protection
0	1	X	X	0	0	-	Comfort mode
0	0	1	X	0	0	-	Standby mode
0	0	0	1	0	0	-	Night operation
0	0	0	0	0	0	-	As parameter *
X	X	X	X	1	X	-	Frost/heat protection
1	X	X	X	0	1	-	Comfort extension
0	1	X	X	0	1	-	Comfort mode
0	0	1	X	0	1	-	Comfort mode
0	0	0	1	0	1	-	Comfort extension
0	0	0	0	0	1	-	Comfort mode/extension **
1	X	X	X	0	-	0	Frost/heat protection
0	1	X	X	0	-	0	Comfort mode
0	0	1	X	0	-	0	Standby mode
0	0	0	1	0	-	0	Night operation
0	0	0	0	0	-	0	As parameter *
X	X	X	X	1	-	X	Frost/heat protection
X	X	X	X	0	-	1	Comfort mode

Table 5: Status of the communication objects and the resulting operating mode

X: Status irrelevant

-: Not possible

*: Operating mode as parameter "Operating mode, when all bit objects = 0 (preferential position)".

** : Dependent on the last active operating mode.

- i** When changing over the operating mode, the objects "Comfort mode", "Standby mode", "Night mode" and "Frost/heat protection" are updated by the controller and can be read out when the appropriate Read flags are set. If the "Transmit" flag has been set for these objects the current values will, in addition, be automatically transmitted to the bus when they are changed. After bus voltage recovery or after initialisation of the controller, the object which corresponds to the selected operating mode will be updated and its value actively transmitted to the bus if the "Transmit" flag has been set.
- i** A switchover by the objects has the same importance as a local switchover on the push-button sensor (configuration menu, button as controller operation). An operating mode set by an object can therefore be shifted by an operating mode change-over on the device, if no higher-priority mode (e.g. window contact / presence detector) is activated.
- i** In parameterisation of a presence button: the presence object will be active ("1") for the period of an comfort extension. The presence object will be automatically deleted ("0") if the comfort extension is stopped after the extension time has elapsed, or if the operating mode has been changed by a higher-priority operation through the change-over objects or by local control. The controller therefore automatically resets the status of the presence button when an object is received via the operating mode objects.

i Only one operating mode can be activated at a time so that both control circuits will always be in the same mode if two control circuits are used. The operating mode switch-over of the second control circuit always proceeds in parallel with the first control circuit.

- Operating mode change-over through "value (1 byte)"

There is a common 1-byte change-over object for all operating modes. During the running time, the operating mode can be changed over through this value object immediately after the receipt of only one telegram. In this connection, the value received will set the operating mode. In addition, a second 1-byte object is available which, by forced control and through higher level, can set an operating mode, irrespective of any other change-over options. According to the KNX specification, both 1-byte objects have been implemented. Taking account of the priority, a specific hierarchy will result from the operating mode change-over by the objects, a distinction being made between presence detection by the presence button (Figure 40) or the presence detector (Figure 41). In addition, the status of the window in the room can be evaluated using the "Window status" object, meaning that, when the window is open, the controller can switch to Frost/heat protection mode, irrespective of the set operating mode, in order to save energy. Table 6 also shows the status of the communication objects and the resulting operating mode.

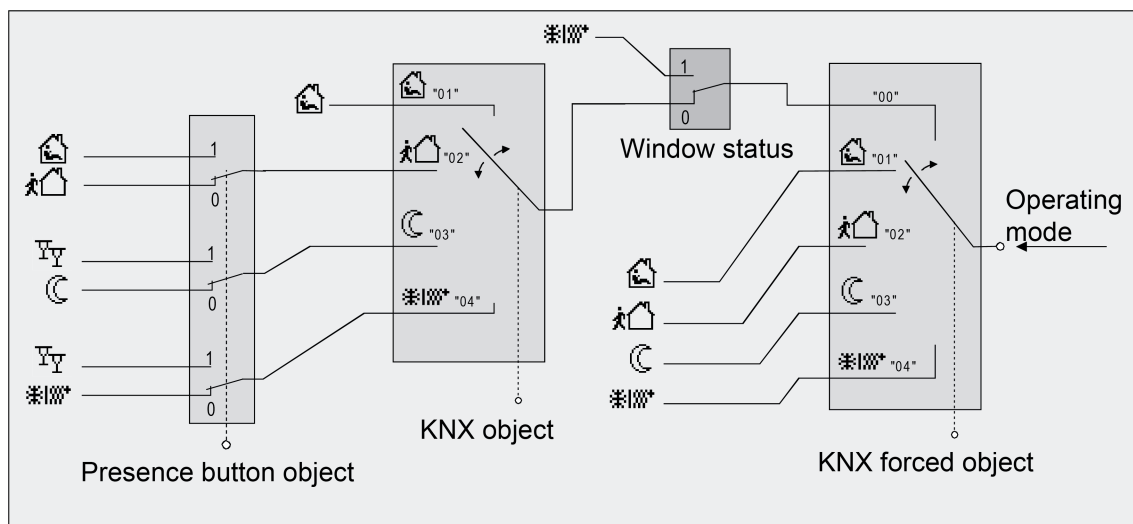

Figure 40: Operating mode change-over through KONNEX object with presence button

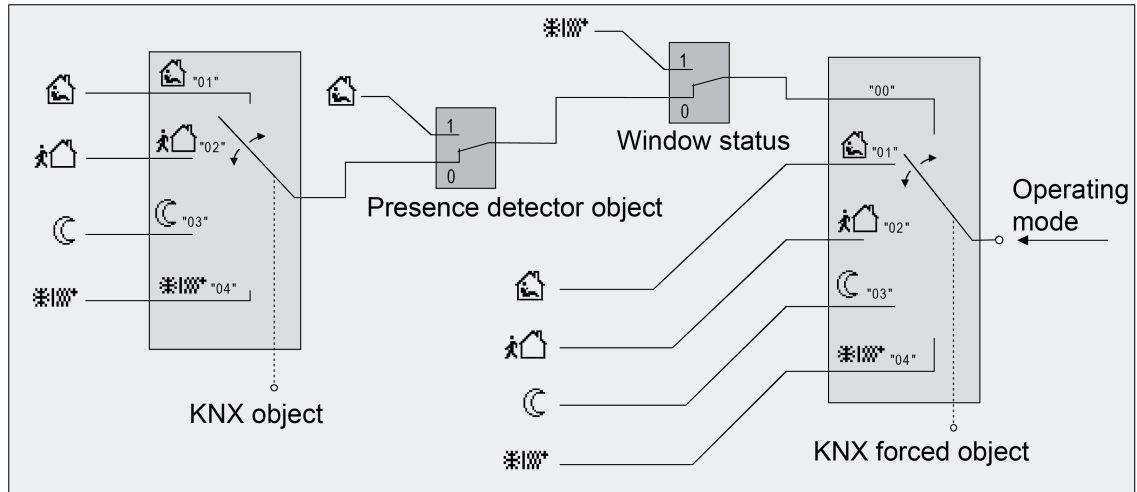

Figure 41: Operating mode change-over through KONNEX object with presence detector

Object value "Operating mode change-over"	Object value "Forced object operating mode"	Object "Window status"	Motion button	Motion detector	Resulting operating mode
00	00	0	X	0	No modification
01	00	0	0	-	Comfort mode
02	00	0	0	-	Standby mode
03	00	0	0	-	Night operation
04	00	0	0	-	Frost/heat protection
01	00	0	1	-	Comfort mode
02	00	0	1	-	Comfort mode
03	00	0	1	-	Comfort extension
04	00	0	1	-	Comfort extension
01	00	0	-	0	Comfort mode
02	00	0	-	0	Standby mode
03	00	0	-	0	Night operation
04	00	0	-	0	Frost/heat protection
X	00	0	-	1	Comfort mode
X	00	1	-	X	Frost/heat protection
X	00	1	X	-	Frost/heat protection
X	01	X	X	X	Comfort mode
X	02	X	X	X	Standby mode
X	03	X	X	X	Night operation
X	04	X	X	X	Frost/heat protection

Table 6: Status of the communication objects and the resulting operating mode

X: Status irrelevant

-: Not possible

- i** When changing over an operating mode, for example through local control, the KNX switching object is updated by the controller and can be read out when the "Read" flag is set. If the "Transmit" flag has been set for this object the current value will, in addition, be automatically transmitted to the bus when it is changed.
After a device reset, the value corresponding to the set operating mode will be actively transmitted to the bus if the "Transmit" flag has been set.
- i** Switchover by the KNX object "Operating mode switchover" has the same priority as a local switchover on the push-button sensor. An operating mode specified by the object (e.g. by a controller extension) can therefore be shifted by an operating mode switchover on the device, if no higher-priority mode (e.g. window contact / presence detector) or the KNX forced object is activated.
The KNX forced object will always have the highest priority.
- i** In parameterisation of a presence button: the presence object will be active ("1") for the period of an active comfort extension. The presence object will be automatically deleted ("0") if the comfort extension is stopped after the extension time has elapsed, or if the operating mode has been changed by a higher-priority operation through the change-over objects or by local control or a forced operating mode is deactivated by the KNX forced object (forced object -> "00"). The controller therefore automatically resets the status of the presence button when an object value is received via the operating mode objects or the forced object is reset.
- i** Only one operating mode can be activated at a time so that both control circuits will always be in the same mode if two control circuits are used. The operating mode switch-over of the second control circuit always proceeds in parallel with the first control circuit.

Additional information on the Presence function / Comfort extension

With presence detection, the room temperature controller can quickly change over to a comfort extension upon push button actuation or go into the Comfort mode when movement by a person in the room is detected. In this connection, the "Presence detection" parameter in the "Room temperature control -> Controller functionality" parameter node sets whether presence detection should be movement-controlled by a motion detector or manual through presence button actuation...

- Presence detection by the presence button
If the presence button is configured for presence detection, you can select the "Presence button" setting in the "Controller operation" push-button sensor button functions. In addition, the "Presence object" is enabled. In this way, you can actuate the presence button or use a presence object value = "1" to change over to comfort extension when the Night or the Frost/heat protection mode is active (not activated by the "window status" object). The extension will be automatically deactivated as soon as the configured "Length of comfort extension" time has elapsed. If you press the presence button once more, or if the presence object receives a value = "0", you can deactivate the comfort extension earlier. You cannot re-trigger such extension time.
If you have set the length of comfort extension to "0" in the ETS, you cannot activate a comfort extension from the night or frost/heat protection mode. In this case, the operating mode will not be changed, although the presence function has been activated.
If the standby mode is active you can operate the presence button or use a presence object value = "1" to change over to the comfort mode. This will also be the case if you have configured the length of comfort extension to "0". The comfort mode will remain active as long as the presence function remains active, or until another operating mode comes into effect.
The presence object or the presence function, respectively, will always be deleted whenever a change-over to a different operating mode takes place, or after a forced operating mode has been deactivated (associated with KNX forced change-over). A presence function activated before a device reset (programming operation, bus voltage failure) is always deleted, along with the object value, after the reset.

 - Presence detection by the presence detector
If a motion detector is configured for motion detection, then the controller only evaluates the "Presence object". With this object, it is possible to integrate presence detectors into room temperature control. If a movement is detected ("1" telegram) the controller will change over into the Comfort mode. In this connection, it is irrelevant what has been set by the change-over objects or by local control directly on the device. Only a window contact or the KNX forced object are of higher priority.
After the movement delay time has elapsed in the presence detector ("0" telegram), the controller will return to the operating mode which was active before presence detection, or it will compensate the telegrams of the operating mode objects received during presence detection, respectively. During active presence detection, you cannot change-over the operating mode on the room temperature controller.
A presence function activated before a device reset (programming operation, bus voltage failure) is always deleted, along with the object value, after the reset. In this case, the presence detector must transmit a new "1" telegram to the controller to activate the presence function.
- i** If the motion detector is configured for presence detection, it is always possible to configure the presence button in the "Controller operation" push-button sensor button functions. However, this parameterisation then has no effect.

Additional information on the window status and the automatic frost protection

The room temperature controller offers various options to change over into the Frost/heat protection mode. In addition to the switchover by the corresponding operating mode switchover object or by room temperature controller operation on the push-button sensor (button function), the frost/heat protection mode can be activated by a window contact or, alternatively, frost protection can be activated by an automatic temperature control option. With these options, the window contact or the automatic function has higher priority. You can use the "frost/heat protection" parameter in the "room temperature control -> controller general" parameter branch to set the way how such higher-priority switch-over will take place...

- Frost/heat protection switch-over "via window status"
The 1-bit object, "window status" is enabled. A telegram having the value of = "1" (open window) and sent to this object will activate the frost/heat protection mode. If this is the case, the operating mode cannot be deactivated, neither by local operation nor by the switch-over objects (with the exception of the KNX override object), nor by the heating timer. Only a telegram with the value of = "0" (closed window) will reset the window status and deactivate the frost/heat protection mode. After this, the operating mode set before the opening of the window or that mode carried by the bus or the heating timer while the window was open will be activated.
You can optionally parameterise a window status delay. Such delay can make sense if short ventilation of the room by opening the window is not supposed to change the operating mode. You can use the "window status delay" parameter to set this delay time between 1 and 255 minutes. The window status will only be changed and thus the frost/heat protection mode activated after this parameterized time has elapsed. A setting of "0" will effect the immediate activation of the frost/heat protection mode when the window is open. The window status will be in effect in the heating and in the cooling mode. The value of the object "window status" is deleted after a reset.
 - Frost protection mode switch-over by "automatic frost protection"
For this setting, automatic switch-over to the frost protection mode can be made at times, depending on the room temperature determined. If there are no window contacts, this setting can prevent unnecessary heating up of the room when windows or external doors are open. In connection with this function, a quick temperature drop can be detected by measuring the actual temperature every minute as, for example, is the case when a window is open. If the temperature decrease detected reaches a parameterised value the room temperature regulator will automatically switch over to the frost protection mode. You can use the "automatic frost protection temperature drop" parameter to set the maximum temperature drop in K/min for switching over to the frost protection mode. After the time preset by the "frost protection period in automatic mode" parameter has elapsed, the regulator will return into the mode which was set before frost protection. Re-triggering will not be possible.
If a switch-over was made by 1 byte via the KNX change-over object during frost protection and a new operating mode was received, or a new mode has been specified by the heating timer, this followed-up mode will be set after automatic frost protection. If a switch-over was made by 4 x 1 bit during frost protection via the change-over object, then this newly received mode will be discarded after the end of the automatic frost protection. The controller then remains in frost protection. Only after that can the operating mode be switched over by the objects or locally on the push-button sensor. The KNX override object has a higher priority than the automatic frost protection mode and can interrupt the latter.
- i** The automatic frost protection mode only acts on heating for temperatures below the set value temperature of the operating mode selected. Thus, no automatic switchover to frost protection can take place at room temperatures in the deadband or in the active cooling mode if the "Heating and cooling" operating mode is on. Automatic heat protection activation is not intended with this parameterization.

- i** When a window is open or when the automatic frost protection is active, it is not possible to switch over the controller operating mode using buttons with the "Controller operation" function, and not in the menu for the settings. A button press will thus not be effected after the window closes, or at the end of the automatic frost protection.
- i** Frequent draughts in a room can cause unintentional activation/deactivation of frost protection when the automatic frost protection mode is active, and if the parameterized temperature decrease is not low enough. Therefore switching into the frost/heat protection mode by window contacts should generally be preferred to the automatic option.

Additional information on the operating mode after a reset

In the ETS, it is possible to use the "Operating mode after reset" parameter in the "Room temperature control -> Controller general" parameter node to set which operating mode should be activated after bus voltage recovery or re-programming by the ETS. The following settings are possible...

- "Comfort operation" -> The comfort mode will be activated after the initialisation phase.
- "Standby mode" -> The standby mode will be activated after the initialisation phase.
- "Night operation" -> The night mode will be activated after the initialisation phase.
- "Frost/heat protection operation" -> The frost/heat protection mode will be activated after the initialisation phase.
- "Restore operation mode before reset" -> The mode set before a reset according to the operating mode object or by button function (normal priority) will be restored after the initialisation phase of the device. Operating modes set by a function with a higher priority before the reset (Forced, Window status, Presence status) are not effected.

The operating mode objects will be updated after a reset.

- i** Note on the "restore operation mode before reset" setting:
Frequent changing of the operating mode (e. g. several times a day) during running operation can adversely affect the life of the device as the read-only memory (EEPROM) used has been designed for less frequent write access events only.

4.2.4.2.5 Temperature setpoints

Setpoint temperature presetting

Temperature setpoints can be preset for each operating mode in the ETS as part of first configuration. It is possible to configure the setpoints for the "Comfort", "Standby" and "Night" modes directly (absolute setpoint presetting) or relatively (derivation from basic setpoint). If desired, the setpoint temperatures can be subsequently adjusted via local control during operation or controlled by KNX/EIB communication objects.

- i** The "Frost/heat protection" operating mode allows the separate configuration of two temperature setpoints for heating (frost protection) and cooling (heat protection) solely in the ETS. These temperature values cannot be changed later during controller operation.

The "Setpoint presetting" parameter on the parameter page "Room temperature control -> Controller general -> Setpoints" defines the way the setpoint temperature is preset...

- "Relative (setpoint temperatures from basic setpoint)" setting:
When presetting the set-temperatures for comfort, standby and night mode, attention has to be paid to the fact that all setpoints depend on each other as all values are derived from the basic temperature (basic setpoint). The "Basic temperature after reset" parameter in the "Room temperature control -> Controller general -> Setpoints" parameter page determines the basic setpoint, which is loaded when the device is programmed via the ETS. Taking into account the "Reduce / increase the setpoint temperature in standby mode" or "Reduce / increase the setpoint temperature in night mode" parameters the temperature setpoints for the standby and night mode are derived from this value depending on the heating or cooling operating mode. The deadband will be additionally considered for the "Heating and cooling" operating mode (see page 138).
The 2-byte object "Basic setpoint" provides the option of changing the basic temperature, and thus all the dependent setpoint temperatures during device operation. A change via the object must always be enabled in the ETS by configuring the parameter "Change the basic temperature setpoint via bus" or "Change the basic temperature setpoint on device or via bus" to "Approve". If the basic setpoint adjustment via the bus is disabled, the "Basic setpoint" object will be hidden. The controller rounds the temperature values received via the object to the specific step width of the setpoint shift. This is dependent upon the application program used. In Version 1.2 applications, the step width can be configured in the ETS (0.1 K / 0.5 K / 1.0 K). In Version 1.1 applications, the step width is permanently defined as 0.1 K.
Alternatively or additionally, the basic setpoint can be changed locally in the configuration menu on the push-button sensor in the form of the setpoint temperature for "Comfort mode heating" (with only "Heating" or "Heating and cooling"), or in the form of the setpoint temperature for "Comfort mode cooling" (with only "Cooling"). To permit this, the parameter "Changing the setpoint of the basic temperature" must be set to "approve on device" or "approve on device and via bus".
In the operating mode "Heating and cooling" (if necessary with additional levels), it is possible to define in the ETS whether a deadband shift can be performed locally in the configuration menu. If the "Dead band shift" parameter is parameterised to "Approve on device", then it is possible to use the menu to change the setpoint temperature for "Comfort mode cooling" and thus directly the size of the deadband (temperature distance from the setpoint temperature of the heating comfort mode).

- "Absolute (independent setpoint temperatures)" setting
The setpoint temperatures for comfort, standby and night mode are independent of each other. Depending on the operating mode and heating/cooling mode, various temperature values can be specified in the ETS within the range +7.0 °C to +40.0 °C. The ETS plug-in does not validate the temperature values. It is thus possible, for example, to select smaller setpoint temperatures for cooling mode than for heating mode, or to specify lower temperatures for comfort mode than for standby mode.
After commissioning using the ETS the setpoint temperatures can be changed via the bus by means of temperature telegrams. This can be done using the communication object "Setpoint active operating mode". When the controller receives a telegram via this object, it immediately sets the received temperature as the new setpoint of the active operating mode, and operates from then on with this setpoint. In this manner it is possible to adapt the setpoint temperatures of all operating modes separately for heating and cooling mode. The frost or heat protection temperature programmed in using the ETS cannot be changed in this manner.
The controller rounds the temperature values received via the object to the specific step width of the setpoint shift. This is dependent upon the application program used. In Version 1.2 applications, the step width can be configured in the ETS (0.1 K / 0.5 K / 1.0 K). In Version 1.1 applications, the step width is permanently defined as 0.1 K.

- i With absolute setpoint presetting there is no basic setpoint and also no deadband in the mixed operating mode "Heating and cooling" (if necessary also with additional level). Consequently, the room temperature controller cannot control the switchover of the operating mode automatically, which is why, in this configuration, the setting for the parameter "Switchover between heating and cooling" is fixed in the ETS to "Via object" (see page 112-113).
Furthermore, setpoint shifting does not exist for absolute setpoint presetting. It is likewise not possible to edit any setpoint temperatures in the configuration menu.

- i In two-level control mode, all set-temperatures of the additional level are derived from the setpoint temperatures of the basic level. The setpoint temperature of the additional level are determined by subtracting the "Difference between basic and additional levels", which is permanently configured in the ETS, from the setpoints of the basic level in heating mode or by adding the setpoints in cooling mode. If the temperature setpoints of the basic level are changed, the setpoint temperatures of the additional level will be automatically changed as well. Both levels will heat or cool with the same command value at the same time when the level distance is "0".

When using two control circuits it is possible to set shared setpoints or alternatively separate values for both circuits. The "Own setpoints for the 2nd control circuit?" parameter in the parameter branch "Room temperature control -> Controller general -> Setpoints" defines which setpoints should be used for the second control circuit...

- Setting "No"
Both control circuits have the same setpoints for the comfort, standby and night mode. The frost or heat protection temperatures are identical as well. This setting features, if enabled, shared objects and parameters for setting the setpoint temperatures and an object for transmitting the setpoint temperature to the bus.

 - Setting "Yes"
Independent of each, both control circuits have their own setpoints for the comfort, standby and night mode. Only the frost or heat protection temperatures are identical. With this setting there are separate objects and parameters per control circuit available for setting and transmitting the setpoint temperatures, if enabled.
A change of the setpoint temperature in the local configuration menu on the push-button sensor is only possible for the first control circuit. The operating mode switch-over of the second control circuit always takes place parallel to the switch-over of the first control circuit. It is not possible to have a two-stage control and a mixed-mode of heating and cooling with two control circuits.
- i** The setpoint presetting can be configured to "relative" or "absolute" when two control circuits are used, too.

The setpoint temperatures programmed in the room temperature controller by the ETS during commissioning can be changed during device operation locally in the configuration menu or via communication objects. In the ETS the parameter "Overwrite setpoints in device during ETS programming operation?" can be used on the parameter page "Room temperature control -> Controller general -> Setpoints" to define whether the setpoints present in the device, which may have been changed subsequently, are overwritten during an ETS programming operation and thus replaced again by the values parameterised in the ETS. If this parameter is on "Yes", then the temperature setpoints are deleted in the device during a programming operation and replaced by the values of the ETS. If this parameter is configured to "No", then setpoints present in the device remain unchanged. The setpoint temperatures entered in the ETS then have no significance.

- i** During initial commissioning of the device the parameter "Overwrite setpoints in device during ETS programming operation?" must be set to "Yes" in order to perform valid initialisation of the memory slots in the device. The setting "Yes" is also necessary if essential controller properties (operating mode, control circuits, setpoint specification, etc.) are being changed in the ETS using new parameter configurations!

Setpoint temperatures for relative setpoint presetting

Depending on the operating mode, different cases should be distinguished when specifying the relative setpoint temperature, which then have an impact on the temperature derivation from the basic setpoint.

Setpoints for operating mode "Heating"

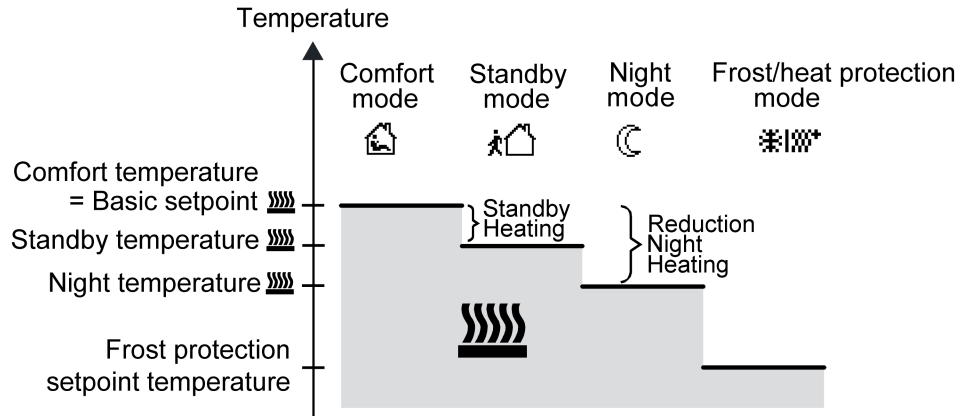

Figure 42: Setpoint temperatures in the operating mode "Heating"

The setpoint temperatures for comfort, standby and night mode exist for this operating mode. The frost protection temperature can be preset (Figure 42). The following applies...

$$T_{\text{Standby setpoint heating}} \leq T_{\text{Comfort setpoint heating}}$$

or

$$T_{\text{Night setpoint heating}} \leq T_{\text{Comfort setpoint heating}}$$

The standby and night setpoint temperatures are derived from the reduction temperatures configured in the ETS from the comfort setpoint temperature (basic setpoint). It is also possible to adjust other decrease temperatures directly via local control in the configuration menu, if enabled in the ETS, by changing the setpoint temperature values for Night and Standby mode. The frost protection is supposed to prevent the heating system from freezing. For this reason the frost protection temperature (default: +7 °C) should be to a set smaller value than the night temperature. In principle, however, it is possible to select frost protection temperature values between +7.0 °C and +40.0 °C. The possible range of values for a setpoint temperature lies between +7.0 °C and +99.9 °C for "heating" and is bounded by the frost protection temperature in the lower range. The level offset configured in ETS will be additionally considered in a two-level heating mode (Figure 43).

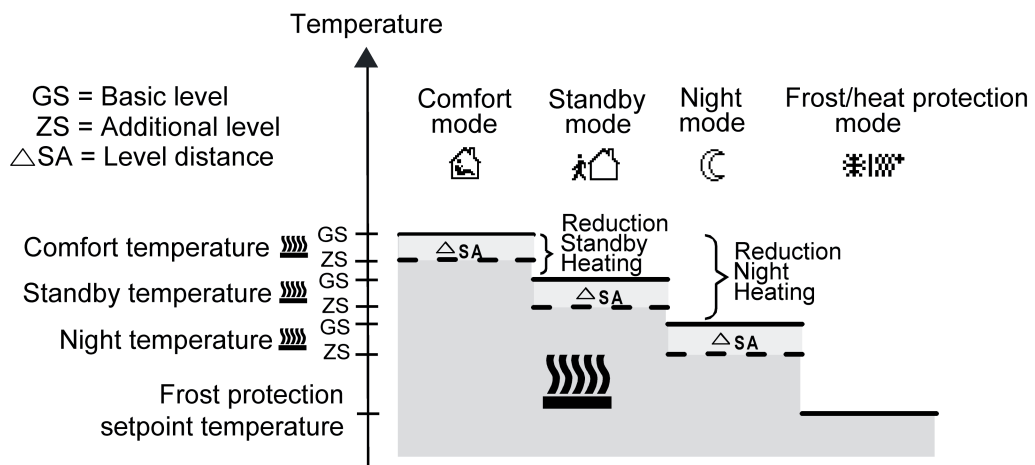

Figure 43: Setpoint temperatures in the operating mode "Basic and additional heating"

$$T_{\text{Comfort setpoint additional level heating}} \leq T_{\text{Comfort setpoint basic level heating}}$$

$$T_{\text{Standby setpoint additional level heating}} \leq T_{\text{Standby setpoint basic level heating}}$$

$$T_{\text{Standby setpoint heating}} \leq T_{\text{Comfort setpoint heating}}$$

or

$$T_{\text{Comfort setpoint additional level heating}} \leq T_{\text{Comfort setpoint basic level heating}}$$

$$T_{\text{Night setpoint additional level heating}} \leq T_{\text{Night setpoint basic level heating}}$$

$$T_{\text{Night setpoint heating}} \leq T_{\text{Comfort setpoint heating}}$$

Setpoints for the "cooling" operating mode

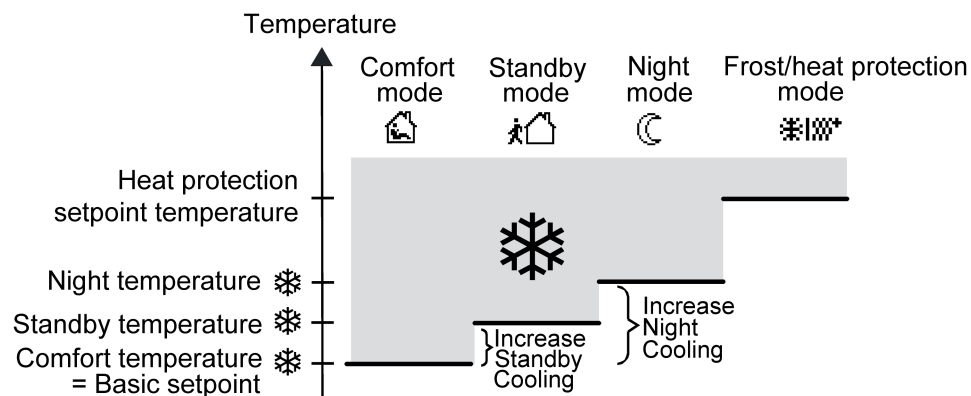

Figure 44: Setpoint temperatures in the operating mode "Cooling"

The setpoint temperatures for Comfort, Standby and Night mode exist in this operating mode and the heat protection temperature can be preset (Figure 44). The following applies...

$$T_{\text{Comfort setpoint cooling}} \leq T_{\text{Standby setpoint cooling}}$$

or

$$T_{\text{Comfort setpoint cooling}} \leq T_{\text{Night setpoint cooling}}$$

The standby and night set-temperatures are derived after the configured increase temperatures from the comfort set-temperature (basic setpoint). It is also possible to adjust other increase temperatures directly via local control in the configuration menu, if enabled in the ETS, by changing the setpoint temperature values for Night and Standby mode. The heat protection is supposed to ensure that the temperature does not exceed the maximum permissible room temperature in order to protect system components. For this reason the heat protection temperature (default: +35 °C) should be set to a larger value than the night temperature. In principle, however, it is possible to select heat protection temperature values between +7.0 °C and +45.0 °C.

The possible range of values for a setpoint temperature lies between -99.9 °C and +45.0 °C for "Cooling" and is bounded by the heat protection temperature in the upper range.

The level offset configured in ETS will be additionally considered in a two-level cooling mode (Figure 45).

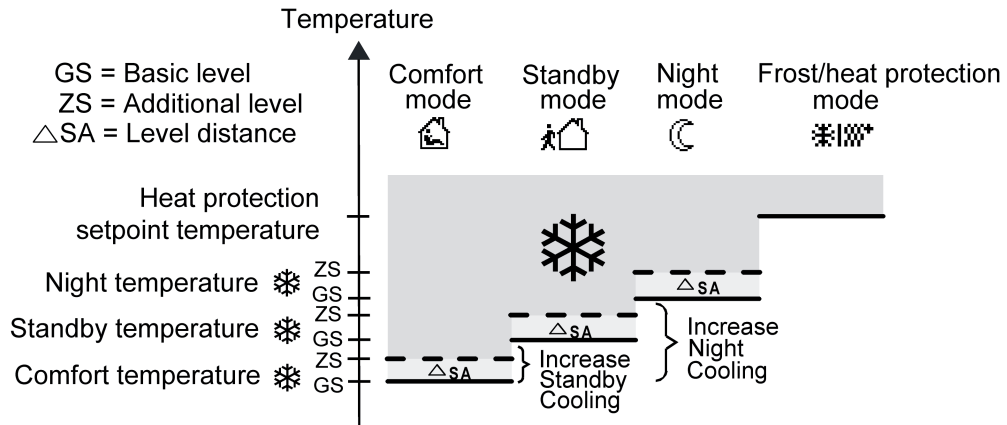

Figure 45: Setpoint temperatures in the operating mode "Basic and additional cooling"

$$T_{\text{Comfort setpoint basic level heating}} \leq T_{\text{Comfort setpoint additional level heating}}$$

$$T_{\text{Standby setpoint basic level heating}} \leq T_{\text{Standby setpoint additional level heating}}$$

$$T_{\text{Comfort setpoint cooling}} \leq T_{\text{Standby setpoint cooling}}$$

or

$$T_{\text{Comfort setpoint basic level heating}} \leq T_{\text{Comfort setpoint additional level heating}}$$

$$T_{\text{Night setpoint basic level heating}} \leq T_{\text{Night setpoint additional level heating}}$$

$$T_{\text{Comfort setpoint cooling}} \leq T_{\text{Night setpoint cooling}}$$

Setpoints for the "heating and cooling" operating mode

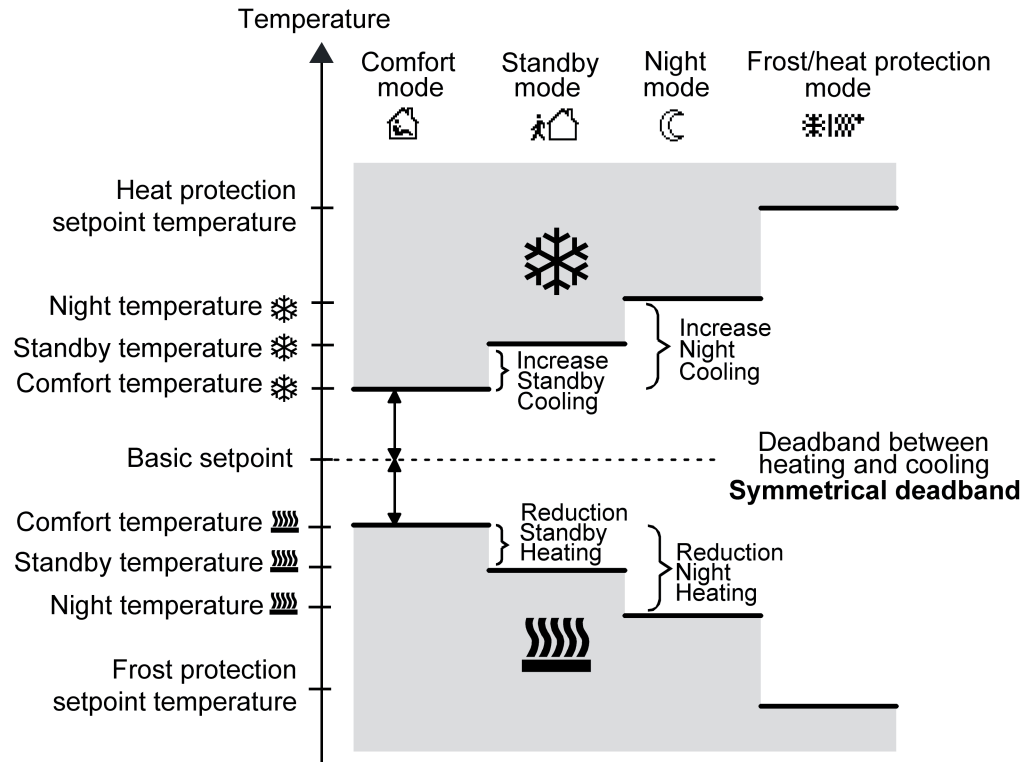

Figure 46: Setpoint temperatures in the operating mode "Heating and cooling" with symmetrical deadband

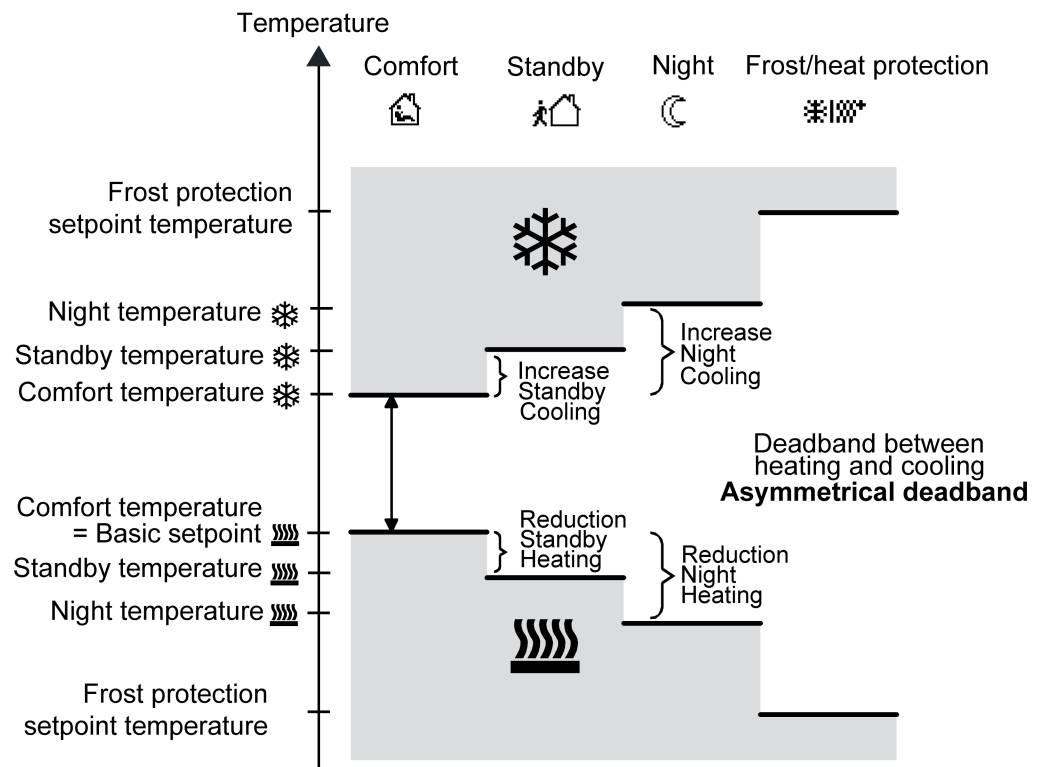

Figure 47: Setpoint temperatures in the operating mode "Heating and cooling" with asymmetrical deadband

For this heating/cooling operating mode, the setpoint temperatures of both heating/cooling modes exist for the Comfort, Standby and Night operating modes as well as the deadband. A distinction is made in the deadband position with combined heating and cooling. A symmetrical (Figure 46) or an asymmetrical (Figure 47) deadband position can be configured. In addition, the frost protection and the heat protection temperatures can be preset. The following applies...

$$T_{\text{Standby setpoint heating}} \leq T_{\text{Comfort setpoint heating}} \leq T_{\text{Comfort setpoint cooling}} \leq T_{\text{Standby setpoint cooling}}$$

or

$$T_{\text{Night setpoint heating}} \leq T_{\text{Comfort setpoint heating}} \leq T_{\text{Comfort setpoint cooling}} \leq T_{\text{Night setpoint cooling}}$$

The set-temperatures for "Standby" and "Night" are derived from the comfort setpoint temperatures for heating or cooling. The temperature increase (for cooling) and the temperature decrease (for heating) of both operating modes can be preset in ETS. The comfort temperatures itself are derived from the deadband and the basic setpoint. It is also possible to adjust other decrease or increase temperatures directly via local control in the configuration menu, if enabled in the ETS, by changing the setpoint temperature values for Night and Standby mode. The frost protection is supposed to prevent the heating system from freezing. For this reason the frost protection temperature (default: +7 °C) should be set to a smaller value than the night temperature for heating. In principle, however, it is possible to select frost protection temperature values between +7.0 °C and +40.0 °C. The heat protection is supposed to prevent the temperature from exceeding the maximum permissible room temperature in order to protect system components. For this reason the heat protection temperature (default: +35 °C) should be set to a larger value than the night temperature for cooling. In principle, however, it is possible to select heat protection temperature values between +7.0 °C and +45.0 °C. The possible range of values for a setpoint temperature ("heating and cooling") lies between +7.0 °C and +45.0 °C and is bounded by the frost protection temperature in the lower range and by the heat protection temperature in the upper range.

The level offset configured in ETS will be additionally considered in a two-level heating or cooling mode.

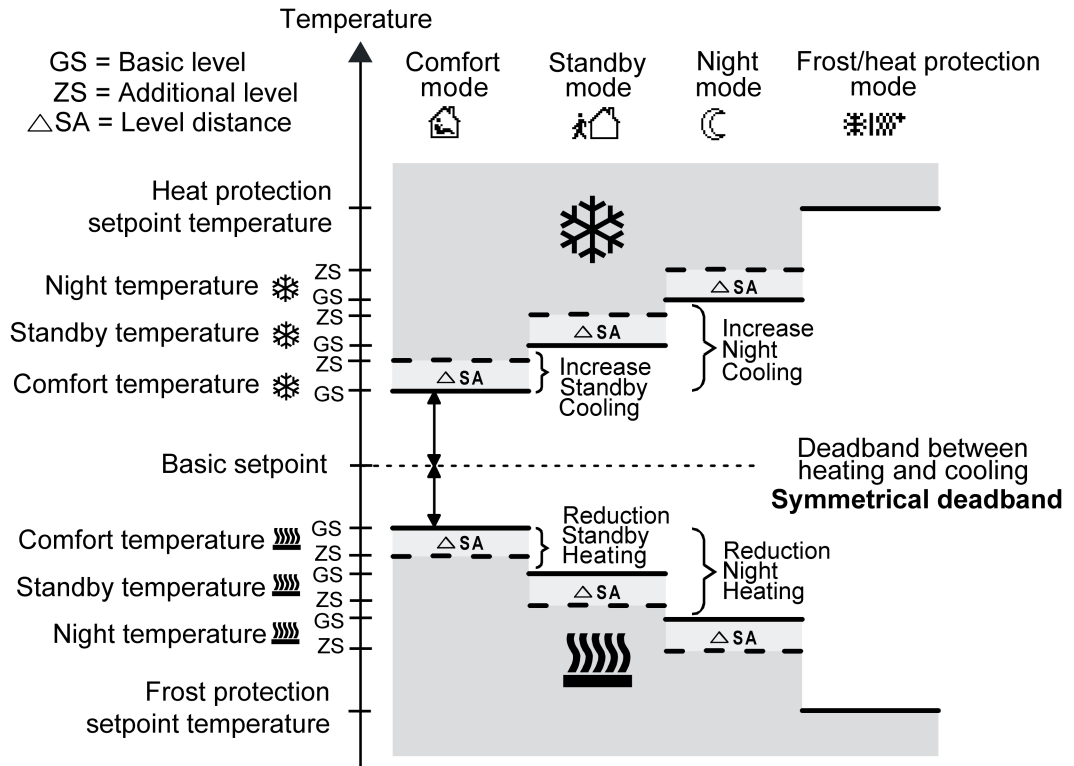

Figure 48: Setpoint temperatures in the operating mode "Basic and additional heating and cooling" with symmetrical deadband

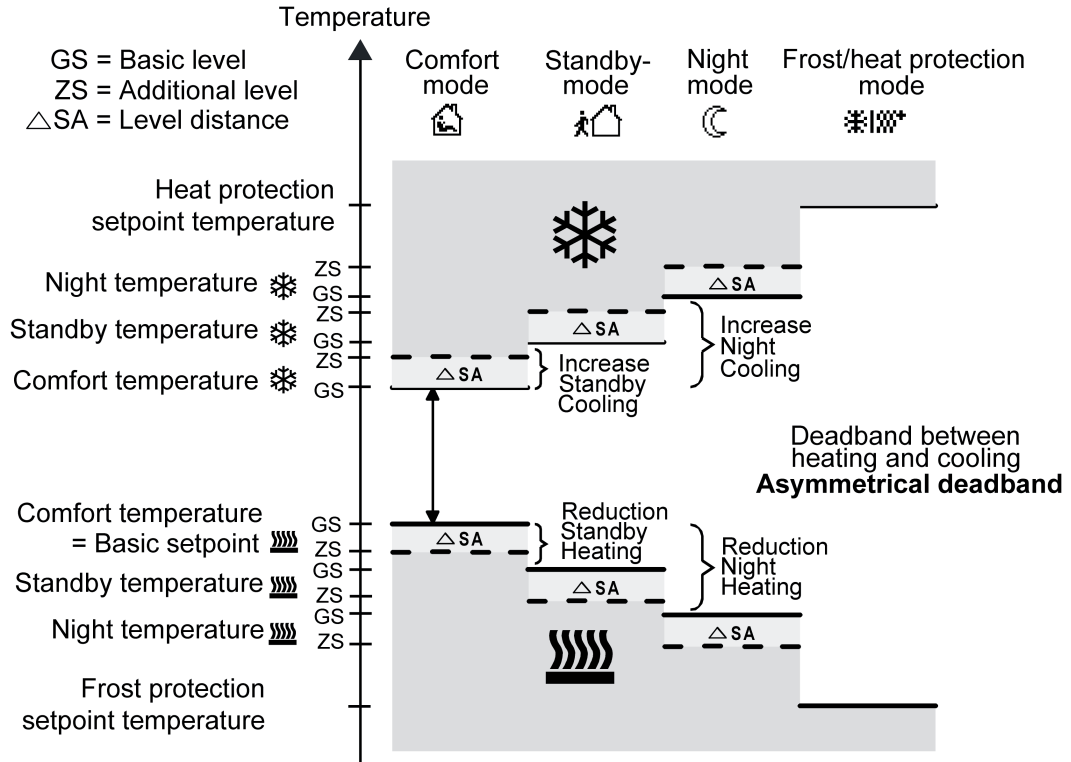

Figure 49: Setpoint temperatures in the operating mode "Basic and additional heating and cooling" with asymmetrical deadband

$$T_{\text{Comfort setpoint add. level Heating}} \leq T_{\text{Comfort setpoint basic level Heating}} \leq T_{\text{Comfort setpoint basic level Cooling}} \leq T_{\text{Comfort setpoint add. level Cooling}}$$

$$T_{\text{Standby setpoint add. level Heating}} \leq T_{\text{Standby setpoint basic level Heating}} \leq T_{\text{Standby setpoint basic level Cooling}} \leq T_{\text{Standby setpoint add. level Cooling}}$$

$$T_{\text{Standby setpoint heating}} \leq T_{\text{Comfort setpoint heating}} \leq T_{\text{Comfort setpoint cooling}} \leq T_{\text{Standby setpoint cooling}}$$

OR

$$T_{\text{Comfort setpoint add. level Heating}} \leq T_{\text{Comfort setpoint basic level Heating}} \leq T_{\text{Comfort setpoint basic level Cooling}} \leq T_{\text{Comfort setpoint add. level Cooling}}$$

$$T_{\text{Night setpoint add. level Heating}} \leq T_{\text{Night setpoint basic level Heating}} \leq T_{\text{Night setpoint basic level Cooling}} \leq T_{\text{Night setpoint add. level Cooling}}$$

$$T_{\text{Night setpoint heating}} \leq T_{\text{Comfort setpoint heating}} \leq T_{\text{Comfort setpoint cooling}} \leq T_{\text{Night setpoint cooling}}$$

deadband and deadband positions in the combined heating and cooling operating mode

With relative setpoint presetting, the comfort setpoint temperatures for heating and cooling are derived from the basic setpoint in consideration of the adjusted Dead band. The deadband (temperature zone for which there is neither heating nor cooling) is the difference between the comfort setpoint temperatures. This deadband does not exist for absolute setpoint presetting.

The "deadband between heating and cooling", "deadband position" parameters as well as the "Basic temperature after reset" parameter are preset in the ETS configuration. One distinguishes between the following settings...

- deadband = "symmetrical"

The deadband preset in the ETS is divided into two parts at the basic setpoint. The comfort setpoint temperatures are derived directly from the basic setpoint resulting from the half deadband.

The following applies...

$$T_{\text{Basic setpoint}} - \frac{1}{2}T_{\text{deadband}} = T_{\text{Comfort heating setpoint}}$$

and

$$T_{\text{Basic setpoint}} + \frac{1}{2}T_{\text{deadband}} = T_{\text{Comfort setpoint cooling}}$$

-> $T_{\text{Comfort cooling setpoint}} - T_{\text{Comfort heating setpoint}} = T_{\text{deadband}}$

-> $T_{\text{Comfort cooling setpoint}} \geq T_{\text{Comfort heating setpoint}}$

- deadband position = "Asymmetrical"

With this setting the comfort setpoint temperature for heating equals the basic setpoint. The deadband preset in the ETS is effective only from the basic setpoint in the direction of comfort temperature for cooling. Thus the comfort set-temperature for cooling is derived directly from the comfort setpoint for heating.

The following applies...

$$T_{\text{Basic setpoint}} = T_{\text{Comfort heating setpoint}}$$

-> $T_{\text{Basic setpoint}} + T_{\text{deadband}} = T_{\text{Comfort cooling setpoint}}$

-> $T_{\text{Comfort cooling setpoint}} - T_{\text{Comfort heating setpoint}} = T_{\text{deadband}}$

-> $T_{\text{Comfort cooling setpoint}} \geq T_{\text{Comfort heating setpoint}}$

Accept setpoints permanently

One has to distinguish between two cases, defined by the "Permanently apply change to basic temperature setpoint" parameter (for relative setpoint presetting), or the "Accept modification of the setpoint permanently" parameter (for absolute setpoint presetting), if the setpoint temperatures have been changed via the "Basic setpoint" or "Setpoint active operating mode" communication objects, or also via a change in the communication menu...

- Case 1: The setpoint adjustment is permanently accepted ("Yes" setting):
If, with this setting, the temperature setpoint is adjusted, the controller saves the value permanently to the EEPROM (permanent storage). The newly adjusted value will overwrite the initial value, i.e. the basic temperature originally configured via the ETS after a reset or the absolute setpoint temperature loaded using the ETS. The changed values are also retained after a device reset, after a switchover of the operating mode or after a switchover of the heating/cooling mode (with absolute setpoint specification individually for each operating mode for heating and cooling).
With this setting, it should be noted that frequent changing of the basic temperature (e.g. several times a day because of cyclical telegrams) can affect the product life of the device as the non-volatile storage is designed for less frequent write access.
The "Basic setpoint" object (relative setpoint presetting) is not bidirectional, meaning that a basic setpoint changed by local control or a shifted basic setpoint is not signalled back to the KNX/EIB. The object "Setpoint active operating mode" (absolute setpoint presetting) can be bidirectional if necessary (set "Transmit" flag!). This makes it possible to use this object to feedback to the bus the setpoint temperature resulting from a setpoint shift.
 - Case 2: The basic setpoint adjustment is only temporarily accepted ("No" setting):
The setpoints set on the room temperature controller or received via the objects remain active only temporarily. In case of a bus voltage failure, after a switchover to another operating mode (e.g. Comfort to Standby, or also Comfort to Comfort), or after a switchover of the heating/cooling mode (e.g. Heating to Cooling), the last setpoint changed will be discarded and replaced by the initial value.
- i** If the setpoint is accepted on a non-temporary basis ("Yes" setting), the setpoints restored after a device reset are not effected immediately in the communication objects. Only after the telegrams have been received from the bus via the objects and the room temperature controller accepts the newly received setpoint can the objects be read out, for example for visualisation purposes (Set "Read" flag!).
- i** With relative setpoint presetting: Independent of the "Permanently apply change to basic temperature setpoint" parameter, the temperature setpoints for the standby or night mode or "cooling" comfort mode (deadband) will always be stored in the non-volatile EEPROM memory.
With absolute setpoint presetting: As described, dependent on the "Accept modification of the setpoint permanently" parameter, the temperature setpoints for the standby or night mode for heating or cooling will always be stored in the volatile or non-volatile memory.

Basic setpoint shift for relative setpoint presetting

In addition to the specification of individual temperature setpoints via the ETS, with relative setpoint specification, the user is able to shift the basic setpoint within a settable range via the second operating level or via the basic setpoint object with the display buttons or with the "Controller operation - Setpoint shift" button function, if this is configured to a function button of the push-button sensor. Each time a button is pressed, the basic setpoint is shifted upwards or downwards by one level (depending on the button operation and parameterisation). Hold the button down for continuous shifting. The value of a level is dependent upon the application program used. With Version 1.2 applications, the step width can be configured in the ETS using the parameter "Step width of the setpoint shift" in the parameter node "Room temperature

control (RTR) -> Controller general -> Setpoints" (0.1 K / 0.5 K / 1.0 K). In Version 1.1 applications, the step width is permanently defined as 0.1 K.

- i** No basic setpoint shift can be performed if the controller is configured for absolute setpoint presetting. In this case you can use simple setpoint shifting (see page 149-150).

When a 2-area display is configured, the push-button sensor indicates a basic setpoint shift using the  icon. This icon lights up if a basic setpoint shift in the positive or negative direction has been set on the controller. In addition to displaying the icon, the push-button sensor indicates the setpoint shift in the "Setpoint" menu (see page 18-19). How it is shown there depends on the parameter setting in the ETS: either with a temperature value (absolute depiction) or using a bar graph (relative depiction). If the basic setpoint shift is depicted in the form of a bar graph, the shift is also visible in the normal display (see page 182).

- i** It has to be considered that a shift of the displayed setpoint temperature (temperature offset of the basic temperature) will directly affect the basic setpoint and as a result shift all other temperature setpoints.
A positive shift is possible up to the configured heat protection temperature. A negative shift is possible up to the set frost protection temperature.
- i** The "Basic setpoint" object is not bidirectional, meaning that a basic setpoint changed by local control or a shifted basic setpoint is not signalled back to the KNX/EIB.

Whether a basic setpoint shifting only affects the currently active operating mode or whether it influences all other set-temperatures of the remaining operating modes is determined by the "Permanently apply change to basic setpoint shift" parameter in the "Room temperature control -> Controller general -> Setpoints" parameter page...

- "No" setting:
The basic setpoint shifting carried out is in effect for only as long as the operating mode or heating/cooling mode has not changed or the basic setpoint is maintained. Otherwise the setpoint shift will be reset to "0".
- Setting "yes":
In general, the shifting of the basic setpoint carried out affects all operating modes. The shift is maintained even after switchover the operating mode or the heating/cooling mode or readjusting the basic setpoint.
- i** Since the value for the basic setpoint shift is stored exclusively in volatile memory (RAM), the shift will get lost in case of a reset (e.g. bus voltage failure).
- i** In case of two control circuits (also with separate setpoints), the set-temperatures of both circuits will be shifted.
- i** A setpoint shift does not affect the temperature setpoints for frost or heat protection!

Communication objects for the basic setpoint shift:

The controller tracks the current setpoint shift in the communication object "Current setpoint shift" via the controller with a 1-byte counter value (acc. to KNX DPT 6.010 – representation of positive and negative values in a double complement). By connecting to this object the controller extensions are also able to display the current setpoint shift. As soon as there is an adjustment by one increment in positive direction, the controller counts up the value. The counter value will be counted down if there is a negative adjustment of the level. A value of "0"

means that no setpoint shifting has been adjusted.

Example:

Starting situation: current setpoint temperature = 21.0 °C / step width of the setpoint shift = 0.5 K / counter value in "Acknowledge setpoint shift" = "0" (no active setpoint shift)

After the setpoint shifting:

-> A setpoint shift by one temperature increment in the positive direction will count up the value in the "Current setpoint shift" object by one = "1".

-> Current setpoint temperature = 21.5°C

-> An additional setpoint shift by one temperature increment in the positive direction will again count up the value in the "Current setpoint shift" object by one = "2".

-> Current setpoint temperature = 22.0°C

-> A setpoint shift by one temperature increment in the negative direction will count down the value in the "Current setpoint shift" object by one = "1".

-> Current setpoint temperature = 21.5°C

-> An additional setpoint shift by one temperature increment in the negative direction will again count down the value in the "Current setpoint shift" object by one = "0".

-> Current setpoint temperature = 21.0°C

-> An additional setpoint shift by one temperature increment in the negative direction will again count down the value in the "Current setpoint shift" object by one = "-1".

-> Current setpoint temperature = 20.5°C, etc. ...

In addition, the controller's setpoint shift can be externally adjusted via the communication object "Preset setpoint shift". This object has the same data point type and range of values as the object "Current setpoint offset" (see above). By connecting to the "Setpoint shift specification" object the controller extensions are able to directly adjust the current setpoint shift of the controller. As soon as the controller receives a value, it will adjust the setpoint shift correspondingly. Values that lie within the possible value range of the basic setpoint shift can be directly jumped to.

The controller monitors the received value independently. As soon as the external preset value exceeds the limits of the adjustment options for the setpoint shift in positive or negative direction, the controller will correct the received value and adjust the setpoint shift to maximum. Depending on the direction of the shift, the value feedback is set to the maximum value via the communication object "Current setpoint shift".

- i** In order for controller extensions to display correct shifts and also to activate the functions of the main controller correctly, it is necessary for the controller extension to be set to the same shifting limits for the setpoint shift as the main controller (see page 166-167)! Controller extensions must always work with the same step width as the controller.

Setpoint shift with absolute setpoint presetting

In addition to the setting of individual temperature setpoints via the ETS or via the setpoint object, with absolute setpoint specification the user is also able to shift the setpoint via the basic setpoint object with the display buttons or with the "Controller operation - Setpoint shift" button function, if this is configured to a function button of the push-button sensor. Each time a button is pressed, the setpoint is shifted upwards or downwards by one level (depending on the button operation and configuration). Hold the button down for continuous shifting. The value of a level is dependent upon the application program used. With Version 1.2 applications, the step width can be configured in the ETS using the parameter "Step width of the setpoint shift" in the parameter node "Room temperature control (RTR) -> Controller general -> Setpoints" (0.1 K / 0.5 K / 1.0 K). In Version 1.1 applications, the step width is permanently defined as 0.1 K.

With absolute setpoint presetting the setpoint shift directly affects the object "Setpoint active operating mode" and thus directly only the specified setpoint temperature of the specific active operating mode. The last setpoint temperature specified via the bus or by the ETS is first

overwritten by a shift. If the "Accept modification of the setpoint value permanently" parameter is set to "Yes", the controller saves the shifted temperature value in non-volatile memory (EEPROM). Otherwise (setting "No") the shifted setpoint remains active only temporarily for the active operating mode. It sets itself back to the initial value if the operating mode or the heating/cooling mode is switched over or a device reset is performed.

The setpoint temperatures of other operating modes for heating or cooling are not affected by the shifting of the setpoint of a specific operating mode. If, for example, the setpoint temperature for the comfort mode for heating is shifted, the other setpoints for night or standby mode for heating and cooling remain unchanged. If a shift is desired here, too, then the temperature values must be shifted individually.

- i** In the case of relative setpoint presetting, shifting of the basic setpoint is possible (see page 147). If accepted on a non-temporary basis this has an effect on all operating modes of the controller, and thus differs from the setpoint shift for absolute setpoint presetting.
- i** The object "Setpoint active operating mode" can be bidirectional if necessary (set "Transmit" flag!). This makes it possible to use this object to feedback to the bus the setpoint temperature of an operating mode resulting from a setpoint shift.
- i** In case of two control circuits (also with separate setpoints), the set-temperatures of both circuits will be shifted.
- i** A setpoint shift does not affect the temperature setpoints for frost or heat protection!

In the case of absolute setpoint presetting, a setpoint shift can only be performed on main controllers. A "setpoint shift" is only available on a control extension if the main controller is working with relative setpoint presetting (basic setpoint). In the case of an absolute setpoint shift on the main controller, the setpoint shift on the controller extension has no effect. In this case controller extensions can forward setpoints to main controllers, for example by pressing a function button (Temperature value transmitter to the "Setpoint active operating mode" object).

- i** Unlike the basic setpoint shift with relative setpoint presetting, a setpoint shift with absolute setpoint presetting is not depicted with any particular icon in the display. We recommend having the setpoint temperature depicted on the display. No bar graph display is possible, either! The latter can be configured in the ETS as a display function, but then no shift is displayed. The display buttons ("Setpoint" menu) then have no function.

Transmitting the setpoint temperature

The setpoint temperature, which is given by the active operating mode can be actively transmitted onto the bus via the 2-byte "Set temperature" object. Two of these objects are available when two control circuits are configured with separated setpoints. The "Transmission at setpoint temperature modification by..." parameter in the "Room temperature control -> controller general -> setpoint values" parameter node determines the temperature value by which the setpoint has to change in order to have the setpoint temperature value transmitted automatically via the object. Possible temperature value changes lie within a range of 0.1 K and 25.5 K. The setting "0" at this point will deactivate the automatic transmission of the setpoint temperature.

In addition, the setpoint can be transmitted periodically. The "Cyclical transmission of setpoint temperature" parameter determines the cycle time (1 to 255 minutes). The value "0" will deactivate the periodical transmission of the setpoint temperature value. It has to be pointed out that with deactivated periodical transmission and deactivated automatic transmission, no setpoint temperature telegrams will be transmitted in case of a change.

Setting the "Read" flag on the "Setpoint temperature" object makes it possible to read out the current setpoint. Following the return of bus voltage or after re-programming via the ETS, the object value will be initialised according to the current setpoint temperature value and actively

transmitted to the bus.

4.2.4.2.6 Room temperature measurement

Basic principles

The room temperature regulator periodically measures the actual temperature of the room and compares it with the given setpoint temperature of the active operating mode. The control algorithm calculates the adjusted command value from the difference between actual and setpoint temperatures. In order to ensure a fault-free and effective room temperature control, it is very important to determine the exact actual temperature.

The room temperature controller possesses an integrated temperature sensor, using which the room temperature can be detected. Alternatively (e.g. if the room temperature controller has been installed in an unfavourable location or operates in difficult conditions, for example, in a moist atmosphere) or in addition (e.g. in large rooms or halls), a second temperature sensor linked via bus telegrams can be used to determine the actual value. This second sensor can either be a room temperature controller coupled via the KNX/EIB or a controller extension with temperature detection. Alternatively, it is possible to connect a wired remote sensor directly to the bus coupling unit of the device.

When choosing the installation location of the controller or the external sensors, the following points should be considered...

- The controller or temperature sensor should not be used in multiple combinations, especially together with flush-mounted dimmers.
- Do not install the temperature sensor in the area of large electrical consumers (avoid heat influences).
- The push button sensor should not be installed in the vicinity of radiators or cooling systems.
- The temperature sensor should not be exposed to direct sun.
- The installation of sensors on the inside of an outside wall might have a negative impact on the temperature measurement.
- Temperature sensors should be installed at least 30 cm away from doors, windows or ventilation units and at least 1.5 m above the floor.

i Room temperature measurement by the device is always active, irrespective of the "Room temperature control" or "Controller extension" functions and can thus be used independently (e.g. for simple measurement and indication of a room temperature without feedback control).

Temperature detection and measured value formation

The "Temperature detection" parameter in the "Room temperature control -> Controller general -> Room temperature measurement" parameter node specifies the sensors to detect the room temperature. In the case to two control circuits the temperature detection of the two circuits can be configured to the various temperature sources independently of each other using separate parameters. In this manner, temperature detection of the control circuits can be either different or the same.

The following settings are possible for temperature detection

- "internal sensor"
The temperature sensor integrated in the room temperature controller is activated. Thus, the actual temperature value is determined only locally on the device.
In this configuration, the feedback control will start directly after a device reset.

- "external sensor"
 The actual temperature is determined solely via the wired remote sensor connected to the flush-mounted bus coupling unit (see Accessories). If necessary its measured temperature value can if necessary be transmitted to the bus or read out via the 2-byte object "External sensor".
 In this configuration, the feedback control will start directly after a device reset. It is important for a wired remote sensor to be connected!

 - "received temperature value"
 The actual temperature is determined solely via a temperature value received from the bus. In this case, the sensor must either be a KNX/EIB room thermostat coupled via the 2-byte object "Received temperature" or a controller extension with temperature detection. The room temperature controller can request the current temperature value cyclically. For this purpose, the parameter "Request time of the received temperature value" must be set to a value > "0". The request interval can be configured within the limits of 1 minute to 255 minutes.
 After a device reset the room temperature controller will first wait for a valid temperature telegram until the feedback control starts and a command value, if applicable, is output.

 - "Internal and external sensor" or "Internal sensor + received temperature value" or "External sensor + received temperature value"
 These settings are used to combine the selected temperature sources. The sensors can be either a remote sensor wired directly to the controller, or KNX/EIB room thermostats connected via the 2-byte object "Received temperature", or controller extensions with temperature detection.
 When the wired remote sensor (external sensor) is used, its insulated measured temperature value can if necessary be transmitted to the bus or read out via the 2-byte object "External sensor". With the setting "Received temperature value" the room temperature controller can request the current temperature value cyclically. For this purpose, the parameter "Request time of the received temperature value" must be set to a value > "0". The request interval can be configured within the limits of 1 minute to 255 minutes. After a device reset the room temperature controller will first wait for a valid temperature telegram until the feedback control starts and a command value, if applicable, is output.
 When evaluating, the real actual temperature is made up from the two respective measured temperature values. The weighting of the temperature values is defined by the parameters "Creation of measuring value internal against external" and "Creation of measuring value to be received externally". Depending on the different locations of the sensors or a possible non-uniform heat distribution inside the room, it is thus possible to adjust the actual temperature measurement. Often, those temperature sensors that are subject to negative external influences (for example, unfavourable location because of exposure to sun or heater or door / window directly next to it) are weighted less heavily.
- Example: a room temperature controller is installed next to the entrance to the room (internal sensor). An additional wired temperature sensor has been mounted on an inner wall in the middle of the room below the ceiling.
 Internal sensor: 21.5 °C
 External sensor: 22.3 °C
 Determination of measured value: 30 % to 70 %
- > $T_{\text{Result internal}} = T_{\text{internal}} \cdot 0.3 = 6.45 \text{ °C}$,
 -> $T_{\text{Result external}} = T_{\text{external}} \cdot 0.7 = 15.61 \text{ °C}$
 -> $T_{\text{Result actual}} = T_{\text{Result internal}} + T_{\text{Result external}} = \underline{22.06 \text{ °C}}$

Calibrating the measured values

In some cases during room temperature measurement, it may be necessary to adjust the single temperature values. Adjustment becomes necessary, for example, if the temperature measured by the sensors stays permanently below or above the actual temperature in the vicinity of the sensor. To determine the temperature deviation, the actual room temperature should be detected with a reference measurement using a calibrated temperature measuring device. The parameters "Internal sensor calibration", "External sensor calibration" and "Received temperature value calibration" in the "Room temperature control -> Controller general -> Room temperature measurement" parameter node can be used to parameterise the positive (temperature increase, factors: 1 ... 127) or negative (temperature decrease, factors -128... -1) temperature calibration in levels of 0.1 K. Thus, the calibration is made only once statically and is the same for all operating modes of the controller.

- i** The measured value has to be increased, if the value measured by the sensor lies below the actual room temperature. The measured value has to be decreased, if the value measured by the sensor lies above the actual room temperature.
- i** During room temperature control, the controller always uses the adjusted temperature value to calculate the command values. The adjusted temperature value is transmitted to the bus via the "Actual temperature" object (see "Transmission of the actual temperature"). When determining the measured value using combined sensors, the two adjusted values are used to calculate the actual value.

Transmission of the actual temperature

The determined actual temperature of the first control circuit can be actively transmitted to the bus via the 2-byte "Actual temperature" object. The parameter "Transmission when room temperature change by..." parameter in the "Room temperature control -> Controller general -> Room temperature measurement" parameter node specifies the temperature value by which the actual value has to change in order to have the actual temperature value transmitted automatically via the object. Possible temperature value changes lie within a range of 0.1 K and 25.5 K. Setting to "0" at this point will deactivate the automatic transmission of the actual temperature.

In addition, the actual value of the first control circuit can be transmitted periodically. The "Cyclical transmission of the room temperature" parameter determines the cycle time (1 to 255 minutes). The value "0" will deactivate the periodical transmission of the actual temperature value.

Setting the "Read" flag on the "actual temperature" object makes it possible to read out the current actual value at any time over the bus. It has to be pointed out that with deactivated periodical transmission and deactivated automatic transmission, no more actual-temperature telegrams will be transmitted".

- i** When two control circuits are used, the actual temperature of the second circuit cannot be transmitted to the bus as described for the first control circuit.

Following the return of bus voltage, new programming via the ETS, the object value will be updated according to the actual temperature value and transmitted on the bus. During room temperature control, the controller always uses the adjusted temperature value to calculate the command values. The adjusted temperature value is transmitted to the bus via the "Actual temperature" object.

4.2.4.2.7 Command value and status output

Command value objects

The format of the command value objects are determined depending on the control algorithm selected for heating and / or cooling and, if applicable, also for the additional levels. 1 bit or 1 byte command value objects can be created in the ETS. The control algorithm calculates the command values in intervals of 30 seconds and outputs them via the objects. With the pulse width modulated PI control (PWM) the command value is updated, if required, solely at the end of a time cycle.

Possible object data formats for the command values separately for both heating/cooling operating modes, for the basic and the additional level or for both control circuits are...

- continuous PI control: 1 byte
- Switching PI control: 1 bit + additionally 1 byte (for example for the status indication with visualisations),
- switching 2-point feedback control: 1 bit.

Depending on the selected heating/cooling operating mode, the controller is able to address heating and / or cooling systems, to determine command values and to output them via separate objects. One distinguishes between two cases for the "Heating and cooling" mixed operating mode...

- Case 1: Heating and cooling system are two separate systems
In this case the "Transmit heating and cooling command value to one common object" parameter should be set to "No" in the "Room temperature control -> Controller functions" parameter node. Thus, there are separate objects available for each command value, which can be separately addressed via the individual systems.
This setting allows to define separate types of control for heating and cooling.
- Case 2: Heating and cooling system are a combined system
In this case the "Transmit heating and cooling command value to one common object" parameter may be set, if required, to "Yes". This will transmit the command values for heating and cooling to the same object. In case of a two-level feedback control, another shared object will be enabled for the additional levels for heating and cooling.
With this setting it is only possible to define the same type of feedback control for heating and for cooling as the feedback control and the data format must be identical. The ("Type of heating / cooling") control parameter for cooling and heating still has to be defined separately.
A combined command value object may be required, for example, if heating as well as cooling shall take place via a single-pipe system (combined heating and cooling system). For this, the temperature of the medium in the single-pipe system must be changed via the system control. Afterwards the heating/cooling operating mode is set via the object (often the single-pipe system uses cold water for cooling during the summer, hot water for heating during the winter).

If required, the command value can be inverted before the transmission to the KNX/EIB. With output via a combined object, the parameters "Output of heating command value", "Output of cooling command value" or "Output of command values..." output the command value in inverted fashion according to the object data format. The parameters for inverting the additional level(s) are additionally available in the two-level control.

The following applies...

For continuous command values:

-> not inverted: Command value 0 % ... 100 %, value 0 ... 255

-> inverted: Command value 0 % ... 100 %, value 255 ... 0

For switching command values:

-> not inverted: Command value off / on, value 0 / 1

-> inverted: Command value off / on, value 1 / 0

Automatic transmission

On automatic transmission of the command value telegrams, a distinction is made with regard to the type of control...

- **Continuous PI control:**
In case of a continuous PI control, the room temperature controller calculates a new command value periodically every 30 seconds and outputs it to the bus via a 1-byte value object. The change interval of the command value can be determined in percent according to which a new command value is to be output on the bus via the "Automatic transmission on change by..." parameter in the "Room temperature control -> Controller general -> Command values and status output" parameter node. The change interval can be configured to "0" so that a change in the command value will not result in an automatic transmission.
In addition to the command value output following a change, the current command value value may be periodically transmitted on the bus. In addition to the times when changes are to be expected, other command value telegrams will be output according to the active value after a configurable cycle time. This ensures that, during cyclical security monitoring of the command value in the servo drive or in the activated switch actuator, telegrams are received within the control interval. The time interval predetermined by the "Cycle time for automatic transmission..." parameter should correspond to the control interval in the actuator (cycle time in the controller is preferably to be configured smaller). The "0" setting will deactivate the periodic transmission of the command value.
With continuous PI control it must be noted that if the cyclical and the automatic transmission are both deactivated, no command value telegrams will be transmitted in case of a change!

- **Switching PI control (PWM):**
In case of a switching PI control (PWM), the room temperature controller calculates a new command value internally every 30 seconds. In this feedback control, however, the update of the command value takes place, if required, solely at the end of a PWM cycle. The parameters "automatic transmission on change by..." and "Cycle time for automatic transmission..." are not enabled with this control algorithm. The parameter "Cycle time of the switching command value..." defines the cycle time of the PWM command value signal.

- **2-point feedback control:**
In case of a 2-point feedback control, the room temperature and thus the hysteresis values are evaluated periodically every 30 seconds, so that the command values, if required, will change solely during these times. The "Automatic transmission on change by..." parameter is not enabled as this control algorithm does not calculate continuous command values.
In addition to the command value output following a change, the current command value value may be periodically transmitted on the bus. In addition to the times when changes are to be expected, other command value telegrams will be output according to the active value after a configurable cycle time. This ensures that, during cyclical security monitoring of the command value in the servo drive or in the activated switch actuator, telegrams are received within the control interval. The time interval predetermined by the "Cycle time for automatic transmission..." parameter should correspond to the control interval in the actuator (cycle time in the controller is preferably to be configured smaller). The "0" setting will deactivate the periodic transmission of the command value.

Controller status

The room temperature controller can transmit its current status to the KNX/EIB. A choice of data formats is available for this. The "Controller status" parameter in the "Room temperature control -> Controller general -> Command value and status output" parameter branch will enable the status signal and set the status format...

- "KNX compliant"
The KNX compliant controller status feedback is harmonised on a manufacturer-specific basis, and consists of 3 communication objects. The 2-byte object "KNX status" (DPT 22.101) indicates elementary functions of the controller (see Table 7). This object is supplemented by the two 1-byte objects "KNX status operating mode" and "KNX status forced operating mode" (DPT 20.102), which report back the operating mode actually set on the controller (see page 127). The last two objects mentioned above are generally used to enable controller extensions to display the controller operating mode correctly in the KNX compliant status display. Therefore these objects should be connected with controller extensions if the KNX compliant status feedback is not configured.

Bit of the status telegram	Meaning
0	Controller error status ("0" = no error / "1" = error)
1	not used (permanent "0")
2	not used (permanent "0")
3	not used (permanent "0")
4	not used (permanent "0")
5	not used (permanent "0")
6	not used (permanent "0")
7	not used (permanent "0")
8	Operating mode ("0" = Cooling / "1" = Heating)
9	not used (permanent "0")
10	not used (permanent "0")
11	not used (permanent "0")
12	Controller disabled (dew point operation) ("0" = Controller enabled / "1" = Controller disabled)
13	Frost alarm ("0" = Frost protection temperature exceeded / "1" = frost protection temperature undershot)
14	Heat alarm ("0" = heat protection temperature exceeded / "1" = Heat protection temperature exceeded)
15	not used (permanent "0")

Table 7: Bit encoding of the 2 byte KNX compliant status telegram







- "Controller general":
The general controller status collects essential status information of the controller in two 1-byte communication objects. The "Controller status" object contains fundamental status information (see Table 8). The "Status signal addition" object collects in a bit-orientated manner further information that is not available via the "Controller status" object (see Table 9). For example, controller extensions can evaluate the additional status information, in order to be able to display all the necessary controller status information on the extension display.

Bit of the status telegram	Meaning
0	On "1": Comfort operation activated
1	On "1": Standby mode active
2	On "1": Night mode active
3	On "1": Frost/heat protection mode active
4	On "1": Controller disabled
5	On "1": Heating, on "0": Cooling
6	On "1": Controller inactive (deadband)
7	On "1": Frost alarm ($T_{\text{Room}} \leq +5 \text{ }^{\circ}\text{C}$)

Table 8: Bit encoding of the 1 byte status telegram

Bit of the status telegram	Meaning on "1"	Meaning on "0"
0	Normal operating mode	Forced operating mode
1	Comfort extension active	No comfort extension
2	Presence (Presence detector)	No presence (Presence detector)
3	Presence (Presence button)	No presence (Presence button)
4	Window opened	No window opened
5	Additional level active	Additional level inactive
6	Heat protection active	Heat protection inactive
7	Controller disabled (dew point operation)	Controller not disabled

Table 9: Bit encoding of the 1 byte additional status telegram

- "Transmit individual state"
The 1 bit status object "Controller status, ..." contains the status information selected by the "Single status" parameter. Meaning of the status signals:
 - "Comfort mode active" -> Active if operating mode "Comfort  or a comfort extension " is activated.
 - "Standby mode active" -> active if the "standby  operating mode is activated.
 - "Night-mode active" -> active if the "night  operating mode is activated.
 - "Frost/heat protection active" -> active if the "frost/heat protection   operating mode is activated.
 - "Controller disabled" -> Active if controller disable is activated  (dew point mode).
 - "Heating / cooling" -> Active if heating is activated and inactive if cooling is activated. Inactive if controller is disabled.
 - "Controller inactive" -> Active with the "heating and cooling" operating mode when the measured room temperature lies within the dead zone. This status information is always "0" for the individual "Heating" or "Cooling" operating modes. Inactive if controller is disabled.
 - "Frost alarm" -> Is active if the detected room temperature reaches or falls below +5 °C. This status signal will have no special influence on the control behaviour.

- i** Upon a reset, the status objects will be updated after the initialisation phase. After this, updating is performed cyclically every 30 seconds in parallel with the command value calculation of the controller command values. Telegrams are only transmitted to the bus when the status changes.

Command value limit

Optionally a command value limit can be configured in the ETS. The command value limit allows the restriction of calculated command values to the range limits "minimum" and "maximum". The limits are permanently set in the ETS and, if command value limitation is active, can be neither undershot or exceeded during device operation. If present, it is possible to specify various limiting values for the basic and additional levels, for the command values of both control circuits and for heating and cooling.

- i** It should be noted that the command value limit has no effect with "2-point feedback control" and with "Transmitting of command values for heating and cooling via a common object"! In that case it is still possible to configure the command value limit in the ETS, but it will have no function.

The "Command value limit" parameter on the parameter page "Room temperature control -> Controller general -> Command values and status output" defines the mode of action of the limiting function. The command value limit can either be activated or deactivated using the 1-bit communication object "Command value limit", or be permanently active. When controlling via the object, it is possible to have the controller activate the command value limit automatically after bus voltage return or an ETS programming operation. Here the "Command value limit after reset" parameter defines the initialisation behaviour. In the "Deactivated" setting, the command value limit is not automatically activated after a device reset. A "1" telegram must first be received via the "Command value limit" object for the limit to be activated. In the "Activated" setting, the controller activates the command value limit automatically after a device reset. To

deactivate the limit a "0" telegram must be received via the "Command value limit" object. The limit can be switched on or off at any time using the object.

With a permanently active command value limit, the initialisation behaviour cannot be configured separately after a device reset, as the limit is always active. In this case it is also not possible to configure any object.

As soon as the command value limit is active, calculated command values are limited according to the limiting values from the ETS. The behaviour with regard to the minimum or maximum command value is then as follows...

- **Minimum command value:**
The "Minimum command value" parameter specifies the lower command value limiting value. The setting can be made in 5 % increments in the range 5 % ... 50 %. With an active command value limit, the set minimum command value is not undershot by command values. If the controller calculates smaller command values, it sets the configured minimum command value. The controller transmits a 0% command value if no more heating or cooling energy has to be demanded.

- **Maximum command value:**
The "Maximum command value" parameter specifies the upper command value limiting value. The setting can be made in 5 % increments in the range 55 % ... 100 %. With an active command value limit, the set maximum command value is not exceeded. If the controller calculates larger command values, it sets the configured maximum command value.

If the limit is removed, the device automatically repositions the most recently calculated command value to the unlimited values when the next calculation interval for the command values (30 seconds) has elapsed.

- i** If the controller executes a valve protection function, the command value limit is temporarily deactivated in order to make use of the full motion range of the valve.
- i** An active command value limit has a negative effect on the control result when the command value range is very restricted. A control deviation must be expected.

Special case for command value 100% (Clipping mode)

If with a PI control the calculated command value of the controller exceeds the physical limits of the actuator, in other words if the calculated command value is greater than 100%, then the command value is set to the maximum value (100%) and thus limited. This special, necessary control behaviour is also called "clipping". With PI control the command value can reach the value "100%" if there is a large deviation of the room temperature from the setpoint temperature or the controller requires a long time to adjust to the setpoint with the heating or cooling energy that is being applied. The controller can evaluate this state in a particular manner and react to it in various ways.

The parameter "Behaviour with command value = 100% (clipping mode PI control)" on the parameter page "Room temperature control -> Controller general -> Command values and status output" defines the functions of the PI controller when the command value is 100%...

- "keep 100% until setpoint = actual, then 0%" setting:
The controller keeps the maximum command value until the room temperature (actual value) reaches the setpoint temperature. After that it reduces the command value down to 0% all at once (controller reset).
The advantage of this control behaviour is that in this way sustainable heating up of undercooled rooms or effective cooling of overheated rooms will be achieved by overshooting the setpoint. The disadvantage is that in some circumstances the overshooting of the room temperature may be found disturbing.

- Setting "keep 100% as required, then adjust downwards":
The controller maintains the maximum command value only as long as it is necessary. After that it adjusts the command value downwards according to the PI algorithm. The advantage of this control characteristic is the fact that the room temperature does not exceed the setpoint temperature at all, or only slightly. The disadvantage is that this control principle increases the tendency to oscillate about the setpoint.

Which of the methods of functioning described above is used often depends on what heating or cooling system is used (underfloor heating, radiators, fan coils, cooling ceilings, etc.), and how effective these systems are. We recommend selecting the setting "keep 100% until setpoint = actual, then 0%" (default setting). Only if this control behaviour has an adverse effect on the people's perception of the temperature in a room should the setting "keep 100% as required, then adjust downwards" be used.

- i** Clipping may also occur when a command value limit is active (maximum command value). In this case, if the internally calculated command value reaches 100%, then the controller only transmits to the bus the maximum command value according to the ETS configuration. The clipping (switching off when setpoint = actual or adjusting downwards) is performed, however.
- i** It should be noted that the clipping mode has no effect with "2-point feedback control"! In that case it is still possible to configure the parameter "Behaviour with command value = 100%" in the ETS, but it will have no function.

4.2.4.2.8 Disable functions of the room temperature controller

Disable controller

Certain operation conditions may require the deactivation of the room temperature control. For example, the controller can be switched-off during the dew point mode of a cooling system or during maintenance work on the heating or cooling system. The "Via object" setting in the "Switch off controller (dew point operation)" parameter in the "Room temperature control -> Controller functionality" parameter node enables the 1-bit "Disable controller" object. In addition, the controller disable function can be switched off when set to "No".

In case a "1" telegram is received via the enabled disable object, the room temperature control will be completely deactivated. In this case the command values of both control circuits are the same "0" (wait for 30 sec command value update interval) and the "Dew point operation"  icon lights up on the device display. The controller, however, can be operated in this case.

The additional stage can be separately disabled when in two-stage heating or cooling mode. When set to "Yes", the "Additional level disabling object" parameter in the "Room temperature control -> Controller general" parameter node will enable the 1 bit "Disable additional level" object. In addition, the disable function of the additional level can be switched off when set to "No". In case a "1" telegram is received via the enabled disable object, the room temperature control is completely deactivated by the additional level. The command value of the additional level is "0" while the basic level continues to operate.

In case both control circuits are used, the second control circuit can be separately disabled. In case a "1" telegram is received via the disable object "Disable 2nd control circuit", the room temperature control of the second control circuit will be deactivated and the command value of this circuit will be "0". In this case the first control circuit will continue to run.



-  A disable is always deleted after a reset (return of bus voltage, ETS programming operation).

Disable controller operation

It is possible to disable the operation of the room temperature controller. If operation is disabled, the controller can no longer be operated using function buttons of the device, display buttons or the "Settings" menu. Operation via the bus, e.g. using the operating mode or setpoint objects, is still possible, however.

An active disable of the operation will be indicated by the "  " icon on the display.

The "operation of controller inhabitable" parameter in the "Room temperature control -> Controller functionality" parameter branch can be used to determine whether the local operation is never possible (setting: "always disabled" or whether it can be initiated via the "controller operation disable" object (setting: "via bus"). With the setting "via bus" the operation will be deactivated if a "1" telegram is received on the object. Hence, the operation will be activated again after receiving a "0" telegram. Pressing a button assigned as a controller operation or display key ("Setpoint" menu) will show no response during an active disable.

-  If the controller operation is disabled, it will not influence room temperature control itself, i.e. the control algorithm is running and creating actuating variables and status reports.
-  A disable of the controller operation is always deleted after a reset.

4.2.4.2.9 Heating timer

The heating timer integrated into the device allows requirements-oriented switch-over of the controller operating mode depending on the time of day and the day of the week. For this purpose, the device provides up to 28 separate switching times that can be preconfigured individually in the ETS, and can be modified subsequently via the settings menu while the push button sensor is in operation (see page 26).

The push-button sensor has an internal clock that has to be set at least once an hour via the bus using a communication object, in order to keep the deviation as low as possible. The internal clock controls the execution of the switching times of the heating timer.

The heating timer executes the switching times at the 00 second mark of each new minute. If a switching time is edited and accepted in the menu or programmed into the device using the ETS and its timestamp corresponds to the current time, then the push-button sensor only executes the switching time on the next day if the following day of the week is taken into account in the configuration.

Example 1:

Current time 8:30 a.m. -> A switching time is edited to 8:30 a.m. and accepted. -> The push-button sensor executes the switching time only on the next day at the specified time so long as the day of the week corresponds to the switching time specifications.

When a time telegram is received via the bus, the push-button sensor evaluates its switching times again. If the new time deviates from the old one in hours or minutes, the heating timer executes switching times as long as the time corresponds to the current, newly specified time.

Example 2:

Current time 7:59 a.m. -> New time telegram 8:00 a.m. -> A switching time is defined for 8:00 a.m. The push-button sensor executes the switching time immediately after the new time specification.

Example 3:

Current time 8:01 a.m. -> New time telegram 8:00 a.m. -> A switching time is defined for 8:00 a.m. The push-button sensor executes the switching time immediately after the new time specification.

If the new time in minutes and hours is the same as the old one, the push-button sensor does not execute any switching times, because the switching time has already been executed before the time specification and the time deviation is less than 60 seconds.

Example 4:

Current time 8:00 a.m. -> New time telegram 8:00 a.m. -> No response when switching times are processed.

Before the push-button sensor is commissioned, switching times can be defined using the ETS. In order to be able to use the heating timer in general, this function must first be enabled in the parameter branch "Room temperature control -> Heating timer". After that it is possible to edit the up to 28 switching times individually.

In the ETS, a switching time is divided into 5 parameters. In order to use a switching time, the corresponding parameter "Use switching time X?" must be parameterised to "Yes" (default for switching time 1). In this case it is possible to use further parameters directly to set the time (in hours [0...23] and minutes [0...59]), the desired day of the week for execution and the required controller operating mode. Under day of the week you have the option of selecting individual days ("Monday", "Tuesday", ..., "Saturday", "Sunday"), selecting only workdays (Monday - Friday), selecting the weekend (Saturday - Sunday), or selecting the entire week (Monday - Sunday). Under controller operating mode you can set the modes "Comfort mode", "Standby mode", "Night mode" or "Frost/heat protection mode".

i It has to be pointed out that an operating mode set via the heating timer is on equal terms with a local control on the push-button sensor or via the switchover objects (4 x 1-bit, 1-byte KNX switchover object) and can be changed at any time. Functions that control the operating mode of the controller with a higher priority (e.g. window status, presence detector) are not affected by the heating timer.

- i** It is possible to configure multiple switching times to the same time and to identical days of the week. In this case, the push-button sensor only executes the switching time with the highest switching time number.

The switching programs of the timer will be loaded into the device and stored in permanent memory when the entire application program is programmed or when you are partially programming the parameters, if the ETS parameter "Overwrite switching times saved in device during download?" is set to "Yes". In this case, any switching times set locally on the device in the configuration menu of the heating timer will be overwritten permanently! Alternatively, the switching times present in the device can be left untouched during an ETS programming operation. To do this, the parameter "Overwrite switching times saved in device during download?" must be set to "no". In this case the switching times defined in the ETS have no function.

We recommend that at least during initial commissioning of the push-button sensor, you define switching times in the ETS and load them in the device.

If the heating timer is enabled in the ETS and this setting has been programmed into the device, then the heating timer is activated directly after the initialisation phase (exception: disabling function active - see below). The display shows the icon ☉. The push-button sensor then executes its switching times chronologically. For this, a valid time received from the bus and the associated day of the week are required. If no switching times are stored in the device, the icon for the heating timer will still light up on the display after a device reset, but no switching times will be executed.

- i** The internal clock of the push button should be set by an external time control signal at least every hour to keep the time error as low as possible. Unless the internal clock has been updated through the bus at least once per day (update check at 4:00 a. m.) the display of the push button will read "--:--" if the time is indicated on the display (depending on the corresponding parameter). However, the internal clock will keep running with the expected time error, and the switching programs of the heating timer will still be executed!
- i** The weekday information is provided by the time signal. The heating timer will process the programmed switching times only after receiving a valid weekday. The weekdays are not displayed on the display of the push button sensor.

Activation or deactivation of the heating timer is possible during device operation via a button function (see page 98). Alternatively, a disabling function allows the operating mode to be switched over by the heating timer, and can be activated temporarily, for example via the bus while on holiday. To facilitate the disabling function, the parameter "Disabling heating timer via bus?" in the parameter branch "Room temperature control -> Heating timer" can be set to "Yes". In this case the 1-bit object "disable heating timer" will be enabled. The polarity of this disabling object can be parameterised. During an active disable function, the operating mode will not be switched-over by the heating timer. The icon ☉ is then hidden.

If you re-enable the heating timer exactly at the moment of a configured switching time, the push-button sensor will not make up the switching program concerned. Activation or deactivation of the heating timer using a button function during the disabling phase will be stored and effected after the end of disabling.

- i** In the case of inverted polarity of the disabling object the heating timer is disabled immediately after device initialisation, and therefore inactive. To enable the heating timer a "1" telegram must be transmitted to the disabling object.
- i** The heating timer is only configurable in a main controller. The heating timer is not available in controller extensions!

4.2.4.2.10 Valve protection

Valve protection may be carried out periodically in order to prevent the addressed control valves of the heater or cooling system from becoming calcified or stuck. When set to "Yes", the "Valve protection" parameter in the "Room temperature control -> Controller functionality" parameter node activates valve protection.

This type of protection is generally started not only for non-active command value objects, i.e. for objects which have not requested any heating or cooling energy over the past 24 hours. For these objects, by taking into account the following parameterisation the controller will periodically set the command value to the maximum value once a day for a duration of approx. 5 minutes...

Command value output not inverted:

-> 1-bit command value: "1", 1-byte command value: "255"

Command value output inverted:

-> 1-bit command value: "0", 1-byte command value: "0"

Thus even long closed valves will be opened briefly on a regular basis.

- i** A controller disable has no influence on the valve protection. This means that valve protection is carried out, even when the controller is disabled.
- i** The controller checks the 24 hr time cycle for valve protection using its internal clock. With a time-synchronised clock, valve protection takes place each day at 8.00 in the morning. If the time signal has not been synchronised via the bus for a long time, then the clock continues to run with the deviation that is to be expected. This means that the valve protection time may shift continually with an unsynchronised clock.

4.2.4.3 Room temperature controller extension

The device can be used for single-room temperature control. Depending on the operating mode, the current temperature setpoint and on the room temperature, command values for heating or cooling control and fan control can be sent to the KNX/EIB. Usually, these command values are then converted by a suitable KNX/EIB actuator, e.g. heating or switching actuators or directly by bus-compatible actuating drives, evaluated and converted to physical variables for air conditioning control.

The room temperature controller is an independent function section of the device. It has its own parameter and object range in the ETS configuration. Therefore, the room temperature controller can be switched on or off, irrespective of the push button sensor function. The controller function section of the device can either work as a main controller or as a controller extension. As the main controller, the room temperature controller function is fully switched on and the control algorithm activated. Only the main controller transmits control value telegrams. A controller extension itself is not involved in the regulating process. With it, the user can operate the single-room controller, i.e. the main controller from different places in the room. In this way, any number of operating extensions can be set up.

In this chapter, the functions of the room temperature controller are described as an extension.

4.2.4.3.1 Connection to room temperature controller

Function

The controller extension function can be activated to control a KNX/EIB room temperature controller. The controller extension function is enabled using the "Controller extension" setting of the parameter "Room temperature controller function" in the "Room temperature controller" parameter node.

Typical KNX/EIB room temperature controllers generally offer different ways of influencing or visualising the room temperature control...

- Switching over between different modes of operation (e.g. "Comfort", "Night" ...) with different setpoint temperatures assigned to each mode by the thermostat.
- Signalling the presence of a person in a room. The signalling may also be combined with a configured switchover in the mode of operation.
- Readjustment of the setpoint temperature in levels which are referred in each case to the configured setpoint temperature of the current operating mode (basic setpoint shift). This function is only available on a control extension if the main controller is working with relative setpoint presetting (basic setpoint).

The controller extension is operated using the push button functions of the device ("push button sensor" function section). In this way, it is possible to completely control a room temperature controller by changing the operating mode, by predefining the presence situation or by readjusting the setpoint shift. For this purpose, the buttons of the push button sensor selected as extension operation buttons must be configured for the "Controller extension" function (see page 96).

- i** It should be noted that an extension operation is possible with a button configuration. The controller extension function must be enabled in the "Room temperature controller" parameter node. In all other cases, the controller extension function is not operational in the "push button sensor" function section.

Besides the operating function, the controller extension also possesses a display function. As on the main controller, various items of status information of the temperature controller can be shown on the device display. As the displayed states and information and also some operating functions are strongly dependent on the parameterisation of the main controller, the controller extension must also be configured and thus match the functions of the main controller. These functions are matched by parameters in the parameter node "Room temperature control" (see page 174).

In addition to the status indication on the device display, the push button sensor can indicate the state of one or more room temperature controllers with the status LEDs of the rockers or buttons. This feature permits the indication of operating modes or the evaluation of different status objects of controllers. In case of the controller extension functions "Setpoint shift" or "Presence function", the status LEDs can also signal the state of the corresponding functions directly (see page 100).

Communication objects

The controller extension can work properly only if all extension objects are linked with the objects of the same function in the room temperature controller. The controller extension with the objects exists only once in the push button sensor (indication in the object names "B.Controller extension" and "D.Input controller extension"). All button functions configured for the controller extension act on the objects belonging to the extension. Objects with the same function can be linked together using identical group addresses, meaning that multiple controller extensions can affect one main controller. Table 10 shows all the communication objects of the controller extension and explains the function and the necessary connections to the objects of the main controller. With some objects, (e. g. "Controller status") care should be taken to ensure that the data formats (Controller general, KNX compliant) agree.

Object on the Controller extension	Object on the main controller	Function / Meaning
B. Controller extension Operating mode switchover	R.Input Operating mode switchover	Change-over and transmission of the operating mode to the main controller.
B. Controller extension Operating mode	R.Input Operating mode forced-control	Change-over and transmission of the forced operating mode to the main controller.
B. Controller extension	R.Input / Output Presence object	Change-over and transmission of the presence status to the main controller. Also for activating the status LED of a presence button.

forced object		
Presence button		
B. Controller extension Setpoint shift specification	R.Input Setpoint shift specification	For setting a new counter value to adjust the setpoint for the main controller.
B. Controller extension Current	R.Output Current setpoint shift	Receiving the counter value to adjust the setpoint of the main controller.
D.Input controller extension KNX status operating mode	R.Output KNX status operating mode	For evaluation and indication of the operating mode active in the controller. Only when controller status is "KNX compliant".
D.Input controller extension KNX status	R.Output KNX status	For evaluation and display of special controller status messages (heating/cooling mode, controller disable, frost alarm, etc.). Only when controller status is "KNX compliant".
D.Input controller extension KNX status forced operating mode	R.Output KNX status forced operating mode	For evaluation and indication of the operating mode active in the controller in the case of forced position (higher priority than the "KNX status operating mode"). Only when controller status is "KNX compliant".
D.Input controller extension Controller status	R.Output Controller status	For evaluation and display of special controller status messages (operating mode, heating/cooling mode, controller disable, frost alarm, etc.). Only when Controller status "Controller general".
D.Input controller extension Status	R.Output Status signal addition	For evaluation and display of special controller status messages (comfort prolongation). Only when Controller status "Controller general".

signal addition		
D.Input controller extension	R.Output Heating message	For showing the information in the display of the controller extension that heating energy is demanded (symbol \ggg^+).
D.Input controller extension	R.Output Cooling message	For showing the information in the display of the controller extension that cooling energy is demanded (symbol \ggg^*).
D.Input controller extension Setpoint temperature	R.Output Setpoint temperature	Display of setpoint temperature in the display. Derivation of the displayed setpoint temperature in case of a setpoint shift in the configuration menu.

Table 10: Communication objects of the controller extension

- i** The controller extension requires status information from the controller in the formats "KNX compliant" or alternatively "Controller general". The 1-bit controller status "Transmit individual state" cannot be evaluated at the controller extensions!
- i** The actual room temperature can be detected by the communication objects of the room temperature measurement system, which are also available in the controller extension, and then shown in the display.

4.2.4.3.2 Operating functions

Operating mode switchover

Change-over of the controller operating mode can be effected in accordance with the standard function block for room temperature controllers defined in the KNX handbook with two 1-byte communication objects. The operating mode can be switched over with the normal and with the forced objects. The "B.Controller extension operating mode switchover" object offers a selection between the following operating modes...

- Comfort mode
- Standby mode
- Night mode
- Frost / heat protection

The "B.Controller extension forced-object operating mode" communication object has a higher priority. It permits forced switching between the following modes of operation...

- Auto (normal operating mode switchover)
- Comfort mode
- Standby mode
- Night mode
- Frost / heat protection

The operating mode transmitted to the bus on a button press of the controller extension is defined by the parameter "Operating mode on pressing the button". Depending on the configured functionality, it is possible that ...

- Either one of the above-mentioned modes is activated (single selection) on the press of the button,
- Or the device is switched over between various modes (multiple selection) each time a button is pressed.

i Notes on multiple selection:

In order to ensure that a switchover from one operating mode to another works properly even from different locations, the operating mode objects of the controller and those of all controller extension push button sensors must be interlinked and have their "Write" flag set. In the objects concerned, this flag is set by default

By checking the linked operating mode switchover object, the controller extension knows which of the possible operating modes is active. Based on this information, the device changes over into the next operating mode in sequence when a button is pressed. In the event that none of the possible operating modes is active, the next operating mode in the sequence is set to "Comfort" mode (in case of "Standby ->Night" to "Standby" mode). As far as switching over between the forced operating modes and "Auto" is concerned, the device switches into the "Auto" operating mode when none of the configured operating modes is active.

i It is not possible to program a reaction on release of the button. A long button-press is evaluated in the same way as short one and switches into the corresponding operating mode insofar as this is acceptable for the controller.

i If a status LED is to indicate the current operating mode, the status LED function must be programmed for "Operating mode indication" and its status object be linked with the corresponding group address for operating mode switchover with normal or high priority.

Presence button

All buttons with their function set to "Presence button" are internally linked with the "B.Controller extension presence button" object. The parameter "Presence function on pressing the button" defines the object value transmitted to the bus on pressing a button.

In order to ensure that the object value transmitted in the "Presence TOGGLE" setting is always the correct one, the presence object of the room temperature controller and the "Presence button" objects of the controller extension push button sensors must be interlinked and have their "Write" flag set. In the extension objects concerned, this flag is set by default.

It is not possible to program a reaction on release of the button. A long button-press is evaluated in the same way as short one and switches into the corresponding presence mode insofar as this is acceptable for the controller.

The status LED of the presence button can indicate both the presence status (setting "Button function indication active / inactive") and also the actuation of the button. In addition, the usual setting possibilities of the status LED are configurable as well .

Basic setpoint shift

The basic setpoint shift is another available function of the controller extension. It makes use of two 1-byte communication objects with data point type 6.010 (integer with sign). This extension function allows shifting of the basic setpoint for the temperature on a room temperature controller by pressing a button. Operation of the extension is generally the same as the operation of the main controller.

A button configured as a setpoint shift button reduces or increases the basic setpoint shift value on each press by one step width as specified by the main controller. The direction of the value adjustment is defined by the parameter "Setpoint shift on pressing the button". Releasing the button and a long press have no other functions.

- i** The operating function "Setpoint shift" is only available on a control extension if the main controller is working with relative setpoint presetting (basic setpoint). In the case of an absolute setpoint shift on the main controller, the setpoint shift on the controller extension has no effect. In this case controller extensions can forward setpoints to main controllers, for example by pressing a function button (Temperature value transmitter to the "Setpoint active operating mode" object).

Communication with main controller:

In order to enable the controller extension to effect a basic setpoint shift in a room temperature controller, the controller must have input and output objects for setpoint shifts. In this case, the output object of the controller must be linked with the input object of the extension unit and the input object of the controller must be linked with the output object of the extension via an independent group address (see page 167).

All objects are of the same data point type and have the same value range. A setpoint shift is interpreted by count values: a shift in positive direction is expressed by positive values whereas a shift in negative direction is represented by negative object values. An object value of "0" means that no setpoint shift has been activated.

Via the "B.Main controller current setpoint shift", the extensions are enabled to determine the current setpoint shift position. Starting from the value of the communication object, each button-press on an extension will adjust the setpoint in the corresponding direction by one count value level. Each time the setpoint is adjusted, the new shift is transmitted to the room temperature controller via the "B.Controller extension setpoint value specification" object of the controller extension. The controller itself checks the received value for the minimum and maximum temperature limits (see controller documentation) and adjusts the new setpoint shift if the values are valid. When the new count value is accepted as valid, the controller transfers this value to its output object for setpoint shifting and retransmits the value to the extension as positive feedback.





Due to the standard data point type used as the output and input object of the controller extension and the weighting of the individual level by the controller itself, each extension unit is able to determine whether a shift took place, in which direction it took place and by how many levels the setpoint was shifted. This requires that the communication objects are connected on all controller extensions and the controller.

The information for the step value as feedback from the controller enables the extension to continue the adjustment anytime at the right point. The extension units can likewise react to a reset of the setpoint shifting function by the controller.

- i For the controller extension to be able to evaluate and operate the basic setpoint shift correctly, the extension must also be configured and matched to the functions of the main controller. This function match is carried out using the "Upward adjustment of basic setpoint temperature" and "Downward adjustment of basic setpoint temperature" parameters in the "Room temperature control" parameter node. On the Version 1.2 application program, the parameter "Step width of the setpoint shift" must also be matched to the configuration of the main unit. These parameters must agree with the settings of the parameters of the same name in the main controller. Main controllers and controller extensions must always work with the same step width for the setpoint shift.

4.2.4.3.3 Display functions

Indication of the controller operating mode

The controller extension can indicate the current operating mode of the controller in the display. Just like on the controller itself the operating mode is indicated by the  (comfort),  (standby),  (night) and  (frost/heat protection) symbols. A comfort extension cannot be shown in the display if the controller status is configured to "KNX compliant". When the status is "Controller general", then it is possible to display a comfort extension.

This display information of the controller operating mode is obtained from the status communication objects of the controller extension. These objects should be connected to the main controller objects with the same function (see page 167)!

It is not possible to use the display information to distinguish whether the operating mode has been set via a forced object or via the 'normal' operating switchover. It is possible to change over the operating mode using the control function of the controller extension (see page 171).

Display of a basic setpoint shift

When 2-area display is configured, the controller extension can indicate a basic setpoint shift using the  icon. This icon lights up if the controller extension has received from the controller a basic setpoint shift in the positive or negative direction. In addition to displaying the icon, the push button sensor indicates the setpoint shift in the "Setpoint" menu even for controller extensions (see page 18-19). How it is shown there depends on the parameter setting in the ETS: either with a temperature value (absolute depiction) or using a bar graph (relative depiction). If the setpoint shift is depicted in the form of a bar graph, the shift is also visible in the normal display (see page 182).

In order for the display of a basic setpoint shift to function correctly, the communication objects "B.Main controller current setpoint shift", "B.Controller extension setpoint value specification" and "D.Input set temperature controller extension" must be connected with the objects with the same functions in the main controller (see page 167)! A basic setpoint shift can be set using the operating function of the controller extension (see page 172-173) or in the "Setpoint" menu.



-  The display function "Setpoint shift" is only available on a control extension if the main controller is working with relative setpoint presetting (basic setpoint). In the case of an absolute setpoint shift on the main controller, it is not possible to display a setpoint shift on the controller extension.

Indication of setpoint temperature

The controller extension can indicate the setpoint temperature of the room temperature controller in the display. If this display is desired, then the communication object "D.Input setpoint temperature controller extension" must be linked to the object of the main controller via which the setpoint temperature is transmitted to the bus. In addition, the display of the extension must be configured for the indication of the temperature setpoint (see page 182).

-  Regardless of the indication on the display, the current setpoint temperature of the main controller is decisive for the setpoint shift on the controller extension. For this reason the object "D.Input setpoint temperature controller extension" must be linked to the main controller!

Indication of the heating and cooling messages

The main controller can indicate on the display that heating and cooling energy is requested by the heating or cooling systems. This is indicated by the  symbol for heating or by the .

symbol for cooling.

For the indication to function, the signal objects for heating and cooling of the extension and main controller must be connected to each other (see page 167).

4.2.4.3.4 Room temperature measurement

Room temperature measurement by the device is always active, irrespective of the "Room temperature control" or "Controller extension" functions and can thus be used independently (e.g. for simple measurement and indication of a room temperature without feedback control). With a controller extension, the function of the room temperature measurement by the temperature sensor is as described in the chapter "Room temperature controller" (see page 152-153).

The controller extension can show the room temperature in the display. If this display is desired, the display of the extension must be configured to display the room temperature (see page 182).

4.2.4.3.5 Behaviour after a device restart

The different indication and operating functions of the controller extension are controlled via different communication objects as described in the previous chapters. A main controller must transmit the current status to the extensions, i.e. updating the communication objects so that, after a programming operation or after the return of bus voltage, all the status information is available for the initialisation of the extension. This takes place automatically for some objects during the initialisation of the main controller.

To ensure that all the objects are initialised correctly, some communication objects of the controller extension can also initialise automatically after a device restart as an option. For this, the parameter "Value request from controller extension?" the parameter node "Room temperature control" can be set to "Yes". The update takes place after a reset by means of a ValueRead telegram to the room temperature controller. This must answer the request with a ValueResponse telegram. If the extension does not receive all or some of the answers, the affected objects are initialised with "0". In this case, after a reset the objects must first be actively rewritten by the bus by other bus subscribers, e.g. through automatic transmission by the main controller. This is also always the case when the parameter "Value request from controller extension?" is configured to "No".

The automatic update takes place for all the transmitting objects with the name "B.Controller extension" and for the objects "D.Input controller extension".

- i The automatic update can take place with a delay after a device reset. If there are still other bus devices besides the push button sensor transmitting telegrams immediately after a reset, it may be useful to activate the transmit delay for in order to reduce the bus load (see page 79).
- i During commissioning, all extensions should be put into operation first. Only then should the main controller be connected and programmed. For larger KNX/EIB installations where the extensions are sometimes distributed over several lines, the remaining lines should also be initialized after a reset of one line.

4.2.4.4 Light scene function

Scene control

The push button sensor can be used in two different ways as part of a scene control system...

- Each rocker or button can work as a scene extension. This feature makes it possible to recall or to store scenes which may be stored in other devices (see page 93).
- The push button can independently store up to eight scenes with eight actuator groups. These internal scenes can be recalled or stored by the rockers or buttons (internal scene recall) and also by the communication object "B.Scene extension input".
In the following subsections the internal scene function will be dealt with in greater detail.

Scene definition and scene recall

If the internal scenes are to be used, the parameter "Scene function ?" in the parameter node "Scenes" must be set to "Yes".

The matching data types for the eight scene outputs must then be selected and adapted to the actuator groups used. The types "Switching", "Value (0 ... 255)" or "Value / blind position (0 ... 100 %)" can be selected. As a rule, Venetian blinds are controlled via two scene outputs. One output controls the blind height and the other one adjusts the slat position.

There is a separate parameter node available in the ETS for each scene output. The data types can be selected in this node using the parameters of the same name. The ETS sets the corresponding communication objects and the additional parameters of the scene commands.

The scene parameters can be set in the parameter node of a scene output for each individual scene ("scene 1 ... 8"). The setting options are the same for all 8 scenes.

It is possible that the values for the individual scenes preset by the parameters are modified later on with the storage function (see page 179-180) when the system is in operation. If the application program is then loaded again with the ETS, these locally adapted values will normally be overwritten by the parameters. Due to the fact that it may take considerable efforts to readjust the values for all scenes in the system, the parameter "Overwrite scene values during ETS download ?" offers the possibility of retaining the scene values stored in operation without overwriting them.

These internal scenes can be recalled directly via the rockers or buttons (function "Recall internal scene") and also by another bus device via the "B.Scene extension input" communication object. This 1 byte communication object supports the evaluation of up to 64 scene numbers. For this reason it must be specified which of the external scene numbers (1 ... 64) is to recall the internal scene (1 ... 8). This specification is made using the parameters "Recall scene 1...8 via extension object with scene number" in the "Scenes" parameter node. If the same scene number is listed for several internal scenes at this point, it is always only the first of these scenes that will be activated (scene with the lowest scene number).

In some situations there may be the requirement that a group of actuators is not controlled by all, but only by certain scenes. A classroom, for instance, may require open blinds for the "Welcome" and "Break" scenes, closed blinds in the "PC presentation" scene and no change in the "Discussion" scene. In this example, the parameter "Permit transmission ?" in the parameter node of a scene output can be set to "No" for the "Discussion" scene. The scene output is then deactivated during the corresponding scene.

The parameter "Transmit delay" permits an individual waiting time for each scene output. This transmit delay can be used in different situations...

- When the actuators participating in a scene transmit status messages automatically or when several scene buttons are used to increase the number of channels within the scenes, the recall of a scene may result for a short time in high bus loading. The transmit delay helps to reduce the bus load at the time of scene recall.
- Sometimes, it is desirable that an action is started only after another action has ended. This can be for instance the illumination which is to shut off only after the blinds/shutters have been raised.

The transmit delay can be set separately for each scene output in the parameter group of a scene. The transmit delay defines the time delay between the individual telegrams during a scene recall. The setting specifies how much time must pass after the first scene telegram before the second is transmitted. After transmission of the second scene telegram, the configured time must again pass before the third is transmitted and so forth... The transmit delay for the scene telegram of the first output starts immediately after the scene has been recalled. The transmit delay between telegrams can also be deactivated (setting "0"). The telegrams are then transmitted at the shortest possible time interval. In this case, however, the order of the telegrams transmitted can deviate from the numbering of the scene outputs.

- i** When a new scene recall (also with the same scene number) occurs during a current scene recall - even in consideration of the pertaining transmit delays - the scene processing started first will be aborted and the newly received scene number will be processed. A running scene is also aborted when a scene is being stored!
- i** During a scene recall - even if delayed - the operating areas of the push button sensor are operational.

Storing scenes

For each output of a scene, the user can define a corresponding scene value in the ETS which is then transmitted to the bus during a scene recall. During the ongoing operation of the system it may be necessary to adapt these preset values and to save the adapted values in the push button sensor. This can be ensured by the storage function of the scene control.

The value storage function for the corresponding scene number is enabled with the parameter "Permit storing ?" ("Yes") or disabled ("No"). When the storage function is disabled, the object value of the corresponding output is not sampled during storage.

A scene storage process can be initiated in two different ways...

- by a long press on a rocker or button of a control surface configured as "Scene extension",
- by a storage telegram to the extension object.

During a storage process, the push button sensor reads the current object values of the connected actuators. This is carried out by means of eight read telegrams (ValueRead) addressed to the devices in the scene which return their own value (ValueResponse) as a reaction to the request. The returned values are received by the push button sensor and taken over permanently into the scene memory. Per scene output, the push button sensor waits one second for a response. If no answer is received during this time, the value for this scene output remains unchanged and the push button sensor scans the next output.

In order to enable the push button sensor to read the object value of the actuator addressed when a scene is stored, the read flag of the corresponding actuator object must be set. This should be done only for one actuator out of an actuator group so that the value response is

unequivocal.

The stored values overwrite those programmed into the push button sensor with the ETS.

- i The storage process will always be executed completely by the push button sensor and cannot not be aborted before it has ended.
- i Recalling scenes in the course of a storage process is not possible, the buttons or rockers of the push button sensor remain nevertheless operational.

4.2.4.5 Display

4.2.4.5.1 Display structure and information displayed

Display structure

The device's graphics display has 103 x 40 pixels and is equipped with switchable LED backlighting. The display is subdivided into various display areas, depending on the configuration in the ETS, the operating state and the specific device functions that are activated. A general distinction can be made between 1-area and 2-area display. With two display areas (Figure 50), the upper area of the normal display (15), also called the status line, shows symbols that indicate various operating modes of the room temperature controller or the controller extension. Moreover it is optionally possible to display in the status line the time (left justified) and additional temperature values of the controller extension (right-justified).

The lower area of the display (16), also called the menu area, can be used to visualise various temperature values in a single-line or two-line format. In addition it is possible to display values that have been received by KNX/EIB via separate communication objects in various data and depiction formats. Furthermore, display of the time and date from an external KNX/EIB system clock in the graphics display can optionally be configured.

When only one display area is used (Figure 51), the normal display shows temperature values and indicates the operating mode of the room temperature controller. This type of display is the clearest and simplest display function, with only a single large menu area (17).

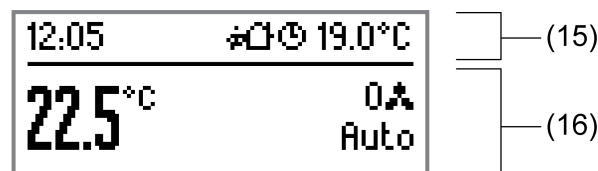

Figure 50: Example of a basic display with two display areas (Time, setpoint temperature, room temperature, fan level display)



Figure 51: Example of a basic display with one display area (Room temperature, operating mode display)

(15) Status line

(16) Menu area for 2-area display

(17) Large menu area for 1-area display

The form of the display areas and thus the selection of information shown on the display depends largely on the parameter configuration in the ETS (see "Display information" below). Moreover, the display can be used to show and change various settings of the device (see page 20).

Display functions

The display functions depend on the number of display areas.

2-area display:

In the 2-area display, a distinction is made between the display functions of the status line and those of the menu area. The status line can be configured with the following functions...

- Time
- Room temperature
- Outdoor temperature
- Setpoint temperature
- Time / room temperature
- Time / outdoor temperature
- Time / setpoint temperature

The time is always displayed left-justified within the status line. The temperature values available for selection are always displayed right-justified. In addition to the display functions that can be selected, the push button sensor shows in the central part of the status line information in the form of icons regarding the room temperature controller or the controller extension, the status of the push button sensor disable function, or the state of the heating timer (see page 188). If no temperature values are to be displayed in the status line (only indication of the time), then the icons are displayed right-justified in place of the temperature.

In the 2-area display the menu area can be configured with the following functions...

- Room temperature
- Outdoor temperature
- Setpoint temperature
- Room- / outdoor temperature *
- Room- / setpoint temperature *
- Outside / setpoint temperature *
- Value display *
- Setpoint shift as bar graph
- Only text display *

*: With selection of combined temperature values, value display or "only text display", the display appears in the menu area in a two-line format using a smaller character set.

Generally the selected temperature values are displayed left-justified in the menu area. The temperature value can be indicated in °C or alternatively in °F. The "Display format of the temperature values" is specified in the parameter of the same name in the ETS parameter node "Display". This parameter only affects the display. The temperature values in the communication objects are not affected by this. Here the value transfer always takes place in °C!

In the normal case, right-justified will be indicated in the menu area of the controller operating mode in the form of a large icon (18) (Figure 52), so long as the integrated controlled or the controller extension is activated. As an alternative to the operating mode icon, it is possible here to display the fan level and the fan operating mode (19) of a fan coil (Figure 53). To do this, the manual fan control has to be enabled (see page 195-196).

- i** The display of the large operating mode icon and the fan level is not possible in all display configurations. Such a display is not possible if "only text" should be displayed in the menu area, or the if the setpoint shift is displayed using a bar graph.



Figure 52: Example of a 2-area display with room temperature in the menu area and a large operating mode icon

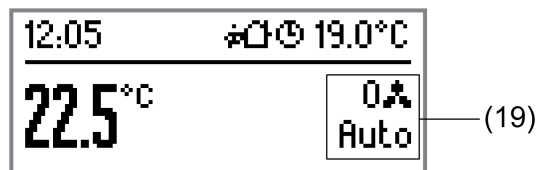

Figure 53: Example of a 2-area display with room temperature in the menu area and fan level display

(18) Large icon for operating mode display

(19) Display of fan level and fan operating mode

As an alternative to displaying temperature values with fixed formatting, the display of practically any desired 1-byte, 2-byte or 4-byte values that are forwarded to the push button sensor by the KNX/EIB via separate communication objects can be displayed in various data formats and representation formats. Thus, for example, it is possible to display dimming or brightness values of a lighting system (feedback from a dimmer actuator or a constant light regulation), to depict room temperatures from other building areas, to signal the height of blinds incl. slat angle (feedback from a shutter actuator), or also to display ASCII texts up to 14 characters long for other bus devices (e.g. facility management, alarm system).

Displaying of values in the menu area of the display is used if the display function is parameterised to "Value display". In this case the values are always displayed in two lines. It is thus possible to evaluate and depict up to two values independently of each other using separate communication objects.

The object type of the value display determines the display and formatting options within a line, and also the data format of the value object. The following object types are available...

- DPT 5.xxx, 6.xxx, 1-byte
Formatting: With or without sign Depiction of the values: 0...255, 0...100%, 0...360° (without sign) / -128...127 (with sign)
- DPT 7.xxx, 8.xxx, 9.xxx, 2-byte
Formatting: Integer or floating-point number. For floating-point number the number of positions after the decimal point is zero, one, two
- DPT 12.xxx, 13.xxx, 14.xxx, 4-byte
Formatting: Integer or floating-point number. For floating-point number the number of positions after the decimal point is zero, one, two
- DPT 16.xxx, 14 byte ASCII text
- DPT 10.001, 3-byte time
- DPT 11.001, 3-byte date
- Only text display

The values received from the bus are always displayed left-justified in the display (Figure 54). The controller operating mode is displayed right-justified in symbolic form, or otherwise the fan level is displayed in the same manner as the standard display functions for the temperature

values (see above). As an alternative to displaying the values, it is possible for a text to display only static texts, e.g. the declaration of a display value (Figure 55). In this case, the parameter "Object type of the value display..." must be parameterised to the setting "Only text display". The display text itself is then entered in the ETS as a "supplementary text" (see below). If the static text display is used in a line, the display no longer shows the controller operating mode right-justified in symbolic form, or alternatively no longer shows the fan level.

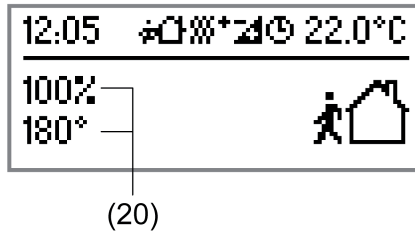

Figure 54: Example of a 2-area display with 2-line value display
Line 1 brightness value, line 2 slat angle

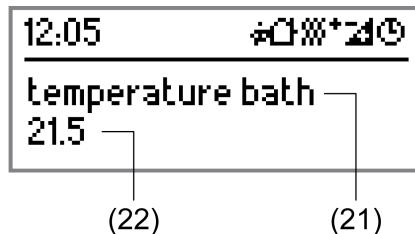

Figure 55: Example of a 2-area display with 2-line value display incl. text display
Line 1 "Only text display", line 2 temperature value

- (20) 2-line value display, line 1 and 2 value
- (21) 2-line value display, line 1 text only
- (22) 2-line value display, line 2 value

Display functions in one or two-line format can be expanded using supplementary texts (Figure 56). In this manner it is possible to describe the display values in greater detail, e.g. by adding a unit. The supplementary texts are always shown in the display to the immediate right of the display function (temperature value, value). Without a display function ("only text display") the supplementary text is shown left-justified in the display (Figure 57). The supplementary texts can be up to 30 characters. Each time a button is pressed, the ETS plug-in checks the pixel character spacing of the letter that has been entered, and if necessary limits the text being entered to the length that can be displayed.

- i** The operating mode display in symbolic form or the fan level display may overwrite the supplementary text entered in the ETS, if their length protrudes into the right-hand display area.
- i** In the display function "Setpoint shift as bar graph" (Figure 58) it is not possible to configure any supplementary texts.



Figure 56: Example of a 2-area display with 2-line value display incl. supplementary text. Line 1 brightness value, line 2 slat angle

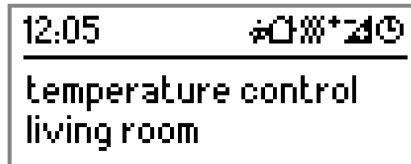



Figure 57: Example of a 2-area display with 2-line "only text display" display function

With relative setpoint presetting, the push button sensor allows step-by-step shifting of the setpoint temperature within defined limits. This setpoint shift can be performed either using the display buttons (see page 18-19) or using controller extensions in the positive (+) or also in the negative (-) direction. Whether a basic setpoint shift has been performed (i.e. the shift is not equal to "0") in the 2-area display is indicated using the  icon. Optionally it is possible to display the setpoint shift in the form of a bar graph (Figure 58). In this case the bar graph accounts for the entire menu area, which means that other display functions can no longer be displayed in this display area.

As soon as the "Setpoint shift as bar graph" is configured, instead of a temperature value the shift in the form of the bar graph is displayed in the "Setpoint shift" menu (operation of the display buttons).

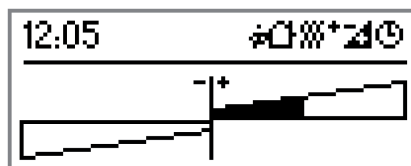

Figure 58: Example of a 2-area display with basic setpoint shifting as a bar graph

- i The display of the setpoint temperature or the display of the setpoint shift (as a bar graph) is only possible if either the room temperature controller or the controller extension is enabled! If the controller is configured in the ETS to absolute temperature setpoints, then it is no possible to perform any basic setpoint shift (see page 136)! In this case an empty bar graph is always shown in the display. It is then necessary to select a different display bar function. Unlike the basic setpoint shift with relative setpoint presetting, a setpoint shift with absolute setpoint presetting is not depicted with any particular icon in the display.

1-area display:

In the 1-area display there is only the large menu area (there is no status line). This type of display is the clearest and simplest display function. The menu area can be configured with the following functions...

- Room temperature
- Outdoor temperature
- Setpoint temperature

The selected temperature value is displayed left-justified in the menu area with a large character set (Figure 51). As with the 2-area display, depiction can be in °C or alternatively in °F. Right-justified will be indicated in the menu area of the controller operating mode in the form of a large icon, so long as the integrated controlled or the controller extension is activated.

- i** The display of the setpoint temperature or the display of the setpoint shift (as a bar graph) is only possible if either the room temperature controller or the controller extension is enabled!
- i** It is not possible to display the fan level if only one display area is configured.

Notes on the display functions

Indication of temperature values

The indication of the room temperature has a resolution of 0.1 °C and covers a range from -99.9 °C to +99.9 °C. The indication will refresh as soon as the determined room temperature changes within the resolution interval.

The indication of the outdoor temperature has a resolution of 0.1 °C and also covers a range from -99.9 °C to +99.9 °C. The temperature display will refresh as soon as a temperature value telegram is received via the "Outdoor temperature" object. After a device reset, the display shows "0,0 °C" until a telegram is received. If configured, the outdoor temperature will only be read on the display and cannot be used for any further temperature or variable calculation in the controller.

The temperature range of the setpoint temperature display depends on the configured operating mode and is given by the fixed values for the frost and/or heat protection temperature. The indication will refresh once a new setpoint temperature for the controller results (e. g. from a change of the operating mode or of the basic setpoint, etc.).

Indication of time information

The device possesses an internal clock, set using a communication object. The calculation of the current time is primarily influenced by the scope of the internally planned functions and the resulting data traffic. This may cause particularly large time deviations. For this reason, the internal clock should be synchronised on a regular basis. We recommend using, for example, an external KNX/EIB system clock to set the internal clock at least once an hour via the bus and thus keep the deviations as small as possible.

After a device reset, the display shows "--:--" until a time signal is received. The same indication for the time will appear unless the internal clock has been updated via the bus at least once a day (updating check at 4:00 a.m.).

The time is always in the 24-hour format. The day of the week is provided by the telegram of the time.

The internal clock of the push button sensor also controls the switching times of the heating timer. If the time should not be shown on the display, it is nevertheless necessary to describe the "Time" object properly and regularly using telegrams, so that the heating timer can work properly.

In the "Value display" display function the push button sensor may display a time that is received via a separate 3-byte communication object. This display time is independent of the internal clock of the push button sensor, and is only updated on the display if a new time telegram is received via the object of the display function. The same applies for displaying a date using the "Value display" function.

Special display information

In the un-programmed delivery state of the device, the text "**GIRA TS3plus**" is shown in the display. In addition, the room temperature determined by the internal sensor is displayed at the top right.

The display shows "**Prog**" during an ETS programming operation.

After a programming operation and for the duration of the device initialisation "**GIRA**" is shown in capital letters in the centre of the display, as well as the version number of the device firmware (e.g. "**Version: 1.00.00**").

If the push button sensor has been unloaded or programmed with invalid configuration data, then "**No Prog**" is displayed. The notes "**font Error**" or "**language error**" are displayed if a downloaded language is faulty. In this case it is necessary to repeat the programming operation of the language. If this error display appears repeatedly, then it is possible that the downloaded language file is faulty. We then recommend that you contact the manufacturer.

Display priorities

The individual display functions for the menu areas have various display priorities relative to each other. Display priorities with a higher priority overlap functions with a lower priority. The priority sequence of the display elements is shown in Table 11.

Display function	Priority
Alarm texts * (see page 190-191)	5 (high)
Fault message texts ** (see page 190)	4
Button help texts (see page 189)	3
Large symbols / fan level display	2
Temperatures / time / values / supplementary texts	1 (low)

Table 11: Priorities of the display functions+

*: Alarm texts can be overwritten with button help texts by means of a button-press. The alarm message is, however, shown again after the display length of the push button assistance function.

** : Fault message texts can be confirmed and thus hidden by pressing any button. No button help text is shown in this case.

4.2.4.5.2 Symbols

When 2-area display is configured, the push button sensor shows in the status line information in the form of small symbols regarding the room temperature controller or the controller extension, the status of the push button sensor disable function, or the state of the heating timer. The meanings of these symbols is explained in Table 12.













Display- ed symbols	Meaning
	"Comfort" operating mode active.
	"Standby" operating mode active.
	"Night" operating mode active.
	"Frost/heat protection" operating mode active.
	A "comfort extension" is active. **
	The controller is in dew point operation and is disabled. *
	Display of an active basic setpoint shift for relative setpoint presetting.
	Controller operation disabled. *
	Pushbutton sensor disabled.
	Heating mode active Heating energy is demanded (command value > 0).
	Cooling mode active. Cooling energy is demanded (command value > 0).
	The heating timer is active. *
	Display of the fan level and the fan heating/cooling mode " Auto " or " Manu ". This symbol is displayed right-justified only in the menu area, depending on the configuration.

Table 12: Meaning of the symbols in the status line of the 2-area depiction.

*: Not for controller extensions.

** : Not for controller extensions if the controller status is parameterised to "KNX compliant".

4.2.4.5.3 Push button assistance function

If desired, you can activate a push button assistance function for the function keys of the push button sensor in the ETS. The purpose of the pushbutton assistance function is to indicate to the operator what function will be executed when a key is actuated (e.g. "Dining light ON", "Blind DOWN", "Temperature comfort"). This help text display function can be activated centrally using the "Push button assistance" parameter in the "Display" parameter node.

The push button assistance is a one-line display text that can be parameterised in the ETS plug-in for each function rocker switch or pushbutton when the push button assistance function can be enabled (Figure 59). This text will be shown on the display of the pushbutton sensor immediately as soon as a rocker switch or button is pressed. At the same time the rocker switch or push button functions parameterised in the ETS will be executed, i.e. telegrams will be transmitted to the bus, for example, or the internal controller will be operated.

The display length (1...59 seconds) of the button help texts are determined by the parameters in the ETS with the same names.

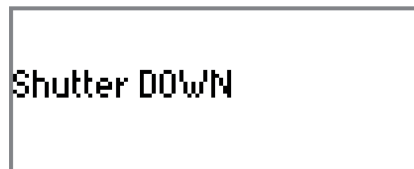

Figure 59: Example of push button assistance display text

Each button of a control surface (e.g. button 1 and button 2) can be assigned separately to a push button assistance text. With the rocker switch function of a control surface it is possible to specify a common push button assistance text for both rocker switch actuation points (left and right). An additional push button assistance text can be parameterised if full-surface operation is configured for the rocker switch in question.

The texts of each of the push button assistance functions can be up to 30 characters. Each time a button is pressed, the ETS plug-in checks the pixel character spacing of the letter that has been entered, and if necessary limits the text being entered to the length that can be displayed. If no text is input, the push button assistance for the button or rocker switch in question is inactive.

The button help texts are always shown left-justified in the middle line of the display, and overwrite all other display functions of the normal display for the configured display length. The display length is started again each time a button is pressed. A push button assistance text be overwritten with other button display texts (pressing another button).

- i** Please note that the button assistance function will be suppressed if the button lock function is active.
- i** Fault message texts (see page 190) can be confirmed and thus hidden ahead of time by pressing any button. No button help text is shown in this case. Alarm texts (see page 190-191) can be overwritten with button help texts by means of a button-press. The alarm message is, however, shown again after the display length of the push button assistance function.
- i** The functions of the two display keys are fixed so that any assistance for them will not be necessary and is thus not implemented.

4.2.4.5.4 Fault message and alarm texts

Fault message texts

It is possible to display up to two fault messages on the display of the push button sensor. What is possible to display is, for example, general information from the house management (facility management) or text messages from alarm centres. To activate the fault message display, set the "Fault message texts via bus" parameter in the "Display" parameter node to "activated". The two communication objects "Fault message text 1" and "Fault message text 2" are available for displaying the fault messages. If the push button sensor receives a telegram via one of these objects, the ASCII text contained in the telegram is shown on the display directly. Based on the data point type, the fault message texts can be up to 14 characters long.

- i Because the individual letters of the texts being shown have different lengths in the display character set, the push button sensor may abbreviate received texts to match the number of characters that can be depicted.

Fault messages are depicted on a special display page. If at least one fault message is present, the push button sensor displays the static text "**Fault message !**" at the upper edge of the screen.. The display area below that then shows the fault messages that have been received. The display is in two lines if both fault message objects have received a telegram (Figure 60). In this case, fault message text 1 is displayed at the top, and fault message text 2 at the bottom. If only one of the fault message objects has received a telegram, then the fault message text is displayed in one line in the centre (Figure 61).

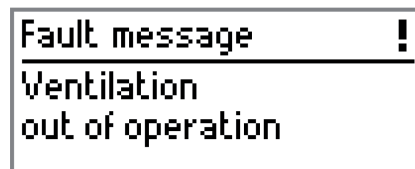

Figure 60: Example of a two-line fault message display

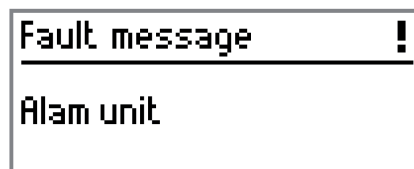

Figure 61: Example of a one-line fault message display

The fault message remains visible in the display until the display length configured in the ETS (1...255 minutes) has elapsed. Each telegram to one of the two fault message objects re-initiates the display length. Fault message texts visible on the display can be overwritten at any time with new text telegrams.

The display page of the fault message overwrites all other display functions of the normal display for the configured display length. Fault message texts can be confirmed and thus hidden ahead of time by pressing any button on the device. No button help text is shown in this case. The display text of a fault message can be overwritten by alarm texts. The fault message texts become visible again, however, after the alarm texts are acknowledged. In this case the push button sensor restarts the display length.

Alarm texts

It is possible to display up to two alarm messages on the display of the push button sensor. This can be used to implement, for example, the display of a burglar alarm or other message texts

with a higher priority. To activate the alarm message display, set the "Alarm texts via bus" parameter in the "Display" parameter node to "activated...". einzustellen.

The two communication objects "Alarm text 1" and "Alarm text 2" are available for displaying the alarm texts. If the push button sensor receives a telegram via one of these objects, the ASCII text contained in the telegram is shown on the display directly. Based on the data point type, the alarm texts can be up to 14 characters long.

- i** Because the individual letters of the texts to be displayed have different lengths in the display character set, the pushbutton sensor shortens received texts if necessary to the number of characters that can be depicted.

Alarm messages are depicted on a special display page. If at least one alarm message is present, the push button sensor displays the static text "**Alarm !**" at the upper edge of the screen.. The display area below that then shows the alarm texts that have been received. The display is in two lines if both alarm objects have received a telegram (Figure 62). In this case, alarm text 1 is displayed at the top, and alarm text 2 at the bottom. If only one of the alarm text objects has received a telegram, then the alarm text is displayed in one line in the centre (Figure 63).

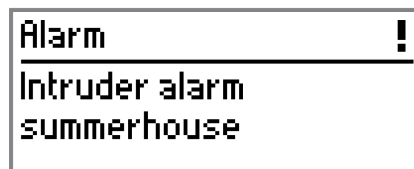

Figure 62: Example of a two-line alarm message display

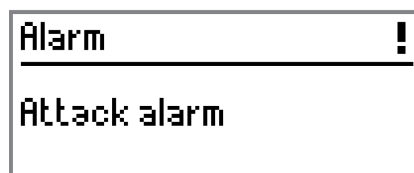

Figure 63: Example of a one-line alarm message display

Unlike the display of fault messages (see page 190), alarm messages remain in the display until the display is acknowledged actively. Acknowledgement in this manner is possible by pressing both display buttons of the device at the same time. An acknowledgement that has been made can optionally be transmitted to the bus via a separate 1-bit communication object and thus forwarded to other bus devices (e.g. visualisations). In this case the parameter "Alarm texts via bus = activated with acknowledgment object" must be configured. Then the "Alarm text acknowledge" transmits an acknowledgement telegram to the bus immediately after a successful acknowledgment. The telegram polarity can be configured in the ETS. If the parameter "Alarm texts via bus" is configured to "activated without acknowledgement object", then no bus acknowledgement is performed. The alarm is merely confirmed locally on the device.

Alarm texts visible on the display can be overwritten at any time with new text telegrams to the alarm objects. The display page of the alarm message overwrites all other display functions of the normal display. Alarm texts can be overwritten with button help texts by means of a button-press. The alarm message is, however, shown again after the display length of the push button assistance function.

4.2.4.5.5 Manual fan control and fan level display

Introduction

The manual fan control makes it possible to control the fan of a fan coil, independent of the command value specification of a room temperature controller. This enables requirements-oriented ventilation of a room in any desired, manually specified fan level. With the push button sensor 3 plus, manual control of the fan is possible via a rocker switch or push button function and also via the configuration menu.

Independently of the fan control, the current fan level of a fan coil and its heating/cooling mode can be shown on the display of the push button sensor.

- i** The manual fan control of the push button sensor 3 plus is adapted to the functions of the Gira KNX/EIB fan coil actuator (order no. 2163 00). Other fan coil actuators cannot be actuated or evaluated, or only to a limited extent.

The manual fan control and the fan level display are configured centrally in the ETS parameter node "Display". The function must be enabled globally here so that manual fan control is possible via the device rockers or buttons and via the configuration menu. The fan levels can also only be shown in the display of the push button sensor after global enable has been made.

Configuration and adjustment of the fan coil actuator

So that the push button sensor 3 plus can control the Gira KNX/EIB fan coil actuator, it is necessary to link various communication objects of the push button sensor with objects of the actuator. Furthermore, various parameters of the actuator have to be set to manual fan control via the push button sensor in the actuator's ETS application program.

Parameter configuration:

In automatic mode of the fan coil actuator the fan levels are controlled directly using command value objects of a room temperature controller. This room temperature controller may be a push button sensor 3 plus. In operation of the fan coil convector it is possible for the automatic mode to be overridden by a manual fan control. Then the actuator no longer reacts to the controller command value for control of the blower fan, but rather only to the manual fan level presetting, e.g. from the push button sensor 3 plus.

In order to prepare the actuator for manual fan control via the push button sensor, the fan coil actuator has to be configured as follows...

- The parameter "Manual fan control" on the parameter page "Manual fan control" must be set to "enabled".
- The parameter "Activation of manual fan control" must be set to "Via object 'Man. fan cont. active/inactive'".
- The parameter "Fan level switchover in case of manual specification via" defines in the actuator whether the fan levels are switched over manually using a 1-bit object (switching direction presetting) or alternatively using a 1-byte object (value presetting). The push button sensor 3 plus supports both methods for manual control. The data format of the fan level presetting is determined in the push button sensor via the parameter with the same name compared to the actuator; this parameter is on the "Display" parameter page. The push button sensor and actuator must be configured to the same data format!

- i** When the fan levels are switched over using 1-byte value telegrams, the push button sensor evaluates the feedback from the actuator. With fan level presetting using 1-byte value telegrams, we recommend setting the dwell time / pause "OFF" for level switchover in the fan coil actuator to values larger than 1 second. This is important especially in the case of manual fan control using buttons or via the configuration menu, because the fan level last reported back by the actuator is used as the initial value for changing when a button is pressed. With fan level switchover times of less than 1 second it is difficult for the operator of the push button sensor to determine which fan level is the current one at the moment that the button is pressed, because actuator switches the fan level downwards step by step when the manual control is activated, as long as no presetting has been made by the push button sensor.
- With fan level presetting using 1-bit telegrams the dwell time / pause "OFF" for level switchover in the fan coil actuator can also be set to smaller values, because with manual control the last fan level always remains set and the actuator does not switch the levels downwards before the first presetting.
- It is generally recommended to execute the switchover of the fan levels using the 1-bit object (switching direction presetting).
- The parameter "Manual fan control only with active heating / cooling" in the actuator defines whether with manual control the fan is only allowed to run if the heating or cooling valve in the fan coil is also open. Even with manual fan control, the valves are always actuated via the command value telegrams of the controller.
The setting "Yes" or "No" for this parameter depends on the functions of the fan control of the push button sensor, and can be adapted as requested by the customer or the heating/cooling system. If the parameter is set to "Yes", it is only necessary to note that manual control is only possible if heating or cooling energy is actually being demanded at that time by the controller command values.
 - It is possible to set in the fan coil actuator whether manual fan control should be activated automatically after a device reset. This defines the actuator parameter "Activate manual fan control after bus or mains voltage return?". If this parameter is set to "Yes", the fan coil actuator activates manual fan control immediately after the reset and also transmits this state to the push button sensor via a feedback object. The latter can then show the correct operating state of the actuator on the display.
 - To show the current fan level in the display, and also for manual fan control (using a 1-byte value), the push button sensor requires the information as to which fan level is active in the actuator. In addition, the fan coil actuator must transmit a fan level feedback telegram to the push button sensor. To do this, it is necessary in the application program of the actuator to set the parameter "Feedback for the active fan level" on the parameter page "Fan feedback" to "Yes, active signal object".
Subsequently it is possible to define in the actuator what the data format of the fan level feedback should be. The data format is determined using the "Type of feedback" parameter. With the "Fan levels individually" setting, separate objects are defined separately for each fan level. When the fan level is changed, the actuator updates and transmits only the object values that change. With the setting "Fan levels via value", only one communication object is visible in common for all fan levels. When the fan level is changed, the actuator always updates and transmits the current object value.
The receiving object of the fan level feedback in the push button sensor must be set to the same data format as the actuator! Configuration of the data format for the push button sensor is performed using the parameter "Fan level display object type" parameter on the parameter page "Display".
- i** It is generally recommended to configure the fan level feedback via value.
- After a reset of the KNX/EIB system (e.g. bus voltage failure) the push button sensor initialises itself and the fan coil actuator simultaneously. Due to the controller initialisation it may occur that the push button sensor requires a longer time to become ready for operation. In order for all of the feedback telegrams of the fan coil actuator to reach the push button sensor while it is ready for operation, it is necessary to set a "Delay after bus voltage return" of at least 10 seconds in the actuator. This delay affects all feedback telegrams of the fan coil actuator, and can be configured generally on the "Times" parameter page.

- i** After the push button sensor has been programmed using the ETS, all of its objects of the fan control are initially "0" (fan OFF, control inactive). So that the correct state of the fan coil can be displayed and evaluated, in such a case, the actuator must transmit its feedback telegrams to the push button sensor. This can, for example, be forced using a bus reset of the line in which the fan coil actuator is located. It should be noted that other devices in the line in question also perform a reset and reinitialise themselves.

Object configuration:

When the fan level display and fan control are enabled in the push button sensor, four communication objects with various data formats are visible in the ETS. For the purpose of identification these objects have the name "B.Manual fan control". They must be linked with the objects of the fan coil actuator with the same functions, each using a separate group address (Figure 64)!

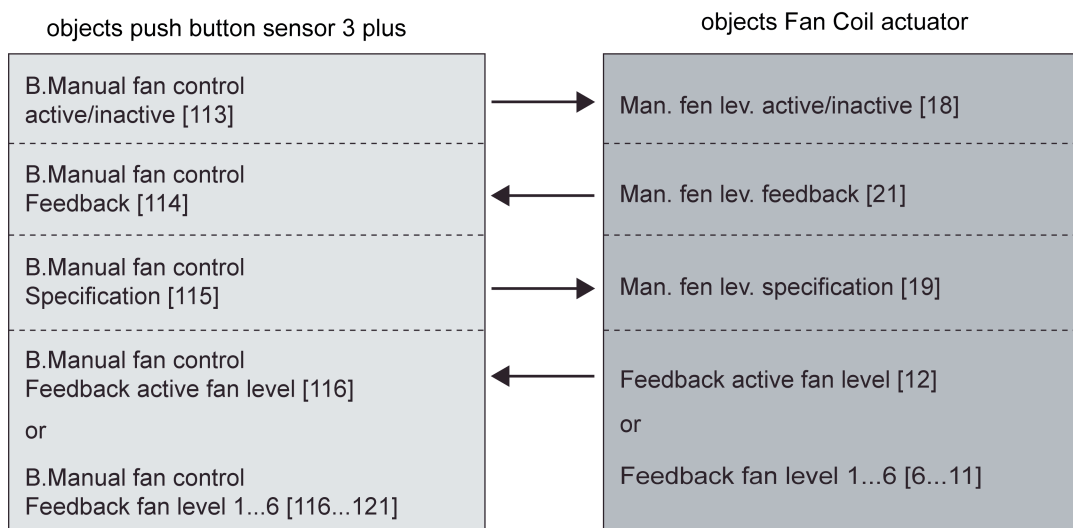

Figure 64: Communication objects of the manual fan control (1-to-1 linking with objects of the fan coil actuator with the same functions)

Meaning of the objects with the push button sensor...

- "B.Manual fan control active/inactive":

The push button sensor uses this 1-bit object to inform the fan coil actuator that manual fan control should be executed. When a "1" telegram is received, the actuator switches directly from automatic mode to manual operation. The push button sensor automatically controls the corresponding telegram values when the manual fan control is operated (note feedback! See next object.).

- "B.Manual fan control feedback":

The switching value of this object allows the push button sensor to detect which operating mode is activated on the actuator. The push button sensor uses this feedback to derive whether automatic mode or manual operation should be shown on the display. Furthermore, the push button sensor requires this information in order to evaluate the state of the operating mode correctly and switch it over if necessary when a rocker switch or pushbutton is operated. Manual fan control has no effect as long as the push button sensor has not received any feedback from the actuator.

- "B.Manual fan control specification":

The push button sensor uses this object to inform the fan coil actuator about the manually set

fan level. The data format of this object has a size of either 1 bit or alternatively 1 byte, depending on the parameter "Fan level switchover in case of manual specification via". The object must have the same data format as the object of the actuator with the same function!

- "B.Manual fan control feedback active fan level":

To display the active fan level, the push button sensor requires feedback from the fan coil actuator as to which of the fan levels is currently set. Furthermore, the feedback is important for the fan level presetting by the push button sensor, if this is performed via a 1-byte value object. Depending on the parameter "Fan level display object type", the push button sensor evaluates the data format of the feedback as 1 x 1 byte or as 6 x 1 bit. With the 1-bit feedback, each of the up to 6 fan levels has its own object. The object types used must be the same as those of the object types of the actuator with the same functions!

i The activation of the fan levels can be configured in the fan coil actuator. Activation is possible using either the switchover principle (only one fan level output is switched), or level principle (fan levels switch hierarchically). In the case of a fan level feedback telegram in the format "6 x 1 bit" and with the fan level switchover principle configured, "0" is shown briefly on the display of the push button sensor as the active fan level at the moment of switchover. This is done because in the switchover pause the actuator reports "0" and only after that sets the desired fan level. Therefore when operating the manual fan control on the push button sensor with the fan level switchover principle a waiting time must be inserted between the individual button-presses. The length of the waiting time should be at least equal to the configured "OFF" pause of the fan coil actuator. Otherwise manual operation may be inadvertently deactivated. This effect is not present with fan level feedback in the format "1 x 1 byte". It is generally recommended to configure the fan level feedback via value.

i With regard to manual fan control, a fan coil actuator can also be controlled from various control sections (e.g. using multiple push button sensor 3 plus units). It should be noted that objects with the same function of all control sections have to be connected with the actuator using the same group addresses.

i For a more detailed description of the individual parameter configuration and the functions of the manual fan control, including expanded functions of the fan coil actuator with higher priorities (e.g. switch-on level), please refer to the product documentation for the actuator.

Fan level display

The active fan level of a fan coil and its fan level operating mode (automatic mode or manual operation) can be shown on the display of the push button sensor. In automatic mode of the fan coil the fan levels are controlled directly using command value objects of a room temperature controller. This room temperature controller may be a push button sensor 3 plus. In operation of the fan coil convector it is possible for the automatic mode to be overridden by a manual fan control. Then the actuator no longer reacts to the controller command value for control of the blower fan, but rather only to the manual fan level presetting, e.g. from the push button sensor 3 plus.

Indication on the display takes place if the manual fan control and the fan level display are enabled globally on the "Display" parameter page. In this case the fan level reported by the actuator of the blower fan and the fan operating mode "Automatic operation" (Figure 65) or "Manual operation" (Figure 66) are displayed in plain text.



Figure 65: Example for a fan level display in automatic operation

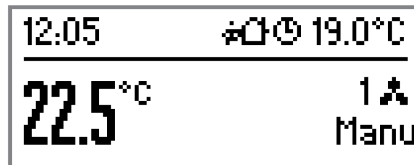

Figure 66: Example for a fan level display in manual operation

It is not possible to display the fan level in all display configurations. Fan level display is not possible if only one display area is configured, if only text should be displayed in the menu area, or if the setpoint shift is displayed using a bar graph. In all other display configurations the fan level display appears right-justified in the menu area, as shown in the illustrations. It thus overwrites the symbolic depiction of the controller operating mode in this display area, and possibly the supplementary texts entered in the ETS.

- i** To allow the push button sensor to display the current fan level and the fan heating/cooling mode properly, various communication objects have to be linked with the actuator of the fan coil. Furthermore, various parameters of the actuator have to be set to manual fan control via the push button sensor in the actuator's ETS application program (see page 192).
- i** In case of a fan level feedback telegram from the fan coil actuator to the push button sensor in the data format 1 x 1 byte, the display shows "-" for the active fan level if the reported fan level value is greater than "6".

4.2.4.5.6 Display illumination

The display of the device has white backlighting. The function of the backlighting is specified in the "Function of the LCD illumination" parameter in the "Display" parameter node in the ETS.

- For orientation, the LCD illumination can be switched permanently on or off.
- The LCD illumination can be switched using a separate 1-bit communication object (the telegram polarity can be configured). It is also possible here to control flashing with a frequency of approx. 2 Hz via the object.
- The background illumination can be switched on by pressing any desired button and switched off again automatically after a delay time has elapsed. Here the parameter "Time for automatic switch-off" in the parameter node "Display" defines the length of the delay until switch-off after the last button-press. Each button-press re-initiates the delay time.
- The backlighting can flash together with all status LEDs with a frequency of about 2 Hz, when the communication object for the alarm message display is active.

i The display of an alarm has a higher priority than the parameterisation of the LCD illumination in the ETS.

i The brightness of the LCD illumination and all status-LEDs can be defined in the ETS on the "General" parameter page. Optionally the brightness can be changed during operation of the push button sensor, controlled by a 1-bit communication object.

4.2.4.6 Delivery state

As long as the push button sensor has not yet been programmed with application data by means of the ETS, the labelling field illumination and the backlighting of the display flash at a slow rate (approx. 0.75 Hz). When any of the buttons or rockers is pressed, the appropriate status LED lights up briefly for the duration of the button actuation (button-press display). Each time a button is pressed the colour of the status LED changes starting with red, then to green and blue. This condition persists until the application is programmed into the device. No telegram is transmitted to the bus in the event of a button-press.

The text "**GIRA TS3plus**" is shown on the display. In addition, the room temperature determined by the internal sensor is displayed at the top right.

4.2.5 Parameters

4.2.5.1 General parameters

Description	Values	Comment
<p>□ General</p> <p>Transmit delay after reset or bus voltage return</p>	<p>Yes No</p>	<p>After the application program or the physical address is loaded or after the bus voltage is switched on, the push button sensor for the room temperature controller extension unit can transmit telegrams automatically. The push button sensor then requests from the room temperature controller the current state for all the transmitting objects with the name "B.Controller extension" and for the objects "D.Input controller extension". After a device reset, the telegrams for room temperature measurements (external sensor) are also automatically transmitted to the bus.</p> <p>If there are still other bus devices besides the push button sensor transmitting telegrams immediately after a reset, it may be useful to activate the transmit delay for automatically transmitting objects in order to reduce the bus load.</p> <p>When transmit delay is activated (setting: "Yes"), the push button sensor computes the time delay from its device ID in the physical address. The sensor then waits 30 seconds maximum before transmitting telegrams.</p>
<p>Colour selection of all status LEDs</p>	<p>red</p> <p>green</p> <p>blue</p> <p>Colour selection per rocker switch/button</p>	<p>The colour of the status LED can be selected here. In the colour configuration a distinction is made between whether all of the status LEDs of the push button sensor have the same colour (setting "red", "green" or "blue"), or whether alternatively various colours can be configured for the LEDs ("Colour selection per rocker switch/button" setting). With colour selection per rocker switch or button it is possible to set the colour on the parameter pages of the individual status LEDs.</p>
<p>Light period of status LED for button-press indicator</p>	<p>1 sec 2 sec 3 sec</p>	<p>This parameter defines the switch-on time the status LED is lit up to indicate actuation. The setting concerns all status LEDs whose function is set to</p>

	4 sec 5 sec	"Button-press display".
Function of the labelling field illumination	always OFF always ON control via object automatic switch-off	This parameter defines the function of the labelling field illumination. The labelling field illumination can be permanently on or off or alternatively be switched via a communication object. Optionally the labelling field illumination can be switched on by pressing any desired button and switched off again automatically after a delay time has elapsed. Here the parameter "Time for automatic switch-off" defines the delay until switch-off after the last button-press. Each button-press re-initiates the delay time.
Activation via object value	1 = static ON / 0 = static OFF 0 = static OFF / 0 = static ON 1 = flashing / 0 = static OFF 0 = static OFF / 0 = LED flashing	If the "Function of the labelling field illumination" is set to "Control via object", then the telegram polarity of the 1-bit object "B.Labelling field illumination" can be specified at this point. The illumination can be switched on or off statically. In addition, the received switching telegram can be evaluated in such a way that the illumination flashes.
Time for automatic switch-off Minutes (0...20)	0...20	If the "Function of the labelling field illumination" is set to "Automatic switch-off", the delay before switch-off after the last button-press can be configured here. Setting the delay time minutes.
Seconds (0...59)	0... 3 ...59	Setting the delay time seconds.
Brightness for all LEDs	Level 0 (OFF) Level 1 (dark) Level 2 Level 3 Level 4 Level 5 (bright)	The brightness of all status LEDs, the labelling field illumination and the LCD backlighting of the push button sensor can be defined. The regular illumination brightness of all LEDs can be set here in 6 levels.
Night reduction for reduced LED brightness?	Yes No	Optionally the brightness can be changed during operation of the push button sensor, controlled by a 1-bit communication object. Changing may be advisable, for example, to reduce the brightness during nighttime hours. If switchover of the brightness via the object is required, then it is necessary to set this parameter to "Yes". In this case

the communication object "B.LED night reduction" becomes visible in the ETS. As soon as a "1" telegram is received via this object, the push button sensor redirects to the "Brightness for all LEDs during night reduction" configured in the ETS. If a "0" telegram is received via the object, the push button sensor redirects back to the regular brightness.

Brightness for all LEDs
in night reduction

Level 0 (OFF)
Level 1 (dark)
Level 2
Level 3
Level 4
Level 5 (bright)

Setting the reduced LED brightness.
Only visible for "Night reduction for
reduced LED brightness?" = "YES".

4.2.5.2 Parameters on the push button sensor function section

Description	Values	Comment
<p>☐☒ Push button sensor</p> <p>Operation concept of buttons 1 and 2</p> <p>(The same parameters are available for the other operating areas / button pairs.)</p>	<p>Rocker function (rocker 1)</p> <p>push button function</p>	<p>For each operating area, the user can specify independently whether it is to be used as a rocker with a common basic function or as two different buttons with completely independent functions. Depending on this setting, the ETS displays different communication objects and parameter pages.</p>
<p>Button evaluation</p> <p>(The same parameters are available for the other operating areas / button pairs.)</p>	<p>Single-area operation (only as button 1)</p> <p>Double-area operation (as buttons 1 + 2)</p>	<p>If the operation concept of an operating area is configured as "push button function", this parameter can be used to specify whether single-surface or double-area operation should be implemented.</p> <p>In "Single-area operation (only as button 1)", the entire control surface is evaluated only as a single "large" button. The surface can be depressed at any desired point in order to execute the underlying push button function. In this setting, the button with the even button number of the button pair (e.g. button 2) is inactive and physically not present. In "Double-area operation (as buttons 1 + 2)" the control surface is divided into two mutually independent buttons.</p>
<p>☐☒ Push button sensor -> Rocker 1 (Buttons 1/2) (Only if "Function of buttons 1 and 2 = as one rocker (rocker 1)!")</p> <p>Text for push button assistance function</p>	<p>Rocker switch 1 push button assistance function, free text with up to 30 characters</p>	<p>The push button assistance text is parameterised here. The maximum length of the push button assistance text is 30 characters. Each time a button is pressed, the ETS plug-in checks the pixel character spacing of the letter that has been entered, and if necessary limits the text being entered to the length that can be displayed. If no text is input, the push button assistance for the button or rocker switch in question is inactive. This parameter is only visible if the "Push button assistance function" parameter on the "Display" parameter page is set to "Activated".</p>
<p>Text for push button assistance for full-surface operation</p>	<p>Push button assistance W1 full, free text with up to 30 characters</p>	<p>The push button assistance text for full-surface operation is parameterised here. The maximum length of the push button assistance texts is 30 characters. Each time a button is pressed, the ETS plug-in checks the pixel character spacing of the letter that has been entered, and if</p>

Function	<p>Switching Dimming Venetian blind 1-byte value transmitter 2-byte value transmitter Scene extension 2-channel operation Manual fan control</p>	<p>necessary limits the text being entered to the length that can be displayed. If no text is input, the push button assistance for the button or rocker switch in question is inactive. This parameter is only visible if the "Push button assistance function" parameter on the "Display" parameter page is set to "Activated" and full-surface operation is enabled!</p> <p>This parameter is used to define the basic function of the rocker. Depending on this choice, the ETS displays different communication objects and parameters for this rocker.</p>
----------	--	--

The following parameters are only valid for the rocker function "Switching"...

Command on pressing left rocker	<p>No reaction ON OFF TOGGLE</p>	<p>These parameters specify the reaction when the left rocker is pressed or released.</p>
---------------------------------	--	---

Command on releasing left rocker	<p>No reaction ON OFF TOGGLE</p>
----------------------------------	--

Command on pressing right rocker	<p>No reaction ON OFF TOGGLE</p>	<p>These parameters specify the reaction when the right rocker is pressed or released.</p>
----------------------------------	--	--

Command on releasing right rocker	<p>No reaction ON OFF TOGGLE</p>
-----------------------------------	--

The following parameters are only valid for the rocker function "Dimming"...

Command on pressing left rocker	<p>No reaction Brighter (ON) Darker (OFF) Brighter / darker (TOGGLE) Brighter (TOGGLE) Darker (TOGGLE)</p>	<p>This parameter defines the reaction when the left rocker is pressed. If the push button sensor is to toggle on a brief press, the corresponding switching objects of other sensors with the same function must be linked with one another.</p>
---------------------------------	--	---

Command on pressing right rocker	<p>No reaction Brighter (ON) Darker (OFF) Brighter / darker (TOGGLE) Brighter (TOGGLE) Darker (TOGGLE)</p>	<p>This parameter defines the reaction when the right rocker is pressed. If the push button sensor is to toggle on a brief press, the corresponding switching objects of other sensors with the same function must be linked with one another.</p>
Time between switching and dimming, left rocker (100 ... 50000 x 1 ms)	100 ... 400 ... 50000	<p>This parameter defines how long the left rocker must be pressed for the push button sensor to send a dimming telegram.</p>
Time between switching and dimming, right rocker (100 ... 50000 x 1 ms)	100 ... 400 ... 50000	<p>This parameter defines how long the right rocker must be pressed for the push button sensor to send a dimming telegram.</p>
Advanced parameters	<p>Activated Deactivated</p>	<p>When the advanced parameters are activated, the ETS shows the following parameters.</p>
Advanced parameters activated...		
Increase brightness by	<p>1.5 % 3 % 6 % 12.5 % 25 % 50 % 100 %</p>	<p>This parameter sets the relative dimming level when the brightness is increased. On each button-press, the brightness is changed at maximum by the configured level. Especially with smaller dimming levels it is advisable for the push button sensor to repeat the dimming telegrams automatically (see "telegram repetition").</p>
Reduce brightness by	<p>1.5 % 3 % 6 % 12.5 % 25 % 50 % 100 %</p>	<p>This parameter sets the relative dimming level when the brightness is reduced. On each button-press, the brightness is changed at maximum by the configured level. Especially with smaller dimming levels it is advisable for the push button sensor to repeat the dimming telegrams automatically (see "telegram repetition").</p>
Transmit stop telegram?	<p>yes No</p>	<p>On "Yes" the push button sensor transmits a telegram for stopping the dimming process when the rocker is released. When the push button sensor</p>

		transmits telegrams for dimming in smaller levels, the stop telegram is generally not needed.
Telegram repeat?	Yes No	This parameter can be used to activate telegram repetition for dimming. With the button held down, the push button sensor will then transmit the relative dimming telegrams (in the programmed level width) until the button is released.
Time between two telegrams	200 ms 300 ms 400 ms 500 ms 750 ms 1 sec 2 sec	This parameter defines the interval at which the dimming telegrams are automatically repeated in the telegram repetition mode. This parameter is visible only if "Telegram repetition = Yes"!
Full-surface operation	enabled disabled	When the full-surface operation is enabled, the ETS shows the following parameters.
Function for full-surface operation	Switching Scene recall without storage function Scene recall with storage function	In case of full-surface operation, this parameter defines the function that is to be used. The ETS shows the corresponding communication object and the other parameters. If the push button sensor is to recall a scene with storage function by full-surface actuation, it will make a distinction between a brief press (less than 1 s), a sustained press (longer than 5 s) and an invalid button-press (between 1 s and 5 s). A brief press recalls the scene, a sustained press stores a scene and an invalid full-surface operation is ignored. This parameter is visible only if "Full-surface actuation = enabled"!
Command for full-surface operation	ON OFF TOGGLE	This parameter defines the value of the transmitted telegram when a full-surface operation has been sensed. "TOGGLE" changes over the current object value. This parameter is visible only if "Full-surface actuation = enabled"!
Scene number (1 ... 64)	1, 2, ..., 64	This parameter defines the scene number which is to be transmitted to the bus after a scene recall or during storage of a scene.

This parameter is visible only if "Full-surface actuation = enabled"!

The following parameters are only valid for the rocker function "Venetian blind"...

Command on pressing rocker	<p>Left rocker: UP / Right rocker: DOWN</p> <p>Left rocker: DOWN / Right rocker: UP</p> <p>Left rocker: TOGGLE / Right rocker: TOGGLE</p>	<p>This parameter defines the running direction of a drive after a button-press. If the setting is "TOGGLE", the direction is changed after each long time command. If several push buttons are to control the same drive, the long time objects of the push buttons must be interlinked for a correct change of the running direction.</p>
Operation concept	<p>short – long – short</p> <p>long – short</p> <p>short – long</p> <p>long – short or short</p>	<p>For Venetian blind control, four different operation concepts can be selected. For these concepts, the ETS shows further parameters.</p>
Time between short time and long time command, left rocker (1 ... 3000 x 100 ms)	1 ... 4 ... 3000	<p>This parameter sets the time after which the long time operation will be evaluated on pressing the top (or left-hand) button of the rocker.</p> <p>This parameter is not visible with "Operation concept = long – short"!</p>
Time between short time and long time command, right rocker (1 ... 3000 x 100 ms)	1 ... 4 ... 3000	<p>This parameter sets the time after which the long time operation will be evaluated on pressing the bottom (or right-hand) button of the rocker.</p> <p>This parameter is not visible with "Operation concept = long – short"!</p>
Slat adjusting time, left rocker (0 ... 3000 x 100 ms)	0 ... 5 ... 3000	<p>Time during which a transmitted long time telegram can be terminated by releasing the left button of the rocker (short time). This function serves to adjust the slats of a blind.</p> <p>This parameter is not visible with "Operation concept = long – short"!</p>
Slat adjusting time, right rocker (0 ... 3000 x 100 ms)	0 ... 5 ... 3000	<p>Time during which a transmitted long time telegram can be terminated by releasing the right button of the rocker (short time). This function serves to adjust the slats of a blind.</p> <p>This parameter is not visible with</p>

"Operation concept = long – short"!

Full-surface operation	enabled disabled	When the full-surface operation is enabled, the ETS shows the following parameters. Full-surface operation can only be programmed if "Operation concept = long – short or short"!
Function for full-surface operation	Switching Scene recall without storage function Scene recall with storage function	In case of full-surface operation, this parameter defines the function that is to be used. The ETS shows the corresponding communication object and the other parameters. If the push button sensor is to recall a scene with storage function by full-surface actuation, it will make a distinction between a brief press (less than 1 s), a sustained press (longer than 5 s) and an invalid button-press (between 1 s and 5 s). A brief press recalls the scene, a sustained press stores a scene and an invalid full-surface operation is ignored. This parameter is visible only if "Full-surface actuation = enabled"!
Command for full-surface operation	ON OFF TOGGLE	This parameter defines the value of the transmitted telegram when a full-surface operation has been sensed. "TOGGLE" changes over the current object value. This parameter is visible only if "Full-surface actuation = enabled"!
Scene number (1 ... 64)	1, 2, ..., 64	This parameter defines the scene number which is to be transmitted to the bus after a scene recall or during storage of a scene. This parameter is visible only if "Full-surface actuation = enabled"!

The following parameters are only valid for the rocker function "Value transmitter 1-byte"...

Function	Left rocker / right, no function Left rocker: 0 ... 255 / Right rocker: 0 ... 255 Left rocker: 0 ... 100 % / Right rocker: 0 ... 100 % Left rocker: 0 ... 255 /	A rocker configured as "Value transmitter 1 byte" permits selecting whether the values to be transmitted are interpreted as integers from 0 to 255 or as a percentage from 0 % to 100 %. The following parameters and their settings depend on this distinction.
----------	---	--

	Right rocker: No function	
	Left rocker: 0 ... 100 % / Right rocker: No function	
	Left rocker: No function / right rocker: 0 ... 255	
	Left rocker: No function / right rocker: 0 ... 100 %	
Value, left rocker (0 ... 255)	0...255	This parameter defines the object value when the left rocker is pressed. Visible only if "Function = 0...255"!
Value, right rocker (0 ... 255)	0...255	This parameter defines the object value when the right rocker is pressed. Visible only if "Function = 0...255"!
Value, left rocker (0 ... 100 %)	0...100	This parameter defines the object value when the left rocker is pressed. Visible only if "Function = 0...100 %"!
Value, right rocker (0 ... 100 %)	0...100	This parameter defines the object value when the right rocker is pressed. Visible only if "Function = 0...100 %"!
Value adjustment by long button-press	enabled disabled	If value adjustment by long button-press is enabled, the ETS shows further parameters. Value adjustment begins, when the button is held down for more than 5 s. In this case, the respective status LED flashes as a sign that a new telegram has been transmitted.
Starting value in case of value adjustment	Same as configured value Same as value after last adjustment Same as value from communication object	Value adjustment can begin with different starting values. "Same as configured value": After each long press, the push button sensor always starts with the value configured in the ETS. "Same as value after last adjustment": After a long press, the push button sensor starts with the value transmitted by itself or by another device with this group address as the last value. "Same as value from communication object": After a long press, the push button sensor starts with the value transmitted by itself or by another device with this group address as the last

		value. This parameter is only visible if "Value adjustment by long button-press = enabled"!
Direction of value adjustment	<p>Upwards</p> <p>Downwards</p> <p>Toggling (alternating)</p>	<p>With a long press, the push button sensor can either vary the values always in the same direction or it stores the direction of the last adjustment and reverses it on the next button-press. This parameter is only visible if "Value adjustment by long button-press = enabled"!</p>
Level size (1 ... 15)	1... 15	<p>In a value adjustment, the pushbutton sensor determines the new telegram value from the previous value and the preset level size. If the value falls below the lower limit of the adjustment range (0 or 0 %) or if it exceeds the upper limit (255 or 100%), the sensor adapts the level size of the last level automatically. This parameter is only visible if "Value adjustment by long button-press = enabled"!</p>
Time between two telegrams	<p>0.5 sec</p> <p>1 sec</p> <p>2 sec</p> <p>3 sec</p>	<p>This parameter defines the interval at which the push button sensor transmits new telegrams during a value adjustment. This parameter is only visible if "Value adjustment by long button-press = enabled"!</p>
Value adjustment with overflow	<p>Yes</p> <p>No</p>	<p>If value adjustment is to be effected without overflow (setting "No") and if the pushbutton sensor reaches the lower limit of the adjustment range (0 or 0 %) or the upper limit (255 or 100 %) during value adjustment, the adjustment will be stopped automatically by the sensor. If the value adjustment with overflow is programmed (setting "Yes") and if the push button sensor reaches the lower or the upper limit, it will transmit the value of this range limit and then add a pause the duration of which corresponds to two levels. Thereafter, the push button sensor transmits a telegram with the value of the other range limit and continues the value adjustment in the same direction.</p>

The following parameters are only valid for the rocker function "Value transmitter 2-byte"...

Function	Temperature value transmitter	
	Brightness value transmitter	A rocker configured as "Value transmitter 2 byte" permits selecting whether the values to be transmitted are to be interpreted as temperature values (0 °C to 40 °C), as brightness values (0 lux to 1500 lux) or as integers (0 to 65535). The following parameters and their settings depend on this selection.
	Value transmitter (0 ... 65535)	
Temperature value (0 ... 40 °C) Left rocker	0... 20 ...40	This parameter defines the object value when the left rocker is pressed. This is only visible if "Function = Temperature value transmitter"!
Temperature value (0 ... 40 °C) Right rocker	0... 20 ...40	This parameter defines the object value when the right rocker is pressed. This is only visible if "Function = Temperature value transmitter"!
Brightness value Left rocker	0, 50, ... 300 ... 1450, 1500 lux	This parameter defines the object value when the left rocker is pressed. This is only visible if "Function = Brightness value transmitter"!
Brightness value Right rocker	0, 50, ... 300 ... 1450, 1500 lux	This parameter defines the object value when the right rocker is pressed. This is only visible if "Function = Brightness value transmitter"!
Value (0 ... 65535) Left rocker	0 ... 65535	This parameter defines the object value when the left rocker is pressed. This is only visible if "Function = Value transmitter (0 ... 65535)"!
Value (0 ... 65535) Right rocker	0 ... 65535	This parameter defines the object value when the right rocker is pressed. This is only visible if "Function = Value transmitter (0 ... 65535)"!
Value adjustment by long button-press	enabled disabled	If value adjustment by long button-press is enabled, the ETS shows further parameters. Value adjustment begins, when the button is held down for more than 5 s. In this case, the respective status LED flashes as a sign that a new telegram has been transmitted.

Starting value in case of value adjustment	<p>Same as configured value</p> <p>Same as value after last adjustment</p> <p>Same as value from communication object</p>	<p>Value adjustment can begin with different starting values.</p> <p>"Same as configured value": After each long press, the push button sensor always starts with the value configured in the ETS.</p> <p>"Same as value after last adjustment": After a long press, the push button sensor starts with the value transmitted by itself or by another device with this group address as the last value.</p> <p>"Same as value from communication object": After a long press, the push button sensor starts with the value transmitted by itself or by another device with this group address as the last value. This setting selectable only if "Functionality = Value transmitter (0...65535)!"</p> <p>This parameter is only visible if "Value adjustment by long button-press = enabled"!</p>
Direction of value adjustment	<p>Upwards</p> <p>Downwards</p> <p>Toggling (alternating)</p>	<p>With a long press, the push button sensor can either vary the values always in the same direction or it stores the direction of the last adjustment and reverses it on the next button-press. This parameter is only visible if "Value adjustment by long button-press = enabled"!</p>
Level size	<p>1 °C</p>	<p>For temperature values the level size of the adjustment is permanently set to 1 °C.</p> <p>This parameter is only visible if "Function = Temperature value transmitter" and "Value adjustment by long button-press = enabled"!</p>
Level size	<p>50 lux</p>	<p>For brightness values, the level size of the adjustment is fixed to 50 lux.</p> <p>This parameter is only visible if "Function = Brightness value transmitter" and "Value adjustment by long button-press = enabled"!</p>
Level size	<p>1</p> <p>2</p> <p>5</p> <p>10</p> <p>20</p> <p>50</p>	<p>This parameter sets the level size of the value adjustment for the 2-byte value transmitter.</p> <p>This parameter is only visible if "Function = Value transmitter (0 ... 65535)" and "Value adjustment by long</p>

	<p>75 100 200 500 750 1000</p>	button-press = enabled"
Time between two telegrams	<p>0.5 sec 1 sec 2 sec 3 sec</p>	<p>This parameter defines the interval at which the push button sensor transmits new telegrams during a value adjustment. This parameter is only visible if "Value adjustment by long button-press = enabled"</p>
Value adjustment with overflow	<p>Yes No</p>	<p>If value adjustment is to be effected without overflow (setting "No") and if the pushbutton sensor reaches the lower limit of the adjustment range (0°C, 0 lux, 0) or the upper limit (40°C, 1500 lux, 65535) during value adjustment, the adjustment will be stopped automatically by the sensor. If the value adjustment with overflow is programmed (setting "Yes") and if the push button sensor reaches the lower or the upper limit, it will transmit the value of this range limit and then add a pause the duration of which corresponds to two levels. Thereafter, the push button sensor transmits a telegram with the value of the other range limits and continues the value adjustment in the same direction.</p>

The following parameters are only valid for the rocker function "Scene extension"...

Function	<p>Scene extension without storage function</p> <p>Scene extension with storage function</p> <p>Recall of internal scene extension without storage function</p> <p>Recall of internal scene with storage function</p>	<p>This parameter defines the functionality of the extension. If the push button sensor is used as a scene extension, the scenes can either be stored in one or in several other KNX/EIB devices (e.g. light scene push button sensor). During a scene recall or in a storage function, the push button sensor transmits a telegram with the respective scene number via the extension object of the rocker. During the recall of an internal scene, a scene stored internally in the push button sensor is recalled or stored again. In this case, the sensor transmits no telegram to the bus via a scene extension object. For this setting, the internal scene function must be enabled.</p>
----------	--	--

<p>Scene number (1 ... 64) Left rocker</p>	<p>1...64</p>	<p>In accordance with the KNX standard, objects with data type 18.001 "Scene Control" can recall or store up to 64 scenes by their numbers. The parameter defines the scene number to be transmitted when a left button is pressed.</p>
<p>Scene number (1 ... 64) Right rocker</p>	<p>1...64</p>	<p>In accordance with the KNX standard, objects with data type 18.001 "Scene Control" can recall or store up to 64 scenes by their numbers. The parameter defines the scene number to be transmitted when a right button is pressed.</p>
<p>Scene number (1 ... 8) Left rocker</p>	<p>1...8</p>	<p>This parameter defines the number of the internal scene which is recalled or stored when a left button is pressed.</p>
<p>Scene number (1 ... 8) Right rocker</p>	<p>1...8</p>	<p>This parameter defines the number of the internal scene which is recalled or stored when a right button is pressed.</p>

The following parameters are only valid for the rocker function "2-channel operation"...

<p>Operation concept</p>	<p>Channel 1 or channel 2 Channel 1 and channel 2</p>	<p>This parameter defines the 2-channel operation concept. If the setting "Channel 1 or channel 2" is selected, the push button sensor decides dependent on the button-press duration which of the channels will be used. If the setting "Channel 1 and channel 2" is selected, the push button sensor transmits only the telegram of channel 1 on a short button-press and both telegrams on a sustained button-press.</p>
<p>Function channel 1 (2)</p>	<p>No function Switching (1 bit) Value transmitter 0 ... 255 (1-byte) Value transmitter 0 ... 100 % (1-byte) Temperature value transmitter (2-bytes)</p>	<p>This parameter defines the channel function and specifies which other parameters and which communication object are to be displayed for channel 1 (2).</p>

Command of the button for channel 1 (2) Left rocker	ON OFF TOGGLE	This parameter defines the object value transmitted to the bus, when the left-hand rocker is pressed. This is only visible if "Function channel 1 (2) = Switching (1 bit)"!
Command of the button for channel 1 (2) Right rocker	ON OFF TOGGLE	This parameter defines the object value transmitted to the bus, when the right-hand rocker is pressed. This is only visible if "Function channel 1 (2) = Switching (1 bit)"!
Value of the button for Channel 1 (2) Left rocker (0...255)	0...255	This parameter defines the object value transmitted to the bus, when the left-hand rocker is pressed. It is only visible if "Function channel 1 (2) = Value transmitter 0...255 (1 byte)"!
Value of the button for Channel 1 (2) Right rocker (0...255)	0...255	This parameter defines the object value transmitted to the bus, when the right-hand rocker is pressed. It is only visible if "Function channel 1 (2) = Value transmitter 0...255 (1 byte)"!
Value of the button for Channel 1 (2) Left rocker (0 ... 100 %)	0...100	This parameter defines the object value transmitted to the bus, when the left-hand rocker is pressed. It is only visible if "Function channel 1 (2) = Value transmitter 0...100 % (1-byte)"!
Value of the button for Channel 1 (2) Right rocker (0 ... 100 %)	0...100	This parameter defines the object value transmitted to the bus, when the right-hand rocker is pressed. It is only visible if "Function channel 1 (2) = Value transmitter 0...100 % (1-byte)"!
Temperature value of the button for channel 1 (2) Left rocker (0 ... 40 °C)	0...40	This parameter defines the temperature value transmitted to the bus when the left-hand rocker is pressed. It is only visible if "Function channel 1 (2) = Temperature value transmitter (2 bytes)"!
Temperature value of the button for channel 1 (2) Right rocker (0 ... 40 °C)	0...40	This parameter defines the temperature value transmitted to the bus when the right-hand rocker is pressed. It is only visible if "Function channel 1 (2) = Temperature value transmitter (2 bytes)"!

<p>Time between channel 1 and channel 2 Left rocker (1 ... 255 x 100 ms)</p>	<p>0...30...255</p>	<p>Depending on the selected operation concept, this parameter defines the interval at which the push button transmits the telegram for channel 1 and the telegram for channel 2 when the left side of the rocker is pressed.</p>
<p>Time between channel 1 and channel 2 Right rocker (1 ... 255 x 100 ms)</p>	<p>0...30...255</p>	<p>Depending on the selected operation concept, this parameter defines the interval at which the push button transmits the telegram for channel 1 and the telegram for channel 2 when the right side of the rocker is pressed.</p>
<p>Full-surface operation</p>	<p>enabled disabled</p>	<p>When the full-surface operation is enabled, the ETS shows the following parameters. Full-surface operation can only be programmed if "Operation concept = Channel 1 or channel 2"!</p>
<p>Function for full-surface operation</p>	<p>Switching Scene recall without storage function Scene recall with storage function</p>	<p>In case of full-surface operation, this parameter defines the function that is to be used. The ETS shows the corresponding communication object and the other parameters. If the push button sensor is to recall a scene with storage function by full-surface actuation, it will make a distinction between a brief press (less than 1 s), a sustained press (longer than 5 s) and an invalid button-press (between 1 s and 5 s). A brief press recalls the scene, a sustained press stores a scene and an invalid full-surface operation is ignored. This parameter is visible only if "Full-surface actuation = enabled"!</p>
<p>Command for full-surface operation</p>	<p>ON OFF TOGGLE</p>	<p>This parameter defines the value of the transmitted telegram when a full-surface operation has been sensed. "TOGGLE" changes over the current object value. This parameter is visible only if "Full-surface actuation = enabled"!</p>
<p>Scene number (1 ... 64)</p>	<p>1, 2, ..., 64</p>	<p>This parameter defines the scene number which is to be transmitted to the bus after a scene recall or during storage of a scene. This parameter is visible only if "Full-</p>

surface actuation = enabled"!

The following parameters are only valid for the rocker switch function "manual fan control"...

<p>Command on pressing rocker</p>	<p>Left: Increase level / Right: Decrease level</p> <p>Left: Decrease level Right: Increase level /</p>	<p>The manual fan control makes it possible to control the fan of a fan coil, independent of the command value specification of a room temperature controller. This enables requirements-oriented ventilation of a room in any desired, manually specified fan level. With the push button sensor 3 plus, manual control of the fan is possible via a rocker switch / push button function. The fan controller distinguishes between Automatic and Manual operation. Manual operation and thus also the switchover of the fan operating mode is possible by pressing a button on the device. This parameter defines the switching level presetting when a button is pressed with manual fan control. It should be noted that the manual fan control is only effective if the function has been enabled globally on the "Display" parameter page.</p>
-----------------------------------	--	--

☐☐ Rocker 2 (Buttons 3/4) ... Rocker n, see Rocker 1!

☐☐ Push button sensor -> Button 1 (only if "Function of buttons 1 and 2 = as separate buttons"!)

<p>Text for push button assistance function</p>	<p>Button 1 push button assistance function, free text with up to 30 characters</p>	<p>The push button assistance text is parameterised here. The maximum length of the push button assistance text is 30 characters. Each time a button is pressed, the ETS plug-in checks the pixel character spacing of the letter that has been entered, and if necessary limits the text being entered to the length that can be displayed. If no text is input, the push button assistance for the button or rocker switch in question is inactive. This parameter is only visible if the "Push button assistance function" parameter on the "Display" parameter page is set to "Activated".</p>
---	--	--

<p>Function</p>	<p>No function Switching Dimming Venetian blind 1-byte value transmitter 2-byte value transmitter Scene extension 2-channel operation Controller extension</p>	<p>This parameter defines the basic function of the button. Depending on this setting, the ETS displays different communication objects and parameters for this button.</p>
-----------------	---	---

Controller operation
 Heating timer operation
 Manual fan control

The following parameters are only valid for the push button function "Switching"...

Command on pressing the button	No reaction ON OFF TOGGLE	These parameters specify the reaction when the button is pressed or released.
Command on releasing the button	No reaction ON OFF TOGGLE	

The following parameters are only valid for the push button function "Dimming"...

Command on pressing the button	Brighter (ON) Darker (OFF) Brighter / darker (TOGGLE) Brighter (TOGGLE) Darker (TOGGLE)	This parameter defines the reaction when the button is pressed. If the push button sensor is to toggle on a brief press, the corresponding switching objects of other sensors with the same function must be linked with one another.
--------------------------------	--	---

Time between switching and dimming (100 ... 50000 x 1 ms)	100 ... 400 ... 50000	This parameter defines how long the button must be pressed for the push button sensor to transmit a dimming telegram.
--	------------------------------	---

Advanced parameters	Activated Deactivated	When the advanced parameters are activated, the ETS shows the following parameters.
---------------------	---------------------------------	---

Advanced parameters activated...

Increase brightness by	1.5 % 3 % 6 % 12.5 % 25 % 50 % 100 %	This parameter sets the relative dimming level when the brightness is increased. On each button-press, the brightness is changed at maximum by the configured level. Especially with smaller dimming levels it is advisable for the push button sensor to repeat the dimming telegrams automatically (see "telegram repetition").
------------------------	---	---

Reduce brightness by	1.5 % 3 % 6 % 12.5 % 25 %	This parameter sets the relative dimming level when the brightness is reduced. On each button-press, the brightness is changed at maximum by the configured level.
----------------------	---------------------------------------	--

	50 % 100 %	Especially with smaller dimming levels it is advisable for the push button sensor to repeat the dimming telegrams automatically (see "telegram repetition").
Transmit stop telegram?	Yes No	On "Yes" the push button sensor transmits a telegram for stopping the dimming process when the rocker is released. When the push button sensor transmits telegrams for dimming in smaller levels, the stop telegram is generally not needed.
Telegram repeat?	Yes No	This parameter can be used to activate telegram repetition for dimming. With the button held down, the push button sensor will then transmit the relative dimming telegrams (in the programmed level width) until the button is released.
Time between two telegrams	200 ms 300 ms 400 ms 500 ms 750 ms 1 sec 2 sec	This parameter defines the interval at which the dimming telegrams are automatically repeated in the telegram repetition mode. This parameter is visible only if "Telegram repetition = Yes"!
The following parameters are only valid for the push button function "Venetian blind"...		
Command on pressing the button	DOWN UP TOGGLE	This parameter defines the running direction of a drive after a button-press. If the setting is "TOGGLE", the direction is changed after each long time command. If several push buttons are to control the same drive, the long time objects of the push buttons must be interlinked for a correct change of the running direction.
Operation concept	short – long – short long – short short – long long – short or short	For Venetian blind control, four different operation concepts can be selected. For these concepts, the ETS shows further parameters.
Time between short-time and long-time	1 ... 4 ... 3000	This parameter sets the time after which the long time operation will be evaluated on pressing the top (or left-hand) button

command
(1 ... 3000 x 100 ms)

of the rocker.
This parameter is not visible with
"Operation concept = long – short"!

Slat adjusting time
(0 ... 3000 x 100 ms)

0 ... **5** ... 3000

Time during which a transmitted long time telegram can be terminated by releasing the top (or left-hand) button of the rocker (short time). This function serves to adjust the slats of a blind. This parameter is not visible with "Operation concept = long – short"!

The following parameters are only valid for the push button function "value transmitter 1 byte"...

Function

Value transmitter 0 ... 255
Value transmitter
0 ... 100 %

A button configured as "Value transmitter 1 byte" permits selecting whether the values to be transmitted are interpreted as integers from 0 to 255 or as a percentage from 0 % to 100 %. The following parameters and their settings depend on this distinction.

Value (0 ... 255)

0...255

This parameter defines the object value when the button is pressed.
Visible only if "Function = 0...255"!

Value (0 ... 100 %)

0...100

This parameter defines the object value when the button is pressed.
Visible only if "Function = 0...100 %"!

Value adjustment by
long button-press

enabled
disabled

If value adjustment by long button-press is enabled, the ETS shows further parameters.
Value adjustment begins, when the button is held down for more than 5 s. In this case, the respective status LED flashes as a sign that a new telegram has been transmitted.

Starting value in case of
value adjustment

Same as configured value
Same as value after last
adjustment
**Same as value from
communication object**

Value adjustment can begin with different starting values.
"Same as configured value": After each long press, the push button sensor always starts with the value configured in the ETS.
"Same as value after last adjustment": After a long press, the push button sensor starts with the value transmitted by itself or by another device with this group address as the last value.
"Same as value from communication object": After a long press, the push

		<p>button sensor starts with the value transmitted by itself or by another device with this group address as the last value. This parameter is only visible if "Value adjustment by long button-press = enabled"!</p>
Direction of value adjustment	<p>Upwards</p> <p>Downwards</p> <p>Toggling (alternating)</p>	<p>With a long press, the push button sensor can either vary the values always in the same direction or it stores the direction of the last adjustment and reverses it on the next button-press. This parameter is only visible if "Value adjustment by long button-press = enabled"!</p>
Level size (1 ... 15)	<p>1...15</p>	<p>In a value adjustment, the pushbutton sensor determines the new telegram value from the previous value and the preset level size. If the value falls below the lower limit of the adjustment range (0 or 0 %) or if it exceeds the upper limit (255 or 100%), the sensor adapts the level size of the last level automatically. This parameter is only visible if "Value adjustment by long button-press = enabled"!</p>
Time between two telegrams	<p>0.5 sec</p> <p>1 sec</p> <p>2 sec</p> <p>3 sec</p>	<p>This parameter defines the interval at which the push button sensor transmits new telegrams during a value adjustment. This parameter is only visible if "Value adjustment by long button-press = enabled"!</p>
Value adjustment with overflow	<p>Yes</p> <p>No</p>	<p>If value adjustment is to be effected without overflow (setting "No") and if the pushbutton sensor reaches the lower limit of the adjustment range (0 or 0 %) or the upper limit (255 or 100 %) during value adjustment, the adjustment will be stopped automatically by the sensor. If the value adjustment with overflow is programmed (setting "Yes") and if the push button sensor reaches the lower or the upper limit, it will transmit the value of this range limit and then add a pause the duration of which corresponds to two levels. Thereafter, the push button sensor transmits a telegram with the value of the other range limit and continues the value adjustment in the same direction.</p>

The following parameters are only valid for the push button function "value transmitter 2 byte"...

Function	Temperature value transmitter	A button configured as "Value transmitter 2 byte" permits selecting whether the values to be transmitted are to be interpreted as temperature values (0 °C to 40 °C), as brightness values (0 lux to 1500 lux) or as integers (0 to 65535). The following parameters and their settings depend on this selection.
	Brightness value transmitter	
	Value transmitter (0 ... 65535)	
Temperature value (0 ... 40 °C)	0... 20 ...40	This parameter defines the object value when the button is pressed. This is only visible if "Function = Temperature value transmitter"!
Brightness value	0, 50, ... 300 ... 1450, 1500 lux	This parameter defines the object value when the button is pressed. This is only visible if "Function = Brightness value transmitter"!
Value (0 ... 65535)	0 ... 65535	This parameter defines the object value when the button is pressed. This is only visible if "Function = Value transmitter (0 ... 65535)"!
Value adjustment by long button-press	enabled disabled	If value adjustment by long button-press is enabled, the ETS shows further parameters. Value adjustment begins, when the button is held down for more than 5 s. In this case, the respective status LED flashes as a sign that a new telegram has been transmitted.
Starting value in case of value adjustment	Same as configured value Same as value after last adjustment Same as value from communication object	Value adjustment can begin with different starting values. "Same as configured value": After each long press, the push button sensor always starts with the value configured in the ETS. "Same as value after last adjustment": After a long press, the push button sensor starts with the value transmitted by itself or by another device with this group address as the last value. "Same as value from communication object": After a long press, the push button sensor starts with the value transmitted by itself or by another device

		with this group address as the last value. This setting selectable only if "Function = Value transmitter (0...65535)"! This parameter is only visible if "Value adjustment by long button-press = enabled"!
Direction of value adjustment	<p>Upwards</p> <p>Downwards</p> <p>Toggling (alternating)</p>	With a long press, the push button sensor can either vary the values always in the same direction or it stores the direction of the last adjustment and reverses it on the next button-press. This parameter is only visible if "Value adjustment by long button-press = enabled"!
Level size	1 °C	For temperature values the level size of the adjustment is permanently set to 1 °C. This parameter is only visible if "Function = Temperature value transmitter" and "Value adjustment by long button-press = enabled"!
Level size	50 lux	For brightness values, the level size of the adjustment is fixed to 50 lux. This parameter is only visible if "Function = Brightness value transmitter" and "Value adjustment by long button-press = enabled"!
Level size	<p>1</p> <p>2</p> <p>5</p> <p>10</p> <p>20</p> <p>50</p> <p>75</p> <p>100</p> <p>200</p> <p>500</p> <p>750</p> <p>1000</p>	This parameter sets the level size of the value adjustment for the 2-byte value transmitter. This parameter is only visible if "Function = Temperature value transmitter" and "Value adjustment by long button-press = enabled"!
Time between two telegrams	<p>0.5 sec</p> <p>1 sec</p> <p>2 sec</p> <p>3 sec</p>	This parameter defines the interval at which the push button sensor transmits new telegrams during a value adjustment. This parameter is only visible if "Value adjustment by long button-press = enabled"!

Value adjustment with overflow	Yes No	<p>If value adjustment is to be effected without overflow (setting "No") and if the pushbutton sensor reaches the lower limit of the adjustment range (0°C, 0 lux, 0) or the upper limit (40°C, 1500 lux, 65535) during value adjustment, the adjustment will be stopped automatically by the sensor.</p> <p>If the value adjustment with overflow is programmed (setting "Yes") and if the push button sensor reaches the lower or the upper limit, it will transmit the value of this range limit and then add a pause the duration of which corresponds to two levels. Thereafter, the push button sensor transmits a telegram with the value of the other range limits and continues the value adjustment in the same direction.</p>
--------------------------------	------------------	--

The following parameters are only valid for the push button function "scene extension"...

Function	<p>Scene extension without storage function</p> <p>Scene extension with storage function</p> <p>Recall of internal scene extension without storage function</p> <p>Recall of internal scene with storage function</p>	<p>This parameter defines the functionality of the extension.</p> <p>If the push button sensor is used as a scene extension, the scenes can either be stored in one or in several other KNX/EIB devices (e.g. light scene push button sensor). During a scene recall or in a storage function, the push button sensor transmits a telegram with the respective scene number via the extension object of the rocker.</p> <p>During the recall of an internal scene, a scene stored internally in the push button sensor is recalled or stored again. In this case, the sensor transmits no telegram to the bus via a scene extension object. For this setting, the internal scene function must be enabled.</p>
Scene number (1 ... 64)	1...64	<p>In accordance with the KNX standard, objects with data type 18.001 "Scene Control" can recall or store up to 64 scenes by their numbers. The parameter defines the scene number to be transmitted when the button is pressed.</p>
Scene number (1 ... 8)	1...8	<p>This parameter defines the number of the internal scene which is recalled or stored when a button is pressed.</p>

The following parameters are only valid for the push button function "2-channel operation"...

Operation concept	Channel 1 or channel 2 Channel 1 and channel 2	This parameter defines the 2-channel operation concept. If the setting "Channel 1 or channel 2" is selected, the push button sensor decides dependent on the button-press duration which of the channels will be used. If the setting "Channel 1 and channel 2" is selected, the push button sensor transmits only the telegram of channel 1 on a short button-press and both telegrams on a sustained button-press.
Function channel 1 (2)	No function Switching (1 bit) Value transmitter 0 ... 255 (1-byte) Value transmitter 0 ... 100 % (1-byte) Temperature value transmitter (2-bytes)	This parameter defines the channel function and specifies which other parameters and which communication object are to be displayed for channel 1 (2).
Command of the button for channel 1 (2)	ON OFF TOGGLE	This parameter defines the object value transmitted to the bus when the button is pressed. This is only visible if "Function channel 1 (2) = Switching (1 bit)"!
Value of the button for Channel 1 (2) (0 ... 255)	0...255	This parameter defines the object value transmitted to the bus when the button is pressed. It is only visible if "Function channel 1 (2) = Value transmitter 0...255 (1 byte)"!
Value of the button for Channel 1 (2) (0 ... 100 %)	0...100	This parameter defines the object value transmitted to the bus when the button is pressed. It is only visible if "Function channel 1 (2) = Value transmitter 0...100 % (1 byte)"!
Temperature value of the button for channel 1 (2) (0 ... 40 °C)	0...20...40	This parameter defines the temperature value transmitted to the bus when the button is pressed. It is only visible if "Function channel 1 (2) = Temperature value transmitter (2 bytes)"!
Time between channel 1 and channel 2 (1 ... 255 x 100 ms)	0...30...255	Depending on the selected operation concept, this parameter defines the interval at which the push button

transmits the telegram for channel 1 and the telegram for channel 2 when the button is pressed.

The following parameters are only valid for the push button function "Controller extension"...

Function	<p>Operating mode switchover</p> <p>Forced oper. mode switchover</p> <p>Presence button</p> <p>Setpoint shift</p>	<p>A controller extension can optionally switch over the operating mode with normal or high priority, change the presence state or change the current room temperature value. With regard to the setting of this parameter, the ETS shows further parameters.</p>
Operating mode when the following button is pressed	<p>Comfort mode</p> <p>Standby mode</p> <p>Night mode</p> <p>Frost/heat protection mode</p> <p>Comfort mode -></p> <p>Standby mode -></p> <p>Comfort mode -></p> <p>Night mode -></p> <p>Standby mode -></p> <p>Night mode -></p> <p>Comfort mode -></p> <p>Standby mode -></p> <p>Night mode -></p>	<p>If the controller extension is to switch over the operating mode of the room temperature controller with normal priority, the extension can – when actuated – either activate a defined mode of operation or change over between different modes of operation.</p> <p>In order for this change to work properly, the controller extension should request the current state of the extension objects after a reset or after re-programming (set parameter under "General" to "Value request from controller extension = Yes").</p> <p>This parameter is only visible if "Function = operating mode switchover"!</p>
Forced operating mode when the following button is pressed	<p>Auto (Normal operating mode switchover)</p> <p>Comfort mode</p> <p>Standby mode</p> <p>Night mode</p> <p>Frost/heat protection mode</p> <p>Comfort mode -></p> <p>Standby mode -></p> <p>Comfort mode -></p> <p>Night mode -></p> <p>Standby mode -></p>	<p>If the controller extension is to switch over the operating mode of the room temperature controller with high priority, the extension can – when actuated – either enable the switchover with normal priority (auto), switch on a defined mode of operation with a high priority or change over between different operating modes.</p> <p>In order for this change to work properly, the controller extension should request the current state of the extension objects after a reset or after re-programming (set parameter under "General" to "Value request from controller extension = Yes").</p> <p>This parameter is only visible if "Function = forced operating mode"</p>

	Night mode ->	switchover"!
	Comfort mode -> Standby mode -> Night mode ->	
	Auto -> Comfort mode ->	
	Auto -> Standby mode ->	
	Auto -> Night mode ->	
	Auto -> Frost/heat protection mode ->	
Presence function when the following button is pressed	Presence OFF Presence ON Presence TOGGLE	On pressing a key, the controller extension can switch the presence state of the room temperature controller either on or off in a defined way or change over between both states ("Presence TOGGLE"). In order for this switchover to work properly, the controller extension should request the current state of the extension objects after a reset or after re-programming (set parameter under "General" to "Value request from controller extension? = Yes"). This parameter is only visible if "Function = presence button"!
Setpoint shift on pressing the button	Reduce setpoint value (level size) Increase setpoint value (level size)	This parameter defines the direction of the setpoint shift on the extension. For a setpoint value shift, the controller extension makes use of the two communication objects "Setpoint shift specification" and "Current setpoint shift". The "Current setpoint shift" communication object informs the extension about the current state of the room temperature controller. Based on this value and the respective parameter, the controller extension determines the new level size which it transmits via the "Setpoint shift specification" communication object to the room temperature controller. This parameter is only visible if "Function = Setpoint shift"!

The following parameters are only valid for the pushbutton function "Controller operation"...

push button function	<p>Presence button</p> <p>Setpoint shift</p> <p>Operating mode switchover</p>	<p>The "Controller operation" push button function can be used to control the internal room temperature controller. The room temperature controller of the push button sensor 3 plus offers different ways of influencing the room temperature control.</p> <p>"Operating mode switchover": Switching over between different modes of operation with different setpoint temperatures assigned to each mode by the controller.</p> <p>"Presence status": Signalling the presence of a person in a room. The signalling may also be combined with a configured switchover in the mode of operation. Pressing a button switches over the presence status. This push button function may only be used if the presence detection is configured to "Presence button" on the "Controller functionality" parameter page.</p> <p>"Setpoint shift": Readjustment of the setpoint temperature in levels which are referred in each case to the configured setpoint temperature of the current operating mode. A setpoint shift is only possible if the controller is configured in the ETS to relative temperature setpoints (derivation from basic setpoint)! With absolute setpoint temperature presetting the push button sensor does not execute the "Setpoint shift" push button function.</p>
----------------------	--	--

Setpoint shift on pressing the button	<p>Reduce setpoint value (level size)</p> <p>Increase setpoint value (level size)</p>	<p>This parameter defines the direction of the setpoint shift.</p> <p>This parameter is only visible if "Push button function = Setpoint shift"!</p>
Operating mode when the following button is pressed	<p>Comfort mode</p> <p>Standby mode</p> <p>Night operation</p> <p>Frost/heat protection mode</p>	<p>This parameter is used to specify the operating mode that should be called up in the controller when pressing the button with normal priority.</p> <p>This parameter is only visible if "Push button function = operating mode switchover"!</p>

The following parameters are only valid for the push button function "heating timer operation"...

push button function	<p>Deactivate heating timer</p> <p>Activate heating timer</p> <p>Activate/deactivate heating timer (TOGGLE)</p>	<p>Heating timer operation facilitates demand-driven activation or deactivation of the heating timer integrated in the device. The heating timer implements the automatic switchover of the controller operating mode depending on</p>
----------------------	--	--

the time of day and the day of the week. Up to 28 separate switching times are available for this in the device. Pressing a button configured as "Heating timer operation" switches over the state of the heating timer (activated <-> deactivated). It should be noted that the heating timer operation is only effective if the function has been enabled globally on the "Room temperature control -> Heating timer" parameter page.

The following parameters are only valid for the pushbutton function "manual fan control"...

Command on pressing the button	Increase fan level	The manual fan control makes it possible to control the fan of a fan coil, independent of the command value specification of a room temperature controller. This enables requirements-oriented ventilation of a room in any desired, manually specified fan level. With the push button sensor 3 plus, manual control of the fan is possible via a rocker switch / push button function. The fan controller distinguishes between Automatic and Manual operation. Manual operation and thus also the switchover of the fan operating mode is possible by pressing a button on the device. This parameter defines the switching level presetting when a button is pressed with manual fan control. It should be noted that the manual fan control is only effective if the function has been enabled globally on the "Display" parameter page.
	Decrease fan level	

☐ Button 2 ... Button n, see Button 1!

☐ Push button sensor -> button / rocker x -> button / rocker x - status-LED

Function of left / right status LED	always OFF	Irrespective of the push button or rocker function, the status LED is switched off permanently.
	Always ON	Irrespective of the pushbutton or rocker function, the status LED is switched on permanently.
	Button-press display	The status LED indicates a button actuation. The ON time is set on the parameter page "General" in common for all status LEDs that are configured as actuation displays.

Telegram acknowledgment	The status LED indicates the transmission of a telegram in 2-channel operation. This setting can only be configured for the push button or rocker function "2-channel operation".
Status display (switching object)	The status LED indicates the state of the communication object "Switching". If the object value is "ON", the status LED is illuminated. If the object value is "OFF" the status LED is switched off. This setting can only be configured for the push button or rocker function "Switching" or "Dimming".
Inverted status display (switching object)	The status LED indicates the state of the communication object "Switching". If the object value is "OFF", the status LED is illuminated. If the object value is "ON" the status LED is switched off. This setting can only be configured for the push button or rocker function "Switching" or "Dimming".
Activation via separate LED object	The status LED indicates the state of its own, separate 1-bit LED object. This setting causes the additional parameter "Activation of the status LED via object value" to be shown.
Operating mode display (KNX controller)	The status LED indicates the state of a KNX room temperature controller via a separate 1-byte communication object. This setting causes the additional parameter "Status LED ON with" to be shown.
Controller status indication	The status LED indicates the state of the room temperature controller or the controller extension. The display information is derived from the object for the controller status. The display information is derived from the object for the controller status. This setting causes the additional parameter "Status LED ON with" to be shown.
Setpoint value shift display	The status LED indicates the state of a setpoint shift in case of main controller and controller extension operation. This setting causes the additional parameter "Status LED" to be shown. This setting can only be configured in the pushbutton function "Controller extension" or "Controller operation" and with the button function "Setpoint shift".
Button function active display	Depending on the function of the associated button, the status LED indicates the operating mode (for controller operation), the state of the presence button or the heating timer. The LED lights up if the presence function, the operating mode or the

<p>Button function inactive display</p>	<p>heating timer is activated. The LED is off if the presence function, the operating mode or the heating timer is inactive. This setting only functions for the push button functions "Controller extension - presence button" (functions as "Presence button" and "Operating mode switchover"), and "Heating timer operation".</p>
<p>Comparator without sign (1-byte)</p>	<p>Depending on the function of the associated button, the status LED indicates the operating mode (for controller operation), the state of the presence button or the heating timer. The LED lights up if the presence function, the operating mode or the heating timer is inactive. The LED is off if the presence function, the operating mode or the heating timer is activated. This setting only functions for the push button functions "Controller extension - presence button" (functions as "Presence button" and "Operating mode switchover"), and "Heating timer operation".</p>
<p>Comparator with sign (1-byte)</p>	<p>The status LED is activated depending on a comparison. In this configuration there is a separate 1-byte communication object available via which the unsigned reference value (0...255) is received. This setting causes the additional parameter "Status LED ON with" to be shown.</p> <p>The status LED is activated depending on a comparison. In this configuration there is a separate 1-byte communication object available via which the positive or negative reference value (-128...127) is received. This setting causes the additional parameter "Status LED ON with" to be shown.</p>
	<p>The display parameters "Possible LED functions" on the parameter pages of the status LEDs show the specific LED functions that can be configured. If LED functions other than the possible ones are configured, the affected status LEDs will not have any function during subsequent operation of the push button sensor (always OFF).</p>

The function of the status LED = "Display via separate LED"

object"...

Activation of the status LED via object value

**1 = LED static ON /
0 = LED static OFF**

1 = LED static OFF /
0 = LED static ON

1 = LED flashes /
0 = LED static OFF

1 = LED static OFF /
0 = LED flashes

If the "Function of status LED ..." is set to "Control via separate LED object", then the telegram polarity of the 1-bit object "Status LED" can be specified at this point.

The LED can be switched on or off statically. In addition, the received switching telegram can be evaluated in such a way that the LED flashes.

If the function of status LED = "Operating mode display (KNX controller)"...

Status LED ON with

Automatic mode
Comfort mode
Standby mode
Night mode
Frost/heat protection mode

The values of a communication object with data type 20.102 "HVAC Mode" are defined as follows:

0 = Automatic
1 = Comfort
2 = Standby
3 = Night
4 = Frost/heat protection

The value "Automatic" is used only by the "forced operating mode switchover" objects.

The status LED is illuminated when the object receives the value configured here.

The function of the status LED = "Controller status indication"...

Status LED ON with

Comfort mode
Standby mode
Night mode
Frost/heat protection mode
Controller disabled
Heating / cooling
Controller inactive
Frost alarm

This parameter is used to define which information about the controller status is to be indicated by the LED. The settings "Controller inactive" and "Frost alarm" cannot be displayed if the controller status is set to "KNX compliant"!

If the function of status LED = "Comparator without sign"...

Status LED ON with	Reference value greater than received value	The status LED indicates whether the configured reference value is greater or less than or equal to the value of the "Status LED" object".
	Reference value less than received value	
	Reference value equal to received value	
Reference value (0 ... 255)	0...255	This parameter defines the reference value to which the value of the "Status LED" object is compared.
If the function of status LED = "Comparator with sign"...		
Status LED ON with	Reference value greater than received value	The status LED indicates whether the configured reference value is greater or less than or equal to the value of the "Status LED" object".
	Reference value less than received value	
	Reference value equal to received value	
Reference value (-128 ... 127)	-128...0...127	This parameter defines the reference value to which the value of the "Status LED" object is compared.
With "Colour selection of all status LEDs" = "Colour selection per rocker switch/button"...		
Colour or the status LED	red green blue	If separate colour settings for the status LEDs are required, then this parameter can be used individually to define the desired colour for each status LED. The LED lights up in the configured colour if it is subsequently switched on regularly in operation of the push button sensor in accordance with the basic configuration "Function of the status LED". This parameter is only visible if the parameter "Colour selection of all status LEDs" on parameter page "General" is set to "Colour selection per rocker switch/button".

Superposed function	enabled disabled	With separate colour setting it is additionally possible to configure a superposed function separately for each status LED. The superposed function can be used change the colour of a status LED via a communication object during operation of the device. It is also possible here to change the display function. The superposed function of a status LED is enabled when this parameter is configured to "enabled".
Colour of the status LED for superposed function	red green blue	If the superposed function is enabled, this parameter can be used to define the desired superposed colour. The LED lights up in the configured colour if the superposed function is later activated in operation of the push button sensor. This parameter is only visible if the parameter "Superposed function" is set to "enabled".
Selection of the superposed LED function	Activation via separate LED object	With the superposed function the status LED indicates the state of a separate 1-bit LED object. This setting causes the additional parameter "Activation of the status LED via object value" to be shown.
	Comparator without sign (1-byte)	In the superposed function the status LED is activated depending on a comparison. In this configuration there is a separate 1-byte communication object available via which the unsigned reference value (0...255) is received. This setting causes the additional parameter "Superposed function ON with" to be shown.
	Comparator with sign (1-byte)	In the superposed function the status LED is activated depending on a comparison. In this configuration there is a separate 1-byte communication object available via which the positive or negative reference value (-128...127) is received. This setting causes the additional parameter "Superposed function ON with" to be shown.
Activation of the status LED via object value	1=superp. funct. ON / 0=superp. funct. OFF 1 = superposed Funct. OFF / 0 = superposed Funct. ON	If the "Selection of the superposed LED function" is set to "Activation via separate LED object", this parameter can be used to specify the telegram polarity of the "Superposed polarity" 1-bit object of the status LED

	<p>1 = superposed Funct. flashes / 0 = superposed Funct. OFF</p> <p>1 = superposed Funct. OFF / 0 = superposed Funct. flashes</p>	<p>concerned. The superposed function can be switched on or off statically. In addition, the received switching telegram can be evaluated in such a way that the LED flashes when a superposed function is active.</p>
Superposed function ON when	<p>Reference value greater than received value</p> <p>Reference value less than received value</p> <p>Reference value equal to received value</p>	<p>In the superposed function the status LED indicates whether the configured reference value is greater or less than or equal to the value of the "Superposed value function" object. This parameter is only visible when "Selection of the superposed LED function" = "Comparator without sign" / "Comparator with sign".</p>
Reference value (0 ... 255)	0...255	<p>This parameter defines the reference value to which the value of the "Superposed value function" object is compared. This parameter is only visible when "Selection of the superposed LED function" = "Comparator without sign".</p>
Reference value (-128 ... 127)	-128...0...127	<p>This parameter defines the reference value to which the value of the "Superposed value function" object is compared. This parameter is only visible when "Selection of the superposed LED function" = "Comparator with sign".</p>
<p><input type="checkbox"/> push button sensor -> Disable</p> <p>Disabling function?</p>	<p>Yes</p> <p>No</p>	<p>With this parameter, the disabling function of the push button sensor can be centrally activated. If "Yes", the ETS shows further communication object and parameters.</p>
Polarity of disabling object	<p>Disable = 1 / Enable = 0</p> <p>Disable = 0 / Enable = 1</p>	<p>This parameter defines the value of the disabling object at which the disabling function is active.</p>

<p>Button assignment of the buttons for disabling function</p>	<p>All buttons assigned Individual buttons assigned</p>	<p>In an active disable, either all buttons of the device or only individual buttons may be affected by the disable. This can be used to limit the control function of the push button sensor completely or only partially. Setting "All buttons assigned": The disabling function affects all buttons. As soon as any button of the device is pressed while a disabling function is active, the "Behaviour when a disabling function is active" is executed. In this configuration the display buttons are also disabled if the parameter "Behaviour when a disabling function is active" is set to "No response when pressed" (see below). Otherwise the display buttons are not disabled. "Individual buttons assigned" setting: the disabling function affects only the buttons that are assigned on the "Disable - Button selection" parameter page. As soon as one of the assigned buttons is pressed while a disabling function is active, the "Behaviour when a disabling function is active" for this button is executed. All other, non-disabled buttons respond normally when pressed.</p>
<p>Behaviour when the disabling function is active</p>	<p>No reaction to button-press Reaction to a button-press like...</p>	<p>This parameter can be used to set whether disabled buttons have no response when pressed, or alternatively whether they respond like a different button of the device or like a virtual disabling function. Setting "No reaction to button-press": The disabled buttons do not respond when pressed. Setting "Reaction to a button-press like...": All buttons assigned to the disabling function behave as defined in the parameters for the two specified reference buttons of the push button sensor. Different or identical buttons can be configured separately for all the right and left operating buttons. The two virtual disabling functions of the push button sensor can also be configured as a reference button. The telegrams are transmitted to the bus via the communication objects of the specified reference buttons.</p>
<p>All assigned right buttons behave as</p>	<p>Button 1 Button 2 ... (Selection depends on</p>	<p>If a specific button function is to be assigned during disabling to all or to individual buttons, this parameter can be used to select the desired button the</p>

	device variant!)		function of which will then be executed. During disabling, all the right buttons behave like the one configured here. The desired functions can either correspond to the function of an existing button or they can be configured as special disabling functions. This parameter is only visible with "Behaviour when a disabling function is active" = "Reaction to a button-press like...!"
	Disabling function 1		
	Disabling function 2		
All assigned left buttons behave as	Button 1 Button 2 ... (Selection depends on device variant!)		If a specific button function is to be assigned during disabling to all or to individual buttons, this parameter can be used to select the desired button the function of which will then be executed. During disabling, all the left buttons behave like the one configured here. The desired functions can either correspond to the function of an existing button or they can be configured as special disabling functions. This parameter is only visible with "Behaviour when a disabling function is active" = "Reaction to a button-press like...!"
	Disabling function 1		
	Disabling function 2		

Push button sensor -> Disable -> Disable button selection

Selection of the buttons for the behaviour when the disabling function is active.

Button 1?	Yes No	The user can specify for each button separately whether it will be affected by the disabling function during the disabling state.
Button 2?	Yes No	

...

(Selection depends on device variant!)

Disable disabling function 1 / Disable disabling function 2

The functions "switching", "dimming", "Venetian blind", "1-byte value transmitter", "2-byte value transmitter", "scene extension", "2-channel operation" and "controller extension" are available for the two disabling functions. These functions behave exactly the same as the push button functions of the device (the same parameters).

<p>☐ push button sensor -> Alarm messages</p>		
Alarm signal display	<p>Activated</p> <p>Deactivated</p>	<p>This parameter can be used to enable alarm signal displaying.</p> <p>When alarm signalling is enabled, the ETS displays further parameters and up to two further communication objects.</p>
Polarity of the alarm signalling object	<p>Alarm when ON and Alarm reset when OFF</p> <p>Alarm when OFF and Alarm reset when ON</p>	<p>The alarm signalling object is used as an input for activating or deactivating alarm signal displaying.</p> <p>If the object value corresponds to the "Alarm" state, all status LEDs, the operation LEDs / backlighting flash with a frequency of approx. 2 Hz.</p> <p>If the setting is "Alarm when OFF and alarm reset when ON", the object must first be actively written by the bus with "0" to activate the alarm after a reset.</p> <p>An alarm signal is not stored so that the alarm signalling is generally deactivated after a reset or after programming with the ETS.</p>
Reset alarm signalling by a button-press?	<p>yes</p> <p>No</p>	<p>If this parameter is set to "Yes", active alarm signal displaying can be deactivated by a button-press on the push button sensor.</p> <p>This button-press does not cause the configured function of the pressed button to be executed. Only after then next button-press will the configuration of the button be evaluated and a telegram be transmitted to the bus, if applicable.</p> <p>If "No" has been selected, alarm signalling can only be deactivated via the alarm signalling object. A button-press will always execute the configured button function.</p>
Use the alarm acknowledge object?	<p>Yes</p> <p>No</p>	<p>If alarm signalling can be deactivated by a button-press, this parameter defines whether an additional alarm acknowledge telegram is to be transmitted to the bus via the separate object "Alarm signalling acknowledge" after triggering by this button-press.</p> <p>A telegram can, for instance, be sent via this object to the "Alarm signalling" objects of other push button sensors in order to reset the alarm status there as</p>

Acknowledge alarm
signalling by

OFF telegram
ON telegram

well (observe the polarity of the
acknowledge object!).

This parameter sets the polarity of the
"Alarm signalling acknowledge" object.
This parameter presetting depends on
the selected polarity of the alarm
message object.

4.2.5.3 Parameter for the controller function section

Description	Values	Comment
<input type="checkbox"/> Room temperature control		
Room temperature controller function		The controller function block integrated in the device can either work as a main controller or, alternatively, as a controller extension. The setting of this parameter has a major impact on the function and on the other parameters and objects displayed in the ETS.
	Switched-off	The controller function block is switched off completely. No room temperature control and controller extension function can be executed by the device.
	Switched-on	The controller function block works as a main controller. The internal control algorithm is active, meaning that the device can be used for single-room temperature control.
	Controller extension	The controller function block works as a controller extension. A controller extension itself is not involved in the regulating process. With it, the user can operate the single-room controller, i.e. the main controller from different places in the room. Any number of controller extensions can be controlled by a main controller.
<input type="checkbox"/> Room temperature control (addition for controller extension)		
Value request from controller extension?	Yes No	To ensure that all the objects are updated correctly, some communication objects of the controller extension can also initialise automatically after a device restart. For this, this parameter can be set to "Yes". The update then takes place after a reset by means of a ValueRead telegram to the room temperature controller. This must answer the request with a ValueResponse telegram.
Controller status	KNX compliant Controller general	Besides the operating function, the controller extension also possesses a display function. As on the main controller, various items of status information of the temperature controller can be shown on the device display. As the displayed states and information on the parameterisation of the main controller, the controller extension must also be configured and thus match the functions of the main controller. The controller extension requires the

		status information of the main controller; it derives this either from the KNX compliant controller status or the general controller status. This parameter defines how the main controller prepares the status information. If should be ensured that the setting matches that of the main controller.
Upward adjustment of the basic setpoint temperature (0...10) * 1 K	0 K + 1 K + 2 K + 3 K + 4 K + 5 K + 6 K + 7 K + 8 K + 9 K + 10 K	For the controller extension to be able to evaluate and operate the setpoint shift correctly, the extension must also be configured and matched to the functions of the main controller. This function match is carried out using the "Upward adjustment of basic setpoint temperature" and "Downward adjustment of basic setpoint temperature" parameters. These parameters must agree with the settings of the parameters of the same name in the main controller. These parameters are only relevant if the main controller is working with relative setpoint presetting (basic setpoint). The parameters have no effect with absolute setpoint presetting.
Downward adjustment of the basic setpoint temperature (-10...0) * 1 K	0 K - 1 K - 2 K - 3 K - 4 K - 5 K - 6 K - 7 K - 8 K - 9 K - 10 K	
Step width of the setpoint shift	0.1 K 0.5 K 1.0 K	This parameter defines the value of a level of the basic setpoint shift. The controller extension must work with the same step width as the main controller. This parameter is only available in the application version 1.2.
<input type="checkbox"/> Room temperature control -> Controller general		
Control circuits	1 control circuit 2 control circuits	The controller can work with one or alternatively with two control circuits. Control with one control circuit: If you use only one control circuit you can parameterize the "heating", "cooling" or, as an alternative, the mixed "heating and cooling" operating modes. You can also use additional stages in any cases. In this connection, you can set different

control algorithms for the heating and/or cooling system. Thus, you can use up to four separate algorithms for two-stage heating or cooling operation. Control with two control circuits: If you use two control circuits you can only choose between the "heating" or "cooling" operating modes. In this connection, both control circuits will always work in the same operating mode (comfort, standby, etc.). However, you can set different control algorithms for both control circuits. For this type of parameterization, the use of two-stage control is not intended. Both control circuits can alternatively work with joint or with separate set values.

Operating mode	<p>Heating</p> <p>Cooling</p> <p>heating and cooling</p> <p>Basic and additional heating</p> <p>Basic and additional cooling</p> <p>Basic and additional heating and cooling</p>	<p>The room temperature controller distinguishes between two different operating modes. The operating modes specify whether you want the controller to use its variable to trigger heating systems ("heating" single operating mode) or cooling systems ("cooling" single operating mode). You can also activate mixed operation, with the controller being capable of changing over between "Heating" and "Cooling" either automatically or, alternatively, controlled by a communication object. In addition, you can establish two-level control operation to control an additional heating or cooling unit. For two-level feedback control, separate command values will be calculated as a function of the temperature deviation between the setpoint and the actual value and transmitted to the bus for the basic and additional levels. This parameter specifies the operating mode and, if necessary, enables the additional level(s). If you use two control circuits you can only choose between the "heating" or "cooling" mode.</p>
Additional level disabling object	<p>Yes</p> <p>No</p>	<p>The additional levels can be separately disabled via the bus. The parameter enables the disable object as necessary. This parameter is only visible in two-level heating and cooling operation.</p>
Send variable heating and cooling to one common object	<p>Yes</p> <p>No</p>	<p>If the parameter is set to "Yes", the command value will be transmitted on a shared object during heating or cooling. This function is used, if the same heating system is used to cool the room</p>

		in the summer and used to heat the room in the winter. This parameter is only visible with "heating and cooling" mixed operating mode, if applicable, with additional levels.
Type of heating control (if applicable, for basic and additional level and for a second control circuit)	<p>Continuous PI control</p> <p>Switching PI control (PWM)</p> <p>Switching 2-point control (ON/OFF)</p>	Selecting a control algorithm (PI or 2-point) with data format (1-byte or 1-bit) for the heating system.
Type of heating (if applicable, for basic and additional level and for a second control circuit)	<p>Hot water heater (5 K / 150 min)</p> <p>Underfloor heating (5 K / 240 min)</p> <p>Electric heating (4 K / 100 min)</p> <p>Fan convector (4 K / 90 min)</p> <p>Split unit (4 K / 90 min)</p> <p>via control parameter</p>	Adapting the PI algorithm to different heating systems using predefined values for the proportional range and reset time control parameters. With the "Via control parameters" setting, it is possible to set the control parameters in a manner deviating from the predefined values within specific limits. This parameter is only visible if "Type of heating control = Continuous PI control".
Proportional range heating (10 ... 127) * 0.1 K	10... 50 ...127	Separate setting of the "Proportional range" control parameter. This parameter is only visible if "Type of heating = via control parameter" and the heating control type "PI control".
Reset time heating (0 ... 255) * 1 min; 0 = inactive	0... 50 ...255	Separate setting of the "Reset time" control parameter. This parameter is only visible if "Type of heating = via control parameter" and the heating control type "PI control".
Top hysteresis of 2-point cont. heating (5 ... 127) * 0.1 K	5 ...127	Definition of top hysteresis (switch-off temperatures) of the heating. This parameter is only visible if "Type of heating control = Switching 2-point feedback control (ON/OFF)".
	-128... -5	Definition of bottom hysteresis (switch-on temperatures) of the heating.

Lower hysteresis of 2-point cont. heating (-128 ... -5) * 0.1 K		This parameter is only visible if "Type of heating control = Switching 2-point feedback control (ON/OFF)".
Type of cooling control (if applicable, for basic and additional level and for a second control circuit)	Continuous PI control Switching PI control (PWM) Switching 2-point control (ON/OFF)	Selecting a feedback control algorithm (PI or 2-point) with data format (1 byte or 1 bit) for the cooling system
Type of cooling (if applicable, for basic and additional level and for a second control circuit)	Cooling ceiling (5 K / 240 min) Electric heating (4 K / 100 min) Fan convector (4 K / 90 min) Split unit (4 K / 90 min) via control parameter	Adapting the PI algorithm to different cooling systems using predefined values for the proportional range and reset time control parameters. With the "Via control parameters" setting, it is possible to set the control parameters in a manner deviating from the predefined values within specific limits. This parameter is only visible if "Type of cooling control = PI control".
Proportional range heating (10 ... 127) * 0.1 K	10... 50 ...127	Separate setting of the "Proportional range" control parameter. This parameter is only visible if "Type of cooling = via control parameter" and the cooling control type "PI control".
Reset time heating (0 ... 255) * 1 min; 0 = inactive	0... 150 ...255	Separate setting of the "Reset time" control parameter. This parameter is only visible if "Type of cooling = via control parameter" and the cooling control type "PI control".
Top hysteresis of 2-point cont. cooling (5 ... 127) * 0.1 K	5 ...127	Definition of top hysteresis (switch-on temperatures) of the cooling. This parameter is only visible if "Type of cooling control = Switching 2-point feedback control (ON/OFF)".
Lower hysteresis of 2-point cont. heating (-128 ... -5) * 0.1 K	-128... -5	Definition of bottom hysteresis (switch-off temperatures) of the cooling. This parameter is only visible if "Type of cooling control = Switching 2-point feedback control (ON/OFF)".
Operating mode switchover	Via value (1 byte) Via switching (4 x 1 bit)	In the setting "Via value (1-byte) the switchover of the operating modes via the bus takes place according to the

		KNX specification via a 1-byte value object. In addition, a higher-ranking forced-object is available for this setting. In the setting "Via switching (4 x 1 bit)" the 'classic' switchover of the operating modes via the bus is via four separate 1-bit objects.
Operation mode after reset	<p>Restore operation mode before reset</p> <p>Comfort mode</p> <p>Standby mode</p> <p>Night operation</p> <p>Frost/heat protection mode</p>	<p>This parameter specifies which operating mode is set immediately after a device reset.</p> <p>With "Restore operation mode before reset": The mode set before a reset according to the operating mode object, heating timer or push button function (normal priority) will be restored after the initializing phase of the device.</p> <p>Operating modes set by a function with a higher priority before the reset (Forced, Window status, Presence status) are not effected. Frequent changing of the operating mode (e. g. several times a day) during running operation can adversely affect the life of the device as the read-only memory (EEPROM) used has been designed for less frequent write access events only.</p>
Frost/heat protection	<p>Automatic frost protection</p> <p>Via window status</p>	<p>Here it is possible to determine how the room temperature regulator switches into the frost/heat protection.</p> <p>With "automatic frost protection": the automatic frost protection is activated. Depending on the room temperature this allows an automatic switchover into the frost protection mode.</p> <p>With "Via window status": switchover into the frost/heat protection takes place via the "window status" object.</p>
Automatic frost protection temperature drop	<p>Off</p> <p>0.2 K / min.</p> <p>0.3 K / min.</p> <p>0.4 K / min.</p> <p>0.5 K / min.</p> <p>0.6 K / min.</p>	<p>This parameter determines the decrease temperature by which the room temperature has to decrease within one minute in order for the controller to switch into the frost protection mode. The "OFF" setting will deactivate the frost protection automatic. Only visible if "frost/heat protection = Automatic frost protection"!</p>
Frost protection period in automatic mode (1...255) * 1 min.	1... 20 ...255	<p>The length of the automatic frost protection is defined here. After the preset time has elapsed, the controller will return to the operating mode which was set before frost protection. Re-</p>

		triggering will not be possible. Only visible if "frost/heat protection = Automatic frost protection"!
Window status delay (0...255) * 1 min; 0 = inactive	0...255	This parameter defines the delay time for the window status. After the parameterised time has elapsed after the window is opened the window status will be changed and thus the frost/heat protection mode activated. Such delay can make sense if short ventilation of the room by opening the window is not supposed to change the operating mode. Only visible if "frost/heat protection = Via window status"!
<p>□- Room temperature control -> Controller general -> Command value and status output</p>		
Automatic transmission at modification by (0...100) * 1 %; 0 = inactive	0...3...100	This parameter determines the size of the command value change that will automatically transmit continuous command value telegrams via the command value objects. Thus this parameter only affects command values which are configured to "Continuous PI control" and to the 1 byte additional command value objects of the "Switching PI control (PWM)".
Cycle time of the switching command value (1...255) * 1 min	1...15...255	This parameter specifies the cycle time for the pulse width modulated command value (PWM). Thus this parameter only affects command values which are configured to "Switching PI control (PWM)".
Cycle time for automatic transmission (0...255) * 1 min; 0 = inactive	0...10...255	This parameter determines the time interval for the cyclical transmission of the command values via all command value objects.
Output of the heating command value	Inverted (under current, this means closed) Normal (under current, this means opened)	At this point, it is possible to specify whether the command value telegram for heating is output normally or in inverted form. This parameter is only visible if the operating mode "Heating" or "Heating and cooling" is configured and not two-level operation.
	Inverted (under current, this means closed)	At this point, it is possible to specify whether the command value telegram

Output of the heating basic level command value	Normal (under current, this means opened)	for the heating basic level is output normally or in inverted form. This parameter is only visible if the operating mode "Heating" or "Heating and cooling" is configured along with two-level operation.
Output of the heating additional level command value	Inverted (under current, this means closed) Normal (under current, this means opened)	At this point, it is possible to specify whether the command value telegram for the heating additional level is output normally or in inverted form. This parameter is only visible if the operating mode "Heating" or "Heating and cooling" is configured along with two-level operation.
Output of the heating command value control circuit 1	Inverted (under current, this means closed) Normal (under current, this means opened)	At this point, it is possible to specify whether the command value telegram for heating of the first control circuit is output normally or in inverted form. This parameter is only visible if the operating mode "Heating" and two control circuits are configured.
Output of the heating command value control circuit 2	Inverted (under current, this means closed) Normal (under current, this means opened)	At this point, it is possible to specify whether the command value telegram for heating of the second control circuit is output normally or in inverted form. This parameter is only visible if the operating mode "Heating" and two control circuits are configured.
Output of the cooling command value	Inverted (under current, this means closed) Normal (under current, this means opened)	At this point, it is possible to specify whether the command value telegram for cooling is output normally or in inverted form. This parameter is only visible if the operating mode "Cooling" or "Heating and cooling" is configured and not two-level operation.
Output of the cooling basic level command value	Inverted (under current, this means closed) Normal (under current, this means opened)	At this point, it is possible to specify whether the command value telegram for the cooling basic level is output normally or in inverted form. This parameter is only visible if the operating mode "Cooling" or "Heating and cooling" is configured along with two-level operation.
	Inverted (under current, this means closed)	At this point, it is possible to specify whether the command value telegram

Output of the cooling additional level command value	Normal (under current, this means opened)	for the cooling additional level is output normally or in inverted form. This parameter is only visible if the operating mode "Cooling" or "Heating and cooling" is configured along with two-level operation.
Output of the cooling command value in control circuit 1	Inverted (under current, this means closed) Normal (under current, this means opened)	At this point, it is possible to specify whether the command value telegram for cooling of the first control circuit is output normally or in inverted form. This parameter is only visible if the operating mode "Cooling" and two control circuits are configured.
Output of the cooling command value in control circuit 2	Inverted (under current, this means closed) Normal (under current, this means opened)	At this point, it is possible to specify whether the command value telegram for cooling of the second control circuit is output normally or in inverted form. This parameter is only visible if the operating mode "Cooling" and two control circuits are configured.
Command value limit	Deactivated continuously activated can be activated via object	The command value limit allows the restriction of calculated command values to the range limits "minimum" and "maximum". The limits are permanently set in the ETS and, if command value limitation is active, can be neither undershot or exceeded during device operation. The "Command value limit" parameter defines the mode of action of the limiting function. The command value limit can either be activated or deactivated using the 1-bit communication object "Command value limit", or be permanently active.
Command value limit after reset	Deactivated Activated	When controlling via the object, it is possible to have the controller activate the command value limit automatically after bus voltage return or an ETS programming operation. This parameter defines the initialisation behaviour here. In the "Deactivated" setting, the command value limit is not automatically activated after a device reset. A "1" telegram must first be received via the "Command value limit" object for the limit to be activated. In the "Activated" setting, the controller activates the command value limit automatically after a device reset. To deactivate the limit a "0" telegram must

<p>Minimum command value for heating (optionally control circuit 1) (optionally also for basic and additional level)</p>	<p>5%, 10%, 15%, 20%, 25%, 30%, 35%, 40%, 45%, 50%</p>	<p>be received via the "Command value limit" object. The limit can be switched on or off at any time using the object. This parameter is only visible with "Command value limit = can be activated via object"!</p>
<p>Maximum command value for heating (optionally control circuit 1) (optionally also for basic and additional level)</p>	<p>55%, 60%, 65%, 70%, 75%, 80%, 85%, 90%, 95%, 100%</p>	<p>The "Maximum command value" parameter specifies the upper command value limiting value for heating. With an active command value limit, the set maximum command value is not exceeded. If the controller calculates larger command values, it sets the configured maximum command value.</p>
<p>Minimum command value for heating Control circuit 2</p>	<p>5%, 10%, 15%, 20%, 25%, 30%, 35%, 40%, 45%, 50%</p>	<p>The "Minimum command value" parameter specifies the lower command value limiting value for heating. With an active command value limit, the set minimum command value is not undershot by command values. If the controller calculates smaller command values, it sets the configured minimum command value. The controller transmits a 0 % command value if no more heating or cooling energy has to be demanded. This parameter is only visible with two control circuits!</p>
<p>Maximum command value for heating Control circuit 2</p>	<p>55%, 60%, 65%, 70%, 75%, 80%, 85%, 90%, 95%, 100%</p>	<p>The "Maximum command value" parameter specifies the upper command value limiting value for heating. With an active command value limit, the set maximum command value is not exceeded. If the controller calculates larger command values, it sets the configured maximum command value. This parameter is only visible with two control circuits!</p>

<p>Minimum command value for cooling (optionally control circuit 1) (optionally also for basic and additional level)</p>	<p>5%, 10%, 15%, 20%, 25%, 30%, 35%, 40%, 45%, 50%</p>	<p>The "Minimum command value" parameter specifies the lower command value limiting value for cooling. With an active command value limit, the set minimum command value is not undershot by command values. If the controller calculates smaller command values, it sets the configured minimum command value. The controller transmits a 0 % command value if no more heating or cooling energy has to be demanded.</p>
<p>Maximum command value for cooling (optionally control circuit 1) (optionally also for basic and additional level)</p>	<p>55%, 60%, 65%, 70%, 75%, 80%, 85%, 90%, 95%, 100%</p>	<p>The "Maximum command value" parameter specifies the upper command value limiting value for cooling. With an active command value limit, the set maximum command value is not exceeded. If the controller calculates larger command values, it sets the configured maximum command value.</p>
<p>Minimum command value for cooling Control circuit 2</p>	<p>5%, 10%, 15%, 20%, 25%, 30%, 35%, 40%, 45%, 50%</p>	<p>The "Minimum command value" parameter specifies the lower command value limiting value for cooling. With an active command value limit, the set minimum command value is not undershot by command values. If the controller calculates smaller command values, it sets the configured minimum command value. The controller transmits a 0 % command value if no more heating or cooling energy has to be demanded. This parameter is only visible with two control circuits!</p>
<p>Maximum command value for cooling Control circuit 2</p>	<p>55%, 60%, 65%, 70%, 75%, 80%, 85%, 90%, 95%, 100%</p>	<p>The "Maximum command value" parameter specifies the upper command value limiting value for cooling. With an active command value limit, the set maximum command value is not exceeded. If the controller calculates larger command values, it sets the configured maximum command value. This parameter is only visible with two control circuits!</p>
<p>Heating message</p>	<p>Yes No</p>	<p>Depending on the set operating mode, a separate object can be used to signal whether the controller for the first control</p>

		circuit is currently demanding heating energy and is thus actively heating. The "Yes" setting here enables the message function for heating.
Cooling message	Yes No	Depending on the set operating mode, a separate object can be used to signal whether the controller for the first control circuit is currently demanding cooling energy and is thus actively cooling. The "Yes" setting here enables the message function for cooling.
Controller status	No status KNX compliant Controller general Transmit individual state	The room temperature controller can transmit its current status to the KNX/EIB. A choice of data formats is available for this. This parameter enables the status signal and sets the status format.
Single status	Comfort mode Active Standby mode activated Night mode activated Frost/heat protection active Controller disabled Heating / cooling Controller inactive Frost alarm	Here, the status information is defined, which is to be transmitted onto the bus as the 1-bit controller status. This parameter is only visible if the parameter "Controller status" is set to "Transmit single status".
Behaviour when command value = 100% (Clipping mode)	keep 100% until setpoint = actual, then 0% keep 100% as required, then adjust downwards	If with a PI control the calculated command value of the controller exceeds the physical limits of the actuator, in other words if the calculated command value is greater than 100%, then the command value is set to the maximum value (100%) and thus limited. With PI control the command value can reach the value "100%" if there is a large deviation of the room temperature from the setpoint temperature or the controller requires a long time to adjust to the setpoint with the heating or cooling energy that is being applied. The controller can

evaluate this state in a particular manner and react to it in various ways. This parameter defines the functions of the PI controller when the command value is 100%.

"keep 100% until setpoint = actual, then 0%" setting:

The controller keeps the maximum command value until the room temperature (actual value) reaches the setpoint temperature. After that it reduces the command value down to 0% all at once (controller reset). The advantage of this control behaviour is that in this way sustainable heating up of undercooled rooms or effective cooling of overheated rooms will be achieved by overshooting the setpoint. The disadvantage is that in some circumstances the overshooting of the room temperature may be found disturbing.

Setting "keep 100% as required, then adjust downwards":

The controller maintains the maximum command value only as long as it is necessary. After that it adjusts the command value downwards according to the PI algorithm. The advantage of this control characteristic is the fact that the room temperature does not exceed the setpoint temperature at all, or only slightly. The disadvantage is that this control principle increases the tendency to oscillate about the setpoint.

Room temperature control -> Controller general -> Setpoints

Overwrite setpoints in device after ETS programming operation? **Yes**
No

The temperature setpoints programmed in the room temperature controller by the ETS during commissioning can be changed during device operation locally in the configuration menu or via communication objects. This parameter can be used to define whether the setpoints present in the device, which may have been changed subsequently, are overwritten during an ETS programming operation and thus replaced again by the values parameterised in the ETS. If this parameter is on "Yes", then the temperature setpoints are deleted in the device during a programming operation and replaced by the values of the ETS. If this parameter is configured to "No", then setpoints present in the device remain unchanged. The setpoint temperatures entered in the ETS then

		have no significance.
Own setpoints for the second control circuit?	Yes No	When both control circuits are used, the second circuit can have its own setpoints. The "yes" setting will enable the setpoint presetting of the second control circuit. This parameter is visible when "control circuits = 2 control circuits"!
Setpoint presetting	Relative (setpoint temperatures from basic setpoint) Absolute (independent setpoint temperatures)	It is possible to configure the setpoints for the "Comfort", "Standby" and "Night" modes directly (absolute setpoint presetting) or relatively (derivation from basic setpoint). This parameter defines the way the setpoint temperature is preset. With "Relative": All temperature setpoints are derived from the basic temperature (basic setpoint). With "Absolute": The setpoint temperatures are independent of each other. Different temperature values can be specified for each operating mode and heating/cooling mode.
Basic temperature after reset (7.0 ... 40.0) * 1 °C	7.0... 21.0 ...40.0	This parameter defines the temperature value to be applied as the basic setpoint after commissioning by the ETS. All the temperature setpoints are derived from the basic setpoint. This parameter is only visible with relative setpoint presetting!
Accept change of the basic setpoint shift permanently	No Yes	In addition to the setting of individual temperature setpoints via the ETS, the user is able to shift the basic setpoint within a settable range anytime via local control or via the basic setpoint object, either using the display buttons or with the "Setpoint shift" push button function, if this is configured to a function button of the push button sensor. Whether a basic setpoint shifting only affects the currently active operating mode or whether it influences all other setpoint temperatures of the remaining operating modes is determined by this parameter. In the "Yes" setting, the shift of the basic setpoint carried out affects all operating modes. The shifting is maintained even after change-over of the operating mode or the heating/cooling mode or readjusting the basic setpoint. In the "No" setting, the basic setpoint

		<p>shift carried out is in effect for only as long as the operating mode or heating/cooling mode has not changed or the basic setpoint is maintained. Otherwise the setpoint shift will be reset to "0". This parameter is only visible with relative setpoint presetting!</p>
<p>Modification of the basic temperature setpoint value</p>	<p>Deactivated Permit via display buttons approve via bus approve on device and via bus</p>	<p>Here, it is possible to specify if it is possible to change the basic setpoint in the menu "Settings" on the device and/or via the bus. This parameter is only visible with relative setpoint presetting!</p>
<p>Modification of the basic temperature setpoint value Control circuit 2</p>	<p>Deactivated approve via bus</p>	<p>Here, it is possible to specify if it is possible to change the basic setpoint for the second control circuit via the bus. This parameter is only visible with relative setpoint presetting and with separate setpoint for the two control circuits!</p>
<p>Accept modification of the basic temperature setpoint value permanently?</p>	<p>No Yes</p>	<p>One has to distinguish between two cases, defined by this parameter, if the basic setpoint has been modified (via local control or via the object): This parameter is only visible with relative setpoint presetting!</p> <p>When set to "Yes": If, with this setting, the temperature setpoint is adjusted, the controller saves the value permanently to the EEPROM (permanent storage). The newly adjusted value will overwrite the initial value, i.e. the basic temperature originally configured via the ETS after a reset! The changed values are also retained after a device reset, after a switch-over of the operating mode or after a switch-over of the heating/cooling mode. With this setting, it should be noted that frequent changing of the basic temperature (e.g. several times a day because of cyclical telegrams) can affect the product life of the device as the non-volatile storage is designed for less frequent write access.</p> <p>When set to "No": The setpoints set on the room temperature controller or received via the objects remain active only temporarily. In case of a bus</p>

<p>Accept modification of the setpoint permanently?</p>	<p>No Yes</p>	<p>voltage failure or following a switch-over to another operating mode (e.g. Comfort followed by Standby, or also Comfort followed by Comfort), or after a switch-over of the heating/cooling mode (e.g. heating after cooling), the last setpoint changed will be discarded and replaced by the initial value.</p>
<p>Setpoint temp. comfort mode (heating) (7.0 °C...40.0 °C) (optionally also for the second control circuit)</p>	<p>7.0...21.0...40.0</p>	<p>One has to distinguish between two cases, defined by this parameter, if the setpoint has been modified via the object. This parameter is only visible with absolute setpoint presetting!</p> <p>When set to "Yes": If, with this setting, the temperature setpoint is adjusted, the controller saves the value permanently to the EEPROM (permanent storage). The newly adjusted value will overwrite the initial value, i.e. the absolute setpoint temperature originally loaded using the ETS. The changed values are also retained after a device reset, after a switch-over of the operating mode or after a switch-over of the heating/cooling mode (with absolute setpoint presetting individually for each operating mode for heating and cooling). With this setting, it should be noted that frequent changing of the basic temperature (e.g. several times a day because of cyclical telegrams) can affect the product life of the device as the non-volatile storage is designed for less frequent write access.</p> <p>When set to "No": The setpoints received via the objects remain active only temporarily. In case of a bus voltage failure or following a switch-over to another operating mode (e.g. Comfort followed by Standby, or also Comfort followed by Comfort), or after a switch-over of the heating/cooling mode (e.g. heating after cooling), the last setpoint changed will be discarded and replaced by the initial value.</p> <p>With absolute setpoint presetting the setpoint temperatures for comfort, standby and night mode are independent of each other. Depending on the operating mode and heating/cooling mode, various temperature values can be specified in the ETS within the range +7.0 °C to +40.0 °C. The ETS plug-in does not validate the temperature</p>

		<p>values. It is thus possible, for example, to select smaller setpoint temperatures for cooling mode than for heating mode, or to specify lower temperatures for comfort mode than for standby mode. After commissioning using the ETS the setpoint temperatures can be changed via the bus by means of temperature telegrams. This can be done using the communication object "Setpoint active operating mode".</p> <p>Presetting of the setpoint temperature for the comfort heating mode. These parameters are only visible with absolute setpoint presetting!</p> <p>Presetting of the setpoint temperature for standby mode (heating).</p>
Setpoint temp. standby mode (heating) (7.0 °C...40.0 °C) (optionally also for the second control circuit)	7.0... 19.0 ...40.0	
Setpoint temp. night mode (heating) (7.0 °C...40.0 °C) (optionally also for the second control circuit)	7.0... 17.0 ...40.0	Presetting of the setpoint temperature for night mode (heating).
Setpoint temp. comfort mode (cooling) (7.0 °C...40.0 °C) (optionally also for the second control circuit)	7.0... 23.0 ...40.0	Presetting of the setpoint temperature for standby mode (cooling).
Setpoint temp. standby mode (cooling) (7.0 °C...40.0 °C) (optionally also for the second control circuit)	7.0... 25.0 ...40.0	Presetting of the setpoint temperature for standby mode (cooling).
Setpoint temp. night mode (cooling) (7.0 °C...40.0 °C) (optionally also for the second control circuit)	7.0... 27.0 ...40.0	Presetting of the setpoint temperature for night mode (cooling).
Step width of the setpoint shift	0.1 K 0.5 K 1.0 K	This parameter defines the value of a level of the setpoint shift. With a setpoint shift, the basic setpoint (for relative setpoint specification) or the setpoint of the active operating mode (for absolute setpoint specification) is changed by one step in the positive or negative direction from the temperature value configured

		at this point. The controller module rounds the temperature values received via the "Basic Setpoint" or "Setpoint, active operating mode" object and matches the values to the step width configured here. This parameter is only available in the application version 1.2.
Standby temperature change	Deactivated Permit via display buttons	This parameter specifies whether the setpoint temperature for standby mode can be changed locally in the "Settings" menu. This parameter is only visible with relative setpoint presetting!
Night temperature change	Deactivated Permit via display buttons	This parameter specifies whether the setpoint temperature for night mode can be changed locally in the "Settings" menu. This parameter is only visible with relative setpoint presetting!
Frost protection setpoint temperature (7.0...40.0)	7.0...40.0	This parameter specifies the setpoint temperature for frost protection. The parameter is only visible in "Heating" or "Heating and cooling" operating modes (if necessary with additional levels).
Heat protection setpoint temperature (7.0...45.0)	7.0... 35.0 ...45.0	This parameter specifies the setpoint temperature for heat protection. The parameter is only visible in "Cooling" or "Heating and cooling" operating modes (if necessary with additional levels).
Deadband position	symmetrical asymmetrical	With relative setpoint presetting, the comfort setpoint temperatures for the operating mode "Heating and cooling" are derived from the basic setpoint in consideration of the adjusted Dead band. The deadband (temperature zone for which there is neither heating nor cooling) is the difference between the comfort setpoint temperatures. Symmetrical setting: the deadband preset in the ETS plug-in is divided in two parts at the basic setpoint. The comfort setpoint temperatures are derived directly from the basic setpoint resulting from the half deadband (Basic setpoint - 1/2 deadband = Heating comfort temperature or Basic setpoint + 1/2 deadband = Cooling comfort

		temperature).
		Asymmetrical setting: with this setting the comfort setpoint temperature for heating equals the basic setpoint! The preset deadband is effective only from the basic setpoint in the direction of comfort temperature for cooling. Thus the comfort set-temperature for cooling is derived directly from the comfort setpoint for heating. The parameter is only visible in the "Heating and cooling" operating mode (if necessary with additional levels) and only with relative setpoint presetting!
Deadband between heating and cooling (0...127) * 0.1 K	0... 20 ...127	With relative setpoint presetting, the comfort setpoint temperatures for heating and cooling are derived from the basic setpoint in consideration of the adjusted Dead band. The deadband (temperature zone for which there is neither heating nor cooling) is the difference between the comfort setpoint temperatures. It is set using this parameter. The parameter is only visible in the "Heating and cooling" operating mode (if necessary with additional levels) and only with relative setpoint presetting.
Dead band shift	Deactivated Permit via display buttons	This parameter determines whether the dead band and thus the comfort temperature for cooling may be adjusted on the device in in the "Settings" menu. This parameter is only visible with relative setpoint presetting!
Difference between basic and additional levels (0...127) * 0.1 K	0... 20 ...127	In a two-level control mode, it is necessary to determine the temperature difference to the basic level with which the additional level is to be incorporated into the feedback control. This parameter defines the level spacing. The parameter can only be seen in two-level control operation.
Transmission at setpoint temperature change by (0...255) * 0.1 K	0... 1 ...255	Determines the size of the value change required to automatically transmit the current value via the "Setpoint temperature" object. In the "0" setting, the setpoint temperature is not transmitted automatically when there is a change.

<p>Cyclical transmission of setpoint temperature (0...255) * 1 min; 0 = inactive</p>	<p>0...255</p>	<p>This parameter determines whether the setpoint temperature is to be transmitted periodically via the "Setpoint temperature" object. Definition of the cycle time by this parameter In the "0" setting, the setpoint temperature is not transmitted automatically cyclically.</p>
<p>Upward adjustment of the basic setpoint temperature (0...10) * 1 K</p>	<p>0 K + 1 K + 2 K + 3 K + 4 K + 5 K + 6 K + 7 K + 8 K + 9 K + 10 K</p>	<p>This is used to define the maximum range in which the basic setpoint temperature can be adjusted upwards. This parameter is only visible with relative setpoint presetting!</p>
<p>Downward adjustment of the basic setpoint temperature (0...10) * 1 K</p>	<p>0 K - 1 K - 2 K - 3 K - 4 K - 5 K - 6 K - 7 K - 8 K - 9 K - 10 K</p>	<p>This is used to define the maximum range in which the basic setpoint temperature can be adjusted downwards. This parameter is only visible with relative setpoint presetting!</p>
<p>Lower the setpoint temperature during standby operating mode (heating) (-128...0) * 0.1 K (optionally also for the control circuit 2)</p>	<p>-128...-20...0</p>	<p>The value by which the standby setpoint temperature for heating is lowered compared to the heating comfort temperature. The parameter is only visible in the "Heating" or "Heating and cooling" operating mode (if necessary with additional levels) and only with relative setpoint presetting.</p>
<p>Lower the setpoint temperature during Night mode (heating) (-128...0) * 0.1 K (optionally also for the control circuit 2)</p>	<p>-128...-40...0</p>	<p>The value by which the night setpoint temperature for heating is lowered compared to the heating comfort temperature. The parameter is only visible in the "Heating" or "Heating and cooling" operating mode (if necessary with additional levels) and only with relative setpoint presetting.</p>

<p>Raise the setpoint temperature during standby operating mode (cooling) (0...127) * 0.1 K (optionally also for the control circuit 2)</p>	<p>0...20...127</p>	<p>The value by which the standby setpoint temperature for cooling is lowered compared to the cooling comfort temperature. The parameter is only visible in the "Heating" or "Heating and cooling" operating mode (if necessary with additional levels) and only with relative setpoint presetting.</p>
<p>Raise the setpoint temperature during Night mode (cooling) (0...127) * 0.1 K (optionally also for the control circuit 2)</p>	<p>0...40...127</p>	<p>The value by which the night temperature for cooling is lowered compared to the cooling comfort temperature. The parameter is only visible in the "Heating" or "Heating and cooling" operating mode (if necessary with additional levels) and only with relative setpoint presetting.</p>
<p>Change-over between heating and cooling</p>	<p>Automatic Via object (heating/cooling change-over)</p>	<p>In a configured mixed mode it is possible to switch over between heating and cooling. With "Automatic": Depending on the operating mode and the room temperature, the change-over takes place automatically. With "Via object (heating/cooling change-over)": The change-over takes place only via the object "Heating / cooling change-over". With automatic setpoint presetting this parameter is permanently set to "Via object (heating/cooling switch-over)"!</p>
<p>Heating / cooling operating mode after reset</p>	<p>Heating Cooling Operating mode before reset</p>	<p>The preset operating mode for after the return of the bus voltage is specified here. Only visible if "Change-over between heating and cooling = via object"!</p>
<p>Automatic heating/cooling transmission switchover</p>	<p>On changing the operating mode On changing the output value</p>	<p>Here, it is possible to specify when a telegram is transmitted automatically onto the bus via the object "Heating / cooling change-over". Only visible if "Change-over between heating and cooling = automatic".</p>
<p>Cyclical transmission heating/cooling change-over</p>	<p>0...255</p>	<p>This parameter specifies whether the current object status of the "Heating / cooling change-over" object should be</p>

(0...255) * 1 min;
0 = inactive

output cyclically to the bus on an automatic change-over. The cycle time can be set here. The "0" setting deactivates the periodic transmission of the object value.
Only visible if "Change-over between heating and cooling = automatic".

□ Room temperature control -> Controller general -> Room temperature measurement

Temperature detection
(optionally control circuit
1)

Internal sensor

The "Temperature detection" parameter specifies the sensors to detect the room temperature. In the case to two control circuits the temperature detection of the two circuits can be configured to the various temperature sources independently of each other using separate parameters. In this manner, temperature detection of the control circuits can be either different or the same.

External sensor

received temperature value

Internal and external
sensor

internal sensor + received
temperature value

external sensor + received
temperature value

Setting "internal sensor": the temperature sensor integrated in the room temperature controller is activated. Thus, the actual temperature value is determined only locally on the device. In this parameterisation the feedback control will start directly after a device reset.

"External sensor" setting: The actual temperature is determined solely via the wired remote sensor connected to the flush-mounted bus coupling unit (see Accessories). If necessary its measured temperature value can if necessary be transmitted to the bus or read out via the 2-byte object "External sensor". In this parameterisation the feedback control will start directly after a device reset. It is important for a wired remote sensor to be connected!

"Received temperature value" setting; Actual temperature is determined solely via a temperature value received from the bus. In this case, the sensor must either be a KNX/EIB room thermostat coupled via the 2-byte object "Received temperature" or a controller extension with temperature detection. After a device reset the room temperature controller will first wait for a valid temperature telegram until the feedback control starts and a command value, if applicable, is output.

Setting "Internal and external sensor" or "Internal sensor + received temperature value" or "External sensor + received temperature value": these settings are

used to combine the selected temperature sources. The sensors can be either a remote sensor wired directly to the controller, or KNX/EIB room thermostats connected via the 2-byte object "Received temperature", or controller extensions with temperature detection. When the wired remote sensor (external sensor) is used, its insulated measured temperature value can if necessary be transmitted to the bus or read out via the 2-byte object "External sensor". After a device reset the room temperature controller will first wait for a valid temperature telegram until the feedback control starts and a command value, if applicable, is output.

Temperature detection
Control circuit 2

Internal sensor

External sensor

received temperature value

Internal and external
sensor

internal sensor + received
temperature value

external sensor + received
temperature value

Determination of
measured value from
internal / external ratio
(optionally control circuit
1)

10% to 90%
20% to 80%
30% to 70%
40% to 60%
50% to 50%
60% to 40%
70% to 30%
80% to 20%
90% to 10%

The weighting of the measured temperature value for the internal and external (wired) sensors is specified here. That results in an overall value, which will be used for the further interpretation of the room temperature. This parameter is only visible with "temperature recording = internal and external sensor".

Determination of
measured value from
internal / external ratio
Control circuit 2

10% to 90%
20% to 80%
30% to 70%
40% to 60%
50% to 50%
60% to 40%
70% to 30%
80% to 20%
90% to 10%

The weighting of the measured temperature value for the internal and external (wired) sensors for the second control circuit is specified here. That results in an overall value, which will be used for the further interpretation of the room temperature. This parameter is only visible with two controller circuits and with "temperature recording = internal and external sensor!"

Determination of
measured value must
be received internally

10% to 90%
20% to 80%
30% to 70%

The weighting of the measured temperature value for the internal sensor and the temperature value received from

(optionally control circuit 1)	40% to 60% 50% to 50% 60% to 40% 70% to 30% 80% to 20% 90% to 10%	the bus is specified here. That results in an overall value, which will be used for the further interpretation of the room temperature. This parameter is only visible with "temperature recording = internal sensor + received temperature value!
Determination of measured value must be received internally Control circuit 2	10% to 90% 20% to 80% 30% to 70% 40% to 60% 50% to 50% 60% to 40% 70% to 30% 80% to 20% 90% to 10%	The weighting of the measured temperature value for the internal sensor and the temperature value received from the bus is specified here for the second control circuit. That results in an overall value, which will be used for the further interpretation of the room temperature. This parameter is only visible with two control circuits and with "temperature recording = internal sensor + received temperature value!
Determination of measured value must be received externally (optionally control circuit 1)	10% to 90% 20% to 80% 30% to 70% 40% to 60% 50% to 50% 60% to 40% 70% to 30% 80% to 20% 90% to 10%	The weighting of the measured temperature value of the external (wired) sensor and the temperature value received from the bus is specified here. That results in an overall value, which will be used for the further interpretation of the room temperature. This parameter is only visible with "temperature recording = external sensor + received temperature value!
Determination of measured value must be received externally Control circuit 2	10% to 90% 20% to 80% 30% to 70% 40% to 60% 50% to 50% 60% to 40% 70% to 30% 80% to 20% 90% to 10%	The weighting of the measured temperature value of the external (wired) sensor and the temperature value received from the bus is specified here for the second control circuit. That results in an overall value, which will be used for the further interpretation of the room temperature. This parameter is only visible with two control circuits and with "temperature recording = external sensor + received temperature value!
Internal sensor calibration (-128...127) * 0.1 K	-128 ... 127, 0	Determines the value by which the internal sensor's room temperature value is calibrated. This parameter is only visible when the temperature recording system requires an internal sensor.
External sensor calibration (-128...127) * 0.1 K	-128 ... 127, 0	Determines the value by which the external sensor's room temperature value is calibrated.

		This parameter is only visible when the temperature recording system requires an external sensor.
Calibration of received temperature value (-128...127) * 0.1 K	-128 ... 127, 0	Determines the value by which the temperature value received from the bus is calibrated. This parameter is only visible when the temperature recording system requires that a temperature value is received.
Request time for received temperature value (0...255) * 1 min; 0 = inactive	0 ... 255, 0	The request time for the temperature value received from the bus is specified here. In the "0" setting, the temperature value is not automatically polled by the controller. In this case the communication partner (e.g. controller extension) must transmit its temperature value itself. This parameter is only visible when the temperature recording system requires that a temperature value is received.
Transmission when room temperature change by (0...255) * 0,1 K; 0 = inactive	0 ... 255, 3	Determines the size of the value change of the room temperature of the first control circuit after which the current values are automatically transmitted to the bus via the "Actual temperature" object.
Cyclical transmission of the room temperature (0...255) * 1 min; 0 = inactive	0 ... 255, 15	This parameter specifies whether and when the determined room temperature of the first control circuit is to be periodically output via the "Actual temperature" object.
Transmission on ext. sensor temp. change by (0...255) * 0,1 K; 0 = inactive	0 ... 255, 3	Determines the size of the value change of the temperature determined via the wired remote sensor, after which the current values are automatically transmitted to the bus via the "External sensor" object.
Cycl. transmission of the ext. sensor temp. (0...255) * 1 min; 0 = inactive	0 ... 255, 15	This parameter specifies whether and when the temperature determined using the wired remote sensor is to be periodically output via the "External sensor" object.

Room temperature measurement -> Controller functionality

Presence detection	<p>none</p> <p>Presence button</p> <p>Motion detector</p>	<p>In the "None" setting, the presence mode is deactivated.</p> <p>In the "Presence button" setting, presence detection takes place using a button on the device or via the presence object (e.g. other push button sensors). When the presence button is pressed from the night mode or frost/heat protection, the comfort extension is activated. If the presence button is pressing in standby mode, the controller activates the comfort mode for the duration of the presence mode.</p> <p>In the "Motion detector" setting, presence detection takes place using an external motion detector, coupled to the presence object. Comfort mode is recalled when a presence is detected. Comfort mode remains active until the motion detector ceases to detect movement. In this setting, a presence button on the device has no function.</p>
<p>Length of the comfort extension (0 .. 255) * 1 min; 0 = OFF</p>	0... 30 ...255	<p>When the presence button is pressed from the Night mode or Frost/heat protection, the controller switches to Comfort mode for the length of time specified here. When this time has elapsed, it switches back automatically. In the "0" setting, the comfort extension is switched off, meaning that it cannot be activated from Night or Frost/heat protection mode. In this case, the operating mode will not be changed, although the presence function has been activated.</p> <p>This parameter is only visible when presence detection is configured to "Presence button".</p>
<p>Operation of controller inhibitable</p>	<p>No</p> <p>always disabled</p> <p>Via bus</p>	<p>It is possible to disable the operation of the room temperature controller. If operation is disabled, the controller can no longer be operated using function buttons of the device, display buttons or the "Settings" menu. Operation via the bus, e.g. using the operating mode or setpoint objects, is still possible, however.</p> <p>This parameter can be used to determine whether the operation is never possible (setting: "always disabled" or whether it can be initiated via the "controller operation disable" object (setting: "via bus"). With the setting "via bus" the operation will be deactivated if a "1" telegram is received on the object. Hence, the operation will</p>

		be activated again after receiving a "0" telegram.
Switch off controller (dew point operation)	No Via bus	This parameter enables the "Disable controller" object. If the controller is disabled, there is no feedback control until enabled in both control circuits (command values = 0). An activated controller disable (dew point operation) is shown in the display.
Valve protection	No Yes	Valve protection may be carried out periodically in order to prevent the addressed control valves of the heater or cooling system from becoming calcified or stuck. The "Yes" setting in this parameter activates valve protection. This type of protection is generally started not only for non-active command value outputs, i.e. for outputs which have not requested any heating or cooling energy over the past 24 hours. For these outputs, the controller will periodically set the command value to the maximum value once a day for a duration of approx. 5 minutes.
□- Room temperature control -> Heating timer		
Heating timer	enabled disabled	The heating timer integrated into the device allows requirements-oriented switchover of the controller operating mode depending on the time of day and the day of the week. For this purpose, the device provides up to 28 separate switching times that can be preconfigured individually in the ETS, and can be modified subsequently via the settings menu while the push button sensor is in operation. In order to be able to use the heating timer in general, the function must be enabled using this parameter.
Disabling heating timer via bus?	Yes No	A disabling function allows the operating mode to be switched over by the heating timer, and can be activated temporarily, for example via the bus while on holiday. To facilitate the disabling function, set this parameter to "yes". In this case the 1-bit object "disable heating timer" will be enabled. The polarity of this disabling object can be parameterised. During an active disable function, the operating mode will not be switched-over by the

heating timer.

Polarity of the disabling object for the heating timer **not inverted (Disable = 1)**
 inverted (Disable = 0)

This parameter defines the telegram polarity of the disabling object for the heating timer.

Overwrite switching times present in device during download? **Yes**
 No

The switching programs of the timer will be loaded into the device and stored in permanent memory when the entire application program is programmed or when you are partially programming the parameters, if the ETS parameter "Overwrite switching times preset in device during download?" is set to "Yes". In this case, any switching times set locally on the device in the configuration menu of the heating timer will be overwritten permanently! Alternatively, the switching times present in the device can be left untouched during an ETS programming operation. To do this, the parameter "Overwrite switching times preset in device during download?" must be set to "no". In this case the switching times defined in the ETS have no function. We recommend that at least during initial commissioning of the push button sensor you define switching times in the ETS and load them in the device.

Use switching time 1? **Yes**
 No

Before the push button sensor is commissioned, switching times can be defined using the ETS. It is possible to edit the up to 28 switching times individually. In the ETS, a switching time is divided into 5 parameters. In order to use a switching time, the parameter "Use switching time X?" must be parameterised to "Yes" (default for switching time 1). In this case it is possible to use further parameters directly to set the time (in hours [0...23] and minutes [0...59]), the desired day of the week for execution and the required controller operating mode. Under day of the week you have the option of selecting individual days ("Monday", "Tuesday", ..., "Saturday", "Sunday"), selecting only workdays (Monday - Friday), selecting the weekend (Saturday - Sunday), or selecting the entire week (Monday - Sunday). Under controller operating mode you can set the modes "Comfort mode", "Standby

		mode", "Night mode" or "Frost/heat protection mode".
Switching time 1 Time in hours [h]	0...23	Sets the time in hours.
Switching time 1 Time in minutes [min]	0...59	Sets the time in minutes.
Switching time 1 Weekday	Monday Tuesday Wednesday Thursday Friday Saturday Sunday Monday - Friday Saturday - Sunday Monday - Sunday	Sets the day of the week for the switching time.
Switching time 1 operating mode	Comfort mode Standby mode Night operation Frost/heat protection mode	Sets the operating mode for the switching time.
Use switching time 2?	Yes No	For configuration of switching times 2...28 see switching time 1!

4.2.5.4 Parameter on scene function

Description	Values	Comment
<p>☐ Scene</p> <p>Scene function ?</p>	<p>Yes</p> <p>No</p>	<p>The device can internally handle eight scenes with eight actuator groups. This parameter activates the scene function and the other parameters and communication objects, if needed.</p>
<p>Overwrite scene values during ETS download?</p>	<p>Yes</p> <p>No</p>	<p>If the values of the actuator groups that have been changed on site by the used are to be reset to the values preset in the ETS during an application download by the ETS, the setting "Yes" must be chosen. If "No" is selected, the ETS values will not overwrite the scene values stored in the push button sensor, if any.</p>
<p>Scene 1 Recall via extension object with scene number</p>	<p>1... 64</p>	<p>If the internal scenes are to be recalled via the extension object, a definite number is required for each of them. This parameter serves to specify the extension number of the first scene.</p>
<p>Scene 2 Recall via extension object with scene number</p>	<p>1...2... 64</p>	<p>If the internal scenes are to be recalled via the extension object, a definite number is required for each of them. This parameter serves to specify the extension number of the second scene.</p>
<p>Scene 3 Recall via extension object with scene number</p>	<p>1...3... 64</p>	<p>If the internal scenes are to be recalled via the extension object, a definite number is required for each of them. This parameter serves to specify the extension number of the third scene.</p>
<p>Scene 4 Recall via extension object with scene number</p>	<p>1...4... 64</p>	<p>If the internal scenes are to be recalled via the extension object, a definite number is required for each of them. This parameter serves to specify the extension number of the fourth scene.</p>
<p>Scene 5 Recall via extension object with scene number</p>	<p>1...5... 64</p>	<p>If the internal scenes are to be recalled via the extension object, a definite number is required for each of them. This parameter serves to specify the extension number of the fifth scene.</p>

Scene 6 Recall via extension object with scene number	1... 6 ... 64	If the internal scenes are to be recalled via the extension object, a definite number is required for each of them. This parameter serves to specify the extension number of the sixth scene.
Scene 7 Recall via extension object with scene number	1... 7 ... 64	If the internal scenes are to be recalled via the extension object, a definite number is required for each of them. This parameter serves to specify the extension number of the seventh scene.
Scene 8 Recall via extension object with scene number	1... 8 ... 64	If the internal scenes are to be recalled via the extension object, a definite number is required for each of them. This parameter serves to specify the extension number of the eighth scene.
<p>☐ Scene -> Scene output 1</p>		
Data type	<p>Switching</p> <p>Value (0 ... 255)</p> <p>Value / position of Venetian blind (0 ... 100%)</p>	Selection of the data format of the scene output.
Scene 1 Switching command	<p>ON</p> <p>OFF</p>	The switching command of the first scene can be predefined here. This parameter is only visible if "Data type = Switching".
Scene 1 Value (0 ... 255)	0 ...255	The value of the first scene can be predefined here. This parameter is only visible if "Data type = Value (0...255)".
Scene 1 Value / position of Venetian blind (0 ... 100 %)	0 ...100	The value of the first scene can be predefined here. This parameter is only visible if "Data type = Value / Venetian blind (0...100%)".
Scene 1 Allow save?	<p>Yes</p> <p>No</p>	If the user is to be given the possibility of changing the value of the scene and of storing it while the system is running, this parameter must be set to "Yes".

Scene 1 Allow transmission?	Yes No	If the state of an actuator group is to remain unchanged during the recall of a scene, this parameter can be set to "No". In this case, the push button sensor does not transmit a telegram via the scene output concerned during the recall of the scene. The scene output is deactivated for this scene.
Scene 1 Transmit delay (1 ... 1200 * 100 ms) (0 = deactivated)	0...1200	When the push button sensor sends the telegrams to the various scene outputs, it can insert a presettable waiting time of 2 min. max. before each telegram. The bus load can be reduced by this. In this way, it is possible to have certain illumination switched on only after the shutters are really closed. If no delay is selected ("0" setting), the push button sensor sends the output telegrams with maximum speed. With this setting it may happen in some cases that the telegram sequence is not compatible with output numbering.
Scenes 2 ... 8 see scene 1!		
<input type="checkbox"/> Scene output 2 ... 8 (see Scene output 1)		

4.2.5.5 Parameters for the display

Description	Values	Comment
<p>☐ Display</p> <p>Language</p>	<p>German</p> <p>English</p> <p>Dutch</p> <p>Norwegian</p> <p>Russian</p> <p>Polish</p> <p>Downloaded language</p>	<p>This parameter defines the language used to depict the texts specified by the manufacturer in the display. If the setting "Downloaded language" is selected, a language file has to be programmed into the device using the ETS plug-in To do this, press the "Service Download" button and then select a language file and program it in. If no language is downloaded, the display shows the notice "font error" for a certain time. The push button sensor is then functional and works with English display texts after the error display.</p>
<p>Display format of the temperature values</p>	<p>°C</p> <p>°F</p>	<p>The temperatures can be indicated in the display of the device in °C or alternatively in °F. This display format can be configured in the ETS in common for all temperature values using this parameter. This parameter only affects the display. The temperature values in the communication objects are not affected by this. Here the value transfer always takes place in °C!</p>
<p>Function of the LCD illumination</p>	<p>always OFF</p> <p>always ON</p> <p>Control via object</p> <p>automatic switch-off</p>	<p>This parameter defines the function of the LCD illumination. The LCD illumination can be permanently on or off or alternatively be switched via a communication object. Optionally the LCD illumination can be switched on by pressing any desired button and switched off again automatically after a delay time has elapsed. Here the parameter "Time for automatic switch-off" defines the delay until switch-off after the last button-press. Each button-press re-initiates the delay time.</p>
<p>Control via object value</p>	<p>1 = static ON / 0 = static OFF</p> <p>1 = static OFF / 0 = static ON</p> <p>1 = flashing / 0 = static OFF</p> <p>1 = static OFF /</p>	<p>If the "Function of the LCD illumination" is set to "Control via object", then the telegram polarity of the 1-bit object "B.LCD illumination" can be specified at this point. The illumination can be switched on or off statically. In addition, the received switching telegram can be evaluated in such a way that the illumination flashes.</p>

	0 = LED flashing	
Time for automatic switch-off Minutes (0...20)	0...20	If the "Function of the LCD illumination" is set to "Automatic switch-off", the delay before switch-off after the last button-press can be configured here. Setting the delay time minutes.
Seconds (0...59)	0...3...59	Setting the delay time seconds.
Selection of the display areas	<p>Only one display area (menu area)</p> <p>Two display areas (status line & menu area)</p>	<p>A general distinction can be made between the display structure of the 1-area and 2-area display.</p> <p>When only one display area is used, the normal display shows temperature values and indicates the operating mode of the room temperature controller. This type of display is the clearest and simplest display function, with only a single large menu area.</p> <p>With two display areas, the upper area of the normal display, also called the status line, shows icons that indicate various operating modes of the room temperature controller or the controller extension. Moreover it is optionally possible to display in the status line the time (left justified) and additional temperature values of the controller extension (right-justified). The lower area of the display, also called the menu area, can be used to visualise various temperature values in a single-line or two-line format.</p>
Display in the status line	<p>Time</p> <p>Room temperature</p> <p>Outdoor temperature</p> <p>Setpoint temperature</p> <p>Time / room temperature</p> <p>Time / outdoor temperature</p> <p>Time / setpoint temperature</p>	<p>This parameter defines the display function of the status line. The time is always displayed left-justified within the status line. The temperature values available for selection are always displayed right-justified. In addition to the display functions that can be selected, the push button sensor shows in the central part of the status line information in the form of icons regarding the room temperature controller or the controller extension, the status of the push button sensor disable function, or the state of the heating timer. If no temperature values are to be displayed in the status line (only indication of the time), then the icons are displayed right-justified in place of the temperature.</p> <p>This parameter is only visible with "Selection of the display areas = two"</p>

		display areas"!
Displayed in the menu area	<p>Room temperature</p> <p>Outdoor temperature</p> <p>Setpoint temperature</p> <p>Room- / outdoor temperature</p> <p>Room- / setpoint temperature</p> <p>Outside / setpoint temperature</p> <p>Value display</p> <p>Setpoint shift as bar graph only text display</p>	<p>This parameter defines the display function of the menu area in the 2-area display. Generally the selected temperature values are displayed left-justified in the menu area. With selection of combined temperature values, value display or "only text display", the display appears in the menu area in a two-line format using a smaller character set. This parameter is only visible in this form with "Selection of the display areas = two display areas"!</p>
Displayed in the menu area	<p>Room temperature</p> <p>Outdoor temperature</p> <p>Setpoint temperature</p>	<p>This parameter defines the display function of the menu area in the 1-area display. Generally the selected temperature values are displayed left-justified in the menu area with a large character set. This parameter is only visible in this form with "Selection of the display areas = one display area"!</p>
Object type of the value display line 1 / line 2	<p>DPT 5.xxx, 6.xxx, 1 byte</p> <p>DPT 7.xxx, 8.xxx, 9.xxx, 2 byte</p> <p>DPT 12.xxx, 13.xxx, 14.xxx, 4 byte</p> <p>DPT 16.xxx, 14-byte ASCII text</p> <p>DPT 10.001, 3-byte time</p> <p>DPT 11.001, 3-byte date</p>	<p>As an alternative to displaying temperature values with fixed formatting, the display of practically any desired 1-byte, 2-byte or 4-byte values that are forwarded to the push button sensor by the KNX/EIB via separate communication objects can be displayed in various data formats and representation formats. Thus, for example, it is possible to display dimming or brightness values of a lighting system (feedback from a dimmer actuator or a constant light regulation), to depict room temperatures from other building areas, to signal the height of blinds incl. slat angle (feedback from a shutter actuator), or also to display ASCII texts up to 14 characters long for other bus devices (e.g. facility management, alarm system).</p> <p>Displaying of values in the menu area of the display is used if the display function is parameterised to "Value display". In this case the values are always</p>

		displayed in two lines (the same parameterisation options for line 1 and line 2). It is thus possible to evaluate and depict up to two values independently of each other using separate communication objects. The "Object type of the value display" parameter determines the display and formatting options within a line, and also the data format of the value object.
Format of the value display line 1 / line 2	<p>without sign</p> <p>with sign</p>	For the object type "DPT 5.xxx, 6.xxx, 1 byte" the value can be displayed either without a sign (object value range: 0...255) or with a sign (object value range: -128...127). This parameter defines the display format for the 1-byte value display.
Format of the value display line 1 / line 2	<p>Integer</p> <p>Floating-point number</p>	For the object types "DPT 7.xxx, 8.xxx, 9.xxx, 2 byte" and "DPT 12.xxx, 13.xxx, 14.xxx, 4 byte" the value can be displayed either as a whole number or as a floating-point number. This parameter defines the display format for the 2-byte and 4-byte value display.
Depiction of the value display Line 1 / line 2	<p>0...255</p> <p>0...100 %</p> <p>0...360 °</p>	This parameter defines the representation of the received values. It is only visible in the 1-byte display format without a sign. The units "%" or "°" are shown in the display immediately after the value.
Number of positions after the decimal point line 1 / line 2	<p>none</p> <p>one</p> <p>two</p>	In the display format "floating-point number", this parameter defines the number of positions after the decimal point for 2-byte or 4-byte value display.
Display of a supplementary text line 1 / line 2	<p>Yes</p> <p>No</p>	Display functions in one or two-line format can be expanded using supplementary texts. In this manner it is possible to describe the display values in greater detail, e.g. by adding a unit. The supplementary texts are always shown in the display to the immediate right of the display function (temperature value, value). Without a display function ("only text display") the supplementary text is shown left-justified in the display. This parameter is not visible with "Display in the menu area = Setpoint shift as bar graph"!

<p>Supplementary text line 1 / line 2</p>	<p>Text, free text with up to 30 characters</p>	<p>The supplementary text is parameterised here. The supplementary texts can be up to 30 characters. Each time a button is pressed, the ETS plug-in checks the pixel character spacing of the letter that has been entered, and if necessary limits the text being entered to the length that can be displayed. This parameter is only visible with "Display of a supplementary text... = Yes"!</p>
<p>Confirm the setpoint in the display using OK?</p>	<p>Yes No</p>	<p>This parameter defines how a locally set setpoint shift is applied. In the "Yes" setting, an OK command is required for valid application of the setpoint shift. Pressing both display buttons simultaneously triggers the OK command. The controller then applies the setpoint shift immediately. The display then returns to the normal display. In the "No" setting, the controller applies the set setpoint shift automatically, each time the display buttons are pressed (+ or -). The display returns to the normal display when any button of the rockers 1...n is pressed or no entry is made via the display buttons for 15 seconds. This parameter is only available in the application version 1.2.</p>
<p>Fault message texts via bus</p>	<p>Deactivated activated</p>	<p>It is possible to display up to two fault messages on the display of the push button sensor. To activate the fault message display, set this parameter to "activated". The two communication objects "Fault message text 1" and "Fault message text 2" are then available for displaying the fault messages. If the push button sensor receives a telegram via one of these objects, the ASCII text contained in the telegram is shown on the display directly. Based on the data point type, the fault message texts can be up to 14 characters long.</p>
<p>Display length of the fault message texts Minutes (1...255)</p>	<p>1...255</p>	<p>The fault message remains visible in the display until the display length configured in the ETS (1...255 minutes) has elapsed. Each telegram to one of the two fault message objects re-</p>

		<p>initiates the display length. Fault message texts visible on the display can be overwritten at any time with new text telegrams. This parameter is only visible when "Fault message texts via bus = activated"!</p>
Alarm texts via bus	<p>Deactivated</p> <p>activated with acknowledgement object</p> <p>activated without acknowledgement object</p>	<p>It is possible to display up to two alarm signals on the display of the push button sensor. To activate the alarm message display, set this parameter to "activated...". einzustellen. The two communication objects "Alarm text 1" and "Alarm text 2" are then available for displaying the alarm texts. If the push button sensor receives a telegram via one of these objects, the ASCII text contained in the telegram is shown on the display directly. Based on the data point type, the alarm texts can be up to 14 characters long.</p> <p>Alarm signals remain in the display until the display is acknowledged actively. Acknowledgement in this manner is possible by pressing both display buttons of the device at the same time. An acknowledgement that has been made can optionally be transmitted to the bus via a separate 1-bit communication object and thus forwarded to other bus devices (e.g. visualisations). In this case the parameter "Alarm texts via bus = activated with acknowledgement object" must be configured. Then the "Alarm text acknowledge" transmits an acknowledgement telegram to the bus immediately after a successful acknowledgment. If the parameter "Alarm texts via bus" is configured to "activated without acknowledgement object", then no bus acknowledgement is performed. The alarm is merely confirmed locally on the device.</p>
Polarity of the object for alarm acknowledgement	<p>not inverted (Acknowledge = 1)</p> <p>inverted (Acknowledge = 0)</p>	<p>This parameter sets the telegram polarity of the "Alarm text acknowledge" object. It is only visible when "Alarm texts via bus = activated with acknowledgement object"!</p>
Manual fan control and fan level in the display	<p>enabled</p> <p>Disabled</p>	<p>The manual fan control makes it possible to control the fan of a fan coil, independent of the command value specification of a room temperature</p>

		<p>controller. With the push button sensor 3 plus, manual control of the fan is possible via a rocker switch or push button function and also via the configuration menu. Independently of the fan control, the current fan level of a fan coil and its heating/cooling mode can be shown on the display of the push button sensor.</p> <p>The manual fan control and the fan level display are configured centrally here. The function must be enabled globally ("Enabled" setting) so that manual fan control is possible via the device rockers or buttons and via the configuration menu. The fan levels can also only be shown in the display of the push button sensor after global enable has been made.</p> <p>It is not possible to show the fan levels on the display if only one display area is configured.</p>
Fan level display object type	6 x 1 bit 1 x 1 byte	<p>To show the current fan level in the display, and also for manual fan control (using a 1-byte value), the push button sensor requires the information as to which fan level is active in the actuator. In addition, the fan coil actuator must transmit a fan level feedback telegram to the push button sensor.</p> <p>Configuration of the data format for the fan level feedback is performed using the parameter "Fan level display object type" parameter. The receiving object of the fan level feedback in the push button sensor must be set to the same data format as the actuator!</p>
Fan level change-over in case of manual specification via	Value object (1 byte) Switching direction object (1 bit)	<p>The parameter "Fan level change-over in case of manual specification via" defines in the fan coil actuator whether the fan levels are switched over manually using a 1-bit object (switching direction presetting) or alternatively using a 1-byte object (value presetting). The push button sensor 3 plus supports both methods for manual control. The push button sensor and actuator must be configured to the same data format!</p>
Push button assistance function	Deactivated activated	<p>If desired, you can activate a push button assistance text for the function keys of the push button sensor in the ETS. The purpose of the pushbutton assistance function is to indicate to the</p>

operator what function will be executed when a key is actuated (e.g. "Dining light ON", "Blind DOWN", "Temperature comfort"). This help text display function can be activated centrally using this parameter. The push button assistance text parameters for the function buttons and rocker switches are only visible in the ETS after central enabling.

Display length of the
push button assistance
function
Seconds (1...59) 1...**3**...59

This parameter defines the display length for the push button assistance function after a button is pressed. This push button assistance text will be shown on the display of the pushbuttons sensor immediately as soon as a rocker switch or button is pressed. At the same time the rocker switch or push button functions parameterised in the ETS will be executed, i.e. telegrams will be transmitted to the bus, for example, or the internal controller will be operated.

5 Appendix

5.1 Index

Numerical

2-point feedback control..... 119,125

A

Accept setpoints permanently..... 147

Adapting.....123,125

Alarm texts..... 190

automatic frost protection..... 134

B

Basic setpoint shift..... 147,172

brightness..... 106

button function..... 82

C

Clipping..... 161

Colour setting.....104

Comfort extension.....133

Command value limit..... 159

Command value objects..... 155

commissioning..... 14,37

communication objects..... 38

Configuring heating timer.....26

control algorithm..... 115

control surfaces..... 15

controller extension.....166

Controller status.....157

D

Device combination..... 37

Device components..... 9

dew point mode..... 162

Dimensions..... 9

Dimming.....85

display contrast.....30

Display control surface..... 15

Display functions.....182

display priorities..... 186-187

Display structure..... 181

E

ETS14,37

ETS search paths..... 32

F

Fan controller.....22

Fault message texts.....190

Full-surface operation..... 81

H

heating timer..... 163

Heating/cooling message..... 113

I

inscription panels.....9

L

Labelling field illumination.....79

M

Main menu..... 20

manual fan control..... 192

measured value formation..... 152

mixed operating mode..... 112

O

Operating areas..... 80

operating mode after a reset..... 135

Operating mode switchover..... 23,127

operating modes..... 111

P

PI control.....116,123

Presence button.....172

Presence function..... 133

product database..... 37

R

rocker function..... 80

Room temperature measurement..... 176

S

Scene control.....178

Scene definition..... 178

Scene extension..... 93

scene recall.....178

setpoint shift..... 18

Setpoint temperature presetting..... 136

Setpoint temperature setting.....24

Setpoint temperatures..... 138

single operating modes.....111

status LEDs..... 100

Storing scenes..... 179

superposed function..... 104
Switching..... 84
Switching PI control..... 117

T

Temperature detection.....152
Transmission delay.....79

V

value transmitter..... 91
Valve protection..... 165
Venetian blind.....87

W

window status..... 134

Gira
Giersiepen GmbH & Co. KG
Elektro-Installations-
Systeme

Industriegebiet Mermbach
Dahlienstraße
42477 Radevormwald

Postfach 12 20
42461 Radevormwald

Deutschland

Tel +49(0)21 95 - 602-0
Fax +49(0)21 95 - 602-191

www.gira.de
info@gira.de