



Dimming actuator, 1-gang

Order no.: 2171 00

Dimming actuator, 2-gang

Order no.: 2172 00

Dimming actuator, 4-gang

Order no.: 2174 00

Operating instructions

1 Safety instructions



Electrical devices may only be mounted and connected by electrically skilled persons.

Serious injuries, fire or property damage possible. Please read and follow manual fully.

Danger of electric shock. Always disconnect before carrying out work on the device or load.

Danger of electric shock. Device is not suitable for disconnection from supply voltage. The load is not electrically isolated from the mains even when the output is switched off.

Risk of destruction of the dimmer and load if the set operating mode and load type do not match. Set the correct dimming principle before connecting or exchanging the load.

Fire hazard. For operation with inductive transformers, each transformer must be fused on the primary side in accordance with the manufacturer's instructions. Only safety transformers according to EN 61558-2-6 may be used.

These instructions are an integral part of the product, and must remain with the end customer.

i The connected load and dimmer quality on LED lamps are dependent on the type of lamp and installation conditions. The connected load of the specified values could vary. We cannot assume any guarantee for proper function, dimming results and dimming quality.

2 Device components

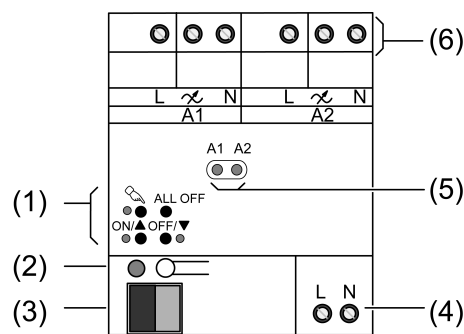

Figure 1: View of dimming actuator 2-gang

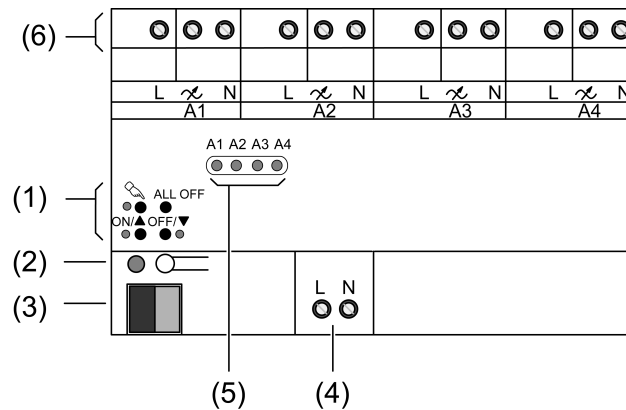

Figure 2: View of dimming actuator 4-gang

- (1) Button field for manual operation
- (2) Programming button and LEDs
- (3) KNX connection
- (4) Mains connection (optional, if operation should be possible without bus voltage)
- (5) Status LED
- (6) Terminal outputs

3 Function

System information

This device is a product of the KNX system and complies with the KNX directives. Detailed technical knowledge obtained in KNX training courses is a prerequisite to proper understanding.

The function of this device depends upon the software. Detailed information on loadable software and attainable functionality as well as the software itself can be obtained from the manufacturer's product database. Planning, installation and commissioning of the device are carried out with the aid of KNX-certified software. The latest versions of product database and the technical descriptions are available on our website.

Intended use

From device version **V04** (see imprint) and application program.

- Switching and dimming of
 - incandescent lamps,
 - HV halogen lamps,
 - dimnable HV-LED lamps,
 - dimnable compact fluorescent lamps,
 - dimnable inductive transformers with LV halogen or LV LED lamps,
 - dimnable electronic transformers with LV halogen or LV LED lamps
- Mounting on DIN rail according to EN 60715 in sub-distribution unit

- i** If inductive or electronic transformers are connected, observe the data of the transformer manufacturer on loads and the dimming principle.
- i** HV-LED and compact fluorescent lamps generate high pulsed currents, when they are operated in the leading edge phase control.
- i** Our dimmers take into account the different electronic characteristics of most LED lamps found on the market. However, it cannot be guaranteed that in individual cases the desired results may not be achieved.

Only dimming actuator 1-gang:

- Speed controller for regulating the speed of single-phase motors e.g. induction motors, shaded pole motors or universal motors

Product characteristics

- Automatic or manual selection of the dimming principle suitable for the load
- Protected against no-load, short-circuit and overheating
- Signal in the event of a short-circuit
- Outputs can be operated manually
- Feedback of the switching position and the dimming value
- Parameterisable switch-on and dimming behaviour
- Time functions: switch-on delay, switch-off delay, staircase lighting timer with run-on time
- Light scene operation
- Disabling of individual outputs manually or by bus
- Status indicator of the outputs via LED
- Operating hours counter
- Mains failure longer than approx. 5 seconds leads to switch-off of the dimming actuator. Depending on the parameter setting, the connected load is calibrated after resumption of power supply.
- Power extension possible by means of power boosters.

i Delivery state: Construction site mode, outputs can be operated using button field.
 Delivery state of the dimming actuator 1-gang: Dimming operation.

i Flickering of the connected lamps due to undershoot of the specified minimum load or through centralised pulses from the power stations. This does not represent any defect in the device.

Only dimming actuator 4-gang:

- Increase in output power possible through parallel switching of multiple outputs

4 Operation

Operating elements

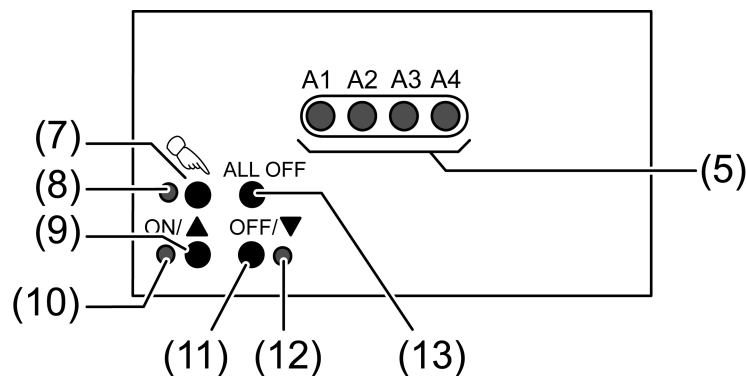

Figure 3: Operating elements

- (5) Status LEDs for outputs
- (7) Button – Manual operation
- (8) LED – on: continuous manual mode
- (9) Button ON/▲: Switch on/increase brightness
- (10) LED ON/▲ – on: Selected output on, 1...100%
- (11) Button OFF/▼: Switch off/reduce brightness
- (12) LED OFF/▼ – on: Selected output off
- (13) ALL OFF Button: Switching off all outputs

Status indication

The status LED A1... (5) indicate the states of the outputs.

- Off: Output switched off
- On: Output switched on
- Flashes slowly: Output in manual mode
- Flashes quickly: Output disabled via continuous manual mode



Operating modes

- Bus operation: Operation via push-button sensors or other bus devices
- Short-term manual operation: Manual operation locally with button field, automatic return to bus operation.
- Continuous manual mode: Exclusively manual operation on the device

- i** No bus operation is possible in manual mode.
- i** No manual mode is possible in case of bus failure.
- i** After a bus failure and restoration the device switches to bus operation.
- i** After a power failure and restoration the device switches to bus operation.
- i** The manual mode can be disabled in ongoing operation via a bus telegram.

Switching on the temporary manual control

Operation using the button field is programmed and not disabled.

- Press the  button briefly.
LED A1 flashes, LED  remains off.
- i** After 5 seconds without a button actuation, the actuator returns automatically to bus operation.



Switching off temporary manual operation

The device is in short-term manual mode.

- No button-press for 5 seconds.
- or -
- Press  button briefly as many time as necessary until the actuator leaves the short-time manual mode.
LEDs A1... no longer flash, but rather indicate the output status.



Switching on permanent manual control

Operation using the button field is programmed and not disabled.

- Press the  button for at least 5 seconds.
LED  is illuminated, status LED A1 flashes, continuous manual mode is switched on.

Switching off permanent manual control

The device is in continuous manual mode.

- Press the  button for at least 5 seconds.
LED  is off, bus operation is switched on.

Operating the outputs

The device is in continuous or short-term manual mode.

- Press the  button briefly as many times as necessary until the desired output is selected.
The LED of the selected output A1... flashes.
The LEDs ON/▲ and OFF/▼ indicate the status.

- Operate the output with the button **ON/▲** or the button **OFF/▼**.
Short: switch on/off.
Long: dim brighter/darker.
Release: Stop dimming.
The LEDs **ON/▲** and **OFF/▼** indicate the status.
- i** Short-term manual operation: After running through all of the outputs the device exits manual mode after another brief press.

Switching off all outputs

The device is in continuous manual mode.

- Press the **ALL OFF** button.
All outputs are shut off.

Disabling individual outputs

The device is in continuous manual mode.

- Press the  button briefly as many times as necessary until the desired output is selected.
The status LED of the selected output **A1...** flashes.
- Press the buttons **ON/▲** and **OFF/▼** simultaneously for at least 5 seconds.
Selected output is disabled.
The status LED of the selected output **A1...** flashes quickly.
- Activate bus mode (see section Deactivating permanent manual control).
- i** A disabled output can be operated in manual mode.
- i** When a disabled output is selected in manual mode, the corresponding status LED flashes twice briefly at intervals.

Re-enabling outputs

The device is in continuous manual mode.

- Press the  button briefly as many times as necessary until the desired output is selected.
The status LED of the selected output **A1...** flashes twice briefly at time intervals.
- Press the buttons **ON/▲** and **OFF/▼** simultaneously for at least 5 seconds.
Selected output is enabled.
LED of the selected output flashes slowly.
- Activate bus mode (see section Deactivating permanent manual control).

5 Information for electrically skilled persons

5.1 Fitting and electrical connection



DANGER!

Mortal danger of electric shock.

Disconnect the device. Cover up live parts.

Fitting the device

Observe the temperature range. Ensure adequate cooling. Maintain a distance of 18 mm, 1 module when operating multiple dimmers or power units within the same control cabinet.

- Mount device on DIN rail. Output terminals must be at the top.

Connecting lamp load

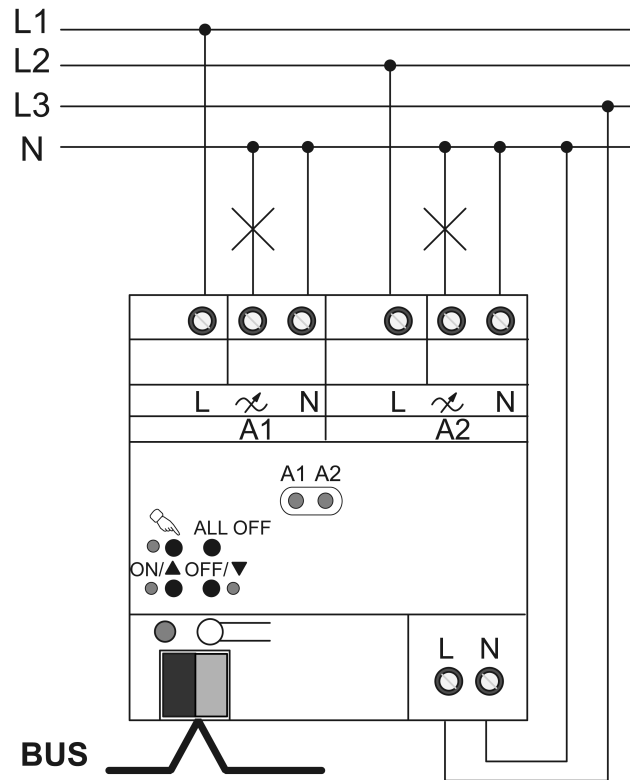

Figure 4: Dimming actuator – Connection example

Do not exceed permissible total load including transformer power dissipation.

Operate inductive transformers with at least 85% nominal load.

Mixed loads with inductive transformers: ohmic load max. 50%.

HV-LED lamps and compact fluorescent lamps: Only connect lamps of one manufacturer and of the same type on the same output. Do not connect any other loads to this output.

- i** Connect 600 W HV LED lamps or compact fluorescent lamps at most per 16 A circuit breaker.
- i** The dimming principle in the as-delivered state: "Universal". If setting the dimming principle manually, ensure that the dimming principle and the connected load match. Observe the information in the Technical Documentation.
- i** Use the settings "HV-LED trailing edge phase control" and "HV-LED leading edge phase control" only for HV-LED lamps or compact fluorescent lamps.

The mains connection (4) is required for construction site operation - manual operation without a connected bus voltage.



CAUTION!

Danger of destruction from mixed loads.

The dimmer and load may be destroyed.

Do not connect capacitive loads, e.g. electronic transformers, and inductive loads, e.g. inductive transformers, together on the same dimmer output.

Do not connect inductive transformers together with HV LED lamps or compact fluorescent lamps on the same dimmer output.

- Connect device as shown in the connection example (Figure 4).

- i** Choose power boosters that are suitable for the dimmer and load. Program the operation with Universal power extensions in the device or – with devices up to version V01 – set the maximum brightness to 90 %. For more information please see instructions of the respective power pack.

Changing connected load type

When changing the connected load, e. g. replacement of a connected luminaire. The dimming actuator only calibrates itself again after disconnection of the mains voltage and load.



CAUTION!

Risk of destruction if the preset dimming principle and connected load do not match. The dimmer and load may be destroyed.

Before changing the dimming principle, observe load type.

Before changing the load type, make sure that the dimming principle is correct.

- Disconnect load circuit.
- Disconnect mains voltage.
- Connect changed load.
- Program dimming actuator to the new load type.

Connecting lamp load up to 950 W

Only possible with dimming actuator 4-gang: Several dimmer outputs can be combined for dimming greater loads.

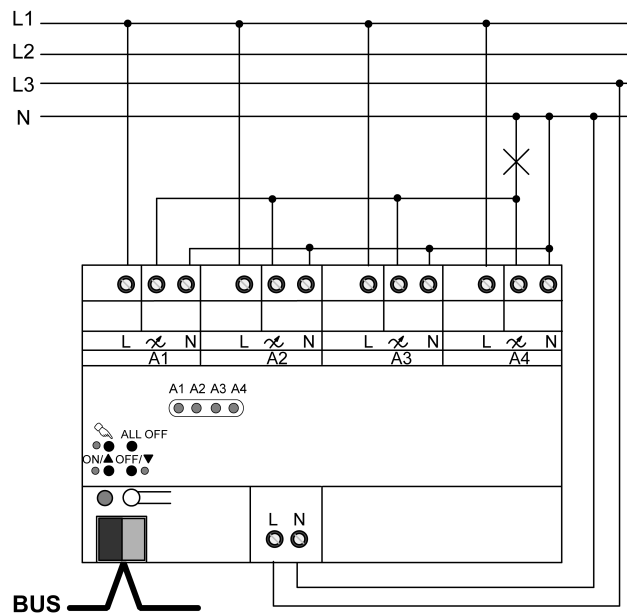

Figure 5: Parallel switching of dimmer outputs – connection example

Do not connect any LED lamps or compact fluorescent lamps to dimmer outputs switched in parallel.

Only utilize parallel-switched outputs up to 95 % each.

- i** Observe delivery state. Before connecting and switching on, program the dimming actuator to the changed output configuration.



CAUTION!

Danger of destruction. 400 V are shorted when outputs switched in parallel are connected to different outer phase conductors.

The device will be destroyed.

Always connect outputs switched in parallel to the same outer phase conductor.

- Connect device as shown in the connection example (Figure 5).
- i** Do not expand parallel-switched dimmer outputs with power packs.

Connecting the motors

Only possible with dimming actuator 1-gang: Usage as speed controller for electrical motors.

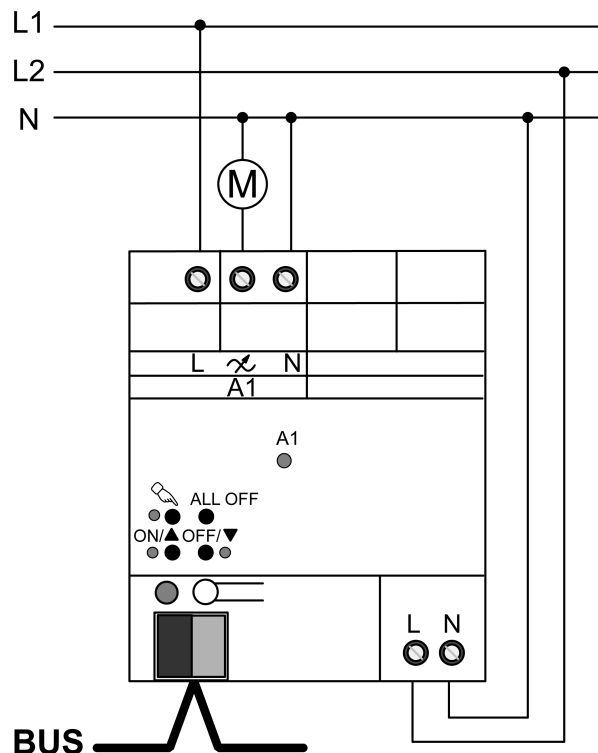

Figure 6: Dimming actuator 1-gang – connection for speed controller operation

Observe delivery state. Before connecting and switching on, program the dimming actuator for operation as speed controller.

- Connect device as shown in the connection example (Figure 6).
- i** During the commissioning, the minimum speed of the connected motor must be determined and the actuator adapted to this.

Installing the cover

It is necessary to install a cover to protect the bus connection against hazardous voltages in the connection area.

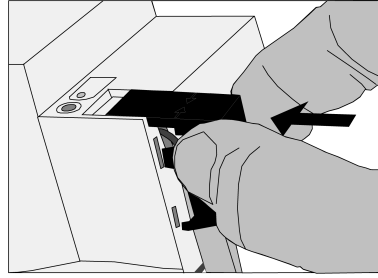

Figure 7: Installing the cover

- Route the bus line towards the rear.
- Install cover on top of the bus terminal so that it snaps into place (Figure 7).

Removing the cover

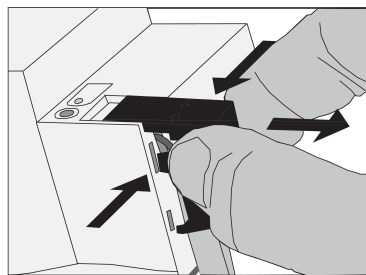

Figure 8: Removing the cover

- Press the cover to the side and pull it off (Figure 8).

5.2 Commissioning

Loading the physical address and application software



CAUTION!

Risk of destruction if the preset dimming principle and connected load do not match.
Dimming actuator and load may be destroyed.

Before commissioning, make sure that the software setting matches the load.

- Switch on the bus voltage.
 - Press the programming button.
 - Load the physical address into the device.
 - Load the application software.
 - Switch on voltage supply on the outputs.
 - Switch mains voltage on.
- The device calibrates itself to the load and selects the appropriate dimming procedure leading edge or trailing edge phase control.
- i** The calibration procedure becomes noticeable during ohmic loads by a brief flicker and lasts between 1 to 10 seconds depending on the network conditions.
 - i** During the calibration phase, received operations are executed after completion of the calibration procedure.
 - i** The dimming procedure can also be predefined with the parameterization. In this case, the calibration procedure is not necessary.

Using speed controllers: Setting minimum speed

Only for dimming actuator 1gang.

When deployed as a speed controller, the device must be adapted to the minimum speed of the connected motor.



CAUTION!

Connected motors must not stop.

Risk of destruction for motor and controlling device.

Set the minimum speed in such a way that the motor does not stop at a minimum setting.

The physical address and application software are loaded into the device. The device is programmed as a speed controller.

- Load the connected motor with the maximum load that occurs during operation.
 - Switch on dimming actuator.
The dimming actuator switches on the connected motor to the cutting-in speed.
After the set resting time has elapsed, the dimming actuator sets the currently required speed.
 - Slowly reduce the speed setting, e. g. with manual control, until the connected motor has reached its minimum permitted speed. While doing so, take the motor follow-up into account.
 - Determine the current setting, e. g. by reading the current value of the communication object "Feedback of speed".
 - Enter the determined value as minimum speed in the parameter settings.
 - Load changed application software into the device.
- i** The set cutting-in speed must remain active until the connected motor has started and has reached the cutting-in speed. Adapt and load the resting time into the device if necessary.
- i** The technical documentation contains detailed information on this.

6 Appendix

6.1 Technical data

Dimming actuator, 1-gang, order no. 2171 00

Rated voltage	AC 110 ... 230 V ~
Mains frequency	50 / 60 Hz
Power loss	max. 4 W
Standby power	max. 0.5 W
Ambient temperature	-5 ... +45 °C
Storage/transport temperature	-25 ... +70 °C
Switching current motors	2.3 A
Power consumption 230 V per output	
Incandescent lamps	20 ... 500 W
HV halogen lamps	20 ... 500 W
HV-LED lamps	typ. 3 ... 100 W
Compact fl lamp.	typ. 3 ... 100 W
Inductive transformers	20 ... 500 VA
Inductive transformers with LV-LED	20 ... 100 VA
Electronic transformers	20 ... 500 W

Electronic transformers with LV-LED 20 ... 100 W

i Inductive capacitive mixed load is not permitted.

i With setting "LED trailing edge phase control" the connection power for HV-LED lamps and electronic transformers with LV-LED doubles.

Power consumption 110 V per output

Incandescent lamps 20 ... 250 W

HV halogen lamps 20 ... 250 W

HV-LED lamps typ. 3 ... 50 W

Compact fl lamp. typ. 3 ... 50 W

Inductive transformers 20 ... 250 VA

Inductive transformers with LV-LED 20 ... 50 VA

Electronic transformers 20 ... 250 W

Electronic transformers with LV-LED 20 ... 50 W

i Inductive capacitive mixed load is not permitted.

i With setting "LED trailing edge phase control" the connection power for HV-LED lamps and electronic transformers with LV-LED doubles.

Power boosters

See power booster instructions

Connection

single stranded 0.5 ... 4 mm²

Finely stranded without conductor sleeve 0.5 ... 4 mm²

Finely stranded with conductor sleeve 0.5 ... 2.5 mm²

Fitting width 72 mm / 4 module

KNX

KNX medium TP256

Commissioning mode S-mode

Rated voltage KNX DC 21 ... 32 V SELV

Current consumption KNX 15 mA

Connection mode KNX device connection terminal

Dimming actuator, 2-gang, order no. 2172 00

Rated voltage AC 110 ... 230 V ~

Mains frequency 50 / 60 Hz

Power loss max. 4 W

Standby power max. 0.8 W

Ambient temperature -5 ... +45 °C

Storage/transport temperature -25 ... +70 °C

Power consumption 230 V per output

Incandescent lamps 20 ... 300 W

HV halogen lamps 20 ... 300 W

HV-LED lamps typ. 3 ... 60 W

Compact fl lamp. typ. 3 ... 60 W

Inductive transformers 20 ... 300 VA

Inductive transformers with LV-LED 20 ... 100 VA

Electronic transformers 20 ... 300 W

Electronic transformers with LV-LED 20 ... 100 W

- i** Inductive capacitive mixed load is not permitted.
- i** With setting "LED trailing edge phase control" the connection power for HV-LED lamps and electronic transformers with LV-LED doubles.

Total power consumption

at 230 V max. 600 W/VA

- i** In the case of unbalanced load, an output may be loaded with a max of 350 W/VA (230 V) as long as the permissible total power consumption is not exceeded.

Power consumption 110 V per output

Incandescent lamps	20 ... 150 W
HV halogen lamps	20 ... 150 W
HV-LED lamps	typ. 3 ... 30 W
Compact fl lamp.	typ. 3 ... 30 W
Inductive transformers	20 ... 150 VA
Inductive transformers with LV-LED	20 ... 50 VA
Electronic transformers	20 ... 150 W
Electronic transformers with LV-LED	20 ... 50 W

- i** Inductive capacitive mixed load is not permitted.
- i** With setting "LED trailing edge phase control" the connection power for HV-LED lamps and electronic transformers with LV-LED doubles.

Total power consumption

at 110 V max. 300 W/VA

- i** In the case of unbalanced load, an output may be loaded with a max of 175 W/VA (110 V) as long as the permissible total power consumption is not exceeded.

Power boosters See power booster instructions

Connection

single stranded	0.5 ... 4 mm ²
Finely stranded without conductor sleeve	0.5 ... 4 mm ²
Finely stranded with conductor sleeve	0.5 ... 2.5 mm ²
Fitting width	72 mm / 4 module

KNX

KNX medium	TP256
Commissioning mode	S-mode
Rated voltage KNX	DC 21 ... 32 V SELV
Current consumption KNX	15 mA
Connection mode KNX	device connection terminal

Dimming actuator, 4-gang, order no. 2174 00

Rated voltage	AC 110 ... 230 V ~
Mains frequency	50 / 60 Hz
Power loss	max. 8 W
Standby power	max. 1.4 W
Ambient temperature	-5 ... +45 °C
Storage/transport temperature	-25 ... +70 °C

Power consumption 230 V per output

Incandescent lamps	20 ... 250 W
HV halogen lamps	20 ... 250 W
HV-LED lamps	typ. 3 ... 50 W
Compact fl lamp.	typ. 3 ... 50 W
Inductive transformers	20 ... 250 VA
Inductive transformers with LV-LED	20 ... 100 VA
Inductive transformers	20 ... 250 VA
Electronic transformers with LV-LED	20 ... 100 W

i Inductive capacitive mixed load is not permitted.

i With setting "LED trailing edge phase control" the connection power for HV-LED lamps and electronic transformers with LV-LED doubles.

Power consumption 110 V per output

Incandescent lamps	20 ... 120 W
Incandescent lamps	20 ... 120 W
HV halogen lamps	20 ... 120 W
HV-LED lamps	typ. 3 ... 24 W
Compact fl lamp.	typ. 3 ... 24 W
Inductive transformers with LV-LED	20 ... 50 VA
Electronic transformers	20 ... 120 W
Electronic transformers with LV-LED	20 ... 50 W

i Inductive capacitive mixed load is not permitted.

i With setting "LED trailing edge phase control" the connection power for HV-LED lamps and electronic transformers with LV-LED doubles.

Power boosters

See power booster instructions

Connection

single stranded	0.5 ... 4 mm ²
Finely stranded without conductor sleeve	0.5 ... 4 mm ²
Finely stranded with conductor sleeve	0.5 ... 2.5 mm ²
Fitting width	144 mm / 8 module

KNX

KNX medium	TP256
Commissioning mode	S-mode
Rated voltage KNX	DC 21 ... 32 V SELV
Current consumption KNX	15 mA
Connection mode KNX	device connection terminal

6.2 Troubleshooting

Connected LED lamps or compact fluorescent lamps switch off in the lowest dimming position or flicker

The set minimum brightness is too low.
Increase minimum brightness.

Connected LED lamps or compact fluorescent lamps flicker

Cause 1: Lamps are not dimmable.

Check manufacturer's instructions.

Exchange lamps for another type.

Cause 2: Dimming principle and lamps do not optimally match.

For HV-LED: Check operation in another dimming principle, reduce connected load as well if necessary.

For LV-LED: Check the lamp operating device and replace as necessary.

With the "Universal" setting: Define the dimming principle manually.

Connected HV-LED lamps or compact fluorescent lamps in the lowest dimming position are too bright; dimming range is too small

Cause 1: The set minimum brightness is too high.

Reduce minimum brightness.

Cause 2: HV-LED trailing edge phase control dimming principle does not optimally match the connected lamps.

Check operation in the "HV-LED leading edge phase control" setting, reduce connected load as well if necessary.

Exchange lamps for another type.

Output has switched off.

Cause 1: overheating protection has tripped.

Disconnect mains supply and all outputs from the mains, switch-off corresponding circuit breakers.

HV-LED trailing edge phase control: Reduce the connected load. Exchange lamps for another type.

HV-LED leading edge phase control: Reduce the connected load. Check the operation in the "HV-LED trailing edge phase control" setting. Exchange lamps for another type.

Let device cool down for at least 15 minutes. Check installation situation, ensure cooling, e.g. provide distance from surrounding devices.

Cause 2: Surge protection has triggered.

HV-LED trailing edge phase control: Check the operation in the "HV-LED leading edge phase control" setting, reduce the connected load as well if necessary.

Exchange lamps for another type.

i The response of the surge protection can be signalled by sending a short-circuit telegram or can be determined by polling the "short-circuit" communication object.

Cause 3: short-circuit in output circuit

Disconnect mains voltage and affected output from the mains supply.

Eliminate short-circuit.

First switch on the output voltage again and then the mains supply. Switch the affected output off and on again.

i When a short-circuit occurs the affected output switches off. Automatic restart when short-circuit is eliminated within 100 ms (inductive load) or 7 seconds (capacitive or ohmic load). After that lasting switch-off.

i When a short-circuit occurs during the calibration process, the load calibrates itself again after the short-circuit is eliminated.

Cause 4: load failure.

Check load, replace light bulb. For inductive transformers, check primary fuse and replace if necessary.

Manual control with button field not possible

Cause 1: Manual control has not been programmed.

Program manual control.

Cause 2: Manual control via bus disabled.

Enable manual control.

Output cannot be operated.

Cause 1: Manual control has not been programmed.

Reprogram device.

Cause 2: Manual control via bus disabled.

Enable manual control.

None of the outputs can be operated.

Cause 1: All of the outputs are disabled-

Cancel disabling.

Cause 2: Manual mode active.

Deactivate manual mode (switch off continuous manual mode).

Cause 3: Application software missing or faulty.

Check programming and correct.

Cause 4: Application software has been stopped, programming LED is flashing.

Disconnect device from the bus and mains, switch on again after 10 seconds.

All outputs off and not possible to switch on

Cause 1: bus voltage failure.

Check bus voltage.

Cause 2: mains voltage failure.

Check mains voltage on outputs and mains power supply.

Luminaires flicker or buzz, proper dimming not possible, device buzzes

Cause: wrong dimming principle set

Installation or commissioning error. Disconnect device and luminaire, switch off circuit breaker.

Check installation and correct.

If the wrong dimming principle has been preselected: Set correct dimming principle.

If dimming actuator calibrates itself incorrectly, e.g. with highly inductive mains or long load cables: preselect correct dimming principle with commissioning.

LED lamp is dimly lit when dimmer is switched off

Cause: LED lamp is not optimally suited for this dimmer.

Use a compensation module, see accessories.

Use another type of LED lamp or an LED lamp of another manufacturer.

Light switches on at maximum brightness and then dims to the target value.

Cause: Device is programmed as a speed controller.

Reprogram device.

When using as a speed controller: Motor does not start

Cause: Device is programmed as a dimmer.

Switch off device immediately.

Reprogram device.

When using as a speed controller: Motor stops at low speed

Cause: Set base speed is too low.

Commissioning error. Switch off device.

Reprogram device. Readjust base speed (see chapter 5.2. Commissioning).

6.3 Accessories

Compensation module LED

Order no. 2375 00

6.4 Warranty

The warranty is provided in accordance with statutory requirements via the specialist trade. Please submit or send faulty devices postage paid together with an error description to your responsible salesperson (specialist trade/installation company/electrical specialist trade). They will forward the devices to the Gira Service Center.

Gira
Giersiepen GmbH & Co. KG
Elektro-Installations-
Systeme

Industriegebiet Mermbach
Dahlienstraße
42477 Radevormwald

Postfach 12 20
42461 Radevormwald

Deutschland

Tel +49(0)21 95 - 602-0
Fax +49(0)21 95 - 602-191

www.gira.de
info@gira.de