

Fan Coil actuator
Order-No. : 2163 00



Operating instructions

1 Safety instructions

Electrical equipment may only be installed and fitted by electrically skilled persons.

Failure to observe the instructions may cause damage to the device and result in fire and other hazards.

Danger of electric shock. Always disconnect before carrying out work on the device or load. At the same time, take into account all circuit breakers that supply dangerous voltage to the device or load.

Danger of electric shock. Device is not suitable for disconnection from supply voltage.

Danger of electric shock on the SELV/PELV installation. Not suitable for switching SELV/PELV voltages.

Do not connect any three-phase motors. Device can be damaged.

These instructions are an integral part of the product, and must remain with the end customer.

2 Device components

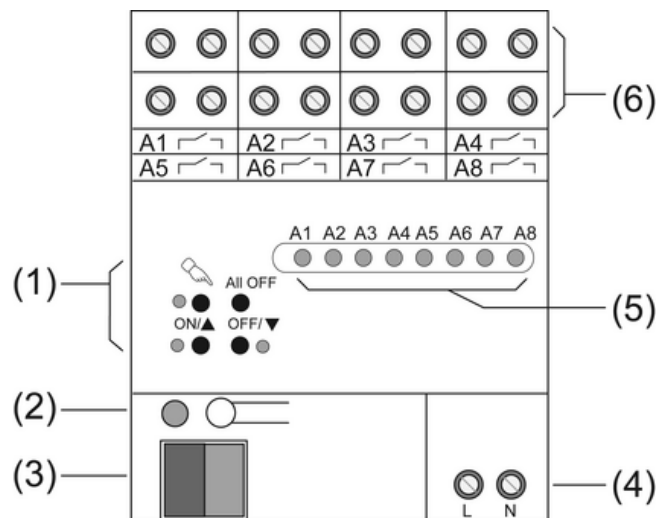

Figure 1: Device components front view

- (1) Button field for manual control
- (2) Programming button and LEDs
- (3) KNX connection
- (4) Connection for mains supply
- (5) Status LEDs for outputs
- (6) Connection of fan coil unit

3 Function

System information

This device is a product of the KNX system and complies with the KNX directives. Detailed technical knowledge obtained in KNX training courses is a prerequisite to proper understanding.

The function of this device depends upon the software. Detailed information on loadable software and attainable functionality as well as the software itself can be obtained from the manufacturer's product database.

Planning, installation and commissioning of the device are carried out with the aid of KNX-certified software. Full functionality with KNX commissioning software version ETS3.0d onwards.

An updated version of the product database, technical descriptions and conversion programs and other auxiliary programs are available on our Internet website.

Intended use

- Switching of electrical fan coil units
- Switching of electrical loads AC 230 V, e.g. fans
- Installation in distribution boxes on DIN rail according to EN 60715

Product characteristics

- Connection of one fan coil unit with up to 6 fan levels or connection of two fan coil units with up to 3 fan levels each
- Outputs can be operated manually, construction site mode
- Operating modes for heating, cooling or combined heating/cooling operation
- 2-pipe or 4-pipe operation
- Individual or hierarchical switching of fan levels
- Feedback
- Output indication
- Disabling function for each channel

4 Operation

Operating elements

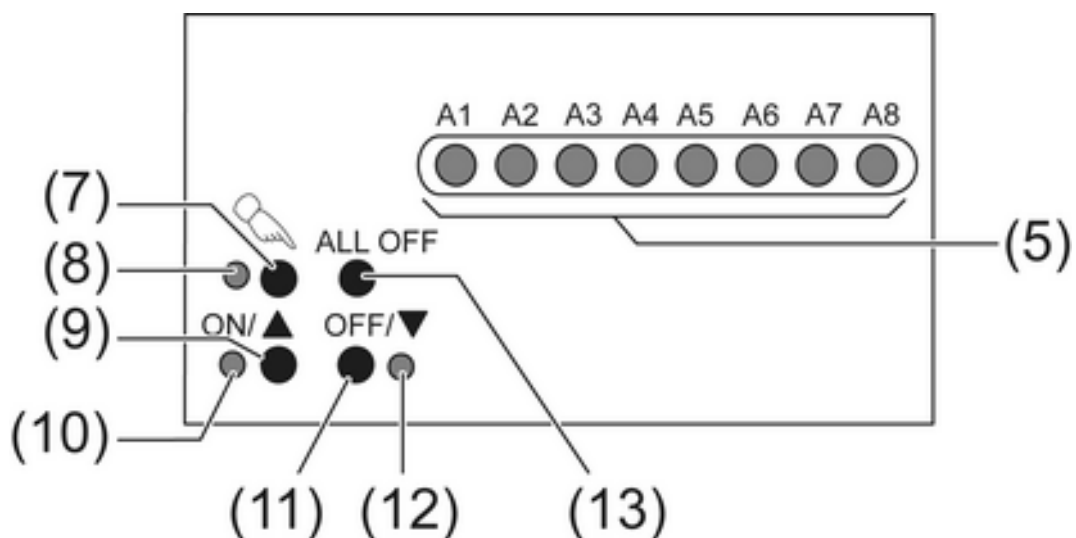

Figure 2: Operating elements – Overview

- (5) Status LEDs for outputs
- (7) Button – Manual control
- (8) LED – On: Continuous manual mode active
- (9) Button **ON/▲** – Switch on

- (10) LED **ON/▲** – Switched on, Manual operation
- (11) Button **OFF/▼** – Switch off
- (12) LED **OFF/▼** – Switched off, Manual operation
- (13) Button **ALL OFF** – All outputs off

Status indication

The status LEDs A1...A8 (5) indicate the states of the outputs.



- Off: Output switched off
- On: Output switched on
- Flashes slowly: Output in manual mode
- Flashes quickly: Output disabled via continuous manual mode

Operating modes

- Bus operation: Operation via push-button sensors or other bus devices
 - Short-term manual operation: Manual operation locally with button field, automatic return to bus operation.
 - Continuous manual mode: Exclusively manual operation on the device
- i** No bus operation is possible in manual mode.
 - i** No manual mode is possible in case of bus failure.
 - i** After a bus failure and restoration the device switches to bus operation.
 - i** After a power failure and restoration the device switches to bus operation.
 - i** The manual mode can be disabled in ongoing operation via a bus telegram.

Switching on the temporary manual control

Operation using the button field is programmed and not disabled.

- Press the  button briefly.
LED **A1** flashes, LED  remains off.
- i** After 5 seconds without a button-press, the actuator returns automatically to bus operation.

Deactivating temporary manual control

The device is in short-term manual mode.

- No button-press for 5 seconds.
- or -
- Press  button briefly as many time as necessary until the actuator leaves the short-time manual mode.

Status LEDs **A1...A8** no longer flash, but rather indicate the output status.



Heating/cooling outputs: When switching off the manual control, the outputs, depending on the programming, switch to the active position, e.g. forced position.

Fan outputs: When switching off the manual control, the outputs, depending on the programming, switch to the active position, e.g. forced position.

Switching outputs: When the manual operation is switched off, the output relays remain in the current position.



Switching on permanent manual control

Operation using the button field is programmed and not disabled.

- Press the  button for at least 5 seconds.
LED  is illuminated, status LED **A1** flashes, continuous manual mode is switched on.

Deactivating permanent manual control

The device is in continuous manual mode.

- Press the  button for at least 5 seconds.
LED  is off, bus operation is switched on.

Heating/cooling outputs: When switching off the manual control, the outputs, depending on the programming, switch to the active position, e.g. forced position.

Fan outputs: When switching off the manual control, the outputs, depending on the programming, switch to the active position, e.g. forced position.

Switching outputs: When the manual operation is switched off, the output relays remain in the current position.

Operating the outputs

In manual operation the relay outputs can be operated instantly. Depending on programming, the switching of an output also influences additional outputs.

The device is in continuous or short-term manual mode.

- Press  button briefly, < 1 s, as many times as necessary until the desired output is selected.





The LED of the selected output **A1...A8** flashes.

The LEDs **ON/▲** and **OFF/▼** indicate the status.

- Operate output with **ON/▲** or **OFF/▼** button.
Heating/cooling outputs: Open or close valve.
Fan outputs: Set fan level.
Switching outputs: Switch on or switch off.

The selected output switches on or off.

The LEDs **ON/▲** and **OFF/▼** indicate the status.

-  Depending on programming and the selected output, several outputs switch simultaneously.
-  Heating and cooling of a fan-coil output are never switched on simultaneously.
-  At least the first fan level is active with the heating or cooling output.
-  Short-term manual operation: After running through all of the outputs the device exits manual mode after another brief press.

Switching off all outputs



The device is in continuous manual mode.

- Press the **ALL OFF** button.
All outputs are shut off.

Disabling individual outputs

The device is in continuous manual mode.

- Press  button briefly as many times as necessary until the desired output is selected.
The status LED of the selected output **A1...** flashes.
- Press **ON/▲** and **OFF/▼** buttons simultaneously for at least 5 seconds.
Selected output is disabled.
The status LED of the selected output **A1...** flashes quickly.
- Activate bus mode (see section Deactivating permanent manual control).

-  A disabled output can be operated in permanent manual mode.
-  If a disabled output is selected in manual control, the LEDs flash twice briefly with a time interval.

Re-enabling outputs

The device is in continuous manual mode.

- Press  button briefly as many times as necessary until the desired output is selected.
The status LED of the selected output **A1...A8** flashes twice briefly at time intervals.
- Press **ON/▲** and **OFF/▼** buttons simultaneously for at least 5 seconds.
Selected output is enabled.
LED of the selected output flashes slowly.
- Activate bus mode (see section Deactivating permanent manual control).

5 Information for electrically skilled persons

5.1 Fitting and electrical connection



DANGER!

Electrical shock when live parts are touched.

Electrical shocks can be fatal.

Before carrying out work on the device or load, disengage all the corresponding circuit breakers. Cover up live parts in the working environment.

Fitting the device

Observe the temperature range. Ensure sufficient cooling.

- Mount the device on DIN rail. Output terminals must be at the top.

Connecting the device

Note permitted loads.

- i** The assignment of the outputs depends on the configured operating mode (see table 1, 2 and 3).

Operating mode 1	2-pipe	only heating	
Operating mode 2	2-pipe	only cooling	
Operating mode 3	2-pipe	Heating/cooling	switch-over object
Operating mode 4	4-pipe	Heating/cooling	switch-over object
Operating mode 5	4-pipe	Heating/cooling	Setpoint command value

Table 1: Operating modes

- i** Outputs not used for controlling fan levels can be used for simple switching. Please see configuration data for the assignment of output terminals.
 - Connect bus cable with connecting terminal (Figure 3).
 - Connect the mains power supply.
 - Connect fan-coil-units to the outputs of the actuator in accordance with configuration.
 - If multiple miniature circuit breakers supply dangerous voltages to the device or load, couple the miniature circuit breakers or label them with a warning, to ensure release is guaranteed.
- i** A fan-coil output with up to six fan levels: see connection example (Figure 3). Information regarding assignment of the outputs in (table 2), (Figure 4) and (Figure 5).
- i** Two fan-coil outputs with up to three fan levels each: see connection example (Figure 6). Information regarding assignment of the outputs in (table 3), (Figure 7) and (Figure 8).
- i** Please refer to the documentation of these devices for more details on connecting fan-coil devices.

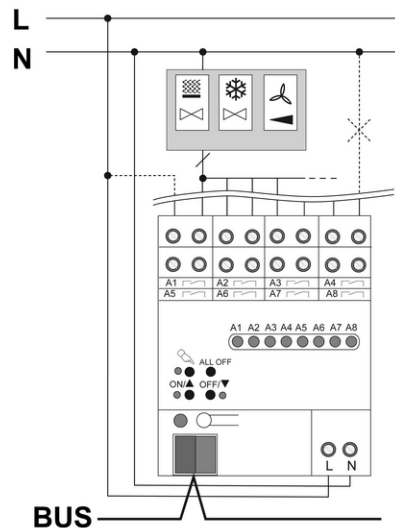

Figure 3: Connection example – load connection for 1 fan-coil output

Operating mode	A1	A2	A3...A8
1	Heating valve	-	Fan levels
2	Cooling valve	-	Fan levels
3	Heating/cooling valve	-	Fan levels
4	Cooling valve	Heating valve	Fan levels
5	Cooling valve	Heating valve	Fan levels

Table 2: Output assignment 1 fan-coil output



		A3	A4	A5	A6	A7	A8
 	1	1	0	0	0	0	0
	2	1	1	0	0	0	0
	3	1	1	1	0	0	0
	4	1	1	1	1	0	0
	5	1	1	1	1	1	0
	6	1	1	1	1	1	1

Figure 4: Single-channel fan levels for hierarchical switching – powered outputs



		A3	A4	A5	A6	A7	A8
 	1	1	0	0	0	0	0
	2	0	1	0	0	0	0
	3	0	0	1	0	0	0
	4	0	0	0	1	0	0
	5	0	0	0	0	1	0
	6	0	0	0	0	0	1

Figure 5: Single-channel fan levels for individual switching – powered outputs

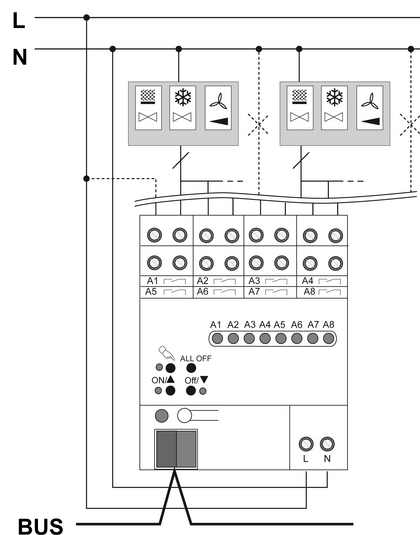

Figure 6: Connection example – load connection for 2 fan-coil outputs

Operating mode	A1 / A5	A2-4 / A6-8
1	Heating valve	Fan levels
2	Cooling valve	Fan levels
3	Heating/cooling valve	Fan levels

Table 3: Output assignment 2 fan-coil outputs



		A2	A3	A4	A6	A7	A8
	1	1	0	0	1	0	0
	2	1	1	0	1	1	0
	3	1	1	1	1	1	1

Figure 7: Two-channel fan levels for hierarchical switching – powered outputs



		A2	A3	A4	A6	A7	A8
	1	1	0	0	1	0	0
	2	0	1	0	0	1	0
	3	0	0	1	0	0	1

Figure 8: Two-channel fan levels for individual switching – powered outputs

Installing the cover

It is necessary to install a cover to protect the bus connection against hazardous voltages in the connection area.

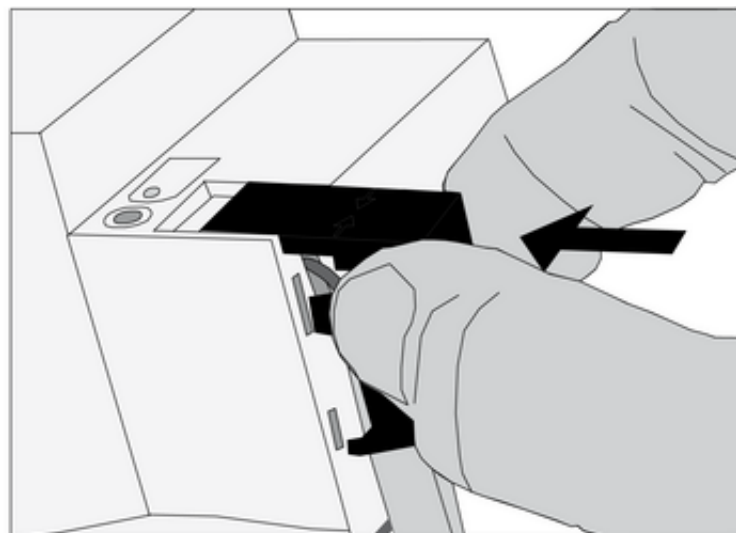

Figure 9: Installing the cover

- Route the bus cable towards the rear.
- Install cover on top of the bus terminal so that it snaps into place (Figure 9).

Removing the cover

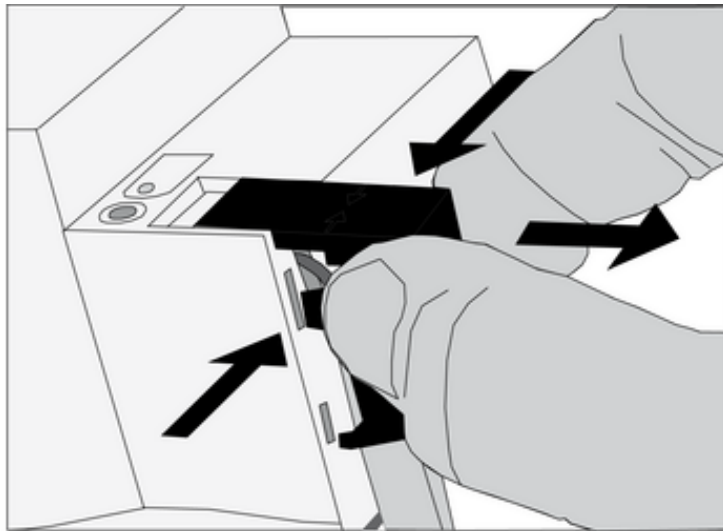

Figure 10: Removing the cover

- Press the cover to the side and pull it off (Figure 10).

5.2 Commissioning

Load the address and the application software

- Switch on the bus voltage
- Assign physical address.
- Load the application software into the device.
- Note the physical address on the device label.

6 Appendix

6.1 Technical data

Supply	
Rated voltage	AC 230 / 240 V ~
Mains frequency	50 / 60 Hz
Power loss	max. 3 W
Ambient conditions	
Ambient temperature	-5 ... +45 °C
Storage/transport temperature	-25 ... +70 °C
Outputs	
Contact type	μ contact, potential-free NO contact
Switching voltage	AC 250 V ~
Switching current AC1	10 A
Switching current AC3	10 A
Loads per output	
Ohmic load	2300 W
Capacitive load 10 A	max. 140 μF
Motors	1380 VA
Switch-on current 200 μs	max. 800 A
Switch-on current 20 ms	max. 165 A
Lamp loads	
Incandescent lamps	2300 W
HV halogen lamps	2300 W
LV halogen lamps with Tronic transformer	1500 W
LV halogen lamps with inductive transformer	1200 VA

Fluorescent lamps T5/T8 uncompensated	1000 W
parallel compensated	1160 W (140 µF)
Duo circuit	2300 W (140 µF)
Compact fluorescent lamps uncompensated	1000 W
parallel compensated	1160 W (140 µF)
Mercury vapour lamps uncompensated	1000 W
parallel compensated	1160 W (140 µF)
Connections supply and load	
Connection mode	Screw terminal
Single stranded	0.5 ... 4 mm ²
finely stranded without conductor sleeve	0.5 ... 4 mm ²
finely stranded with conductor sleeve	0.5 ... 2.5 mm ²
Fitting width	72 mm / 4 modules
Weight	approx. 290 g
KNX	
KNX medium	TP 1
Commissioning mode	S-mode
Rated voltage KNX	DC 21 ... 32 V SELV
Power consumption KNX	typical 150 mW
Connection type for bus	Connection terminal

6.2 Troubleshooting

Manual control with button field not possible

Cause 1: Manual control has not been programmed.

Program manual control.

Cause 2: Manual control via bus disabled.

Enable manual control.

Cause 3: No mains voltage.

Switch on mains voltage. Check fuse

Output cannot be operated.

Cause: Output is disabled.

Cancel disabling.

None of the outputs can be operated.

Cause 1: All of the outputs are disabled-

Cancel disabling.

Cause 2: Continuous manual mode is active.

Deactivate manual mode (see chapter "Switch off continuous manual mode").

Cause 3: Application software has been stopped, programming LED is flashing.

Perform reset: Disconnect device from bus, switch on again after 5 seconds.

Operation via bus is not possible

Cause 1: No bus voltage.

Switch on bus voltage, have installation checked by electrician.

Cause 2: Application software has been stopped, programming LED is flashing.

Perform reset: Disconnect device from bus, switch on again after 5 seconds.

Cause 3: No application software or faulty application software loaded.

Check programming and correct.

6.3 Warranty

The warranty is provided in accordance with statutory requirements via the specialist trade. Please submit or send faulty devices postage paid together with an error description to your responsible salesperson (specialist trade/installation company/electrical specialist trade). They will forward the devices to the Gira Service Center.

Gira
Giersiepen GmbH & Co. KG
Elektro-Installations-
Systeme

Industriegebiet Mermbach
Dahlienstraße
42477 Radevormwald

Postfach 12 20
42461 Radevormwald

Deutschland

Tel +49(0)21 95 - 602-0
Fax +49(0)21 95 - 602-399

www.gira.de
info@gira.de