

Weather station Standard

Order No. 2150 04

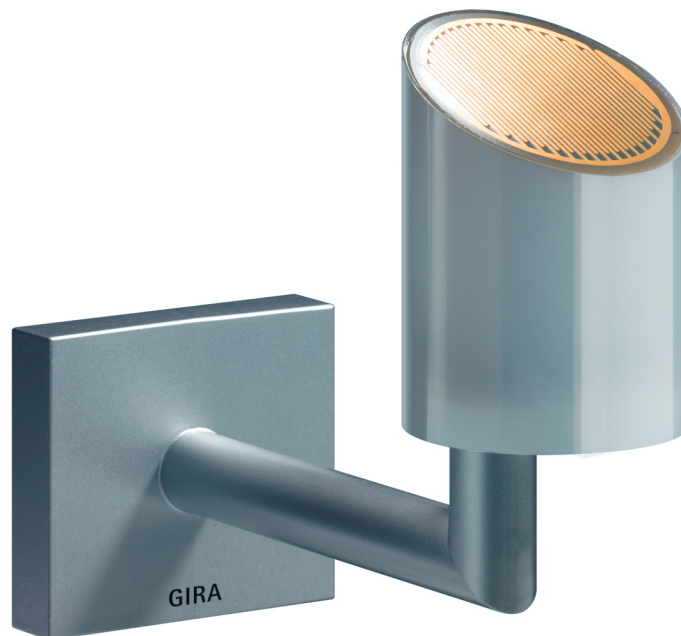

Table of Contents

1	Product definition	3
1.1	Product catalog	3
1.2	Purpose	3
1.3	Accessories	4
2	Mounting, electrical connection and operation	5
2.1	Safety instructions	5
2.2	Structure of the device	6
2.3	Mounting and electrical connection	7
2.4	Commissioning	11
3	Technical data	12
4	Software description	13
4.1	Software specification	13
4.2	Software B009x1	14
4.2.1	Scope of functions	14
4.2.2	Notes on software	15
4.2.3	Data points	16
4.2.4	Functional description	25
4.2.4.1	Application-oriented functional description	25
4.2.4.2	Sensor function	31
4.2.4.3	Logic operations and blocking elements	40
4.2.4.4	Condition as shipped	43
4.2.5	Parameter	44
5	Appendix	78
5.1	Index	78

1 Product definition

1.1 Product catalog

Product name: Weather station standard

Use: Physical sensor

Design: Surface-mounted device for outdoor installation

1.2 Purpose

Function

The KNX weather station detects the meteorological data "Wind speed", "Precipitation", "Twilight", "Temperature", and three directions of brightness.

- i** The measured values apply to the mounting location. Variations to other weather services – e.g. through local turbulence or areas with build-ups of air – are possible.

The main area of application is automatic, weather-independent control of shading. It is specially designed for use in homes. To increase function safety, the weather station monitors some key functions itself and automatically signals appropriate errors to the bus using signal objects.

It is intended for external mounting on a mast or on the wall.

There is an integrated bus coupling unit to the KNX/EIB (Monoblock).

Evaluation of the data, in particular limiting value processing, takes place in the weather station.

An integrated heater provides protection against function restriction due to frost or dew down to -20 °C. In addition, the heater protects the sensor surface of the precipitation sensor by providing quick drying after rain and thawing in case of snow and ice.

The power supply to the unit is via the bus, except for the heater and the precipitation sensor power supply. The weather station requires a 24 V AC/DC power supply for the heater, without which precipitation detection is not possible.

Logic gates are available in order to cascade multiple weather stations or to gate the limiting values and the monitoring functions.

Disabling elements make it possible to block individual functions in situ.

1.3 Accessories

Power supply

Order No. 1024 00

Additional power supply

Order No. 2570 00

Mast attachment for installation on free-standing masts

Order No. 0848 00

2 Mounting, electrical connection and operation

2.1 Safety instructions

Electrical equipment may only be installed and fitted by electrically skilled persons. The applicable accident prevention regulations must be observed.

Make sure during the installation that there is always sufficient insulation between the mains voltage and the bus. A minimum distance of at least 4 mm must be maintained between bus conductors and mains voltage cores.

Before working on the device or exchanging the connected loads, disconnect it from the power supply (switch off the miniature circuit breaker), otherwise there is the risk of an electric shock.

The device may not be opened or operated outside the technical specifications.

Failure to observe the instructions may cause damage to the device and result in fire and other hazards.

2.2 Structure of the device

Device components

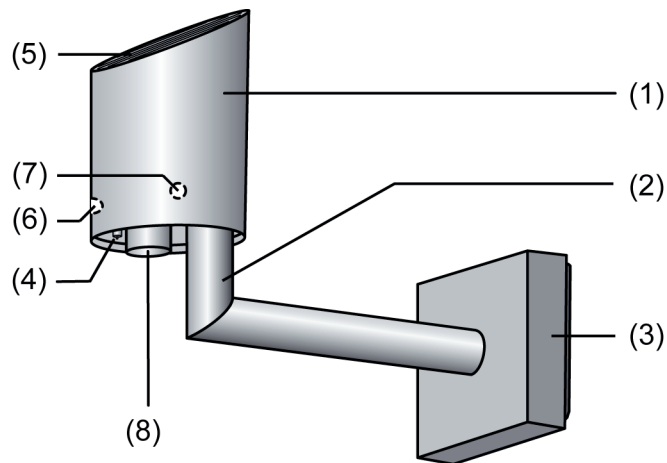

Figure 1: Structure of the weather station

- (1) Translucent sensor head with the sensor surface of the precipitation sensor, the temperature sensor, the twilight sensor, the wind sensor and the 3 brightness sensors
- (2) Angular arm with variable latching for orienting the sensor head
- (3) Terminal box for connecting the KNX/EIB and the heating voltage to the sensor head
- (4) Location of the temperature sensor
- (5) Sensor surface of the precipitation sensor
- (6) Location of the twilight sensor and brightness sensor 2
- (7) Location of brightness sensor 1 (brightness sensor 3 is located in the 9 o'clock position (Figure 6) and is thus not visible in this view)
- (8) Location of the thermal wind sensor

Approx. dimensions height 170 mm, depth 204 mm, width 88 mm

i The supplied magnet is used to program the sensor.

2.3 Mounting and electrical connection

Selecting the installation location

- Select a mounting location in which the weather station is not influenced by local obstacles or shading, such as surrounding trees, chimneys, awnings, etc. The sensor must be able to detect wind, rain and ambient brightness without impedance.
- ❗ Do not mount it below or next to building sections, from which water can drip onto the device.
- ❗ Select the mounting location so that the weather station will be accessible for maintenance purposes.
- ❗ In the case of flat roofs, locate the weather station as close to the centre of the roof as possible.
- ❗ Minimum distance to surface beneath the weather station: 0.6 m. Otherwise, the sensors on the underside may get damaged by penetrating spray water.

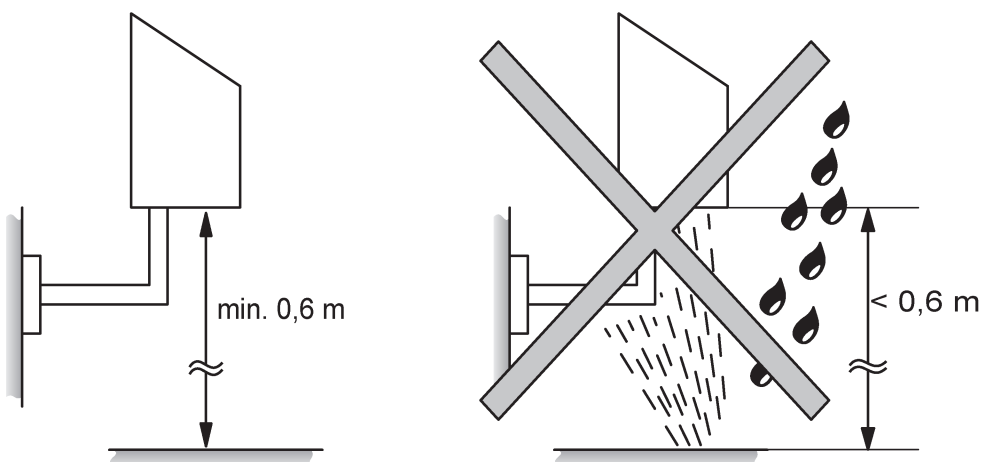

Figure 2: Minimum distance to surfaces

- ❗ Direct sunlight, chimneys or other waste gas or ventilation systems affect the temperature measurement.
- ❗ Do not operate in the vicinity of radio transmitter systems. Doing so will compromise function.
- ❗ Installation on tubular mast with separate mast fastening (see accessories).

Mounting and connecting the device



DANGER!

Electrical shock when live parts are touched.

Electrical shocks can be fatal.

Before working on the device, disconnect the power supply and cover up live parts in the working environment.

- Remove the lower part (9) of the terminal box (3).

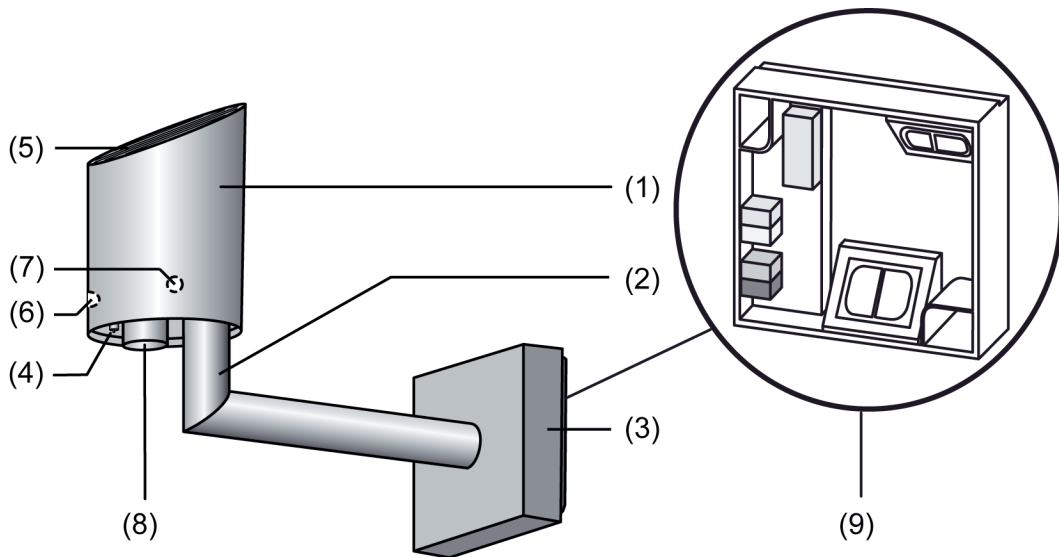

Figure 3: Weather station with terminal box

- Route the cables for the power supply and bus connection through one of the two cable entries (15) and into the terminal box (9).

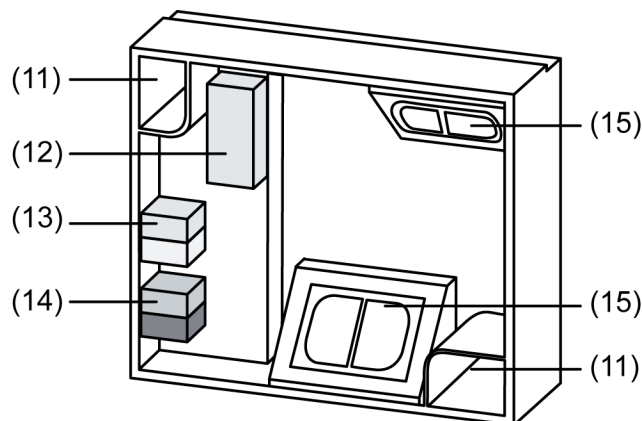

Figure 4: Lower part of terminal box (9)

- Stick screws through the holes (11) in the lower part of the terminal box (9) and fasten to wall of house, mast tube, etc.
- Connect supply voltage to connecting terminal (13).
- Connect KNX bus line to connecting terminal (14).
- Connect plug connector of the sensor to connecting terminal (12).



CAUTION!

The angular arm (2) may break when the terminal box is opened.

The device can be damaged!

The angular arm must not be used as a lever and pulled downwards.

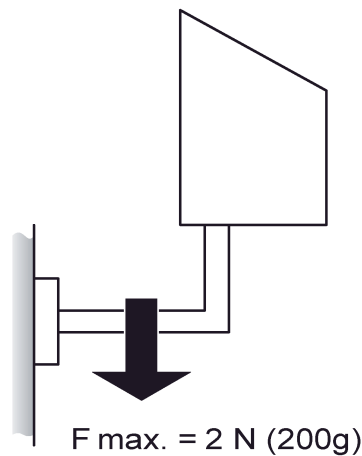

Figure 5: Maximum load on the angular arm of the weather station

- Set upper part of the terminal box (3) with the sensor (1, 2) from above onto the lower part of the terminal box (9) and engage it below.
- ⓘ The sensor head (1) is translucent to enable brightness and twilight measurements. Therefore do not stick anything to or write on the sensor head (1), as doing so will lead to measurement errors.

Orienting the weather station

The brightness sensors of the weather station can be oriented either in the compass directions (east, south, west), or for rectangular buildings (especially with conservatories) according to three sides of the building.

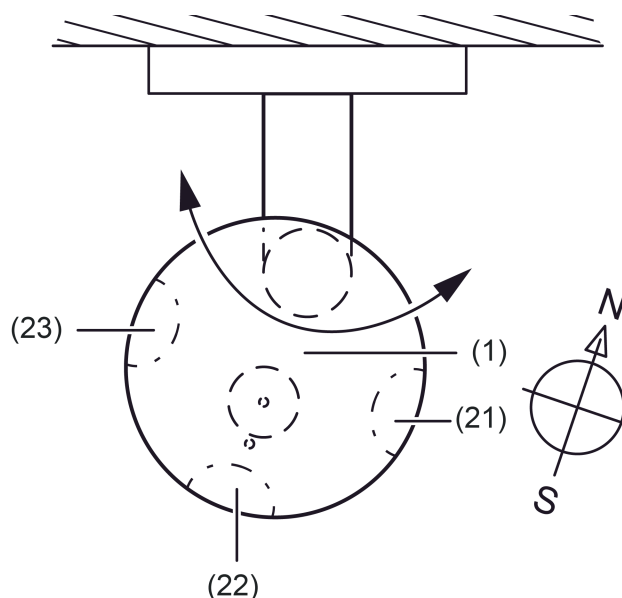

Figure 6: Orientation of the weather station

- (1) Sensor head
- (21) Brightness sensor 1

(22) Brightness sensor 2

(23) Brightness sensor 3

Orientation in the compass directions:

- Using a compass, align the sensor head using a compass in such a way that the bevelled side of the housing (sensor surface of the binary precipitation sensor) and the brightness sensor 2 (22) point south.
- ⓘ Without correct orientation the brightness sensors will not be assigned to the compass directions east (21), south (22) and west (23).
- ⓘ Select this orientation if 4 or more sides of the building are to be shaded.
- ⓘ Select this orientation if a side faces approximately to the south.

Orientation according to the sides of the building (for example a three-sided conservatory):

- Orient the inclined side of the housing (sensor surface of the precipitation sensor) parallel to the centre-most of the three sides of the building to be shaded.

2.4 Commissioning

Commissioning the device



DANGER!

Electrical shock when live parts are touched.

Electrical shocks can be fatal.

Before working on the device, disconnect the power supply and cover up live parts in the working environment.

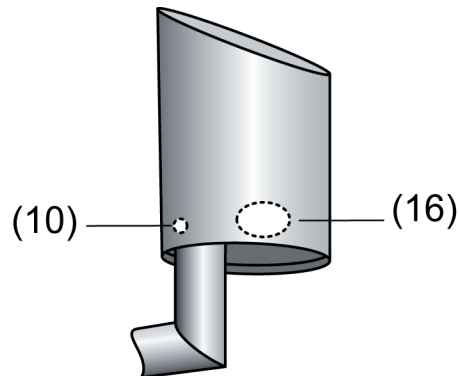

Figure 7: Operating elements

(10) Position of the programming LED

(16) Position of the reed contact

- Switch on bus voltage.
- Switch on supply voltage.
- Hold the supplied programming magnet by the integrated reed contact (16).
The programming LED (10) shows the programming state red.

- i** The programming LED shines through the translucent housing of the sensor head, and is not visible when not lit up.
- Assign physical addresses and load application software into the device.
The programming LED (10) goes out.

3 Technical data

KNX

KNX medium	TP1
Commissioning mode	S-mode
Voltage (KNX/EIB)	21 ... 32 V DC SELV
Power consumption KNX	typ. 450 mW
KNX/EIB connection	Bus connecting terminal

Power supply, external

Rated voltage	24 V AC/DC SELV
Power consumption	typ. 7.5 W
Connection mode	Connecting terminal yellow/white

Environment

Storage/transport temperature	-40 ... +70 °C
-------------------------------	----------------

Form

Housing type	Surface-mounted with terminal box
Degree of protection	IP 44 (in position for use)

Sensor signals

Wind

Measuring range for wind	0 ... 40 m/s
Accuracy	2 m/s

Precipitation

Measuring range for precipitation	Yes/No (binary)
-----------------------------------	-----------------

Brightness (3 sensors, each offset 90°)

Measuring range for brightness	1 ... 110 klx
Spectral range	700 ... 1050 nm
Accuracy	10 % (fm. ET)

Twilight

Measuring range for twilight	0 ... 674 lx
Spectral range	700 ... 1050 nm
Accuracy	10 % (fm. ET)

Temperature

Accuracy	± 1 K (for wind speeds > 0.5 m/s)
----------	-----------------------------------

4 Software description

4.1 Software specification

ETS search paths:	Phys.sensors / Weather station / Weather station standard
Used BAU:	ASIC 1066 + μ C
KNX/EIB type class:	3b device with cert. PhL + stack
Configuration:	S-mode standard
AST type:	No AST
AST connection:	No connector

No.	Short description	Name	Version	from mask version
1	Application version for the ETS2 and ETS3a...c. Detection of the weather data Wind speed, Precipitation, Twilight, Temperature and brightness in 3 directions. Evaluation of the data, in particular limiting value processing. The measured values for wind can be checked for plausibility, and the presence of the 24V power supply can be monitored. Blocking modules can be used to filter 1-bit, 8-bit or 16-bit values. Logic operations (AND, AND with return, OR, exclusive OR) with up to 4 inputs each are available.	Weather station B00901	0.1 for ETS 2 and ETS 3a...c	705
2	Application version for the ETS3d and following. Detection of the weather data Wind speed, Precipitation, Twilight, Temperature and brightness in 3 directions. Evaluation of the data, in particular limiting value processing. The measured values for wind can be checked for plausibility, and the presence of the 24V power supply can be monitored. Blocking modules can be used to filter 1-bit, 8-bit or 16-bit values. Logic operations (AND, AND with return, OR, exclusive OR) with up to 4 inputs each are available.	Weather station B00911	1.1 for ETS 3d...	705

4.2 Software B009x1

4.2.1 Scope of functions

- A temperature sensor determines the outdoor temperature at the weather station's location. The measured value is output as a 16-bit value. Because of its location, the sensor generally measures the temperature in the sun.
- A wind sensor (thermal) determines the wind speed at the weather station's location. The measured value is output as a 16-bit value. A sufficient distance from walls and obstacles must be observed so that the wind is not blocked in any direction, and so that there are no eddies that could corrupt the measured values.
- A twilight sensor determines the brightness in the twilight range. The measured value is output as a 16-bit value.
- Three brightness sensor set at 90° from each other determine the brightness in specific directions during daylight and sunshine. The measured value is output as a 16-bit value. In this manner, for a three-sided conservatory the light intensity can be determined at the three glass surfaces. It must be ensured that there are no objects that could place the sensors in shade, unless they also shade the corresponding side of the building in the same way.
- A precipitation sensor makes a binary determination as to whether rain, snow or hail is falling at the weather station's location. The precipitation sensor's output is in the form of 1-bit values.
- Two limiting values with hysteresis adjustable for each sensor can be parametrized internally or specified externally as 8-bit or 16-bit values. Because the precipitation sensor does not supply any analog signal, no limiting values are available.
- The teaching function makes it possible to accept the current 2-byte measured value as a limiting value. This can be triggered by pressing an external pushbutton, for example.
- All limiting value objects have a parametrizable switch-on and switch-off delay
- 6 logic gates (AND, AND with feedback, OR, exclusive OR, NAND, NOR) with up to 4 inputs for external and internal 1-bit values.
- 4 blocking elements for blocking functions or manual operation.
- Output of all values can take place when values change and cyclically. The outputs of the blocking elements can only be sent when values change.
- Cascading of weather stations is possible using the logic functions. This is advisable for expanded functions (measurement of winds on various sides) or for greatly increased functional reliability through redundancy, for example in the case of very expensive outdoor hangings.

4.2.2 Notes on software

ETS configuration and commissioning

ETS3.0d is recommended for configuration and commissioning of the device. Only with this ETS patch version or a newer version can one make use of benefits with regard to downloading (significantly shorter loading times) and parameter configuration. These benefits result from the use of the new mask version 7.05 and from the parameter depiction of ETS3.

The product database necessary for ETS3.0d is offered in *.VD4 format. The corresponding application program has the version number "1.1". For ETS2 and older versions of ETS3, a separate product database is available in *.VD2 format. The application program for these ETS versions has the version number "0.1".

With regard to the scope of functions of the parameterisation described in this documentation there is no difference between the two application programs.

In the event of an update from older ETS versions to ETS3.0d or to newer versions, an additional tool is available as an ETS3 add-in. This tool is able to convert older product databases with application version "0.1" – for example from existing ETS2 projects – into the new application format (version "1.1"). This makes it possible to make use of the benefits of the ETS3.0d application easily and without changing the configuration. The ETS3 add-in can be obtained separately from the manufacturer, and is free of charge.

4.2.3 Data points

Number of communication objects:	max. 89
Number of addresses (max.):	200
Number of assignments (max.):	200
Dynamic table management:	No
Maximum table length:	400

General

Function:	Brightness measurement				
Object	Function	Name	Type	DPT	Flag
 ^{0, 1, 2, 7}	Brightness 1, Brightness 2, Brightness 3, Max. brightness 1 to 3	Measured value for brightness	2 byte	9.004	C, R, T
Description	2 byte objects for outputting the current measured values of the brightness sensors. The individual sensors are directional. They can be sent when there is a measured value difference and/or cyclically.				

Function:	Twilight measurement				
Object	Function	Name	Type	DPT	Flag
 ³	Twilight	Measured value for twilight	2 byte	9.004	C, R, T
Description	2 byte object for outputting the current measured value of the twilight sensor. The individual sensors are directional. They can be sent when there is a measured value difference and/or cyclically.				

Function:	Temperature measurement				
Object	Function	Name	Type	DPT	Flag
 ⁴	Temperature	Measured value for temperature	2 byte	9.001	C, R, T
Description	2 byte object for outputting the current measured value of the temperature sensor. The object can be sent when there is a measured value difference and/or cyclically. Only visible if the sensor is activated)				

Function:	Measurement of the wind speed in m/s				
Object	Function	Name	Type	DPT	Flag
 ⁵	Wind	Measured value for wind [m/s]	2 byte	9.005	C, R, T
Description	2 byte object for outputting the current measured value of the wind sensor. The object can be sent when there is a measured value difference and/or cyclically.				

Function: Brightness measurement

Object	Function	Name	Type	DPT	Flag
 8	Max. brightness and twilight	Measured value for brightness and twilight	2 byte	9.004	C, R, T

Description 2 byte objects for outputting the current maximum value of the brightness sensors. If this value is lower than 1000 lux, then the current value of the twilight sensor is output. The object can be sent when there is a measured value difference and/or cyclically.

Function: Output for limiting value 1

Object	Function	Name	Type	DPT	Flag
 9, 10, 11, 12, 13, 14, 15, 16, 17	Brightness 1, Brightness 2, Brightness 3, Twilight, Temperature, Wind, Precipitation, Max. brightness 1 to 3, Max. brightness and twilight	Limiting value 1	1 bit	1.001	C, T (R) ¹

Description 1 bit objects for outputting the current limiting value states. The object can be sent when there is a value change and/or cyclically. A switch-on and switch-off delay can be parametrized.

Function: Output for limiting value 2

Object	Function	Name	Type	DPT	Flag
 18, 19, 20, 21, 22, 23, 24, 25, 26	Brightness 1, Brightness 2, Brightness 3, Twilight, Temperature, Wind, Precipitation, Max. brightness 1 to 3, Max. brightness and twilight	Limiting value 2	1 bit	1.001	C, T (R) ¹

Description 1 bit objects for outputting the current limiting value states. The object can be sent when there is a value change and/or cyclically. A switch-on and switch-off delay can be parametrized.

Function: Value specification for brightness and twilight limiting values 1 via external devices

Object	Function	Name	Type	DPT	Flag
 27, 28, 29, 30, 34, 35	Brightness 1, Brightness 2, Brightness 3, Twilight, Precipitation, Max. brightness 1 to 3, Max. brightness and twilight	External limiting value 1	2 byte	9.004	C, S

Description 2 byte objects for specifying the limiting values for brightness and twilight via an external value transmitter.

1: Each communication object can be read out. For reading, the R-flag must be set.

Function: Value specification for temperature limiting value 1 via external devices

Object	Function	Name	Type	DPT	Flag
 ³¹	Temperature	External limiting value 1	2 byte	9.001	C, S

Description 2 byte objects for specifying the limiting value for temperature via external value transmitters.

Function: Value specification for wind limiting value 1 via external devices

Object	Function	Name	Type	DPT	Flag
 ³²	Wind	External limiting value 1	2 byte	9.005	C, S

Description 2 byte objects for specifying the limiting value for wind via external value transmitters.

Function: Specification of brightness and twilight limiting values 1 in percent of the upper range value via external devices

Object	Function	Name	Type	DPT	Flag
 ^{27, 28, 29, 30, 34, 35}	Brightness 1, Brightness 2, Brightness 3, Twilight, Precipitation, Max. brightness 1 to 3, Max. brightness and twilight	External limiting value 1 [%]	1 byte	5.001	C, S

Description 1 byte objects for specifying the limiting values for brightness and/or twilight in percent, relative to the measuring range upper range value of the sensor (110 klx or 674 lux), via an external value transmitter.

Function: Specification of temperature limiting value 1 in percent of the upper range value via external devices

Object	Function	Name	Type	DPT	Flag
 ³¹	Temperature	External limiting value 1 [%]	1 byte	5.001	C, S

Description 1 byte object for specifying the limiting values for the temperature in percent, relative to the measuring range of the sensor (0%=-20°C, 50%=17.5°C, 100%=55°C), via external value transmitters.

Function: Specification of wind limiting value 1 in percent of upper range value via external devices

Object	Function	Name	Type	DPT	Flag
 ³²	Wind	External limiting value 1 [%]	1 byte	5.001	C, S

Description 1 byte object for specifying the limiting value for the wind in percent, relative to the measuring range upper range value of the sensor (40 m/s), via external value transmitters.

Function: Specification of brightness and twilight limiting values 1 by means of teaching function

Object	Function	Name	Type	DPT	Flag
 27, 28, 29, 30, 34, 35	Brightness 1, Brightness 2, Brightness 3, Twilight, Precipitation, Max. brightness 1 to 3, Max. brightness and twilight	External limiting value 1 (teaching)	1 bit	1.001	C, S

Description A change of state of the 0 bit switching objects from '1' to '1', triggered, for example, via an external pushbutton, causes the current measured value of the sensor to be saved as the new limiting value.

Function: Specification of temperature limiting value 1 by means of teaching function

Object	Function	Name	Type	DPT	Flag
 31	Temperature	External limiting value 1 (teaching)	1 bit	1.001	C, S

Description A change of state of the 0 bit switching object from '1' to '1', triggered, for example, via an external pushbutton, causes the current measured value of the sensor to be saved as the new limiting value.

Function: Specification of wind limiting value 1 by means of teaching function

Object	Function	Name	Type	DPT	Flag
 32	Wind	External limiting value 1 (teaching)	1 bit	1.001	C, S

Description A change of state of the 0 bit switching object from '1' to '1', triggered, for example, via an external pushbutton, causes the current measured value of the sensor to be saved as the new limiting value.

Function: Value specification for brightness and twilight limiting values 2 via external devices

Object	Function	Name	Type	DPT	Flag
 36, 37, 38, 39, 43, 44	Brightness 1, Brightness 2, Brightness 3, Twilight, Precipitation, Max. brightness 1 to 3, Max. brightness and twilight	External limiting value 2	2 byte	9.004	C, S

Description 2 byte objects for specifying the limiting values for brightness and twilight via an external value transmitter.

Function: Value specification for temperature limiting value 2 via external devices

Object	Function	Name	Type	DPT	Flag
 40	Temperature	External limiting value 2	2 byte	9.001	C, S

Description 2 byte objects for specifying the limiting value for temperature via external value transmitters.

Function:	Value specification for wind limiting value 2 via external devices				
Object	Function	Name	Type	DPT	Flag
 ⁴¹	Wind	External limiting value 2	2 byte	9.005	C, S
Description	2 byte objects for specifying the limiting value for wind via external value transmitters.				

Function:	Specification of brightness and twilight limiting values 2 in percent of the upper range value via external devices				
Object	Function	Name	Type	DPT	Flag
 ^{36, 37, 38, 39, 43, 44}	Brightness 1, Brightness 2, Brightness 3, Twilight, Precipitation, Max. brightness 1 to 3, Max. brightness and twilight	External limiting value 2 [%]	1 byte	5.001	C, S
Description	1 byte objects for specifying the limiting values for brightness and/or twilight in percent, relative to the measuring range upper range value of the sensor (110 klx or 674 lux), via an external value transmitter.				

Function:	Specification of temperature limiting value 2 in percent of the upper range value via external devices				
Object	Function	Name	Type	DPT	Flag
 ⁴⁰	Temperature	External limiting value 2 [%]	1 byte	5.001	C, S
Description	1 byte object for specifying the limiting values for the temperature in percent, relative to the measuring range of the sensor (0%=-20°C, 50%=17.5°C, 100%=55°C), via external value transmitters.				

Function:	Specification of wind limiting value 2 in percent of upper range value via external devices				
Object	Function	Name	Type	DPT	Flag
 ⁴¹	Wind	External limiting value 2 [%]	1 byte	5.001	C, S
Description	1 byte object for specifying the limiting value for the wind in percent, relative to the measuring range upper range value of the sensor (40 m/s), via external value transmitters.				

Function:	Specification of brightness and twilight limiting values 2 by means of teaching function				
Object	Function	Name	Type	DPT	Flag
 ^{36, 37, 38, 39, 43, 44}	Brightness 1, Brightness 2, Brightness 3, Twilight, Precipitation, Max. brightness 1 to 3, Max. brightness and twilight	External limiting value 2 (teaching)	1 bit	1.001	C, S
Description	A change of state of the 0 bit switching objects from '1' to '1', triggered, for example, via an external pushbutton, causes the current measured value of the sensor to be saved as the new limiting value.				

Function: Specification of temperature limiting value 2 by means of teaching function

Object	Function	Name	Type	DPT	Flag
 40	Temperature	External limiting value 2 (teaching)	1 bit	1.001	C, S

Description A change of state of the 0 bit switching object from '1' to '1', triggered, for example, via an external pushbutton, causes the current measured value of the sensor to be saved as the new limiting value.

Function: Specification of wind limiting value 2 by means of teaching function

Object	Function	Name	Type	DPT	Flag
 41	Wind	External limiting value 2 (teaching)	1 bit	1.001	C, S

Description A change of state of the 0 bit switching object from '1' to '1', triggered, for example, via an external pushbutton, causes the current measured value of the sensor to be saved as the new limiting value.

Function: External inputs of the logic gates

Object	Function	Name	Type	DPT	Flag
 45, 46, 47, 48, 50, 51, 52, 53, 55, 56, 57, 58, 60, 61, 62, 63, 65, 66, 67, 68, 70, 71, 72, 73	Logic gate 1 - 6	Input 1 - 4	1 bit	1.001	C, S

Description 1-bit objects for activation of the logical inputs of the logic gates. Depending on the parameterisation, the inputs can be linked normally inverted 'AND', 'OR', 'exclusive OR' as well as 'AND with return'. Only visible when 'input n' is set to 'external input value'.

Function: Outputs of the logic gates

Object	Function	Name	Type	DPT	Flag
 49, 54, 59, 64, 69, 74	Logic gate 1 - 6	Output	1 bit	1.001	C, T (R) ¹

Description 1 bit output objects of the logic gates. The result of the logic operation can be output normally or inverted. It is possible to parametrize a switch-on and switch-on and switch-off delay, sending at every input event or every change of the state of the output, or cyclic sending.

1: Each communication object can be read out. For reading, the R-flag must be set.

Function: Binary external inputs of the blocking modules

Object	Function	Name	Type	DPT	Flag
 75, 78, 81, 84	Blocking module 1 - 4	Input switching	1 bit	1.001	C, S

Description 1 bit input switching objects of the blocking modules. Depending on the blocking object, the blocking modules switch the value of the input object to the output object. The object is only available in conjunction with output switching.

Function: External 1 byte inputs of the blocking modules

Object	Function	Name	Type	DPT	Flag
 75, 78, 81, 84	Blocking module 1 - 4	Input value 1 byte	1 byte	5.001	C, S

Description 1 byte input objects of the blocking modules. Depending on the blocking object, the blocking modules switch the value of the input object to the output object. The object is only available in conjunction with output value 1 byte.

Function: External 2 byte inputs of the blocking modules

Object	Function	Name	Type	DPT	Flag
 75, 78, 81, 84	Blocking module 1 - 4	Input value 2 byte	2 byte	9.0xx	C, S

Description 2 byte input objects of the blocking modules. Depending on the blocking object, the blocking modules switch the value of the input object to the output object. The object is only available in conjunction with output value 2 byte.

Function: Binary outputs of the blocking modules

Object	Function	Name	Type	DPT	Flag
 76, 79, 82, 85	Blocking module 1 - 4	Output switching	1 bit	1.001	C, T (R) ¹

Description 1 bit output switching objects of the blocking modules. Depending on the blocking object, the blocking modules switch the value of the input objects (depending on the parametrization, this can be an external or internal object, e.g. a limiting value) to the output object. The object is only available in conjunction with input switching.

Function: 1 byte outputs of the blocking modules

Object	Function	Name	Type	DPT	Flag
 76, 79, 82, 85	Blocking module 1 - 4	Output value 1 byte	1 byte	5.001	C, T (R) ¹

Description 1 byte output objects of the blocking modules. Depending on the blocking object, the blocking modules switch the value of the external input object to the output object. No internal 1 byte values are present in this multiple sensor. The object is only available in conjunction with input value 1 byte.

1: Each communication object can be read out. For reading, the R-flag must be set.

Function: 2 byte outputs of the blocking modules

Object	Function	Name	Type	DPT	Flag
 76, 79, 82, 85	Blocking module 1 - 4	Output value 2 byte	2 byte	9.0xx	C, T (R) ¹

Description 2 byte output objects of the blocking modules. Depending on the blocking object, the blocking modules switch the value of the input objects (depending on the parametrization, this can be an external or internal object, e.g. a measured value) to the output object. The object is only available in conjunction with input value 2 byte.

Function: Blocking the blocking modules

Object	Function	Name	Type	DPT	Flag
 77, 80, 83, 86	Blocking module 1 - 4	Blocking object	1 bit	1.001	C, S

Description Depending on these 1 bit input objects, the blocking elements will switch the input value through to the output. The blocking module can block when there is a 0 telegram or 1 telegram of the blocking object. It is possible to parametrize the blocking response when the Multisensor is initialized.

Monitoring

Function: Checking the wind signal for a malfunction

Object	Function	Name	Type	DPT	Flag
 87	Monitoring	Wind unchanged	1 bit	1.001	C, T (R) ¹

Description 1 bit output object for checking the wind sensor for malfunctions. If a constant signal is measured for longer than the parametrized time 'wind unchanged in minutes', then it will be assumed that there is a malfunction in the wind sensor. This object can be used to move outdoor equipment that is vulnerable to winds, such as awnings or outdoor shutters to a safe position, and to report the suspected defect.

Function: Checking the wind signal for a malfunction

Object	Function	Name	Type	DPT	Flag
 88	Monitoring	No wind	1 bit	1.001	C, T (R) ¹

Description 1-bit output object for checking the wind sensor for defects. If a signal of 0 m/s is measured for longer than the parameterisable time for 'no wind in hours', then it is assumed that there is a defect in the wind sensor. This object can be used to move vulnerable outdoor equipment, such as awnings or outdoor blinds, to a safe position, and to report the suspected defect.

1: Each communication object can be read out. For reading, the R-flag must be set.

Function:	Checking of the external voltage 24 V voltage supply				
Object	Function	Name	Type	DPT	Flag
 ⁸⁹	Monitoring	Heating voltage OK	1 bit	1.001	C, T (R) ¹
Description	1 bit output object for checking whether the correct external supply voltage is present to supply power to the heater. Reliable detection of precipitation is only possible when the correct supply voltage is present. This object can be used to move outdoor equipment that is vulnerable to precipitation, for example awnings, to a protected position, and to report the suspected defect.				

1: Each communication object can be read out. For reading, the R-flag must be set.

4.2.4 Functional description

4.2.4.1 Application-oriented functional description

Protecting outdoor equipment against the effects of weather

The weather station makes it possible to protect outdoor equipment and facade elements against damage from weather. In general, such outdoor equipment and facade elements, such as awnings and externally mounted shutters, are endangered by the following three weather effects.

- Danger from wind
- Danger from frost
- Danger from precipitation

Which of these weather effects endangers the outdoor equipment, and to what extent, depend on the facade elements themselves. For precise information, please refer to the technical data and descriptions from the manufacturer in question.

Protection of outdoor systems against damage from frost

In order to protect awnings, outdoor shutters or other vulnerable hangings against icing, there are two factors that need to be taken into consideration.

For one thing, when the temperature drops below about 3°C vulnerable hangings, such as awnings for example, should generally be retracted.

Should glare protection by outdoor blinds be maintained even at temperatures below 3°C, then the precipitation should also be considered as an additional factor in possible icing. In this case the blinds are only moved up if the temperature drops below 3°C and precipitation is falling. When the precipitation stops, the danger of icing remains until the temperature rises above the limiting value of approximately 3°C. Only then should the awning be extended again.

i Be sure here to observe the instructions from the manufacturer of the facade elements.

Parametrizing anti-icing protection depending on temperature and precipitation

To fulfil this task, two simple logic gates have to be combined. The first one is used for activation, and the other one for deactivation of the anti-icing protection.

Activation of the anti-icing protection

The temperature and the precipitation sensor and at least two of the six logic gates must be freely available in the device and activated.

Adjustments for the temperature sensor:

- Select the 'Temperature sensor' simply by clicking on it.
- Select 'Limiting values': 'Limiting value 1 activated' (if you also need a limiting value for a different application, then select 'Limiting values 1 and 2 activated')
- Select the 'Temperature sensor limiting value *n*' simply by clicking on it.
- Select 'Limiting value *n*': '3°C'.
- Select 'Hysteresis limiting value *n* in K': '2 K'.
- Select 'Activation limiting value *n*': 'Undershooting LV=EIN, Exceed LV+Hyst.=OFF.

Adjusting the precipitation sensor:

- Select 'Precipitation' simply by clicking on it.
- Select 'Limiting values': 'Limiting value 1 activated' (if you also need a limiting value for a different application, then select 'Limiting values 1 and 2 activated')
- Select 'Precipitation limiting value *n*' simply by clicking on it.
- Select 'Limiting value *n*': 'ON when raining'.
- Select 'Switch-on delay': 'No delay'.
- For 'Switch-on delay': select '15min delay', for example.

Settings of the logic gate:

- Select a free activated gate simply by clicking on it.

- Select the 'Type of logic operation': 'AND'.
 - Select 'Send output at': 'Every input event'
 - Select 'Number of inputs': '2'.
 - Select 'Response of output:' 'normal'
 - Select 'Switch-on delay': 'No delay'.
 - Select 'Switch-off delay': 'No telegram'.
 - Select 'Cyclic sending of the output', for example '60', for example to increase reliability if the actuator allows it (without noise).
- i** If a jerking of the blinds can be heard with each telegram, then select '0' for do not send cyclically.
- Select 'Logic gate n inputs' simply by clicking on it.
 - Select 'Input 1': 'Internal input value'
 - Select response 'Input 1': 'Normal'
 - Select 'Assign input 1': 'Temperature LV n '
 - Select 'Input 2': 'Internal input value'
 - Select response 'Input 2': 'Normal'
 - Select 'Assign input 2': 'Precipitation LV n '.
 - Apply the output to the safety input of the actuator.

The activation of the anti-icing protection responds according to the following logic.

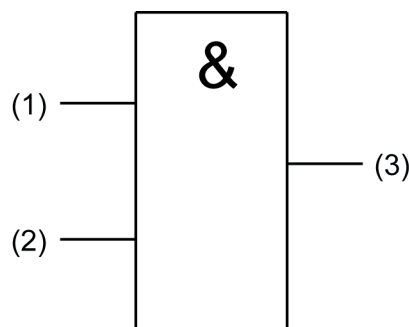

Figure 8: Activation of anti-icing protection

- (1) Limiting value n temperature
- (2) Limiting value n precipitation
- (3) Output logic gate n for activation of the anti-icing protection

i Only one ON telegram is sent. The OFF telegram is suppressed.

Deactivation of the anti-icing protection

Activation of the anti-icing protection must have been carried out as described above.

- Select a free activated gate simply by clicking on it.
- Select the 'Type of logic operation': 'AND'.
- Select 'Send output at': 'Every input event'
- Select 'Number of inputs': '1'.
- Select 'Response of output:' 'normal'
- Select 'Switch-on delay': 'No telegram'.
- Select 'Switch-off delay': 'No delay'.

- Select 'cyclic sending of the output', for example '60', in order to increase safety if the actuator or the blinds allow it (without noises).
 - ❗ If a jerking of the blinds can be heard with each telegram, then select '0' for do not send cyclically.
 - Select 'Logic gate n inputs' simply by clicking on it.
 - Select 'Input 1': 'Internal input value'
 - Select response 'Input 1': 'Normal'
 - Select 'Assign input 1': 'Temperature LV n '
 - Apply the output to the safety input of the actuator.
- The deactivation of the anti-icing protection responds according to the following logic.

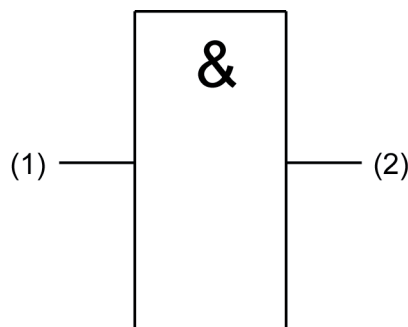

Figure 9: Deactivation of the anti-icing protection

- (1) Temperature limiting value n
 - (2) Output logic gate n for deactivation of the anti-icing protection
 - ❗ Only an OFF telegram is sent. The ON telegram is suppressed.
- The following time diagram provides an explanation of the mode of operation.

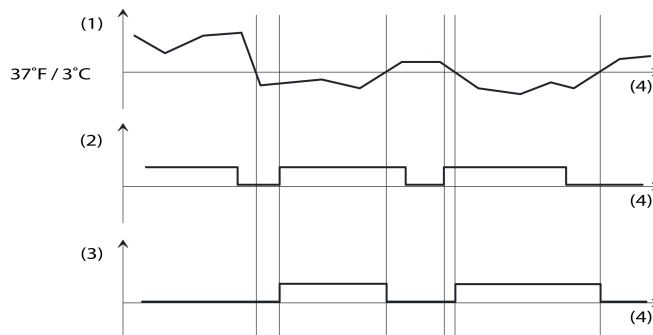

Figure 10: Anti-icing protection depending on temperature and precipitation

- (1) Measured temperature curve
- (2) Signal of the precipitation sensor
- (3) Both output signal for control of the actuator are connected with the safety input.
- (4) Time axis

Plausibility check of the wind measurement

Besides simple measurement of the wind speed, the weather station also provides the option of checking the measurement results for plausibility. To do this, set the times for 'No wind' and 'Wind unchanged' in accordance with local conditions. Ask local meteorological stations for reasonable values.

The set limiting value is linked logically OR with the monitoring function 'No wind' and 'Wind

unchanged'. In order to further increase reliability in the event of incorrect measurements, you can also link the limiting value of an additional wind sensor via an additional input of the OR gate. This function is explained in the following function illustration.

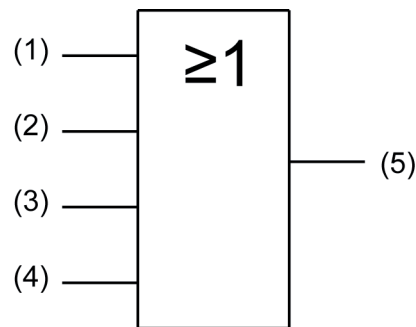

Figure 11: Gating of the signals

- (1) Wind LV1 or LV2
- (2) Monitoring 'No wind'
- (3) Monitoring 'Wind unchanged'
- (4) If necessary limiting value of the external wind sensor
- (5) Link the output of the gate with the safety inputs of the outdoor equipment actuators.

Protection of outdoor equipment against damage from wind.

The weather station is equipped with a wind sensor which determines the wind speed thermally. It is possible to move the outdoor equipment to a protected position by means of two parametrizable limiting values via a corresponding input of the actuator. In the case of large buildings or convoluted layouts it may be advisable to combine a number of additional wind sensors and to link them as a logical OR via one of the 6 logic gates. Beside simply measuring the wind speed, the weather station also provides the option of checking the measured results for plausibility.

The wind speed is usually indicated in metres per second or in kilometres per hour. Since 1806 there has been a subdivision into speed levels developed by Sir Francis Beaufort. For this reason the unit for wind speed is named for him. It is abbreviated "bft". The following table provides an overview of the various wind speed levels; this is intended to make it easier for you to set parameters with reasonable values.

bft	m/s	km/h	Designation	Description
0	0.0 ... 0.4	0.0 ... 1.8	Calm	No air movement. Smoke rises vertically.
1	0.5 ... 2.0	1.9 ... 7.3	Light air	Wind hardly noticeable, wind motion visible in smoke, no motion in wind vanes
2	2.1 ... 3.5	7.4 ... 12.9	Light breeze	Leaves rustle, wind felt on face
3	3.6 ... 5.6	13.0 ... 20.3	Gentle breeze	Leaves and smaller twigs in constant motion
4	5.7 ... 8.1	20.4 ... 29.5	Moderate breeze	Small branches move, loose paper is picked up from the ground
5	8.2 ... 11.2	29.6 ... 40.6	Fresh breeze	Larger branches and trees in motion, wind clearly audible
6	11.3 ... 14.3	40.7 ... 51.8	Strong breeze	Large branches in motion. Whistling heard in overhead wires.

7	14.4 ... 17.4	51.9, ... 63.8	Near gale	Whole trees in motion. Effort needed to walk against the wind.
8	17.5 ... 21.0	63.9 ... 75.8	Gale	Large trees in motion, twigs broken from trees, very difficult to walk
9	21.1 ... 24.6	75.9 ... 88.8	Strong gale	Branches broken from trees, roof tiles torn from houses.
10	24.7 ... 28.7	88.9 ... 103.6	Storm	Trees uprooted, damage to houses
11	28.8 ... 32.8	103.7 ... 118.4	Violent storm	Powerful gusts, widespread structural damage
12	Over 32.8	Over 118.4	Hurricane	Considerable and widespread damage to structures

Assessment of wind speeds

Adjusting protection of outdoor equipment against damage from wind

The wind sensor and at least one of the six logic gates must be available and activated on the device.

Adjusting the wind sensor:

- Select the 'Wind sensor'.
- Select 'Limiting values': 'Limiting value 1 activated' (if you also need a 2nd limiting value for a different application, then select 'Limiting values 1 and 2 activated')
- Select 'Wind sensor limiting value *n*' simply by clicking on it.
- Select 'Limiting value *n*': 'x m/s'
- i** For the value for wind strength 'x' at which the element should be moved to a protected position, please consult the manufacturer's instructions for the element to be protected.
- Select 'Hysteresis limiting value *n* in m/s': for example '5 m/s'.
- Select 'Activation limiting value *n*': 'Exceed LV=ON, Undershoot LV hysteresis=OFF'.

Adjusting the monitoring function:

- Select 'Monitoring' simply by clicking on it.
- Select 'Monitor wind signal': 'Monitor'.
- Select the max. time for 'No wind': a value appropriate to the location, for example '10'
- Select the max. time for 'Wind unchanged': a value appropriate to the location, for example '10'
- i** Please ask the responsible meteorological station for the location for the appropriate times.
- i** The monitoring bits are sent with every change of state independently of the setting 'Cycl. sending of the monitoring bits'. The internal evaluation follows immediately after the object value, i.e. if the value is sent cyclically, then it is also evaluated internally.

Settings of the logic gate:

- Select a free activated gate simply by clicking on it.
- Select the 'Type of logic operation': 'OR'.
- Select 'Send output at': 'Every input event'
- i** If the shutters are often heard to jerk without a change of position, then select 'Send output at' 'Change of the output'.
- Select 'Number of inputs': '3'.
- Select 'Response of output': 'normal'
- Select 'Switch-on delay': 'No delay'.
- Select 'Switch-off delay': 'No delay'.

- Select 'Cyclic sending of the output', for example '30', for example to increase reliability if the actuator allows it (without noise).
 - ❏ If a jerk can be heard with each telegram, then select '0' for do not send cyclically.
 - Select 'Logic gate n inputs' simply by clicking on it.
 - Select 'Input 1': 'Internal input value'
 - Select 'Response input 1': 'Normal'
 - Select 'Assign input 1': 'Wind LV n '
 - Select 'Input 2': 'Internal input value'
 - Select 'Response input 2': 'Normal'
 - Select 'Assign input 2': Monitoring 'Wind sensor'
 - Select 'Input 3': 'Internal input value'
 - Select 'Response input 3': 'Normal'
 - Select 'Assign input 3': Monitoring 'Wind sensor iced'
 - Apply the output to the safety input of the actuator.
- The control of the wind alarm responds according to the following logic.

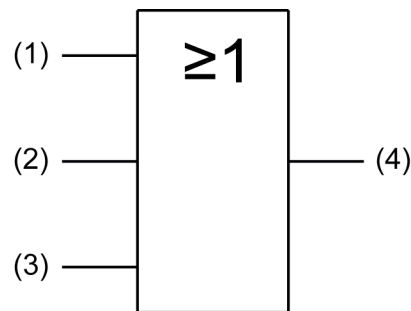

Figure 12: Logic for controlling the wind alarm

- (1) Wind sensor limiting value n
- (2) Wind unchanged
- (3) Wind unchanged
- (4) Output logic gate n

- ❏ To increase safety, the limiting value of an additional wind sensor can be integrated via an additional input.

Protecting outdoor equipment against damage from water

To detect rain, snow and sleet the weather station is equipped with a resistive precipitation sensor. It uses a meander-shaped conductive strip, and evaluates the conductivity of the rainwater. In contrast to the other weather sensors, the precipitation sensor does not provide any analog measured values, but rather sends a switching telegram with a settable value as soon as precipitation is detected. .

- ❏ The precipitation sensor must in all cases have a proper 24V supply voltage. If this is not present, or if the voltage is incorrect, then precipitation will be reported. If the supply voltage fails during operation, a precipitation telegram is sent twice.

4.2.4.2 Sensor function

Brightness sensors

The weather station has separate sensors for each of three directions, for example the three sides of a conservatory. The sensors all have the same settings. The three detection ranges of the sensors overlap somewhat in order to be able to follow the course of the sun properly.

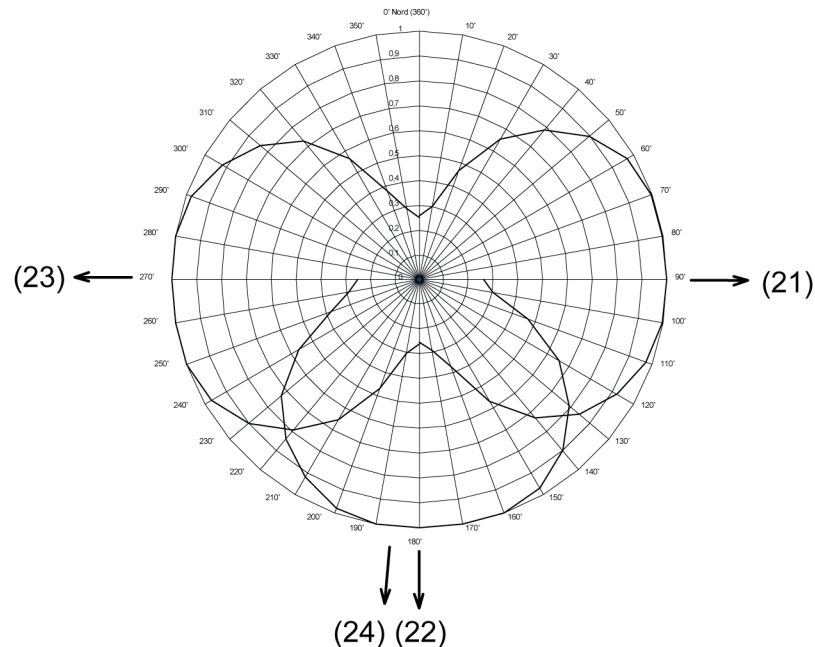

Figure 13: Circular chart for brightness detection

- (21) Orientation of brightness sensor 1
- (22) Orientation of brightness sensor 2
- (23) Orientation of brightness sensor 3
- (24) Orientation of the twilight sensor

The measurement range covers 0 to 110,000 lux. The values are sent via 2-byte objects. For measured values below 1000 lux, the value 0 lux is output. In order to display the current illumination, the measured value can be sent when there is a settable difference relative to the measurement range upper range value. Cyclic sending of the values is also possible. For each sensor, two settable limiting values are available, for each of which the weather station can transmit switching telegrams when they are exceeded or undershot. There is the option of setting these limiting values internally and permanently, or externally and variably, for example using visualisation software. The settings for the limiting values and the hysteresis is the same for all analog sensors, and is described in detail in the section "Limiting value settings".

- i** Before the sensor can be parametrized, it has to be activated on the parameter page 'General'.

Twilight sensor

To detect twilight, a separate linear sensor is built in that determines the illumination from the direction of brightness sensor 2 (24). The measurement range covers from 0 to 674 lux, and is sent via a 2-byte object. In order to display the current illumination, the measured value can be sent when there is a settable difference relative to the measurement range upper range value. Cyclic sending of the values is also possible. Two settable limiting values are available, for each of which the weather station can transmit switching telegrams when they are exceeded or undershot. There is the option of setting these limiting values internally and permanently, or externally and variably, for example using visualisation software. The settings for the limiting values and the hysteresis is the same for all analog sensors of the weather station. This is described in detail in the section "Limiting value settings".(Figure 13)

- i** Before the sensor can be parametrized, it has to be activated on the parameter page 'General'.

Temperature sensor

For temperature detection, a sensor is built into the weather station that determines the temperature at the location. The measurement range covers from -20 to +55 °C, and is sent via a 2-byte object. In order to display the current temperature, the measured value can be sent when there is a settable difference relative to the measurement range upper range value. Cyclic sending of the values is also possible. The values are sent in the same manner for all of the sensors. Two settable limiting values are available, for each of which the weather station can transmit switching telegrams when they are exceeded or undershot. There is the option of setting these limiting values internally and permanently, or externally and variably, for example using visualisation software. A teaching function is also available, which can save the current measured value as a limiting value at the press of a button. The settings for the limiting values and the hysteresis is the same for all analog sensors of the weather station. This is described in detail in the section "Limiting value settings".

- i** Before the sensor can be parametrized, it has to be activated on the parameter page 'General'.
- i** Direct sunlight affects the temperature measurement.

Wind sensor

The weather station has two temperature sensors for determining the wind strength. One temperature sensor is mounted so that it is protected against the wind, while the wind can flow around the other sensor. The temperature difference between the two sensors is used to determine the current wind speed. The preconfigured measurement range covers 0 ... 40 m/s. An accuracy of +/- 2 m/s is maintained at an outdoor temperature of -20°C ... +55°C. At lower outdoor temperatures the accuracy may be somewhat worse. If, for example, the weather station is mounted near an exhaust air outlet, then it is not possible to guarantee that icing will not occur in the event of bad weather conditions.

To display the current wind speed, the measured value can be sent when a settable difference is present relative to the measurement range upper range value. Cyclic sending of the values is also possible. The values themselves are sent in the same manner for all of the sensors. Two settable limiting values are available, for each of which the weather station can transmit switching telegrams when they are exceeded or undershot. There is the option of setting these limiting values internally and permanently, or externally and variably, for example using visualisation software. A teaching function is also available, which can save the current measured value as a limiting value at the press of a button. The settings for the limiting values and the hysteresis is the same for all analog sensors of the weather station. This is described in detail in the section "Limiting value settings".

- i** Before the sensor can be parametrized, it has to be activated on the parameter page 'General'.
- i** The wind signal can be checked for plausibility with the aid of the monitoring function.

Precipitation sensor

To detect precipitation, the weather station is equipped with a resistive sensor that forms the sloped roof of the housing. If precipitation, e.g. heavy fog, rain or snow appears there, then it is detected via the conductivity between the waves. Unlike the weather station's other sensors, this value is not analog, but rather binary: 'Precipitation' or 'No precipitation'. Therefore the measured result is output directly via the limiting values. There is no measured value object. Operation of the precipitation sensor is only possible if a 24 V supply voltage is connected. The sensor is equipped with a heater to provide faster drying after a rain shower and to protect against icing in the specified temperature range.

Limiting values, with the exception of the hysteresis and external specification, are set in the same way as the weather station's analog sensors. This is described in detail in the section.

- i** Reliable operation of the precipitation sensor is only possible when the correct 24 V power supply is present.
- i** Before the sensor can be parametrized, it has to be activated on the parameter page 'General'.

Sending the measured values

All of the measured values of the analog sensors, that is all of them other than the precipitation sensor, can be sent cyclically and/or when the measured value changes. Sending of the values when there is a change takes place independently of the cyclic sending, i.e. sending when there is a change takes place in addition between the telegrams of the cyclic sending.

- i** The measured value of the precipitation sensor is processed in the form of the two limiting values. The setting is described under Limiting values.

Setting sending of the analog measured values when there is a change

The corresponding sensor must be activated under the general settings, and the parameters must be visible in the ETS.

- Select the desired sensor and mark it.
- In the item "Send measured value when", select between 0.5% measured value difference, 1% measured value difference, 3% measured value difference and 10% measured value difference. The percentage figure refers to the upper range value of the corresponding measurement range of the sensor.
Example: The setting for the twilight sensor (measuring range 0...674 lux) is sending when 1% measured value difference. Only when the signal changes by about 7 lux upwards or downwards will the object be sent again.

- i** Because the measured value difference of the temperature sensor (measurement range -20...55°C) has its zero point shifted into the negative, it is calculated with an upper range value of 75 K.
- i** A general sending delay of 10 s is set permanently.

Cyclic sending of the measured values

All measured value objects of the analog sensors can be sent cyclically using the parameter 'cyclic sending of the measured value'.

- i** Measured value telegrams 'Sending of measured value for value change' that are generated have no effect on the cycle time for the cyclic sending of limiting value objects.
- i** Because it has a purely binary function, the precipitation sensor has no measured value object. Its measured values are processed in the form of two limiting values.

Setting cyclic sending of a measured value

The sensor for which cyclic sending of the measured value is to be set is 'Activated' under the parameter page 'General'

- For the parameter 'cycl. sending of measured value *n*', select a value between 0 and 120
- i** The value range to be set is from 0 to 120. The value has to be multiplied by 10 seconds to obtain the cycle time.
- i** '0' means that the measured value is not sent cyclically.
The measured value is sent at the set interval.

Limiting value settings

All of the analog measured values of the sensors can be assigned with two limiting values. This makes it possible to trigger actions when the adjustable limits are exceeded or undershot. For example, you can lower shutters to protect against glare once a certain brightness is reached. The following settings are necessary to fully parametrize an activated limiting value:

- Select the parametrized value for 'Limiting value *n*' according to the list.
- Select the amount of 'Hysteris 'Limiting value *n*' according to the list.
- Specify the response in the event of exceeding and undershooting in parameter 'Activation limiting value *n*' from the list.
- For the parameter 'External limiting value *n*', specify if necessary whether the limiting value is to be specified externally.
- Define the time 'Switch-on delay limiting value *n*' according to the list.
- Select the time 'Switch-off delay limiting value *n*' according to the list.

- Define whether 'Sending of limiting value n for value change' should take place (analog sensors).
- Define whether, and if so, at what interval the 'cycl. sending of limiting value n ' should take place.
- i** In the case of the binary precipitation sensor, the measurement result is treated directly as a limiting value. The parameters 'Hysteresis limiting value n ', 'Activation limiting value n ' and 'External limiting value n ' are not available for this sensor.

Types of limiting value specification

The value of a limiting value itself can be specified in three ways.

- Limiting value specification via the parametrization. This is the value that sets itself after initialization or after a download. This value can be overwritten via an external object or the teaching function
- Limiting value specification via an external object. This value overwrites permanently the value of the limiting value specification via the parametrization.
- Limiting value specification via the teaching function. This function makes it possible to define the current measured value as the limiting value by pressing an external pushbutton. This value overwrites permanently the value of the limiting value specification via the parametrization.
- i** Once the value of the limiting value specification is overwritten by means of parameterisation, this value remains lost until the weather station is re-initialised due to a bus voltage failure or a new download is carried out via ETS.

Setting limiting value specification via parametrization

The limiting value specification for the limiting values 'Brightness 1', 'Brightness 2', 'Brightness 3', 'Max. brightness 1 to 3', 'Twilight', 'Max. brightness and twilight', 'Temperature' and 'Wind' are set by means of the parameter 'Limiting value n '.

The desired *measured value* must be activated under the general settings, and the parameters must be visible in the ETS.

'Limiting value 1 activated' or 'Limiting values 1 and 2 activated' is set for the *measured value*.

- Select '*Measured value* limiting value 1' or '*Measured value* limiting value 2'.
- In input field 'Limiting value n ', select the desired value from the list.

i This value is loaded to the device during initialization and renewed download.

i The set value is retained until it is overwritten by an external value.

Hysteresis of the limiting values

The weather station has two limiting values for each analog measured value. Each limiting value has a settable hysteresis and a definition for the response to undershooting or exceeding. The hysteresis itself serves to prevent frequent switching backwards and forwards when there is a measured value in the approximate area of the limiting value. This can be used, for example, to prevent blinds from constantly moving up and down. For this reason, select this value as large as possible. These circumstances are explained in the following diagrams.

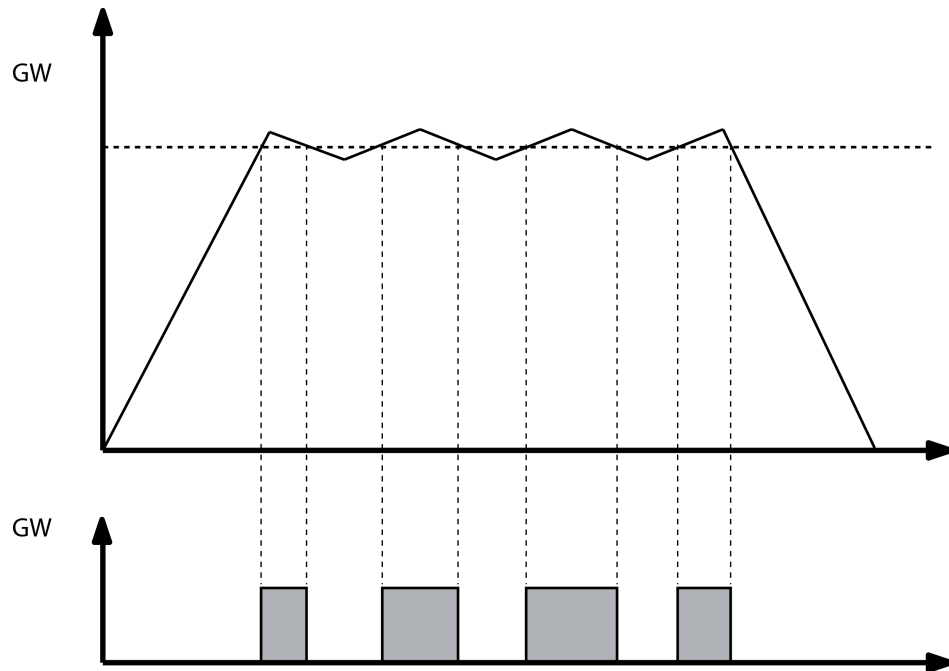

Figure 14: Frequency of switching without hysteresis

One can see here that when no hysteresis is incorporated the limiting value object changes its state each time the value is undershot or exceeded. This is different if you parameterise a change of state from '1' to '0' only when the limit value is undershot by the measured value minus hysteresis.

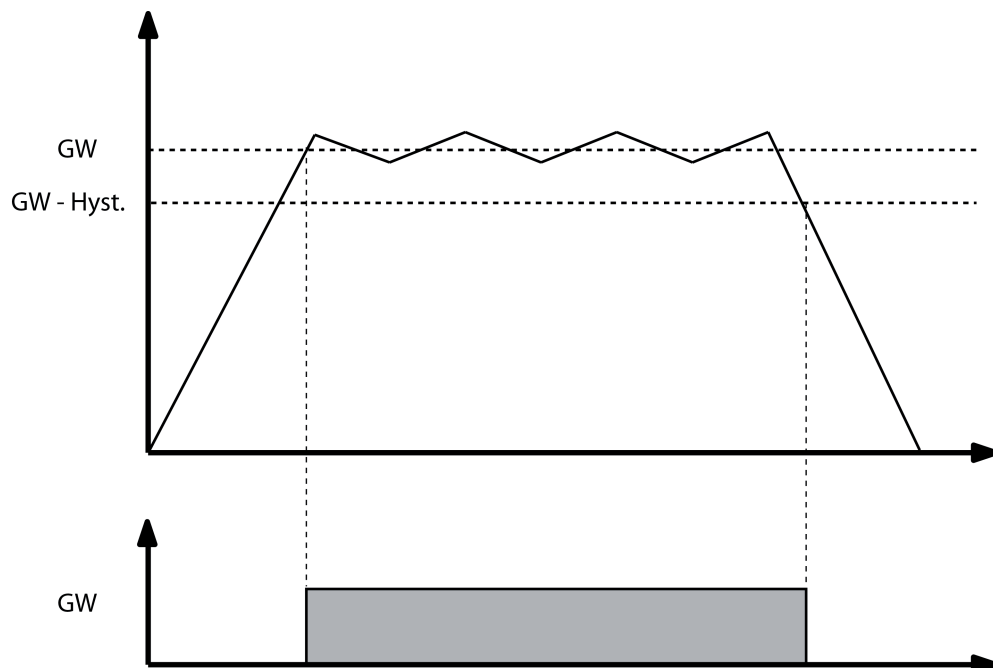

Figure 15: Frequency of switching with hysteresis parameterised.

- i Select the size of the hysteresis so that the beginning of the measuring range is not reached or undershot, and the upper range value is not reached or exceeded, because otherwise a change of state will take place only once, and cannot take place again until there is a re-initialisation.

Setting the hysteresis of the limiting value

The hysteresis of the measured values 'Brightness 1', 'Brightness 2', 'Brightness 3', 'Max. brightness 1 to 3', 'Twilight', 'Max. brightness and twilight', 'Temperature' and 'Wind' is set using the parameter 'Hysteresis limiting value n '

The desired *measured value* must be activated under the general settings, and the parameters must be visible in the ETS.

'Limiting value 1 activated' or 'Limiting values 1 and 2 activated' is set for the *measured value*.

- Select '*Measured value* limiting value 1' or '*Measured value* limiting value 2'.
- Select 'Hysteresis limiting value n ' and select the appropriate value from the list.

The hysteresis is set.

Response of the limiting value object when the limiting value is exceeded and undershot

For the parameter 'Activation limiting value n ', a direction-dependent setting is made for how the limiting value responds when the set limiting value is exceeded or undershot. If for example 'Undershoot LV=ON, Exceed LV+Hyst.=OFF' is selected, then when the limiting value is undershot the limiting value object is set to '1', and the limiting value object is only set to '0' when the limiting value plus hysteresis is exceeded.

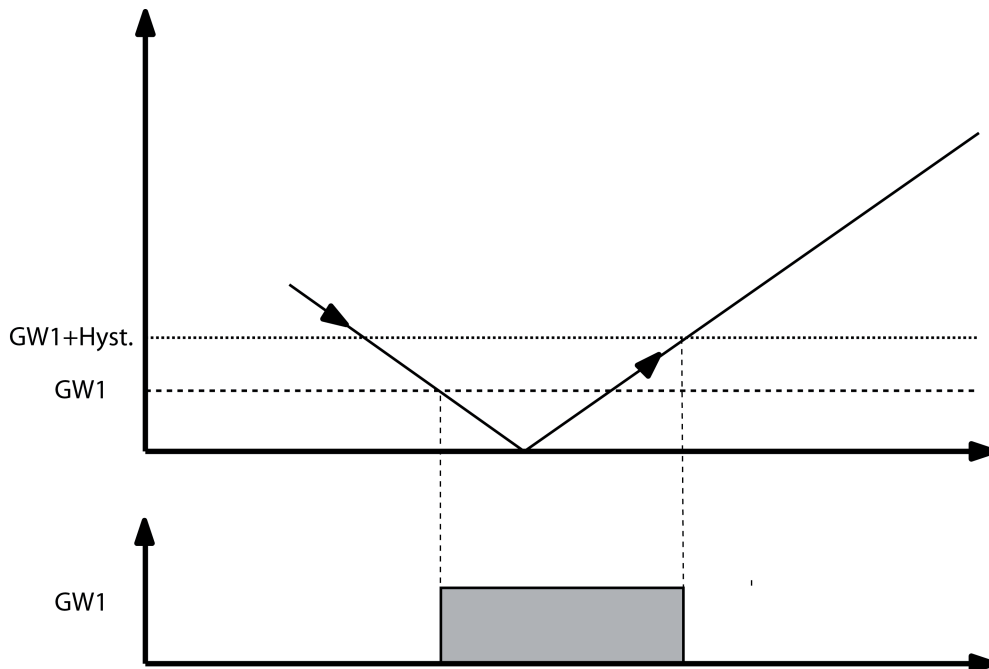

Figure 16: Activation of limiting value

If 'no. telegr.', i.e. no telegram, is parameterised for a channel, then cyclic sending of the limiting value n is also blocked when this function is activated. The cyclic sending of this limiting value remains interrupted until the opposite state is reached again.

Example: Parametrisation is Undershoot LV=ON, Exceed LV+Hyst.=no telegr.

- When the limiting value is undershot, an ON telegram is sent. If 'cycl. sending of the limiting value n ' is parameterised with '10', then an ON telegram is additionally sent every 100 seconds (10sx10).

- When the limiting value plus hysteresis is exceeded, no telegram is sent and the cyclic sending is suppressed.

- When the limiting value is undershot again an ON telegram is sent again, and cyclic sending of this ON telegram is activated again.

Setting response of the limiting value object when the limiting value is exceeded and undershot

The sensor for which the limiting value is to be set must be 'Activated' under the parameter page 'General'

On the parameter page of the sensor, for example 'Twilight', the desired 'Limiting value n activated' is set

- For the parameter 'Activation limiting value n ', select a response from the list.

The following variants are possible:

- Exceed LV=ON , Undershoot LV-Hyst.=OFF
- Exceed LV=OFF , Undershoot LV-Hyst.=ON
- Undershoot LV=ON , Exceed LV+Hyst.=OFF
- Undershoot LV=OFF , Exceed LV+Hyst.=ON
- Exceed LV=ON , Undershoot LV-Hyst.=no telegr.
- Exceed LV=OFF , Undershoot LV-Hyst.=no telegr
- Undershoot LV=ON , Exceed LV+Hyst.=no telegr.
- Undershoot LV=OFF , Exceed LV+Hyst.=no telegr.
- Exceed LV=no telegr. , Undershoot LV-Hyst.=OFF
- Exceed LV=no telegr. , Undershoot LV-Hyst.=ON
- Undershoot LV=no telegr. , Exceed LV+Hyst.=OFF
- Undershoot LV=no telegr. Exceed LV+Hyst.=ON

The desired response of the limiting value is set.

- i** If 'No telegr.' is parametrized for a state, then the sending of the limiting value object is suppressed for the time period in which the condition is fulfilled.

Specifying limiting values via external objects

If you want limiting values to be adjustable during ongoing operation of the building, then the parameter 'External limiting value n ' can be set to '16 bit value' or '8 bit value'. These communication objects 'External limiting value n ' (16 bit) and 'External limiting value n [%]' (8 bit) can be linked, for example, with the transmitter objects of an external pushbutton.

- i** If value specification is to be triggered by a pushbutton, then this pushbutton should be parametrized in such a way that it sends the parametrized value only after it is pressed for a longer period (over 3 seconds).
- i** Limiting value specification via external objects is not available for the measured value 'Precipitation'.

Limiting value specification via teaching function

For the user to be able to use the current measured value as a new limiting value without knowing the numerical value itself, the parameter 'External limiting value n ' can be set to 'Save limiting value via switching object (teaching)'. As soon as this object 'External limiting value n (teaching)' receives a telegram with the value "1", the weather station takes the last measured value as the new limiting value. Telegrams with the value "0" are ignored.

- i** If the teaching function is to be triggered by a pushbutton, then this pushbutton should be parametrized in such a way that it sends the value "1" only after it is pressed for a longer period (over 3 seconds).
- i** The teaching function is not available for the measured value 'Precipitation'.

Setting limiting value specification via external objects or by means of teaching

The limiting value specification via an external object for the measured values 'Brightness 1', 'Brightness 2', 'Brightness 3', 'Max. brightness 1 to 3', 'Twilight', 'Max. brightness and twilight', 'Temperature' and 'Wind' are set by means of the parameter 'External limiting value n '.

The desired *measured value* must be activated under the general settings, and the parameters must be visible in the ETS.

'Limiting value 1 activated' or 'Limiting values 1 and 2 activated' is set for the *measured value*.

- Select '*Measured value* limiting value 1' or '*Measured value* limiting value 2'.
- In input field 'External limiting value n ', select from the list whether (and if so, when) the value should be saved via a 8 bit value, a 16 bit value or the limiting value via a switching object (teaching)

- i** The set value overwrites the limiting value specification via parametrization until it is overwritten by an external value.
- i** This value is overwritten by the value 'Limiting value specification via parametrization' during initialization and any new download.

Switch-on and switch-off delay of the limiting values

All limiting values of the weather station can be given switch-on and switch-off delays. It must be noted here that changing this delay affects not only sending when there is a change, but also cyclic sending of the limiting value object.

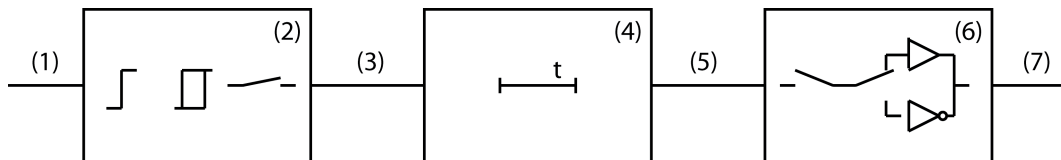

Figure 17: Block diagram for switch-on and switch-off delay

- (1) Measured value
- (2) Limiting value and hysteresis processing
- (3) Internal limiting value
- (4) Switch-on and switch-off delay
- (5) Delayed, internal limiting value
- (6) Processing of cyclic sending, sending when change, activation of limiting value
- (7) Limiting value object

When the value of an internal limiting value (3) changes from '0' to '1', the parameter value of the switch-on delay is evaluated. When the value of an internal limiting value changes from '1' to '0', the parameter value of the switch-off delay is evaluated. If "no delay" is set, then the value of the delayed internal limiting value immediately takes the value of the internal limiting value. When a delay time is set, a timer with the delay time (4) is loaded and started. Only when it expires is the value of the internal limiting value accepted as the value for the delayed internal limiting value (5) and the limiting value sent in accordance with the parameterisation. The cyclic sending is also affected by this delay. If the internal limiting value changes before the timer expires, then it is stopped and the limiting value remains unchanged. Consequently no limiting value telegram initiated by the parameter 'Sending of limiting value n for value change' is sent, either.

Setting the switch-on delay

For all limiting values, including the states of the precipitation sensor, it is possible to set a switch-on delay by means of the parameter 'Switch-on delay limiting value n '

The desired *measured value* must be activated under the general settings, and the parameters must be visible in the ETS.

'Limiting value 1 activated' or 'Limiting values 1 and 2 activated' is set for the *measured value*.

- Select '*Measured value* limiting value 1' or '*Measured value* limiting value 2'.
 - Select 'Switch-on delay limiting value n ' and select the appropriate value from the list.
- The switch-on delay is set.

Setting the switch-off delay

For all limiting values, including the states of the precipitation sensor, a switch-off delay can be set using the parameter 'Switch-off delay limiting value n '.

The desired *measured value* must be activated under the general settings, and the parameters must be visible in the ETS.

'Limiting value 1 activated' or 'Limiting values 1 and 2 activated' is set for the *measured value*.

- Select '*Measured value* limiting value 1' or '*Measured value* limiting value 2'.

- Select 'Switch-off delay limiting value n ' and select the appropriate value from the list.
The switch-off delay is set.

Setting sending of a limiting value of an analog sensor when there is a change

The limiting values of the measured values 'Brightness 1', 'Brightness 2', 'Brightness 3', 'Max. brightness 1 to 3', 'Twilight', 'Max. brightness and twilight', 'Temperature' and 'Wind' can be sent when their value changes using the parameter 'Send limiting value when changed'.

The desired *measured value* must be activated under the general settings, and the parameters must be visible in the ETS.

'Limiting value 1 activated' or 'Limiting values 1 and 2 activated' is set for the *measured value*.

- Select '*Measured value* limiting value 1' or '*Measured value* limiting value 2'.
- In the item 'Sending of limiting value n for value change', select 'Yes'
The value is sent when there is a state change from '0' to '1' or from '1' to '0'.

i The object value is sent again if the limiting value even occurs again, even if the reversed event is parametrized to 'No telegr.'

Setting sending of a limiting value of the precipitation sensor when there is a change

Because the precipitation only has the states 'Precipitation' and 'No precipitation', its states are sent via the two limiting value objects

'Precipitation' must be activated under the general settings, and the parameters must be visible in the ETS.

'Limiting value 1 activated' or 'Limiting values 1 and 2 activated' is set for the 'Precipitation'.

- Select 'Precipitation limiting value 1' or 'Precipitation limiting value 2'.
- In the item 'Sending of limiting value n for value change', select 'Yes'
The limiting value is sent when there is a state change from '0' to '1' or from '1' to '0'.

i If the heating voltage monitoring is parametrized and the proper 24V voltage supply is not present at the input of the weather station, then the object is fixed to 'Precipitation' and sent twice.

Cyclic sending of the limiting values

All limiting value objects of the sensors, including those of the precipitation sensor, can be sent cyclically using the parameter 'cycl. sending of limiting value n '. If in the limiting value activation a combination with 'no telegr.' is set, then the corresponding object value is still sent cyclically via the limiting value object when there is a change.

i Limiting value telegrams 'Sending of limiting value n for value change' that are generated have no effect on the cycle time for the cyclic sending of limiting value objects.

Setting cyclic sending of a limiting value

The sensor for which the limiting value is to be set must be 'Activated' under the parameter page 'General'

On the parameter page of the sensor, for example 'Twilight', the desired 'Limiting value n activated' is set

- For the parameter 'cycl. sending of limiting value n ', select a value between 0 and 120

i The value range to be set is from 0 to 120. This value has to be multiplied by 10 seconds to obtain the cycle time.

i '0' means that the limiting value is not sent cyclically.

The limiting value is sent at the set interval.

4.2.4.3 Logic operations and blocking elements

Logic gates

In order to implement logical dependencies from external states as well, or to cascade weather stations, the device software has six logic gates. Each gate can have from one to a maximum of four inputs. For each logic gate the type of operation 'AND', 'OR', 'exclusive OR', 'AND with return' can be set. In addition, each input and the output can be operated normally or inverted.

For more complex functions it is possible to combine a number of logic gates. Feedback, i.e. connecting an output with an input of the same gate (poss. also via other logic gates or blocking modules) is not prevented by the configuration software. This does not interfere with the other device functions.

- i** Because feedback can lead to a very large number of telegrams, reasonable switch-on or switch-off delays should be set in such cases.
- i** As a rule, a logic operation is only evaluated when an input telegram is received. If a feedback with a cyclically sending output is created, it may occur that the device will send telegrams independently after the application is loaded or after a reset. In this case, too, switch-on or switch-off delays are highly advisable.
- i** With an 'AND with return' the value of the input is fed back internally to input 1. The result of this is that the output can only have the value '1' again if input 1 is set to '1' after the value '1' is already present on all of the other inputs. As soon as one of the other inputs receives the value '0', the output and thus also input 1 are set to '0' because of the feedback.

Example: A light that is switched on manually only when twilight comes, and should be switched off again automatically at daybreak. Here the push-button is connected with input 1 and the limiting value of the twilight sensor is connected with input 2. After the twilight sensor has set input 2 to '1', the pushbutton can be used to switch on the light at input 1. If the light is not switched off manually, at daybreak the feedback ensures that input 1 is also reset internally to '0'. Without this feedback the light would be switched on again automatically at the next time twilight.

Parametrizing logic gates

The following settings must be made in order to use a logic gate:

- Activate the required number of 'Logic gates' (max. six) in the configuration window 'General'.

In the configuration window 'Logic gate *n*':

- Select the type of logic operation.
- In parameter 'Send output when', select under what precondition the output object should be sent.
- In the parameter 'Number of inputs', select a number of inputs between 1 and 4.
- Set the parameter 'Output response' to 'Normal' or 'Inverted'.
- Set the 'Switch-on delay'.
- Set the 'Switch-off delay'.
- i** When using the delays, ensure that the time delays can be retriggered. Thus, with a switch-on delay, a "1" telegram at the gate input always causes the time delay to be restarted. A "0" status at a gate output retriggers the run-on time each time. In consequence, input states are first evaluated and output states are only transmitted to the bus as a telegram when the time delays have elapsed completely.
This should be observed particularly when input states are sent cyclically to the gate. If there is a combination of cyclical transmission and time delays, the time delays should always be set to smaller than the cyclical transmission.
- In parameter 'Cyclic sending of the output', set whether, and if so at what time interval the output object should be sent.

In the configuration window 'Logic gate *n* inputs' set the following for all of the selected inputs:

- Under 'Input *n*', define whether an internal or an external input value should be assigned.

- Define the response 'Input n ' with 'Normal' or 'Inverted'.
- If an 'Internal input value' has been selected for the input in question, select the desired value from the list of all internal 1 bit values.

The logic gate has been completely parameterised.

Example of a logic gate configuration for awning protection

When controlling awnings, rain and wind monitoring is often required. If it rains, or the wind exceeds a certain limiting value, then the awning should be retracted after a short waiting time. This function can be implemented using a simple logic gate.

Limiting values for precipitation and wind are configured in the ETS. The limiting values may not be transmitted cyclically.

At least 1 logic gate must be configured.

- Select a free activated gate simply by clicking on it.
- Select the 'Type of logic operation': 'OR'.
- Select 'Send output at': 'Every input event'.
- Select 'Number of inputs': '2 inputs'.
- Select 'Response of output': 'Normal'.
- Select 'Switch-on delay': 'No delay'.
- Select 'Switch-off delay': 'Delay on'. Set the required run-on time (for example: '5 minutes').
- Select 'Cyclic sending of the output', for example '120 s', to increase transmission security.
- Select 'Logic gate n inputs' simply by clicking the parameter node.
- Select 'Input 1': 'Internal input value'.
- Select 'Response input 1': 'Normal'.
- Select 'Assign input 1': 'Precipitation LV n '.
- Select 'Input 2': 'Internal input value'.
- Select 'Response input 2': 'Normal'.
- Select 'Assign input 2': 'Wind LV n '
- Connect the output of the logic gate (communication object) with a group address. Link this group address to a security input of the awning actuator. Assign the security input in the actuator to the appropriate output (refer to the documentation of the actuator for additional information).

The activation deactivation of the awning protection responds according to the following logic.

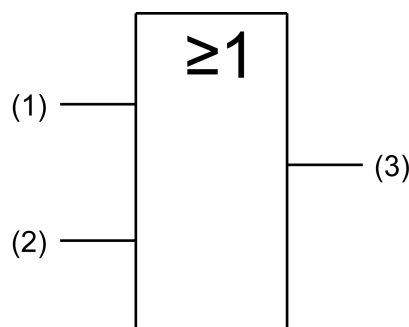

Figure 18: Activation / deactivation of awning protection

- (1) Limiting value n precipitation
- (2) Limiting value n wind

(3) Output logic gate n for activation / deactivation of the awning protection.

- i** If the KNX/EIB system requires that the limiting values for precipitation and wind are transmitted cyclically to the bus, as in the above example, then an additional two logic gates must be enabled in the ETS. These additional gates (OR, 1 input) must then be assigned separately on the input side to the limiting values and transmit the output state cyclically to the bus. Optionally, switch-on delays and run-on times can be configured here.
- i** Refer to the application-orientated function description in this documentation for additional applications and combination options of logic functions to protect exterior systems against weathering influences (see page 25).

Blocking elements

In order to be able to suppress the automatic control of functions by measured values, limiting values or other outputs of the weather station, four blocking modules are integrated into the software. These blocking modules consist of an input object, an output object and a blocking object. They function like a gate that is either open or closed. Depending on the value of the blocking object, the value of the input object is either forwarded unchanged to the output object (gate open), or the channel is closed (gate closed). If during a block the value of the input is changed, the output sends this value as soon as the block is removed. The blocking object itself is a 1-bit communications object, whose response (block when 0, block when 1) and state can be set during initialisation.

Parametrizing blocking elements

To allow a blocking module to be used, the following settings must be made.

In the configuration window 'General':

- Activate the required number of 'Blocking modules' (max. four).

In the configuration window 'Blocking module n ':

- Define the 'Response of blocking object' with blocking for a 0 telegram or blocking for a 1 telegram.
- In parameter 'Blocking response upon initialization', select 'Enabled' or 'Blocked'
- Determine the type input/output. This can be of the type 'Switching 1 bit', 'Value 2 bytes' or 'Rel. value 1 byte'.
- Under 'Input', define whether an internal or an external input value should be assigned
- If an 'Internal input value' has been selected for the input in question, then depending on the setting for the parameter 'Type of input/output', select the desired internal value from the list of all internal 1 bit or 2 byte values. No internal relative values are present in the weather station.

The blocking element is now set.

4.2.4.4 Condition as shipped

In the weather station's state as delivered, the application program is unloaded. No feedback is made to the bus. The device can be programmed and put into operation via the ETS. The physical address is preset to 15.15.255.

4.2.5 Parameter

Description	Values	Comment
 General		
Blocking modules	No blocking module 1 blocking module 2 blocking modules 3 blocking modules 4 blocking modules	Select here whether and how many blocking modules should be used. i Blocking modules that are not used will not be displayed in the ETS!
Logic gate	No logic gate 1 logic gate 2 logic gates 3 logic gates 4 logic gates 5 logic gates 6 logic gates	Select here whether and how many logic gates should be used. i Logic gates that are not used will not be displayed in the ETS!
Brightness sensor 1	not activated activated	Select here whether you wish to use brightness sensor 1. i Sensors that are not activated will not be displayed in the ETS!
Brightness sensor 2	not activated activated	Select here whether you wish to use brightness sensor 2. i Sensors that are not activated will not be displayed in the ETS!
Brightness sensor 3	not activated activated	Select here whether you wish to use brightness sensor 3. i Sensors that are not activated will not be displayed in the ETS!
Twilight sensor	not activated activated	Select here whether you want to use the twilight sensor. i Sensors that are not activated will not be displayed in the ETS!
Wind sensor	not activated activated	Select here whether you want to use the wind sensor. i Sensors that are not activated will not be displayed in the ETS!
Precipitation	not activated activated	Select here whether you want to use the precipitation sensor. i Sensors that are not activated will not be displayed in the ETS!
Temperature sensor	not activated activated	Select here whether you want to use the temperature sensor. i Sensors that are not activated will not be displayed in the ETS!
Max. brightness sensor 1-3	not activated activated	Activate this parameter if you do not need direction-specific brightness. i If this function is set to "Not activated", it will not be displayed in the ETS!
Max. brightness sensor 1-3 and twilight	not activated activated	Activate this parameter if you do not need direction-specific brightness, but you do need increased precision in the

lower value range (twilight). When the brightness drops below 1000 lux, the twilight value is output. Because the measuring range of the twilight sensor ends at 674 lux, jumps are possible in this range.

i If this function is set to "Not activated", it will not be displayed in the ETS!

 Brightness sensor n (n = number of the sensor / Only visible if the parameter 'Brightness sensor n ' under 'General' is set to 'Activated!')
(Measuring range 0...110,000 lux)

Limiting values	not activated Limiting value 1 activated Limiting values 1 and 2 activated	Select here whether this sensor should have limiting values, and how many. i Limiting values that are not activated will not be displayed!
Send measured value at (10s sending delay)	0.5% measured value difference 1% measured value difference 3% Measured value difference 10% measured value difference	So as not to burden the bus with very frequent telegrams, the measured value should not be sent for every tiny change. As large a value as possible should be set here, taking the measurement task into account. i The percentage specification for the measured value difference is always relative to the measuring range upper range value! i A fixed sending delay of 10 seconds is set.
cycl. sending of the measured value (x 10s)	0...120	Set here whether and at what time interval the value is sent. The set value multiplied by 10 is the repeat time in seconds. It is thus possible to set the cycle time in steps of 10 seconds. The value "0" means that no cyclic sending is carried out. i The cyclic telegrams sent via this setting are independent of the telegrams that result from the setting "Send measured value when ... measured value difference.

 Brightness sensor n limiting value 1 (n = number of the sensor / Brightness sensor n (n Only visible if the parameter 'Brightness sensor n ' under 'General' is set to 'Activated' and the parameter 'Limiting values' is set here to 'Limiting value 1 activated' or to 'Limiting values 1 and 2 activated!')

Limiting value 1 in klx	3 klx 5 klx 10 klx 15 klx 20 klx 25 klx 30 klx 35 klx 40 klx 45 klx 50 klx 55 klx 60 klx	Set here the threshold for the limiting value in the range from 3 klx to 105 klx. i In conjunction with the parameters "Limiting value 1" and "Hysteresis limiting value 1", define the thresholds at which the limiting value object is set to "1" or "0" when they are exceeded or undershot.
-------------------------	---	---



	65 klx 70klx 75 klx 80 klx 85 klx 90 klx 95 klx 100klx 105 klx	
Hysteresis limiting value 1 in klx	No hysteresis 1 klx 2 klx 3 klx 4 klx 5 klx 10 klx 20 klx 30 klx 40 klx 50 klx 60 klx 70 klx 80 klx 90 klx 100 klx	Set here the hysteresis in the range from no hysteresis to 100 klx. i In conjunction with the parameters "Limiting value 1" and "Hysteresis limiting value 1", define the thresholds at which the limiting value object is set to "1" or "0" when they are exceeded or undershot.
Activation limiting value 1 LV=limiting value, hyst.=hysteresis	Exceed LV = ON, Undershoot LV-Hyst. = OFF Exceed LV = OFF, Undershoot LV-Hyst. = ON Undershoot LV = ON, Exceed LV+Hyst.= OFF Undershoot LV = OFF, Exceed LV+Hyst. = ON Exceed LV = ON, Undershoot LV-Hyst. = no telegr. Exceed LV = OFF, Undershoot LV-Hyst. = no telegr. Undershoot LV = ON, Exceed LV+Hyst. = no telegr. Undershoot LV = OFF, Exceed LV+Hyst. = no telegr. Exceed LV = no telegr., Undershoot LV-Hyst. = OFF Exceed LV = no telegr., Undershot LV-Hyst. = ON	Set here which action should be carried if the limiting value is crossed from a specifically defined direction. i In conjunction with the parameters "Limiting value 1" and "Hysteresis limiting value 1", define the thresholds at which the limiting value object is set to "1" or "0" when they are exceeded or undershot.

	Undershoot LV = no telegr., Exceed LV+Hyst. = OFF	
	Undershoot LV = no telegr., Exceed LV+Hyst. = ON	
External limiting value 1	No	No external limiting value 1 is parametrized
	16 bit value	The limiting value is specified by an external device via a 2 byte value object.
	8 bit value	The limiting value is specified by an external device via a 1 byte value object.
	Save limiting value via switching object (teaching)	When this external switching object is used it is possible, e.g. by pressing a pushbutton, to define the measured value of the sensor at that moment as a limiting value.
		<p>i Using an external object, the user of the building can set the limiting value to suit his needs without having to change the parametrization.</p> <p>i When a download is carried out, the external values are overwritten with the ETS data. Only when a value is received again after a download will that value be processed again.</p>
Switch-on delay limiting value 1	No delay 1s delay 3s delay 5s delay 10s delay 15s delay 30s delay 1min delay 3min delay 5min delay 10min delay 15min delay 30min delay 60min delay	Only after the time set here will the current state of the limiting value be accepted in the limiting value object. This means that <ul style="list-style-type: none"> - a change in the limiting value to "1" will only be sent after this time elapses; - in the case of cyclic sending the limiting value of the changed value "1" is only sent after this time expires. Thus while the timer for the delay time is running, a "0" continues to be sent. <p>i If the parameter "Activation limiting value" for a condition is set to "No telegram", then the cyclic telegrams are also suppressed when the set condition is fulfilled.</p>
Switch-off delay limiting value 1	No delay 1s delay 3s delay 5s delay 10s delay 15s delay 30s delay 1min delay 3min delay 5min delay 10min delay 15min delay 30min delay 60min delay	Only after the time set here is the current state of the limiting value applied to the limiting value object. This means that <ul style="list-style-type: none"> - a change of the limiting value to the value "0" is only sent after this time elapses, - with cyclic sending of the limiting value the changed value "0" is only sent after this time elapses. Therefore a "1" continues to be sent while the timer for the delay time is running.

Sending of limiting value 1 for value change	No	<p>i If the parameter "Activation limiting value" for a condition is set to "No telegram", then the cyclic telegrams are also suppressed when the set condition is fulfilled.</p>
	Yes	<p>The limiting value object is not sent when there is a change. If the parameter "Cyclic sending of the limiting value" is set to at least 1, then the limiting value object is sent cyclically regardless of any change.</p> <p>The limiting value object is sent when there is a change from "0" to "1" or a change from "1" to "0".</p>
Cycl. sending of the limiting value 1 (x 10s)	0...120	<p>i If this parameter "Sending of limiting value for value change" is set to "No" and the parameter "Cyclic sending of the limiting value" is set to "0", then the limiting value is not sent at all.</p> <p>Set here whether and at what time interval the limiting value is sent. The set value multiplied by 10 is the repeat time in seconds. It is thus possible to set the cycle time in steps of 10 seconds. The value "0" means that the limiting value object is not sent cyclically.</p>
		<p>i If the parameter "Sending of limiting value for value change" is set to "No" and this parameter "Cyclic sending of the limiting value" is set to "0", then the limiting value is not sent at all.</p>
<p> Brightness sensor <i>n</i> limiting value 2 (<i>n</i> = Number of the sensor / Only visible if the parameter 'Brightness sensor <i>n</i>' under 'General' is set to 'Activated' and the parameter 'Limiting values' is set here to 'Limiting values 1 and 2 activated!')</p>		
Limiting value 2 in klx	<p>3 klx 5 klx 10 klx 15 klx 20 klx 25 klx 30 klx 35 klx 40 klx 45 klx 50 klx 55 klx 60 klx 65 klx 70 klx 75 klx 80 klx 85 klx 90 klx 95 klx 100 klx 105 klx</p>	<p>Set here the threshold for the limiting value in the range from 3 klx to 105 klx.</p> <p>i In conjunction with the parameters "Limiting value 2" and "Hysteresis limiting value 2", define the thresholds at which the limiting value object is set to "1" or "0" when they are exceeded or undershot.</p>

<p>Hysteresis limiting value 2 in klx</p>	<p>No hysteresis 1 klx 2 klx 3 klx 4 klx 5 klx 10 klx 20 klx 30 klx 40 klx 50 klx 60 klx 70 klx 80 klx 90 klx 100 klx</p>	<p>Set here the hysteresis in the range from no hysteresis to 100 klx.</p> <p>i In conjunction with the parameters "Limiting value 2" and "Hysteresis limiting value 2", define the thresholds at which the limiting value object is set to "1" or "0" when they are exceeded or undershot.</p>
<p>Activation limiting value 2 LV=limiting value, Hyst.=Hysteresis</p>	<p>Exceed LV = ON, Undershoot LV-Hyst. = OFF</p> <p>Exceed LV = OFF, Undershoot LV-Hyst. = ON</p> <p>Undershoot LV = ON, Exceed LV+Hystr.= OFF</p> <p>Undershoot LV = OFF, Exceed LV+Hyst. = ON</p> <p>Exceed LV = ON, Undershoot LV-Hyst. = no telegr.</p> <p>Exceed LV = OFF, Undershoot LV-Hyst. = no telegr.</p> <p>Undershoot LV = ON, Exceed LV+Hyst. = no telegr.</p> <p>Undershoot LV = OFF, Exceed LV+Hyst. = no telegr.</p> <p>Exceed LV = no telegr., Undershoot LV-Hyst. = OFF</p> <p>Exceed LV = no telegr., Undershot LV-Hyst. = ON</p> <p>Undershoot LV = no telegr., Exceed LV+Hyst. = OFF</p> <p>Undershoot LV = no telegr., Exceed LV+Hyst. = ON</p>	<p>Set here which action should be carried if the limiting value is crossed from a specifically defined direction.</p> <p>i In conjunction with the parameters "Limiting value 2" and "Hysteresis limiting value 2", define the thresholds at which the limiting value object is set to "1" or "0" when they are exceeded or undershot.</p>
<p>External limiting value 2</p>	<p>No</p> <p>16 bit value</p>	<p>No external limiting value 2 is parametrized</p> <p>The limiting value is specified by an external device via a 2 byte value object.</p>

	8 bit value	The limiting value is specified by an external device via a 1 byte value object.
	Save limiting value via switching object (teaching)	When this external switching object is used it is possible, e.g. by pressing a pushbutton, to define the measured value of the sensor at that moment as a limiting value.
		<p>i Using an external object, the user of the building can set the limiting value to suit his needs without having to change the parametrization.</p>
		<p>i When a download is carried out, the external values are overwritten with the ETS data. Only when a value is received again after a download will that value be processed again.</p>
Switch-on delay limiting value 2	No delay 1s delay 3s delay 5s delay 10s delay 15s delay 30s delay 1min delay 3min delay 5min delay 10min delay 15min delay 30min delay 60min delay	<p>Only after the time set here will the current state of the limiting value be accepted in the limiting value object. This means that</p> <ul style="list-style-type: none"> - a change in the limiting value to "1" will only be sent after this time elapses; - in the case of cyclic sending the limiting value of the changed value "1" is only sent after this time expires. Thus while the timer for the delay time is running, a "0" continues to be sent. <p>i If the parameter "Activation limiting value" for a condition is set to "No telegram", then the cyclic telegrams are also suppressed when the set condition is fulfilled.</p>
Switch-off delay limiting value 2	No delay 1s delay 3s delay 5s delay 10s delay 15s delay 30s delay 1min delay 3min delay 5min delay 10min delay 15min delay 30min delay 60min delay	<p>Only after the time set here is the current state of the limiting value applied to the limiting value object. This means that</p> <ul style="list-style-type: none"> - a change of the limiting value to the value "0" is only sent after this time elapses, - with cyclic sending of the limiting value the changed value "0" is only sent after this time elapses. Therefore a "1" continues to be sent while the timer for the delay time is running. <p>i If the parameter "Activation limiting value" for a condition is set to "No telegram", then the cyclic telegrams are also suppressed when the set condition is fulfilled.</p>
Sending of limiting value 2 for value change	No	<p>The limiting value object is not sent when there is a change.</p> <p>If the parameter "Cyclic sending of the limiting value" is set to at least 1, then the limiting value object is sent cyclically regardless of any change.</p>
	Yes	

		<p>The limiting value object is sent when there is a change from "0" to "1" or a change from "1" to "0".</p> <p>i If this parameter "Sending of limiting value for value change" is set to "No" and the parameter "Cyclic sending of the limiting value" is set to "0", then the limiting value is not sent at all.</p>
Cycl. sending of the limiting value 2 (x10s)	0...120	<p>Set here whether and at what time interval the limiting value is sent. The set value multiplied by 10 is the repeat time in seconds. It is thus possible to set the cycle time in steps of 10 seconds. The value "0" means that the limiting value object is not sent cyclically.</p> <p>i If the parameter "Sending of limiting value for value change" is set to "No" and this parameter "Cyclic sending of the limiting value" is set to "0", then the limiting value is not sent at all.</p>
<p> Max. brightness sensors 1-3 and Max. brightness sensors 1-3 and twilight</p> <p>Parameters see brightness sensor <i>n</i></p> <p> Twilight (Only visible if the parameter 'Twilight' under 'General' is set to 'Activated'!) (Measuring range 0...674 lux)</p>		
Limiting values	<p>not activated</p> <p>Limiting value 1 activated</p> <p>Limiting values 1 and 2 activated</p>	<p>Select here whether this sensor should have limiting values, and how many.</p> <p>i Limiting values that are not activated will not be displayed!</p>
Send measured value at (10s sending delay)	<p>0.5% measured value difference</p> <p>1% measured value difference</p> <p>3% Measured value difference</p> <p>10% measured value difference</p>	<p>So as not to burden the bus with very frequent telegrams, the measured value should not be sent for every tiny change. As large a value as possible should be set here, taking the measurement task into account.</p> <p>i The percentage specification for the measured value difference is always relative to the measuring range upper range value!</p> <p>i A fixed sending delay of 10 seconds is set.</p>
cycl. sending of the measured value (x 10s)	0...120	<p>Set here whether and at what time interval the value is sent. The set value multiplied by 10 is the repeat time in seconds. It is thus possible to set the cycle time in steps of 10 seconds. The value "0" means that no cyclic sending is carried out.</p> <p>i The cyclic telegrams sent via this setting are independent of the telegrams that result from the setting "Send measured value when ... measured value difference.</p>

 Twilight limiting value 1 (Only visible if the parameter 'Twilight' under 'General' is set to 'Activated' and the parameter 'Limiting values' is set here to 'Limiting value 1 activated' or to 'Limiting values 1 and 2 activated'!)

Limiting value 1 in lux

10 lux
 25 lux
 50 lux
 75 lux
 100 lux
 125 lux
 150 lux
 175 lux
 200 lux
 225 lux
 250 lux
 275 lux
 300 lux
 325 lux
 350 lux
 375 lux
 400 lux
 425 lux
 450 lux
 475 lux
 500 lux
 525 lux
 550 lux
 575 lux
 600 lux
 625 lux
 650 lux

Set here the threshold for the limiting value in the range from 1 lux to 650 lux.

 In conjunction with the parameters "Limiting value 1" and "Hysteresis limiting value 1", define the thresholds at which the limiting value object is set to "1" or "0" when they are exceeded or undershot.

Hysteresis limiting value 2 in lux

No hysteresis
 5 lux
 10 lux
25 lux
 50 lux
 100 lux
 150 lux
 200 lux
 250 lux
 300 lux
 350 lux
 400 lux
 450 lux
 500 lux
 550 lux
 600 lux

Set here the hysteresis in the range from no hysteresis to 600 lux.

 In conjunction with the parameters "Limiting value 2" and "Activation of limiting value 2", define the thresholds at which the limiting value object is set to "1" or "0" when they are exceeded or undershot.

Activation limiting value 1
 LV=limiting value,
 hyst.=hysteresis

**Exceed LV = ON,
 Undershoot LV-Hyst. =
 OFF**

Set here which action should be carried if the limiting value is crossed from a specifically defined direction.

Exceed LV = OFF,
 Undershoot LV-Hyst. = ON

 In conjunction with the parameters "Limiting value 1" and "Hysteresis limiting value 1", define the thresholds at which the limiting value object is set to "1" or "0" when they are exceeded or undershot.

Undershoot LV = ON,
 Exceed LV+Hystr.= OFF

Undershoot LV = OFF,
 Exceed LV+Hyst. = ON

Exceed LV = ON,

	Undershoot LV-Hyst. = no telegr.	
	Exceed LV = OFF, Undershoot LV-Hyst. = no telegr.	
	Undershoot LV = ON, Exceed LV+Hyst. = no telegr.	
	Undershoot LV = OFF, Exceed LV+Hyst. = no telegr.	
	Exceed LV = no telegr., Undershoot LV-Hyst. = OFF	
	Exceed LV = no telegr., Undershot LV-Hyst. = ON	
	Undershoot LV = no telegr., Exceed LV+Hyst. = OFF	
	Undershoot LV = no telegr., Exceed LV+Hyst. = ON	
External limiting value 1	No	No external limiting value 1 is parametrized
	16 bit value	The limiting value is specified by an external device via a 2 byte value object.
	8 bit value	The limiting value is specified by an external device via a 1 byte value object.
	Save limiting value via switching object (teaching)	When this external switching object is used it is possible, e.g. by pressing a pushbutton, to define the measured value of the sensor at that moment as a limiting value.
		<p>i Using an external object, the user of the building can set the limiting value to suit his needs without having to change the parametrization.</p> <p>i When a download is carried out, the external values are overwritten with the ETS data. Only when a value is received again after a download will that value be processed again.</p>
Switch-on delay limiting value 1	No delay 1s delay 3s delay 5s delay 10s delay 15s delay 30s delay 1min delay 3min delay 5min delay 10min delay	Only after the time set here will the current state of the limiting value be accepted in the limiting value object. This means that a change in the limiting value to "1" will only be sent after this time elapses; in the case of cyclic sending the limiting value of the changed value "1" is only sent after this time expires. Thus while the timer for the delay time is running, a "0" continues to be sent.

	15min delay 30min delay 60min delay	<p>i If the parameter "Activation limiting value" for a condition is set to "No telegram", then the cyclic telegrams are also suppressed when the set condition is fulfilled.</p>
Switch-off delay limiting value 1	No delay 1s delay 3s delay 5s delay 10s delay 15s delay 30s delay 1min delay 3min delay 5min delay 10min delay 15min delay 30min delay 60min delay	<p>Only after the time set here is the current state of the limiting value applied to the limiting value object. This means that</p> <ul style="list-style-type: none"> - a change of the limiting value to the value "0" is only sent after this time elapses, - with cyclic sending of the limiting value the changed value "0" is only sent after this time elapses. Therefore a "1" continues to be sent while the timer for the delay time is running. <p>i If the parameter "Activation limiting value" for a condition is set to "No telegram", then the cyclic telegrams are also suppressed when the set condition is fulfilled.</p>
Sending of limiting value 1 for value change	No	<p>The limiting value object is not sent when there is a change. If the parameter "Cyclic sending of the limiting value" is set to at least 1, then the limiting value object is sent cyclically regardless of any change.</p>
	Yes	<p>The limiting value object is sent when there is a change from "0" to "1" or a change from "1" to "0".</p> <p>i If this parameter "Sending of limiting value for value change" is set to "No" and the parameter "Cyclic sending of the limiting value" is set to "0", then the limiting value is not sent at all.</p>
Cycl. sending of the limiting value 1 (x 10s)	0...120	<p>Set here whether and at what time interval the limiting value is sent. The set value multiplied by 10 is the repeat time in seconds. It is thus possible to set the cycle time in steps of 10 seconds. The value "0" means that the limiting value object is not sent cyclically.</p> <p>i If the parameter "Sending of limiting value for value change" is set to "No" and this parameter "Cyclic sending of the limiting value" is set to "0", then the limiting value is not sent at all.</p>
<p> Twilight limiting value 2 (Only visible if the parameter 'Twilight' under 'General' is set to 'Activated' and the parameter 'Limiting values' is set here to 'Limiting values 1 and 2 activated!')</p>		
Limiting value 2 in lux	10 lux 25 lux 50 lux 75 lux 100 lux 125 lux	<p>Set here the threshold for the limiting value in the range from 1 lux to 650 lux.</p>

	<p>150 lux 175 lux 200 lux 225 lux 250 lux 275 lux 300 lux 325 lux 350 lux 375 lux 400 lux 425 lux 450 lux 475 lux 500 lux 525 lux 550 lux 575 lux 600 lux 625 lux 650 lux</p>	<p>i In conjunction with the parameters "Limiting value 2" and "Hysteresis limiting value 2", define the thresholds at which the limiting value object is set to "1" or "0" when they are exceeded or undershot.</p>
<p>Hysteresis limiting value 2 in lux</p>	<p>No hysteresis 5 lux 10 lux 25 lux 50 lux 100 lux 150 lux 200 lux 250 lux 300 lux 350 lux 400 lux 450 lux 500 lux 550 lux 600 lux</p>	<p>Set here the hysteresis in the range from no hysteresis to 600 lux.</p> <p>i In conjunction with the parameters "Limiting value 2" and "Activation of limiting value 2", define the thresholds at which the limiting value object is set to "1" or "0" when they are exceeded or undershot.</p>
<p>Activation limiting value 2 LV=limiting value, Hyst.=Hysteresis</p>	<p>Exceed LV = ON, Undershoot LV-Hyst. = OFF</p> <p>Exceed LV = OFF, Undershoot LV-Hyst. = ON</p> <p>Undershoot LV = ON, Exceed LV+Hystr.= OFF</p> <p>Undershoot LV = OFF, Exceed LV+Hyst. = ON</p> <p>Exceed LV = ON, Undershoot LV-Hyst. = no telegr.</p> <p>Exceed LV = OFF, Undershoot LV-Hyst. = no telegr.</p> <p>Undershoot LV = ON, Exceed LV+Hyst. =</p>	<p>Set here which action should be carried if the limiting value is crossed from a specifically defined direction.</p> <p>i In conjunction with the parameters "Limiting value 2" and "Hysteresis limiting value 2", define the thresholds at which the limiting value object is set to "1" or "0" when they are exceeded or undershot.</p>

	no telegr.	
	Undershoot LV = OFF, Exceed LV+Hyst. = no telegr.	
	Exceed LV = no telegr., Undershoot LV-Hyst. = OFF	
	Exceed LV = no telegr., Undershot LV-Hyst. = ON	
	Undershoot LV = no telegr., Exceed LV+Hyst. = OFF	
	Undershoot LV = no telegr., Exceed LV+Hyst. = ON	
External limiting value 2	No	No external limiting value 2 is parametrized
	16 bit value	The limiting value is specified by an external device via a 2 byte value object.
	8 bit value	The limiting value is specified by an external device via a 1 byte value object.
	Save limiting value via switching object (teaching)	When this external switching object is used it is possible, e.g. by pressing a pushbutton, to define the measured value of the sensor at that moment as a limiting value. <i>i</i> Using an external object, the user of the building can set the limiting value to suit his needs without having to change the parametrization. <i>i</i> When a download is carried out, the external values are overwritten with the ETS data. Only when a value is received again after a download will that value be processed again.
Switch-on delay limiting value 2	No delay 1s delay 3s delay 5s delay 10s delay 15s delay 30s delay 1min delay 3min delay 5min delay 10min delay 15min delay 30min delay 60min delay	Only after the time set here will the current state of the limiting value be accepted in the limiting value object. This means that a change in the limiting value to "1" will only be sent after this time elapses; in the case of cyclic sending the limiting value of the changed value "1" is only sent after this time expires. Thus while the timer for the delay time is running, a "0" continues to be sent. <i>i</i> If the parameter "Activation limiting value" for a condition is set to "No telegram", then the cyclic telegrams are also suppressed when the set condition is fulfilled.
Switch-off delay limiting value 2	No delay 1s delay 3s delay	Only after the time set here is the current state of the limiting value applied to the limiting value object. This means

	<p>5s delay 10s delay 15s delay 30s delay 1min delay 3min delay 5min delay 10min delay 15min delay 30min delay 60min delay</p>	<p>that - a change of the limiting value to the value "0" is only sent after this time elapses, - with cyclic sending of the limiting value the changed value "0" is only sent after this time elapses. Therefore a "1" continues to be sent while the timer for the delay time is running.</p> <p>i If the parameter "Activation limiting value" for a condition is set to "No telegram", then the cyclic telegrams are also suppressed when the set condition is fulfilled.</p>
<p>Sending of limiting value 2 for value change</p>	<p>No</p> <p>Yes</p>	<p>The limiting value object is not sent when there is a change. If the parameter "Cyclic sending of the limiting value" is set to at least 1, then the limiting value object is sent cyclically regardless of any change.</p> <p>The limiting value object is sent when there is a change from "0" to "1" or a change from "1" to "0".</p> <p>i If this parameter "Sending of limiting value for value change" is set to "No" and the parameter "Cyclic sending of the limiting value" is set to "0", then the limiting value is not sent at all.</p>
<p>Cycl. sending of the limiting value 2 (x10s)</p>	<p>0...120</p>	<p>Set here whether and at what time interval the limiting value is sent. The set value multiplied by 10 is the repeat time in seconds. It is thus possible to set the cycle time in steps of 10 seconds. The value "0" means that the limiting value object is not sent cyclically.</p> <p>i If the parameter "Sending of limiting value for value change" is set to "No" and this parameter "Cyclic sending of the limiting value" is set to "0", then the limiting value is not sent at all.</p>
<p> Wind sensor (Only visible if the parameter 'Wind sensor' under 'General' is set to 'activated') (Measuring range 1...40 m/s)</p>		
<p>Limiting values</p>	<p>not activated Limiting value 1 activated Limiting values 1 and 2 activated</p>	<p>Select here whether this sensor should have limiting values, and how many.</p> <p>i Limiting values that are not activated will not be displayed!</p>
<p>Send measured value at (10s sending delay)</p>	<p>0.5% measured value difference 1% measured value difference 3% Measured value difference 10% measured value difference</p>	<p>So as not to burden the bus with very frequent telegrams, the measured value should not be sent for every tiny change. As large a value as possible should be set here, taking the measurement task into account.</p>



cycl. sending of the measured value (x 10s)	0...120	<p>i The percentage specification for the measured value difference is always relative to the measuring range upper range value!</p> <p>i A fixed sending delay of 10 seconds is set.</p> <p>Set here whether and at what time interval the value is sent. The set value multiplied by 10 is the repeat time in seconds. It is thus possible to set the cycle time in steps of 10 seconds. The value "0" means that no cyclic sending is carried out.</p> <p>i The cyclic telegrams sent via this setting are independent of the telegrams that result from the setting "Send measured value when ... measured value difference.</p>
<p> Wind sensor limiting value 1 (Only visible if the parameter 'Wind sensor' under 'General' is set to 'Activated' and the parameter 'Limiting values' is set here to 'Limiting value 1 activated' or to 'Limiting values 1 and 2 activated'!)</p>		
Limiting value 1 in m/s	<p>1 m/s (wind strength 1) 3 m/s (wind strength 2) 5 m/s (wind strength 3) 8 m/s (wind strength 4) 10 m/s (wind strength 5) 12 m/s (wind strength 6) 15 m/s (wind strength 7) 20 m/s (wind strength 8) 22 m/s (wind strength 9) 25 m/s (wind strength 10) 30 m/s (wind strength 11) 35 m/s (wind strength 12)</p>	<p>Set here the threshold for the limiting value in the range from 1 ms to 35 m/s.</p> <p>i In conjunction with the parameters "Limiting value 1" and "Hysteresis limiting value 1", define the thresholds at which the limiting value object is set to "1" or "0" when they are exceeded or undershot.</p>
Hysteresis limiting value 1 in m/s	<p>1 m/s 3 m/s 5 m/s 8 m/s 10 m/s</p>	<p>Set here the hysteresis in the range from no hysteresis to 10 m/s.</p> <p>i In conjunction with the parameters "Limiting value 1" and "Activation of limiting value 1", define the thresholds at which the limiting value object is set to "1" or "0" when they are exceeded or undershot.</p>
Activation limiting value 1 LV=limiting value, hyst.=hysteresis	<p>Exceed LV = ON, Undershoot LV-Hyst. = OFF</p> <p>Exceed LV = OFF, Undershoot LV-Hyst. = ON</p> <p>Undershoot LV = ON, Exceed LV+Hystr. = OFF</p> <p>Undershoot LV = OFF, Exceed LV+Hyst. = ON</p> <p>Exceed LV = ON, Undershoot LV-Hyst. = no telegr.</p>	<p>Set here which action should be carried if the limiting value is crossed from a specifically defined direction.</p> <p>i In conjunction with the parameters "Limiting value 1" and "Hysteresis limiting value 1", define the thresholds at which the limiting value object is set to "1" or "0" when they are exceeded or undershot.</p>

	Exceed LV = OFF, Undershoot LV-Hyst. = no telegr.	
	Undershoot LV = ON, Exceed LV+Hyst. = no telegr.	
	Undershoot LV = OFF, Exceed LV+Hyst. = no telegr.	
	Exceed LV = no telegr., Undershoot LV-Hyst. = OFF	
	Exceed LV = no telegr., Undershot LV-Hyst. = ON	
	Undershoot LV = no telegr., Exceed LV+Hyst. = OFF	
	Undershoot LV = no telegr., Exceed LV+Hyst. = ON	
External limiting value 1	No	No external limiting value 1 is parametrized
	16 bit value	The limiting value is specified by an external device via a 2 byte value object.
	8 bit value	The limiting value is specified by an external device via a 1 byte value object.
	Save limiting value via switching object (teaching)	When this external switching object is used it is possible, e.g. by pressing a pushbutton, to define the measured value of the sensor at that moment as a limiting value.
		<ul style="list-style-type: none"> i Using an external object, the user of the building can set the limiting value to suit his needs without having to change the parametrization. i When a download is carried out, the external values are overwritten with the ETS data. Only when a value is received again after a download will that value be processed again.
Switch-on delay limiting value 1	No delay 1s delay 3s delay 5s delay 10s delay 15s delay 30s delay 1min delay 3min delay 5min delay 10min delay 15min delay 30min delay 60min delay	Only after the time set here will the current state of the limiting value be accepted in the limiting value object. This means that a change in the limiting value to "1" will only be sent after this time elapses; in the case of cyclic sending the limiting value of the changed value "1" is only sent after this time expires. Thus while the timer for the delay time is running, a "0" continues to be sent.

Switch-off delay limiting value 1	<p>No delay 1s delay 3s delay 5s delay 10s delay 15s delay 30s delay 1min delay 3min delay 5min delay 10min delay 15min delay 30min delay 60min delay</p>	<p>i If the parameter "Activation limiting value" for a condition is set to "No telegram", then the cyclic telegrams are also suppressed when the set condition is fulfilled.</p>
Sending of limiting value 1 for value change	<p>No</p>	<p>Only after the time set here is the current state of the limiting value applied to the limiting value object. This means that</p> <ul style="list-style-type: none"> - a change of the limiting value to the value "0" is only sent after this time elapses, - with cyclic sending of the limiting value the changed value "0" is only sent after this time elapses. Therefore a "1" continues to be sent while the timer for the delay time is running.
Sending of limiting value 1 for value change	<p>Yes</p>	<p>i If the parameter "Activation limiting value" for a condition is set to "No telegram", then the cyclic telegrams are also suppressed when the set condition is fulfilled.</p> <p>The limiting value object is not sent when there is a change.</p> <p>If the parameter "Cyclic sending of the limiting value" is set to at least 1, then the limiting value object is sent cyclically regardless of any change.</p> <p>The limiting value object is sent when there is a change from "0" to "1" or a change from "1" to "0".</p> <p>i If this parameter "Sending of limiting value for value change" is set to "No" and the parameter "Cyclic sending of the limiting value" is set to "0", then the limiting value is not sent at all.</p>
Cycl. sending of the limiting value 1 (x 10s)	<p>0...120</p>	<p>Set here whether and at what time interval the limiting value is sent. The set value multiplied by 10 is the repeat time in seconds. It is thus possible to set the cycle time in steps of 10 seconds. The value "0" means that the limiting value object is not sent cyclically.</p> <p>i If the parameter "Sending of limiting value for value change" is set to "No" and this parameter "Cyclic sending of the limiting value" is set to "0", then the limiting value is not sent at all.</p>
<p> Wind sensor limiting value 2 (Only visible if the parameter 'Wind sensor' under 'General' is set to 'Activated' and the parameter 'Limiting values' is set here to 'Limiting values 1 and 2 activated!')</p>		
Limiting value 2 in m/s	<p>1 m/s (wind strength 1) 3 m/s (wind strength 2) 5 m/s (wind strength 3) 8 m/s (wind strength 4) 10 m/s (wind strength 5)</p>	<p>Set here the threshold for the limiting value in the range from 1 ms to 35 m/s.</p>

	<p>12 m/s (wind strength 6) 15 m/s (wind strength 7) 20 m/s (wind strength 8) 22 m/s (wind strength 9) 25 m/s (wind strength 10) 30 m/s (wind strength 11) 35 m/s (wind strength 12)</p>	<p>i In conjunction with the parameters "Limiting value 2" and "Hysteresis limiting value 2", define the thresholds at which the limiting value object is set to "1" or "0" when they are exceeded or undershot.</p>
Hysteresis limiting value 2 in m/s	<p>1 m/s 3 m/s 5 m/s 8 m/s 10 m/s</p>	<p>Set here the hysteresis in the range from no hysteresis to 10 m/s.</p> <p>i In conjunction with the parameters "Limiting value 2" and "Activation of limiting value 2", define the thresholds at which the limiting value object is set to "1" or "0" when they are exceeded or undershot.</p>
Activation limiting value 2 LV=limiting value, Hyst.=Hysteresis	<p>Exceed LV = ON, Undershoot LV-Hyst. = OFF</p> <p>Exceed LV = OFF, Undershoot LV-Hyst. = ON</p> <p>Undershoot LV = ON, Exceed LV+Hystr.= OFF</p> <p>Undershoot LV = OFF, Exceed LV+Hyst. = ON</p> <p>Exceed LV = ON, Undershoot LV-Hyst. = no telegr.</p> <p>Exceed LV = OFF, Undershoot LV-Hyst. = no telegr.</p> <p>Undershoot LV = ON, Exceed LV+Hyst. = no telegr.</p> <p>Undershoot LV = OFF, Exceed LV+Hyst. = no telegr.</p> <p>Exceed LV = no telegr., Undershoot LV-Hyst. = OFF</p> <p>Exceed LV = no telegr., Undershot LV-Hyst. = ON</p> <p>Undershoot LV = no telegr., Exceed LV+Hyst. = OFF</p> <p>Undershoot LV = no telegr., Exceed LV+Hyst. = ON</p>	<p>Set here which action should be carried if the limiting value is crossed from a specifically defined direction.</p> <p>i In conjunction with the parameters "Limiting value 2" and "Hysteresis limiting value 2", define the thresholds at which the limiting value object is set to "1" or "0" when they are exceeded or undershot.</p>
External limiting value 2	<p>No</p> <p>16 bit value</p>	<p>No external limiting value 2 is parametrized</p>

		<p>The limiting value is specified by an external device via a 2 byte value object.</p> <p>The limiting value is specified by an external device via a 1 byte value object.</p> <p>When this external switching object is used it is possible, e.g. by pressing a pushbutton, to define the measured value of the sensor at that moment as a limiting value.</p> <p>i Using an external object, the user of the building can set the limiting value to suit his needs without having to change the parametrization.</p> <p>i When a download is carried out, the external values are overwritten with the ETS data. Only when a value is received again after a download will that value be processed again.</p>
	8 bit value	
	Save limiting value via switching object (teaching)	
Switch-on delay limiting value 2	<p>No delay</p> <p>1s delay</p> <p>3s delay</p> <p>5s delay</p> <p>10s delay</p> <p>15s delay</p> <p>30s delay</p> <p>1min delay</p> <p>3min delay</p> <p>5min delay</p> <p>10min delay</p> <p>15min delay</p> <p>30min delay</p> <p>60min delay</p>	<p>Only after the time set here will the current state of the limiting value be accepted in the limiting value object. This means that</p> <ul style="list-style-type: none"> - a change in the limiting value to "1" will only be sent after this time elapses; - in the case of cyclic sending the limiting value of the changed value "1" is only sent after this time expires. Thus while the timer for the delay time is running, a "0" continues to be sent. <p>i If the parameter "Activation limiting value" for a condition is set to "No telegram", then the cyclic telegrams are also suppressed when the set condition is fulfilled.</p>
Switch-off delay limiting value 2	<p>No delay</p> <p>1s delay</p> <p>3s delay</p> <p>5s delay</p> <p>10s delay</p> <p>15s delay</p> <p>30s delay</p> <p>1min delay</p> <p>3min delay</p> <p>5min delay</p> <p>10min delay</p> <p>15min delay</p> <p>30min delay</p> <p>60min delay</p>	<p>Only after the time set here is the current state of the limiting value applied to the limiting value object. This means that</p> <ul style="list-style-type: none"> - a change of the limiting value to the value "0" is only sent after this time elapses, - with cyclic sending of the limiting value the changed value "0" is only sent after this time elapses. Therefore a "1" continues to be sent while the timer for the delay time is running. <p>i If the parameter "Activation limiting value" for a condition is set to "No telegram", then the cyclic telegrams are also suppressed when the set condition is fulfilled.</p>
Sending of limiting value 2 for value change	No	<p>The limiting value object is not sent when there is a change.</p> <p>If the parameter "Cyclic sending of the limiting value" is set to at least 1, then the limiting value object is sent cyclically regardless of any change.</p>

	Yes	<p>The limiting value object is sent when there is a change from "0" to "1" or a change from "1" to "0".</p> <p>i If this parameter "Sending of limiting value for value change" is set to "No" and the parameter "Cyclic sending of the limiting value" is set to "0", then the limiting value is not sent at all.</p>
Cycl. sending of the limiting value 2 (x10s)	0...120	<p>Set here whether and at what time interval the limiting value is sent. The set value multiplied by 10 is the repeat time in seconds. It is thus possible to set the cycle time in steps of 10 seconds. The value "0" means that the limiting value object is not sent cyclically.</p> <p>i If the parameter "Sending of limiting value for value change" is set to "No" and this parameter "Cyclic sending of the limiting value" is set to "0", then the limiting value is not sent at all.</p>
 Precipitation (Only visible if the parameter 'Precipitation' under 'General' is set to 'Activated'!)		
Limiting values	<p>not activated</p> <p>Limiting value 1 activated</p> <p>Limiting values 1 and 2 activated</p>	<p>Select here whether this sensor should have limiting values, and how many.</p> <p>i Limiting values that are not activated will not be displayed!</p>
 Precipitation limiting value 1 (Only visible if the parameter 'Precipitation' under 'General' is set to 'Activated' and the parameter 'Limiting values' is set here to 'Limiting value 1 activated' or to 'Limiting values 1 and 2 activated'!)		
Limiting value 1	<p>ON when raining</p> <p>OFF when raining</p>	<p>Set here whether a '1' (ON when raining) or a '0' (OFF when raining) is sent when it is raining</p> <p>i If the proper 24V supply voltage is not present, then rain will always be reported.</p>
Switch-on delay limiting value 1	<p>No delay</p> <p>1s delay</p> <p>3s delay</p> <p>5s delay</p> <p>10s delay</p> <p>15s delay</p> <p>30s delay</p> <p>1min delay</p> <p>3min delay</p> <p>5min delay</p> <p>10min delay</p> <p>15min delay</p> <p>30min delay</p> <p>60min delay</p>	<p>Only after the time set here will the current state of the limiting value be accepted in the limiting value object. This means that</p> <p>a change in the limiting value to "1" will only be sent after this time elapses; in the case of cyclic sending the limiting value of the changed value "1" is only sent after this time expires. Thus while the timer for the delay time is running, a "0" continues to be sent.</p> <p>i If the parameter "Activation limiting value" for a condition is set to "No telegram", then the cyclic telegrams are also suppressed when the set condition is fulfilled.</p>
Switch-off delay limiting value 1	<p>No delay</p> <p>1s delay</p> <p>3s delay</p> <p>5s delay</p>	<p>Only after the time set here is the current state of the limiting value applied to the limiting value object. This means that</p>

	<p>10s delay 15s delay 30s delay 1min delay 3min delay 5min delay 10min delay 15min delay 30min delay 60min delay</p>	<p>- a change of the limiting value to the value "0" is only sent after this time elapses, - with cyclic sending of the limiting value the changed value "0" is only sent after this time elapses. Therefore a "1" continues to be sent while the timer for the delay time is running.</p> <p>i If the parameter "Activation limiting value" for a condition is set to "No telegram", then the cyclic telegrams are also suppressed when the set condition is fulfilled.</p>
Sending of limiting value 1 for value change	No	<p>The limiting value object is not sent when there is a change. If the parameter "Cyclic sending of the limiting value" is set to at least 1, then the limiting value object is sent cyclically regardless of any change.</p>
	Yes	<p>The limiting value object is sent when there is a change from "0" to "1" or a change from "1" to "0".</p> <p>i If this parameter "Sending of limiting value for value change" is set to "No" and the parameter "Cyclic sending of the limiting value" is set to "0", then the limiting value is not sent at all.</p>
Cycl. sending of the limiting value 1 (x 10s)	0...120	<p>Set here whether and at what time interval the limiting value is sent. The set value multiplied by 10 is the repeat time in seconds. It is thus possible to set the cycle time in steps of 10 seconds. The value "0" means that the limiting value object is not sent cyclically.</p> <p>i If the parameter "Sending of limiting value for value change" is set to "No" and this parameter "Cyclic sending of the limiting value" is set to "0", then the limiting value is not sent at all.</p>
<p> Precipitation limiting value 2 (Only visible if the parameter 'Precipitation' under 'General' is set to 'Activated' and the parameter 'Limiting values' is set here to 'Limiting value 1 activated' or to 'Limiting values 1 and 2 activated!')</p>		
Limiting value 2	<p>ON when raining OFF when raining</p>	<p>Set here whether a '1' (ON when raining) or a '0' (OFF when raining) is sent when it is raining</p> <p>i If the proper 24V supply voltage is not present, then rain will always be reported.</p>
Switch-on delay limiting value 2	<p>No delay 1s delay 3s delay 5s delay 10s delay 15s delay 30s delay</p>	<p>Only after the time set here will the current state of the limiting value be accepted in the limiting value object. This means that a change in the limiting value to "1" will only be sent after this time elapses; in the case of cyclic sending the limiting</p>

	<p>1min delay 3min delay 5min delay 10min delay 15min delay 30min delay 60min delay</p>	<p>value of the changed value "1" is only sent after this time expires. Thus while the timer for the delay time is running, a "0" continues to be sent.</p> <p>i If the parameter "Activation limiting value" for a condition is set to "No telegram", then the cyclic telegrams are also suppressed when the set condition is fulfilled.</p>
Switch-off delay limiting value 2	<p>No delay 1s delay 3s delay 5s delay 10s delay 15s delay 30s delay 1min delay 3min delay 5min delay 10min delay 15min delay 30min delay 60min delay</p>	<p>Only after the time set here is the current state of the limiting value applied to the limiting value object. This means that</p> <ul style="list-style-type: none"> - a change of the limiting value to the value "0" is only sent after this time elapses, - with cyclic sending of the limiting value the changed value "0" is only sent after this time elapses. Therefore a "1" continues to be sent while the timer for the delay time is running. <p>i If the parameter "Activation limiting value" for a condition is set to "No telegram", then the cyclic telegrams are also suppressed when the set condition is fulfilled.</p>
Sending of limiting value 2 for value change	No	<p>The limiting value object is not sent when there is a change. If the parameter "Cyclic sending of the limiting value" is set to at least 1, then the limiting value object is sent cyclically regardless of any change.</p>
	Yes	<p>The limiting value object is sent when there is a change from "0" to "1" or a change from "1" to "0".</p> <p>i If this parameter "Sending of limiting value for value change" is set to "No" and the parameter "Cyclic sending of the limiting value" is set to "0", then the limiting value is not sent at all.</p>
Cycl. sending of the limiting value 2 (x10s)	0...120	<p>Set here whether and at what time interval the limiting value is sent. The set value multiplied by 10 is the repeat time in seconds. It is thus possible to set the cycle time in steps of 10 seconds. The value "0" means that the limiting value object is not sent cyclically.</p> <p>i If the parameter "Sending of limiting value for value change" is set to "No" and this parameter "Cyclic sending of the limiting value" is set to "0", then the limiting value is not sent at all.</p>

 Temperature sensor (Only visible if the parameter 'Temperature sensor' under 'General' is set to 'Activated!')
 (Measuring range -20...55°C)

Limiting values	not activated Limiting value 1 activated Limiting values 1 and 2 activated	Select here whether this sensor should have limiting values, and how many. i Limiting values that are not activated will not be displayed!
Send measured value at (10s sending delay)	0.5% measured value difference 1% measured value difference 3% Measured value difference 10% measured value difference	So as not to burden the bus with very frequent telegrams, the measured value should not be sent for every tiny change. As large a value as possible should be set here, taking the measurement task into account. i The percentage specification for the measured value difference is always relative to the measuring range upper range value! i A fixed sending delay of 10 seconds is set.
cycl. sending of the measured value (x 10s)	0...120	Set here whether and at what time interval the value is sent. The set value multiplied by 10 is the repeat time in seconds. It is thus possible to set the cycle time in steps of 10 seconds. The value "0" means that no cyclic sending is carried out. i The cyclic telegrams sent via this setting are independent of the telegrams that result from the setting "Send measured value when ... measured value difference.
<p> Temperature sensor limiting value 1 (Only visible if the parameter 'Temperature sensor' under 'General' is set to 'Activated' and the parameter 'Limiting values' is set here to 'Limiting value 1 activated' or to 'Limiting values 1 and 2 activated'!)</p>		
Limiting value 1 in °C	-15 °C -10 °C -5 °C (23 °F) -4 °C -3 °C -2 °C -1 °C 0 °C (32 °F) 1 °C 2 °C 3 °C 4 °C 5 °C (41 °F) 6 °C 7 °C 8 °C 9 °C 10 ° (10 °F)C 11 °C 12 °C 13 °C 14 °C 15 °C (59 °F) 16 °C 17 °C 18 °C 19 °C 20 °C (68 °F)	Set here the threshold for the limiting value in the range from -15 °C to +50 °C. i In conjunction with the parameters "Limiting value 1" and "Hysteresis limiting value 1", define the thresholds at which the limiting value object is set to "1" or "0" when they are exceeded or undershot.

	21 °C	
	22 °C	
	23 °C	
	24 °C	
	25 °C (77 °F)	
	26 °C	
	27 °C	
	28 °C	
	29 °C	
	30 °C (86 °F)	
	31 °C	
	32 °C	
	33 °C	
	34 °C	
	35 °C (95 °F)	
	40 °C	
	45 °C	
	50 °C (122 °F)	
Hysteresis limiting value 1 in K	No hysteresis 1 K 2 K 3 K 4 K 5 K 10 K 15 K 20 K	Set here the hysteresis in the range from no hysteresis to 20 K. i In conjunction with the parameters "Limiting value 1" and "Activation of limiting value 1", define the thresholds at which the limiting value object is set to "1" or "0" when they are exceeded or undershot.
Activation limiting value 1 LV=limiting value, hyst.=hysteresis	Exceed LV = ON, Undershoot LV-Hyst. = OFF Exceed LV = OFF, Undershoot LV-Hyst. = ON Undershoot LV = ON, Exceed LV+Hystr.= OFF Undershoot LV = OFF, Exceed LV+Hyst. = ON Exceed LV = ON, Undershoot LV-Hyst. = no telegr. Exceed LV = OFF, Undershoot LV-Hyst. = no telegr. Undershoot LV = ON, Exceed LV+Hyst. = no telegr. Undershoot LV = OFF, Exceed LV+Hyst. = no telegr. Exceed LV = no telegr., Undershoot LV-Hyst. = OFF Exceed LV = no telegr.,	Set here which action should be carried if the limiting value is crossed from a specifically defined direction. i In conjunction with the parameters "Limiting value 1" and "Hysteresis limiting value 1", define the thresholds at which the limiting value object is set to "1" or "0" when they are exceeded or undershot.

	Undershot LV-Hyst. = ON	
	Undershoot LV = no telegr., Exceed LV+Hyst. = OFF	
	Undershoot LV = no telegr., Exceed LV+Hyst. = ON	
External limiting value 1	No	No external limiting value 1 is parametrized
	16 bit value	The limiting value is specified by an external device via a 2 byte value object.
	8 bit value	The limiting value is specified by an external device via a 1 byte value object.
	Save limiting value via switching object (teaching)	When this external switching object is used it is possible, e.g. by pressing a pushbutton, to define the measured value of the sensor at that moment as a limiting value.
		<p>i Using an external object, the user of the building can set the limiting value to suit his needs without having to change the parametrization.</p> <p>i When a download is carried out, the external values are overwritten with the ETS data. Only when a value is received again after a download will that value be processed again.</p>
Switch-on delay limiting value 1	No delay 1s delay 3s delay 5s delay 10s delay 15s delay 30s delay 1min delay 3min delay 5min delay 10min delay 15min delay 30min delay 60min delay	<p>Only after the time set here will the current state of the limiting value be accepted in the limiting value object. This means that</p> <ul style="list-style-type: none"> - a change in the limiting value to "1" will only be sent after this time elapses; - in the case of cyclic sending the limiting value of the changed value "1" is only sent after this time expires. Thus while the timer for the delay time is running, a "0" continues to be sent. <p>i If the parameter "Activation limiting value" for a condition is set to "No telegram", then the cyclic telegrams are also suppressed when the set condition is fulfilled.</p>
Switch-off delay limiting value 1	No delay 1s delay 3s delay 5s delay 10s delay 15s delay 30s delay 1min delay 3min delay 5min delay 10min delay 15min delay 30min delay 60min delay	<p>Only after the time set here is the current state of the limiting value applied to the limiting value object. This means that</p> <ul style="list-style-type: none"> - a change of the limiting value to the value "0" is only sent after this time elapses, - with cyclic sending of the limiting value the changed value "0" is only sent after this time elapses. Therefore a "1" continues to be sent while the timer for the delay time is running.

Sending of limiting value 1 for value change	No	<p>i If the parameter "Activation limiting value" for a condition is set to "No telegram", then the cyclic telegrams are also suppressed when the set condition is fulfilled.</p>
	Yes	<p>The limiting value object is not sent when there is a change. If the parameter "Cyclic sending of the limiting value" is set to at least 1, then the limiting value object is sent cyclically regardless of any change.</p> <p>The limiting value object is sent when there is a change from "0" to "1" or a change from "1" to "0".</p>
Cycl. sending of the limiting value 1 (x 10s)	0...120	<p>i If this parameter "Sending of limiting value for value change" is set to "No" and the parameter "Cyclic sending of the limiting value" is set to "0", then the limiting value is not sent at all.</p> <p>Set here whether and at what time interval the limiting value is sent. The set value multiplied by 10 is the repeat time in seconds. It is thus possible to set the cycle time in steps of 10 seconds. The value "0" means that the limiting value object is not sent cyclically.</p>
		<p>i If the parameter "Sending of limiting value for value change" is set to "No" and this parameter "Cyclic sending of the limiting value" is set to "0", then the limiting value is not sent at all.</p>
<p> Temperature sensor limiting value 2 (Only visible if the parameter 'Temperature sensor' under 'General' is set to 'Activated' and the parameter 'Limiting values' is set here to 'Limiting values 1 and 2 activated!')</p>		
Limiting value 2 in °C	<ul style="list-style-type: none"> -15 °C -10 °C -5 °C (23 °F) -4 °C -3 °C -2 °C -1 °C 0 °C (32 °F) 1 °C 2 °C 3 °C 4 °C 5 °C (41 °F) 6 °C 7 °C 8 °C 9 °C 10 ° (10 °F)C 11 °C 12 °C 13 °C 14 °C 15 °C (59 °F) 	<p>Set here the threshold for the limiting value in the range from -15 °C to +50 °C.</p> <p>i In conjunction with the parameters "Limiting value 2" and "Hysteresis limiting value 2", define the thresholds at which the limiting value object is set to "1" or "0" when they are exceeded or undershot.</p>

	16 °C	
	17 °C	
	18 °C	
	19 °C	
	20 °C (68 °F)	
	21 °C	
	22 °C	
	23 °C	
	24 °C	
	25 °C (77 °F)	
	26 °C	
	27 °C	
	28 °C	
	29 °C	
	30 °C (86 °F)	
	31 °C	
	32 °C	
	33 °C	
	34 °C	
	35 °C (95 °F)	
	40 °C	
	45 °C	
	50 °C (122 °F)	
Hysteresis limiting value 2 in K	No hysteresis 1 K 2 K 3 K 4 K 5 K 10 K 15 K 20 K	Set here the hysteresis in the range from no hysteresis to 20 K. i In conjunction with the parameters "Limiting value 2" and "Activation of limiting value 2", define the thresholds at which the limiting value object is set to "1" or "0" when they are exceeded or undershot.
Activation limiting value 2 LV=limiting value, Hyst.=Hysteresis	Exceed LV = ON, Undershoot LV-Hyst. = OFF Exceed LV = OFF, Undershoot LV-Hyst. = ON Undershoot LV = ON, Exceed LV+Hyst.= OFF Undershoot LV = OFF, Exceed LV+Hyst. = ON Exceed LV = ON, Undershoot LV-Hyst. = no telegr. Exceed LV = OFF, Undershoot LV-Hyst. = no telegr. Undershoot LV = ON, Exceed LV+Hyst. = no telegr. Undershoot LV = OFF, Exceed LV+Hyst. = no telegr.	Set here which action should be carried if the limiting value is crossed from a specifically defined direction. i In conjunction with the parameters "Limiting value 2" and "Hysteresis limiting value 2", define the thresholds at which the limiting value object is set to "1" or "0" when they are exceeded or undershot.

	Exceed LV = no telegr., Undershoot LV-Hyst. = OFF	
	Exceed LV = no telegr., Undershot LV-Hyst. = ON	
	Undershoot LV = no telegr., Exceed LV+Hyst. = OFF	
	Undershoot LV = no telegr., Exceed LV+Hyst. = ON	
External limiting value 2	No	No external limiting value 2 is parametrized
	16 bit value	The limiting value is specified by an external device via a 2 byte value object.
	8 bit value	The limiting value is specified by an external device via a 1 byte value object.
	Save limiting value via switching object (teaching)	When this external switching object is used it is possible, e.g. by pressing a pushbutton, to define the measured value of the sensor at that moment as a limiting value.
		<p>i Using an external object, the user of the building can set the limiting value to suit his needs without having to change the parametrization.</p> <p>i When a download is carried out, the external values are overwritten with the ETS data. Only when a value is received again after a download will that value be processed again.</p>
Switch-on delay limiting value 2	No delay 1s delay 3s delay 5s delay 10s delay 15s delay 30s delay 1min delay 3min delay 5min delay 10min delay 15min delay 30min delay 60min delay	<p>Only after the time set here will the current state of the limiting value be accepted in the limiting value object. This means that</p> <ul style="list-style-type: none"> - a change in the limiting value to "1" will only be sent after this time elapses; - in the case of cyclic sending the limiting value of the changed value "1" is only sent after this time expires. Thus while the timer for the delay time is running, a "0" continues to be sent. <p>i If the parameter "Activation limiting value" for a condition is set to "No telegram", then the cyclic telegrams are also suppressed when the set condition is fulfilled.</p>
Switch-off delay limiting value 2	No delay 1s delay 3s delay 5s delay 10s delay 15s delay 30s delay 1min delay 3min delay	<p>Only after the time set here is the current state of the limiting value applied to the limiting value object. This means that</p> <ul style="list-style-type: none"> - a change of the limiting value to the value "0" is only sent after this time elapses, - with cyclic sending of the limiting value the changed value "0" is only sent after

	<p>5min delay 10min delay 15min delay 30min delay 60min delay</p>	<p>this time elapses. Therefore a "1" continues to be sent while the timer for the delay time is running.</p> <p>i If the parameter "Activation limiting value" for a condition is set to "No telegram", then the cyclic telegrams are also suppressed when the set condition is fulfilled.</p>
Sending of limiting value 2 for value change	No	<p>The limiting value object is not sent when there is a change. If the parameter "Cyclic sending of the limiting value" is set to at least 1, then the limiting value object is sent cyclically regardless of any change.</p>
	Yes	<p>The limiting value object is sent when there is a change from "0" to "1" or a change from "1" to "0".</p> <p>i If this parameter "Sending of limiting value for value change" is set to "No" and the parameter "Cyclic sending of the limiting value" is set to "0", then the limiting value is not sent at all.</p>
Cycl. sending of the limiting value 2 (x10s)	0...120	<p>Set here whether and at what time interval the limiting value is sent. The set value multiplied by 10 is the repeat time in seconds. It is thus possible to set the cycle time in steps of 10 seconds. The value "0" means that the limiting value object is not sent cyclically.</p> <p>i If the parameter "Sending of limiting value for value change" is set to "No" and this parameter "Cyclic sending of the limiting value" is set to "0", then the limiting value is not sent at all.</p>
<p> Monitoring (Only visible if the parameter 'Monitoring' under 'General' is set to 'Activated!')</p>		
Cyclic sending of the monitoring bits (x10s)	0...120	<p>Set here whether and at what time interval the monitoring bits are sent cyclically. The set value multiplied by 10 is the repeat time in seconds. It is thus possible to set the cycle time in steps of 10 seconds. The value "0" means that no cyclic sending is carried out.</p> <p>i The cyclic telegrams sent via this setting are independent of the fact that the specific telegrams of the individual monitoring bits are sent in any case with each change.</p>
Monitoring heating voltage	<p>24 V o.k = 0, 24V not o.k. = 1</p>	<p>Set here the polarity of the monitoring bit.</p>
	<p>24 V o.k = 1, 24V not o.k. = 0</p>	

Monitoring wind signal	Monitor Do not monitor	<p>i In order to obtain reliable measurement results it is necessary for the proper 24V AC/DC voltage to be present. If you use the weather station to protect costly outdoor equipment against the adverse effects of weather, then it is essential to monitor this voltage. If this voltage is not present, then the outdoor equipment must be placed in a protected state as quickly as possible.</p> <p>Set this parameter to "Monitor" to check whether the wind transmitter is supplying reasonable values.</p> <p>i If you use the weather station to protect costly outdoor equipment against the effects of wind, then you should check the supplied data for plausibility. Use the data to be entered for the parameters "Max. time for 'No wind' in hours" and "Max. time for 'Wind unchanged' in minutes". If the values do not appear to be reasonable, then for the sake of safety the outdoor equipment should be moved to a protected state as quickly as possible.</p>
Max. time for "No wind" in hours	1.1010...180	<p>If the time set here is exceeded, it is assumed that the wind signal is faulty, for example due to an electronic defect.</p> <p>i For reasonable values, please consult the meteorological station responsible for the location.</p> <p>i This parameter is only visible if the parameter "Monitor wind signal" is set to "Monitor".</p>
Max. time for "Wind unchanged" in minutes	1.1010...255	<p>If a constant wind signal is present for longer than the time set here, it will be assumed that there is a malfunction.</p> <p>i For a reasonable value, please consult the meteorological station responsible for the location.</p> <p>i This parameter is only visible if the parameter "Monitor wind signal" is set to "Monitor".</p>
<p> Logic gaten (<i>n</i> = number of the logic gate / Only visible if the parameter 'Logic gate <i>n</i>' under 'General' is set to 'Activated'!)</p> <p>Type of logic operation</p>		<p>Set here which logic operation is created by the gate</p>
AND		Only if all inputs are "1" will the output be "1"
OR		If one or more inputs are "1", then the output is "1"
Exclusive OR		

		Only if one input is "1" will the output be "1"
	AND with feedback	Only when all inputs are "1" (AND gate), and a "1" is received again by the feedback input will the output be "1"
		i NAND and NOR gates can be implemented by negation of the output
Send at	Each input event	The output object is sent at each input event. If, for example, a "1" is sent cyclically to an input, then the output state is sent in the same cycle
	Change of the output	The output is only sent when there is a change of the output from "0" to "1" or from "1" to "0".
Number of inputs	1 input 2 inputs 3 inputs 4 inputs	Setting of the number of required gate inputs
Response at output	Normal	If the result of the logic operation is "1", then the output object receives the value "1". If the result of the logic operation is "0", then the output object receives the value "0"
	Inverted	If the result of the logic operation is "1", then the output object receives the value "0". If the result of the logic operation is "0", then the output object receives the value "1"
Switch-on delay	No telegram	A change of the logic operation result from "0" to "1" will not be sent.
	Delay on	A change of the logic operation result from "0" to "1" will be sent with a delay. The delay is set using the basis and a factor in the range from 100 milliseconds to 100 minutes.
	No delay	A change of the logic operation result from "0" to "1" will be sent with no delay.
Basis	100ms 1s 1min	i Only visible if "Delay on" is parametrized.
Factor	1...100	i Only visible if "Delay on" is parametrized. <i>100ms</i>
Switch-off delay	No telegram	A change of the logic operation result from "1" to "0" will not be sent.
	Delay on	A change of the logic operation result from "1" to "0" will be sent with a delay. The delay is set using the basis and a factor in the range from 100 milliseconds to 100 minutes.

	No delay	A change of the logic operation result from "1" to "0" will be sent with no delay.
Basis	100ms 1s 1min	i Only visible if "Delay on" is parametrized.
Factor	1...100	i Only visible if "Delay on" is parametrized. <i>100ms</i>
Cyclic sending of the measured value (x10s)	0...120	Set here whether and at what time interval the result of the logic operation is sent. The set value multiplied by 10 is the repeat time in seconds. It is thus possible to set the cycle time in steps of 10 seconds. The value "0" means that no cyclic sending is carried out. i The cyclic telegrams sent via this setting are independent of the telegrams resulting from the setting "Send at".
 Logic gate n input (n = Number of the logic gate / Only visible if at least n gates have been activated in the parameter 'Logic gates' under 'General'!)		
Assign input 1	Internal input value	If this value is selected, a list appears with all of the outputs, error bits and limiting values available with the current parametrization. If, for example, limiting value 2 of brightness sensor 3 is not activated, then that output will not appear in this list.
	External input value	An external object (1bit) is assigned to the input
Assign input 2	Internal input value	If this value is selected, a list appears with all of the outputs, error bits and limiting values available with the current parametrization. If, for example, limiting value 2 of brightness sensor 3 is not activated, then that output will not appear in this list.
	External input value	An external object (1bit) is assigned to the input
Assign input 3	Internal input value	i Only visible if this input is activated under "Number of inputs". If this value is selected, a list appears with all of the outputs, error bits and limiting values available with the current parametrization. If, for example, limiting value 2 of brightness sensor 3 is not activated, then that output will not appear in this list.
	External input value	An external object (1bit) is assigned to the input

Assign input 4	Internal input value	<p>i Only visible if this input is activated under "Number of inputs".</p> <p>If this value is selected, a list appears with all of the outputs, error bits and limiting values available with the current parametrization. If, for example, limiting value 2 of brightness sensor 3 is not activated, then that output will not appear in this list.</p>
	External input value	<p>An external object (1bit) is assigned to the input</p> <p>i Only visible if this input is activated under "Number of inputs".</p>
<p> Blocking modulen ($n = \text{Number of the blocking module} / \text{Only visible if at least } n \text{ modules have been activated in parameter 'Blocking modules' under 'General!'}$)</p>		
Response of blocking object	Blocking with 0 telegram	<p>Telegrams with the blocking object value "0" block the blocking module, i.e. changes at the input are not passed on to the output.</p>
	Blocking with 1 telegram	<p>Telegrams with the blocking object value "1" block the blocking module, i.e. changes at the input are not passed on to the output.</p>
Blocking response upon initialization	Enabled Blocked	<p>Parameterise here whether the module is blocked after a bus voltage failure, programming or reset of the device, or whether input telegrams continue to be sent to the output.</p>
Type input/output	Switching - 1 bit Value - 2 bytes Rel. value - 1 byte	<p>Select here the object type (1 bit / 1 byte / 2 byte) that should be switched through.</p>
Switching - 1bit	Internal input value	<p>If this value is selected, a list appears with all of the outputs, error bits and limiting values available with the current parametrization. If, for example, limiting value 2 of brightness sensor 3 is not activated, then that output will not appear in this list.</p>
	External input value	<p>An external object (1bit) is assigned to the input</p>
Value - 2 bytes	Internal input value	<p>If this value is selected, a list appears with all of the outputs, error bits and limiting values available with the current parametrization. If, for example, brightness sensor 3 is not activated, then that output will not appear in this list.</p>
	External input value	<p>An external object (2 bytes) is assigned to the input</p>
Rel. value - 1 byte	External input value	<p>An external object (1 byte) is assigned to the input</p>

- i No internal relative values (1 byte) are present in this device. Therefore the "Internal input value" is not available for this type

5 Appendix

5.1 Index

A	
AND	40
AND with return.....	40
Application version for the ETS2 and ETS3a...c	13
Application version for the ETS3d.....	13
AST type.....	13
awning protection.....	41
B	
Beaufort.....	28
bft	28
Blocking elements.....	42
Blocking module.....	76
Brightness sensor.....	45
Brightness sensors.....	31
C	
Circular chart for brightness detection	31
Configuration.....	13
Cyclic sending of the limiting values	39
D	
dimensions.....	6
E	
ETS search paths.....	13
exclusive OR.....	40
External limiting value 1.....	17
F	
frequent switching backwards and forwards	34
H	
Hysteresis of the limiting values.....	34
K	
KNX/EIB type class.....	13
L	
Limiting value 1.....	17
Limiting value 2.....	17
Limiting value settings.....	33
limiting value specification.....	34
Location of brightness sensor.....	6
Location of the temperature sensor	6
Location of the thermal wind sensor	6
Location of the twilight sensor.....	6
Logic gate.....	73
logic gate configuration.....	41
Logic gates.....	40
M	
main area of application.....	3
Measured value for brightness.....	16
Measured value for brightness and twilight	17
Measured value for temperature.....	16
Measured value for twilight.....	16
Measured value for wind.....	16
Monitoring.....	72
mounting location.....	7
O	
OR	40
Orientation according to the sides of the building	10
Orientation in the compass directions	10
Orienting the weather station.....	9
P	
Plausibility check of the wind measurement	27
Precipitation.....	63
Precipitation sensor.....	32
Protecting outdoor equipment against damage from water	30
Protecting outdoor equipment against the effects of weather	25
Protection of outdoor equipment against damage from wind.	28
Protection of outdoor systems against damage from frost	25
R	
Response of the limiting value object	36
S	
Sending the measured values.....	33

Sensor surface of the precipitation 6
sensor

Switch-on and switch-off delay of 38
the limiting values

T

teaching function.....34,37

Temperature sensor..... 32,65

terminal box..... 8

Twilight.....51

Twilight sensor.....31

W

Wind sensor.....32,57

wind speed levels..... 28

Gira
Giersiepen GmbH & Co. KG
Elektro-Installations-
Systeme

Industriegebiet Mermbach
Dahlienstraße
42477 Radevormwald

Postfach 12 20
42461 Radevormwald

Deutschland

Tel +49(0)21 95 - 602-0
Fax +49(0)21 95 - 602-191

www.gira.de
info@gira.de