

Issue:  
09.06.2022  
21293200

# Heating actuator 6-gang with controller DRA

## Order No. 2129 00



## Table of Contents

<b>1</b>	<b>Product definition .....</b>	<b>4</b>
1.1	Product catalogue .....	4
1.2	Function .....	4
<b>2</b>	<b>Installation, electrical connection and operation .....</b>	<b>7</b>
2.1	Safety instructions .....	7
2.2	Device components .....	8
2.3	Fitting and electrical connection .....	9
2.4	Commissioning .....	13
2.5	Operation .....	14
2.5.1	Operating elements .....	14
2.5.2	Status displays and output behaviour .....	15
2.5.3	Operating modes .....	17
<b>3</b>	<b>Technical data .....</b>	<b>21</b>
<b>4</b>	<b>Software description .....</b>	<b>22</b>
4.1	Software specification .....	22
4.2	Software "Heating actuator 6-gang 20D311, 20D312" .....	23
4.2.1	Scope of functions .....	23
4.2.2	Notes on software .....	25
4.2.3	Object table .....	26
4.2.3.1	Objects for device functions .....	26
4.2.3.2	Objects for valve outputs .....	31
4.2.3.3	Objects for room temperature controllers .....	36
4.2.4	Functional description .....	53
4.2.4.1	Description of channel-independent functions .....	53
4.2.4.1.1	Parameter configuration .....	53
4.2.4.1.2	Priorities .....	54
4.2.4.1.3	Manual operation .....	56
4.2.4.1.4	Service mode .....	61
4.2.4.1.5	Collective feedback .....	64
4.2.4.1.6	Summer / winter switch-over .....	68
4.2.4.1.7	Heat requirement and largest command value .....	69
4.2.4.1.8	Pump control .....	74
4.2.4.1.9	Failure of the valve operating voltage .....	77
4.2.4.1.10	Internal group communication .....	79
4.2.4.2	Channel-oriented functional description .....	81
4.2.4.2.1	Valve direction of action .....	81
4.2.4.2.2	Reset behaviour .....	82
4.2.4.2.3	Data formats for command values .....	85
4.2.4.2.4	Cycle time .....	91
4.2.4.2.5	Forced position .....	94
4.2.4.2.6	Cyclical command value monitoring / emergency operation .....	96
4.2.4.2.7	Command value limit .....	99
4.2.4.2.8	Status functions .....	101
4.2.4.2.9	Short-circuit and overload detection .....	107
4.2.4.2.10	Valve rinsing .....	113

4.2.4.2.11	Operating hours counter .....	117
4.2.4.3	Channel-orientated functional description for controllers .....	121
4.2.4.3.1	Operating modes and operating mode change-over .....	121
4.2.4.3.2	Control algorithms and calculation of command values .....	124
4.2.4.3.3	Adapting the control algorithms .....	131
4.2.4.3.4	Operating mode switchover .....	134
4.2.4.3.5	Room temperature measurement .....	142
4.2.4.3.6	Temperature setpoints .....	145
4.2.4.3.7	Command value and status output .....	159
4.2.4.3.8	Disabling functions .....	165
4.2.4.3.9	Underfloor heating temperature limit .....	166
4.2.4.3.10	Response after a device reset .....	167
4.2.4.4	Delivery state .....	168
4.2.5	Parameters .....	169
4.2.5.1	169 .....	169
4.2.5.2	183 .....	183
4.2.5.3	Parameters for room temperature controllers .....	205
<b>5</b>	<b>Appendix .....</b>	<b>226</b>
5.1	Index .....	226

## 1 Product definition

### 1.1 Product catalogue

Product name: Heating actuator, 6-gang with controller

Use: Actuator

Design: RMD (rail-mounted device)

Order No. 2129 00

### 1.2 Function

#### General

The heating actuator is used for the activation of electrothermal actuators (ETA) for heating or cooling systems. It possesses 6 electronic outputs, each of which can silently activate up to 4 (AC 230 V) or 2 (AC 24 V) actuators. Both deenergised closed and deenergised opened actuators can be connected.

In addition, the actuator contains up to 6 room temperature controllers (RTC), which are integrated in the device software and which work independently of the process. The command value outputs of these controllers can be internally linked to the electronic valve outputs of the actuator, meaning that temperature control and valve activation can take place using just one bus device, if required. The use of external room temperature controllers (e.g. push-button sensors with RTC) is thus not absolutely essential, but is possible as the valve outputs can also be activated individually via the KNX. The integrated controllers can also transmit command value telegrams to the KNX and thus activate other heating actuators or fan coil actuators. The room temperature is made available to the integrated controllers via separate communication objects. All the controller functions (e.g. setpoint temperature specification, operating mode switchover, switchover of the operating mode) are controlled via KNX communication objects (object controller without its own operating elements), meaning that controller operation is possible via controller extensions or visualisations.

#### Functions of the electronic valve outputs

The heating actuator receives 1-bit or 1-byte command value telegrams, transmitted, for example, by external KNX room temperature controllers or by one of the internal controllers. The actuator controls its valve outputs either in switching form or with a PWM signal, according to the data format of the command values and the configuration in the ETS. The cycle time for constant PWM output signals can be configured separately for each valve output of the heating actuator. This allows individual adaptation to different actuator types.

On activation with constant command values, an optional command value limit can be designed, which allows the limitation of received command values at the "Minimum" and "Maximum" limits. A minimum command value can be used, for example, for the implementation of basic heating or cooling. A maximum command value allows the limitation of the effective command value range, which usually has a positive influence on the lifespan of actuators.

The heating actuator possesses a heat requirement and pump controller. This produces a positive impact on the energy consumption of a housing or commercial building through the transmission and evaluation of the largest command value in the heating or cooling system. The information on the largest active command value can be made available to suitable calorific furnaces with integrated KNX controller directly via a KNX telegram (1-byte), for example, to determine the optimum flow temperature. Alternatively or additionally, the heating actuator can even evaluate the command values of its outputs and make general heat requirement information available in the form of limiting value monitoring with hysteresis (1-bit, switching). Using a KNX switch actuator, this allows the energy-efficient activation of burner and boiler controllers with suitable control inputs (e.g. requirement-orientated switch-over between the reduction and comfort setpoint in a central combi boiler).

The heating actuator also allows switching activation of the circulation pump of the heating or cooling circuit via a 1-bit KNX telegram. When using pump control, the pump is only switched on by the actuator when at least one command value of the outputs exceeds a limiting value with hysteresis defined in the ETS. The pump is switched off when the limiting value is reached or undershot again. This saves electrical energy, as the pump is only activated by sufficiently

large, and thus effective, command values. Optional cyclical anti-sticking protection prevents the sticking of the pump, if it has not been switched on by the command value evaluation for a longer period of time.

To prevent calcification or sticking of a valve which has not been activated for some time, the actuator has an automatic valve rinsing function. Valve rinsing can be executed cyclically or using a bus command, causing the activated valves to run through the full valve stroke for a preset period of time. If necessary, the intelligent valve rinsing can be enabled. In so doing, cyclical rinsing using the full stroke is only executed when a defined minimum command value limiting value was not exceeded during actuator operation.

Cyclical monitoring of the command values can be performed as an option. If, during active cyclical monitoring, there are no command value telegrams during a preset time, then emergency operation is activated for the affected valve output, for which a configurable constant PWM command value can be preset. In addition, it is possible to activate a forced position separately for each output using a 1-bit KNX object. A defined PWM command value is set at the appropriate output.

Emergency operation and forced position can also be activated automatically in case of bus voltage failure, after bus / mains voltage return or after an ETS programming operation. If necessary, the command values for emergency operation and the forced position can be influenced by the summer and winter mode of the actuator, allowing the activation of different heating or cooling levels according to the season. The actuator permits switchover between summer and winter mode at any time using a 1-bit object.

The heating actuator possesses comprehensive feedback and status functions. The active command value can be made available as status information, transmitting either passively or actively, separately for each value output. A combined valve status allows the collective feedback of various functions of an output in a single 1-byte bus telegram.

The actuator is able to detect an overload or a short-circuit at the valve outputs and, in consequence, to protect them against destruction. Outputs which have experienced a short-circuit or a constant load are deactivated after an identification period. In this case, a short-circuit or overload signal can be transmitted via a KNX communication object. The actuator can also signal a failure of the valve voltage on the KNX.

The switch-on times of the valve outputs can be detected and evaluated separately by operating hours counters. In addition, service operation is available, which, during maintenance or installation, can move all assigned valve drives to a defined position (completely opened or completely closed) and can lock them against activation by command value telegrams. Both service mode and the locking status are preset by a 2-bit forced operation telegram.

## **Function of the room temperature controller**

Six controllers are integrated in the device software, which can be used for single-room temperature control. This allows the temperature to be set in up to 6 rooms or room areas to specified setpoints through independent control processes. Depending on the operating mode, current setpoint temperature and room temperature, using a controller means that a variable for heating or cooling control can be transmitted to the KNX for the control circuit or be forwarded internally to a valve output. The controller distinguishes between different operating modes (comfort, standby, night, frost/heat protection) each with their own temperature setpoints for heating or cooling. For heating and cooling functions, you can select continuous or switching PI or switching 2-point feedback control algorithms.

In addition to the heating or cooling basic level, activating an additional heater and/or cooling unit means that an additional heating or cooling unit can be used. In this connection, you can set the temperature setpoint difference between the basic and the additional level by a parameter in the ETS. For major deviations between the temperature setpoint and the actual temperature, you can activate this additional level to heat up or cool down a room faster. You can assign different control algorithms to the basic and additional stages.

For each controller, the room temperatures are then detected by one or possibly two external KNX temperature sensors (e.g. push-button sensors with temperature measurement).

## **Operation, mounting and electrical connection**

The operating elements (4 push-buttons) on the front panel of the device permit influencing of the electronic outputs of the actuator through manual operation, even without KNX bus voltage or in a non-programmed state (switch on and off / PWM). This feature permits a fast function

check of the connected actuators. Moreover, the statuses of the outputs in case of bus voltage failure or bus or mains voltage return and after ETS programming can be set separately.

The device has a mains voltage connection that is independent of the valve outputs for supplying the device electronics of the manual operation and integrated bus coupling unit. The device electronics and bus coupling unit are also supplied from the bus coupling unit so that an ETS programming operation or manual operation is also possible even if the mains voltage is not connected or is switched off. As long as the bus voltage is connected and ready for operation, no power is drawn from the device's internal power supply unit. This saves electrical energy.

The valve outputs possess a separate connection for the supply of the connected actuators (AC 24 V or AC 230 V).

The device is designed for mounting on DIN rails in closed compact boxes or in distributors in fixed installations in dry interior rooms.

- i We recommend using electrothermal actuators of make Gira or, alternatively, models of make Möhlenhoff (AA2004, AA4004) or Sauter (MTX). Always observe the technical data of the actuators and compare them with the technical properties of the heating actuator.

## 2 Installation, electrical connection and operation

### 2.1 Safety instructions

Electrical equipment may only be installed and fitted by electrically skilled persons. The applicable accident prevention regulations must be observed.

Failure to observe the instructions may cause damage to the device and result in fire and other hazards.

**Danger of electric shock.** Device is not suitable for disconnection from supply voltage. The load is not electrically isolated from the mains even when the device is switched off.

**Danger of electric shock.** Always disconnect before carrying out work on the device or load. In so doing, take all the circuit breakers into account, which support dangerous voltages to the device and or load.

Make sure during the installation that there is always sufficient insulation between the mains voltage and the bus. A minimum distance of at least 4 mm must be maintained between bus conductors and mains voltage cores.

The device may not be opened or operated outside the technical specifications.

## 2.2 Device components

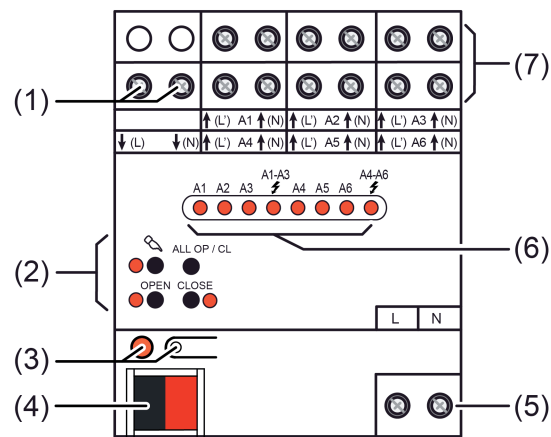

Figure 1: Device components

- (1) Connection for the supply of electrothermal actuators (AC 230 V or AC 24 V)
- (2) Button field for manual operation
- (3) Programming button and LEDs
- (4) KNX connection
- (5) Connection for mains voltage supply (AC 230 V)
- (6) Status LEDs for outputs
- (7) Connections for electrothermal actuators



## 2.3 Fitting and electrical connection



### DANGER!

Electrical shock when live parts are touched.

Electrical shocks can be fatal.

Before working on the device, disconnect the power supply and cover up live parts in the working environment.

### Fitting the device

- Snap onto a suitable DIN rail. The screw terminals of the valve outputs should be at the top.
- i** A KNX data rail is not required.
- i** Observe the temperature range (see Technical Data) and ensure sufficient cooling, if necessary.

### Connect the device for AC 230 V actuators

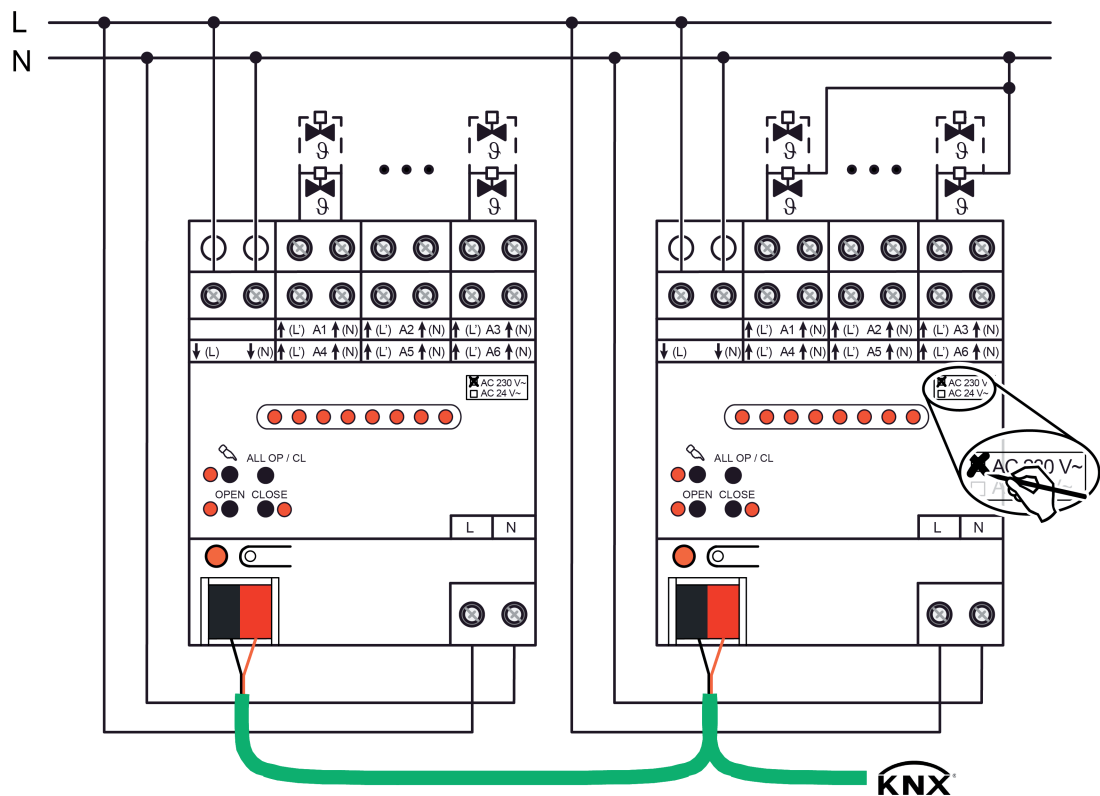

Figure 2: Connection for AC 230 V actuators (connection examples)  
 Left: Neutral conductor of the actuators run separately to the actuator /  
 Right: Shared neutral conductor for actuators

Only connect AC 230 V actuators to all the outputs.

Only connect actuators with the same characteristics to each output (deenergised closed/opened).

Do not connect unsuitable loads (incandescent lamps, motorised actuators, signal devices, etc.).

If possible, connect actuators for environments with increased fail-safety requirements to the outputs A1 and A4. During overload detection, these are switched off last.

Do not exceed the maximum number of "4" actuators per output.

Observe the technical data of the valve drives used.

- Connect the AC 230 V valve drives according to the connection diagram (Figure 2). The neutral conductors of the actuators can either be connected directly to the N terminals of the outputs of the heating actuator (left-hand connection example) or, alternatively, jointly with a suitable N potential (e.g. N conductor terminal in the distributor) (right-hand connection example). It is not absolutely necessary to connect the neutral conductor of the actuators directly to the actuator.
- ⓘ The neutral conductor terminals of the valve outputs are bridged internally in the device. Do not connect the neutral conductor from the output terminals through to additional devices in the distribution board or to other consumers. Only use the neutral conductor terminals of the outputs for the connections of the actuators of an actuator.
- Connect the supply (mains voltage AC 230 V) for the actuators to the terminals ↓(L) and ↓(N) (1).
- ⓘ Do not connect direct current.
- On the device label, note the type of supply "AC 230 V" with a permanent marker.
- Connecting the mains voltage to the terminals L N (5).
- ⓘ The neutral conductor connection of the mains connection terminal is independent of the N terminals of the valve outputs.
- Connect bus line with connecting terminal.

## Connect the device for AC 24 V actuators

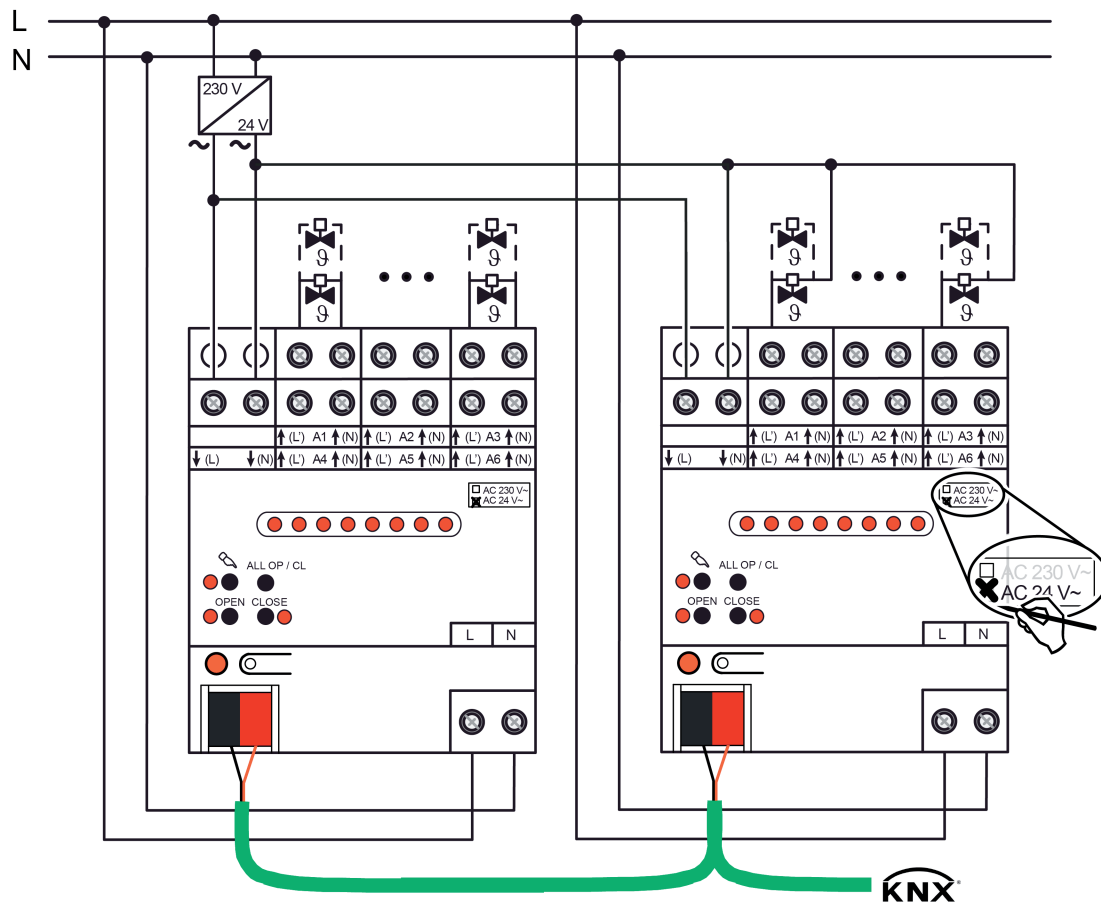

Figure 3: Connection for actuators AC 24 V  
 Left: Isolated connection of the actuators, separately on the actuator /  
 Right: Shared conductor for actuators

Only connect AC 24 V actuators to all the outputs.

Only connect actuators with the same characteristics to each output (deenergised closed/opened).

Do not connect unsuitable loads (incandescent lamps, motorised actuators, signal devices, etc.).

If possible, connect actuators for environments with increased fail-safety requirements to the outputs A1 and A4. During overload detection, these are switched off last.

Do not exceed the maximum number of "2" actuators per output.

Observe the technical data of the valve drives used.

- Connect the AC 24 V valve drives according to the connection diagram (Figure 3). It is possible to connect the actuators individually and directly with the terminals of the outputs of the heating actuator (left-hand connection example) or, alternatively, using a shared conductor (right-hand connection example).
- i** The terminals of the valve outputs indicated with "(N)" are bridged internally in the device. The terminals may only be used for the connection of the actuators of an actuator. Never connect N potential (mains voltage)!
- Connect the supply for the actuators (AC 24 V) to the terminals ↓(L) and ↓(N) (1). In so doing, use a low voltage AC 24 V from a suitable power supply (transformer, mains power supply).
- i** Do not connect direct current.

- On the device label, note the type of supply "AC 24 V" with a permanent marker.
- Connect mains voltage AC 230 V to the terminals **L N** (5).
- ⓘ The neutral conductor connection of the mains connection terminal is independent of the N terminals of the valve outputs.
- Connect bus line with connecting terminal.

## 2.4 Commissioning

After installation of the actuator and connection of the bus line, the mains power supply, the power supply of the actuators and of all electrical loads, the device can be put into operation. The following procedure is generally recommended...

### Commissioning with the ETS

---



#### **DANGER!**

**Electrical shock when live parts are touched.**

**Electrical shocks can be fatal.**

**Before working on the device, disconnect the power supply and cover up live parts in the working environment.**

---

- Switch on the bus voltage. Make sure that the bus voltage is available interruption free during the commissioning.
- ◻ **i** The device has a mains voltage connection that is independent of the valve outputs for supplying the device electronics of the manual operation and integrated bus coupling unit. The device electronics and bus coupling unit are also supplied from the bus coupling unit so that an ETS programming operation or manual operation is also possible even if the mains voltage is not connected or is switched off. As long as the bus voltage is connected and ready for operation, no power is drawn from the device's internal power supply. This saves electrical energy.
- Configure and program the physical address with the help of the ETS.
- Download the application data with the ETS.  
The device is ready for operation.
- ◻ **i** When the mains supply is on, the valve outputs of the actuator can be switched via manual operation, even if there is no bus voltage or if the actuator is not yet programmed. Due to this feature, the actuators connected to the individual outputs can be checked for proper functioning already during construction site operation.

## 2.5 Operation

### 2.5.1 Operating elements

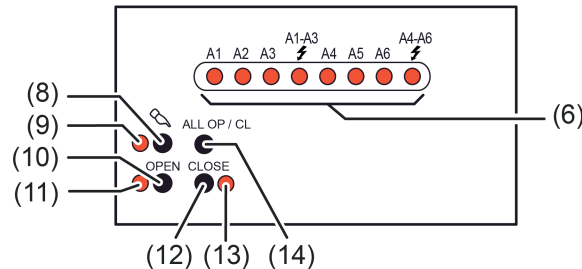

Figure 4: Controls and indicators on the front panel of the device

- (6) **A1...A6**: Status LEDs of the valve outputs (LEDs light up when outputs are energised)  
**⚡A1-A3, ⚡A4-A6**: Display "Overload/short-circuit" for appropriate output group
  - (8) Button : Activation / deactivation of manual control
  - (9) LED : Indicates permanent manual operation when ON.
  - (10) **OPEN** button: Open valve (configured valve direction of action is taken into account)
  - (11) **OPEN** LED: When ON in manual operation, signals an opened or opening valve
  - (12) **CLOSE** button: Close valve (configured valve direction of action is taken into account)
  - (13) **CLOSE** LED: When ON in manual operation, signals a closed or closing valve
  - (14) **ALL OP / CL** button: Central operating function for all valve outputs. Open and close all the valves alternately.
- i** **OPEN** (10) and **CLOSE** (13) LEDs: The LEDs light up statically during manual operation, showing the valve status set or to be set (valve is closed or closing / valve is opened or opening). Even on valve outputs working with an 8-bit command value (PWM), the LEDs display the logical valve state statically in the same way. The LEDs do not signal the dynamic switch-on and switch-off phases of the pulse width modulation. If no valve voltage is connected or switched on at the terminals **↓(L)** and **↓(N)**, then the LEDs are also always switched off, even if bus voltage or mains voltage is available (terminals **L N**), as the valve outputs cannot be energised.

## 2.5.2 Status displays and output behaviour

### Status indication

The Status LEDs **A1...A6** show whether the current flow is switched on or switched off at the appropriate output. The connected heating or cooling valves open and close according to their characteristics.

Valve drive	LED ON	LED OFF
Deenergised closed	Output energised Valve opened / Opening phase Active heating or cooling	Output not energised Valve closed / Closing phase
Deenergised opened	Output energised Valve closed / Closing phase	Output not energised Valve opened / Opening phase Active heating or cooling

Status display according to the energisation state of the valve outputs

- i** In the case of valve outputs working with an 8-bit command value (PWM), the LEDs dynamically display the switch-on and switch-off phases of the pulse width modulation.
- i** If no valve voltage is connected or switched on at the terminals  $\downarrow(L)$  and  $\downarrow(N)$ , then all the status LEDs are also always switched off, even if bus voltage or mains voltage is available (terminals **L N**), as the valve outputs cannot be energised.
- i** On the LED status display, the valve direction of action configured for each output in the ETS is not taken into account. As a result, the LEDs do not immediately display the valve state (opened / closed). Inversion of the status display according to the valve direction of action thus does not take place.

### Short-circuit / overload display

In order to protect the device and connected actuators, in case of overload the device determines which output is involved and switches it off. Non-overloaded outputs continue to work, which means that the corresponding rooms are still heated or cooled.

- In the case of short-circuits or overloads, the actuator first switches off the affected output groups **A1...A3** or **A4...A6**.
- The actuator determines the overloaded or short-circuited output in up to 4 testing cycles.
- If, in the event of only a minor overload, it is not possible to unambiguously identify any output as overloaded, then the actuator switches individual outputs of the overloaded group off one after the other.
- A detected overload or a detected short-circuit can be sent separately to the KNX using a 1-bit signal telegram for each valve output.

The status LEDs **A1-A3** or **A4-A6** on the front panel of the device flash slowly during the time of an overload or short-circuit identification (1 Hz) to signalise that the output groups are temporarily deactivated. The LEDs flash quickly when the actuator has safely identified all or individual valve outputs of the affected group as overloaded or having short-circuited.

- i** In the testing phase of a short-circuit/overload detection, the outputs of the affected group(s) cannot be selected during manual operation.
- i** The testing cycle is explained in detail in the "Software description" chapter of this documentation.

## Activation of the outputs in manual mode

During manual operation, all the valve outputs are activated with a pulse width modulation (PWM) using the **OPEN** button, irrespective of the configured command value data format (1-bit or 1-byte). The cycle time of the PWM signal for a valve output activated by manual operation is configured centrally on the parameter page "Manual operation" in the ETS. In consequence, a manual operation locally on the device can allow the use of a different cycle time than in normal operation of the actuator (activation via KNX telegrams). The **CLOSE** command always closes the valves completely (0 %).

An exception is the central operating function of all valve outputs with the **ALL OP / CL** button. Here, the actuator always activates the valve outputs with a constant signal (0 % or 100 %).

In manual operation, the configured valve direction of action (deenergised closed / deenergised opened) is taken into account during valve activation. With deenergised closed valves, the switch-on time is derived directly from the configured PWM and the cycle time. Example: PWM = 30 %, cycle time = 10 minutes -> Switch-on time = 3 minutes, switch-off time = 7 minutes.

In the case of deenergised opened valves, the switch-on time is inverted. Example: PWM = 30 %, cycle time = 10 minutes -> Switch-on time = 7 minutes, switch-off time = 3 minutes.

- i** Pressing the **OPEN** button when valves are already opened produces no reaction. The cycle time of a PWM signal is not restarted. On previously closed valves, pressing the **CLOSE** button also does not produce a reaction.
- i** After permanent manual operation has been switched on, the states of the outputs last set initially remain active. However, for opened valve outputs, the pulse width modulation is automatically adjusted to the preset value of manual operation. After temporary manual operation is switched on, the states of the outputs last set also initially remain active. However, for opened valve outputs, the pulse width modulation is not adjusted to the preset value of manual operation. This only takes place when the valves are first closed and then reopened, in the course of brief manual operation.
- i** In the state as supplied, the valve direction of action for all the valve outputs is set to "Deenergised closed". The actuator then works with a PWM of 50 % and a cycle time of 20 minutes.

## First Open function

In most cases, deenergised closed actuators possess the "First Open function". Such an actuator must, before it can be used normally in combination with the heating actuator, be energised for a specific period during the first electrical commissioning, in order to deactivate an internal mechanical block.

Normally, an intact block in the as-delivered state of the drives means that the actuator does not close fully. This means that the flow rate of the actuators and the hydraulic system can be checked as part of installation and commissioning, even without electrical actuation of the drives. An additional advantage is that the small opening of the valve in the as-delivered state means that systems can heat or cool in a restricted area (frost/heat protection), without the existence of a functioning room temperature control.

- i** Deenergised closed actuators with the First Open function are not usually completely closed in the as-delivered state. Such drives must be unlocked using the First Open function, thus activating them for use by the heating actuator.

The activation of the actuators for the execution of the First Open function is easily possible using manual operation of the heating actuator (in construction site mode, only through an applied mains and valve power supply). In the as-delivered state, the actuator works with a PWM of 50 % and a cycle time of 20 minutes. This produces a switch-on time of 10 minutes, when the command "Open valve" is executed in manual operation. This time is sufficiently long to execute the First Open function properly. In the ETS, both the cycle time and the PWM of manual operation can be configured and thus adjusted to a desired value.

Alternatively, the central operating function can be used with the **ALL OP / CL** button to execute the First Open function. In so doing, all the valve outputs execute the open or close command simultaneously (depending on the most recent presetting).



## 2.5.3 Operating modes



The manual operation of the actuator distinguishes between the following operating modes...

- Bus operation: Operation via room temperature controllers, push-buttons, or other bus devices,
- Temporary manual control: manual control locally with keypad, automatic return to bus control,
- Permanent manual operation: Exclusively manual operation on the device (e.g. construction site mode, commissioning phase).

- i** When manual control is active, the outputs cannot be controlled via the bus.
- i** In cases of bus voltage failure, manual operation is possible, provided that the mains voltage supply of the actuator (terminals **L N**) is switched on. On bus voltage return, manual operation can be terminated (central reset function) or continued without interruption, depending on the configuration.
- i** In manual mode, bus operation can be disabled via a telegram. Manual control is terminated on activation of the disabling function.
- i** No manual operation of the device is possible if the actuator is programmed by the ETS with an incorrect application program or if the application program was unloaded. In the state of the actuator as supplied, manual control can be used even before commissioning via the ETS (building site operation).
- i** Further details concerning manual operation, especially with respect to the possible parameter settings and the interaction with other functions of the actuator, can be found in chapter 4 "Software description" of the present documentation.

### Switching on the temporary manual control

Manual operation is enabled in the ETS and not blocked.

- Press the  button briefly.  
Temporary manual control is active.  
The status LED **A1** flashes. The LED  remains off.
- i** After the temporary manual operation is switched on, the most recently set states of the outputs initially remain active. For opened valve outputs, the pulse width modulation is not adjusted to the preset value of manual operation. This only takes place when the valves are first closed and then reopened, in the course of brief manual operation.
- i** After 5 seconds without a button-press, the actuator returns automatically to bus operation.

### Switching off temporary manual operation

The device is in short-term manual mode.

- No button-press for 5 seconds.  
- or -
- Select all outputs one after another by a brief press of the  button. Thereafter, press the key once again.  
- or -
- Switch off the mains voltage and the bus voltage.  
- or -
- On bus voltage return when mains voltage is available, although only when the parameter "Response of the manual operation to bus voltage return" is configured as "Exit manual operation".



Bus operation is active. LEDs **A1...A6** no longer flash, but rather indicate the output status, provided that the valve power supply and the bus or mains voltage is switched on.

- i** Manual operation is always exited after an ETS programming operation.
- i** The state of all outputs set via manual control is not changed when temporary manual control is switched off. If, however, a function with a priority higher than that of normal operation (e.g. forced position, safety operation) was activated for the valve outputs via the bus before or during manual operation, the actuator executes the function with the higher priority for the outputs concerned.

## Switching on permanent manual control

Manual operation is enabled in the ETS and not blocked.

Bus operation or temporary manual control is active.

- Press the  button for at least 5 seconds.  
Permanent manual operation is active and the LED  is illuminated. The status LED **A1** flashes. The two status LEDs **OPEN** and **CLOSE** show the current status of A1.
- i** After permanent manual operation has been switched on, the states of the outputs last set initially remain active. However, for opened valve outputs, the pulse width modulation is automatically adjusted to the preset value of manual operation.

## Switching off permanent manual control

The device is in continuous manual mode.

- Press the  button for at least 5 seconds.
  - or -
- Switch off the mains voltage and the bus voltage.
  - or -
- Block manual operation via the corresponding disabling object,
  - or -
- On bus voltage return when mains voltage is available, although only when the parameter "Response of the manual operation to bus voltage return" is configured as "Exit manual operation".  
Bus operation is active. LEDs **A1...A6** no longer flash, but rather indicate the output status, provided that the valve power supply and the bus or mains voltage is switched on.
- i** Manual operation is always exited after an ETS programming operation.
- i** Depending on the configuration of the actuator in the ETS, the outputs will be set to the state last adjusted in the manual operation or to the state internally tracked (e.g. forced position, service operation) when permanent manual operation is switched off.

## Operating the outputs

In manual operation the outputs can be operated instantly. The outputs are always activated with pulse width modulation by manual operation with the **OPEN** command. The cycle time of the PWM signal for a valve output activated by manual operation is configured centrally on the parameter page "Manual operation" in the ETS. The **CLOSE** command closes the valves completely (0 %).

The device is in continuous or short-term manual mode.

- Press  button briefly, < 1 s, as many times as necessary until the desired output is selected.

The LED of the selected output **A1...A6** flashes. Additionally, the status of the selected output is indicated by the LED **OPEN** or **CLOSE**.

- Press the **OPEN** button.  
The valve opens (configured valve direction of action is taken into account).
- Press the **CLOSE** button.  
The valve closes (configured valve direction of action is taken into account).  
The LEDs **OPEN** and **CLOSE** display the valve status.
- i** Short-term manual operation: After running through all of the outputs, the device exits manual operation after another brief press of the  button.
- i** Executing the **OPEN** command when valves are already opened causes no reaction. The cycle time of a PWM signal is not restarted. On previously closed valves, pressing the **CLOSE** button also does not produce a reaction.
- i** Depending on the parameter configuration in the ETS, feedback telegrams are transmitted to the bus via the status objects of an output during operation, as necessary.

### Operate all outputs simultaneously

All the valve outputs of the actuator can be activated at the same time. In contrast to the operating function using the **OPEN** or **CLOSE** buttons, the actuator always activates the valve outputs with a constant signal (0 % or 100 %), when they are activated simultaneously. Thus, the valves close or open completely. No pulse width modulation is executed.

This operating function is particularly practical for performing the First Open function of deenergised closed valves during first commissioning.

The device is in continuous manual mode.

- Press the **ALL OP / CL** button.  
Each time the button is pressed, the valves open and close alternately (all open -> all close -> all open...). The configured valve direction of action is taken into account.
- i** Executing the **OPEN** central command when valves are already opened causes PWM to be terminated. The command value switches to 100 %. The cycle time of a PWM signal is not restarted. On previously closed valves, executing the **CLOSE** central command does not produce a reaction.
- i** The **ALL OP / CL** button has no function in temporary manual operation. In this case pressing this button produces no reaction.

### Disabling bus control of individual outputs manually

It is possible to use manual operation to disable selected valve outputs in such a way that they can no longer be activated via the bus.

The device is in continuous manual mode.

Disabling of the bus control mode must have been enabled in the ETS.

- Press  button briefly as many times as necessary until the desired output is selected.  
The status LED of the selected output **A1...A6** flashes. The two status LEDs **OPEN** and **CLOSE** show the current status of the selected output.
- Press the **OPEN** and **CLOSE** buttons simultaneously for at least 5 seconds.  
The selected valve output is disabled (activation via the bus no longer possible). The status LED of the disabled output flashes quickly and constantly (even with manual operation deactivated).

- i** An output that has been disabled in manual control can thereafter only be operated in permanent manual control.

### **Cancelling the disabling of bus control of individual outputs via manual operation**

The device is in continuous manual mode.

Bus control of a valve output has been disabled previously in permanent manual operation.

- Press  button briefly as many times as necessary until the desired output is selected.  
The status LED of the selected output **A1...A6** flashes quickly. The two status LEDs **OPEN** and **CLOSE** show the current status of the selected output.
- Press the **OPEN** and **CLOSE** buttons simultaneously for at least 5 seconds.  
Selected output is enabled.  
The selected valve output is re-enabled (activation via the bus is possible again after manual operation has been deactivated).  
The status LED of the enabled output flashes slowly.

## 3 Technical data

### General

Ambient temperature	-5 ... +45 °C
Storage/transport temperature	-25 ... +70 °C
Fitting width	72 mm / 4 modules
Mark of approval	KNX / EIB
Standby power	max. 0.4 W
Power loss	max. 1 W

### KNX supply

KNX medium	TP
Commissioning mode	S-mode
Rated voltage KNX	DC 21 ... 32 V SELV
Power consumption KNX	max. 250 mW

### Device power supply AC 230 V (L, N)

Rated voltage	AC 110 ... 230 V ~
Mains frequency	50 / 60 Hz

### Power supply of valve outputs AC 230 V

Rated voltage	AC 230 V ~
---------------	------------

### Power supply of valve outputs AC 24 V

Rated voltage	AC 24 V ~
---------------	-----------

### Valve outputs

Contact type	Semi-conductor (Triac), ε
Switching voltage	AC 24 / 230 V ~
Switching current	5 ... 160 mA
Switch-on current	max. 1.5 A (2 sec)
Switch-off current	max. 0.3 A (2 min)
Number of drives per output	
230 V drives	max. 4
24 V drives	max. 2

### Connections

Connection mode	Screw terminal
Connection type for bus	Device connection terminal
single stranded	0.5 ... 4 mm <sup>2</sup>
Finely stranded without conductor sleeve	0.5 ... 4 mm <sup>2</sup>
Finely stranded with conductor sleeve	0.5 ... 2.5 mm <sup>2</sup>

## 4 Software description

### 4.1 Software specification

ETS search paths: heating, air condition / valves / Heating actuator, 6-gang with controller

#### Application:

No.	Short description	Name	Version	from mask version
1	Multifunctional heating actuator application: Activation of up to 6 valve outputs for electrothermal actuators. Optionally with room temperature control through 6 integrated room temperature controllers. With manual control.	Heating actuator 6-gang 20D311	1.1 for ETS4 Version 4.2 onwards and ETS5	SystemB (07B0)
2	Multifunctional heating actuator application: Activation of up to 6 valve outputs for electrothermal actuators. Optionally with room temperature control through 6 integrated room temperature controllers. With manual control. Error correction in RTC 6.	Heating actuator 6-gang 20D312	1.2 for ETS4 Version 4.2 onwards and ETS5	SystemB (07B0)

## 4.2 Software "Heating actuator 6-gang 20D311, 20D312"

### 4.2.1 Scope of functions

#### Valve outputs

- 6 independent electronic valve outputs.
- Valve activation (deenergised opened / closed) can be configured for each output.
- Actuator evaluation as "Switching, 1-bit", "Constant, 1-byte" or "Constant 1-byte with actuator limiting value and hysteresis".
- With a 1-byte command value, the outputs are activated by pulse width modulation (PWM). The cycle time can be configured for each valve output.
- Status feedback (1 bit or 1 byte) of each output possible automatically or on read request.
- Collective feedback of all valve states possible via 4-byte telegram.
- A combined valve status allows the collective feedback of various functions of an output in a single 1-byte bus telegram.
- Failure signal of the valve operating voltage can be configured (1-bit).
- Overload and short-circuit signal can be set separately via a 1-bit object for each valve output (polarity can be configured). Global reset of all short-circuit / overload signals possible.
- Heat requirement and pump control, for positive influencing of the energy consumption of a housing or commercial building. Provision of the largest active command value directly via KNX telegram (1-byte constant). Alternatively or additionally, evaluation of the actuator command values for provision of the general heat requirement information in the form of limiting value monitoring with hysteresis (1-bit switching). Activation of a circulation pump of the heating or cooling circuit via a 1-bit KNX telegram with limiting value evaluation. Optional cyclical anti-sticking protection prevents the sticking of the pump.
- Summer or winter mode can be selected via an object (polarity configurable).
- Each valve output can be locked in a forced position with bus control. Different command values can be configured for summer and winter mode.
- Cyclical monitoring of the command value of each output can be set, taking into account a configurable monitoring time. If no telegram is received within the preset monitoring time, the valve output concerned switches to emergency operation. Different command values can be configured for summer and winter mode. The fault telegram is configurable.
- On activation with constant command values, an optional command value limit can be designed, which allows the limitation of received command values at the "Minimum" and "Maximum" limits.
- Automatic valve rinsing to prevent calcification or sticking of a valve which has not been activated for some time.
- Operating hours counter to record the switch-on times of the valve outputs.
- Service mode for the maintenance or installation of valve drives (locking of the valve outputs in a defined state). Both service mode and the locking status are preset by a 2-bit forced operation telegram.
- Manual operation of outputs independent of the KNX (for instance, construction site mode) with LED status indicators. Separate status feedback to the KNX for manual operation. Manual operation can also be disabled via the KNX. Own cycle time and PWM setting for manually-operated valve outputs. Central activation of all valve outputs (0 % / 100 %).
- Behaviour in case of bus voltage failure and bus voltage return as well as after ETS programming settable for each valve output.
- Various actively transmitting feedback or status signals can be delayed globally after bus voltage return or after an ETS programming operation.
- The parameters of the outputs can be set individually (each valve output possesses its own parameters) or globally (all the valve outputs are configured in the same way with a single configuration).

#### Room temperature controller

- Up to 6 independent room temperature controllers.
- Individual control of a controller using communication objects.
- Various operating modes can be activated: Comfort, Standby, Night and Frost/heat protection
- Each operating mode can be assigned its own temperature-setpoints (for heating and/or cooling).

- Configuring the temperature setpoints as relative (derived from basic setpoint) or absolute (independent setpoint temperatures for each operating mode).
- Comfort extension possible using presence button in Night or Frost/heat protection mode. Configurable duration of the comfort extension.
- Operating mode switchover via 1-byte objects according to the KNX specification or using up to four individual 1-bit objects.
- Status feedback telegrams (also KNX compliant) can be configured.
- Frost/heat protection switchover via window status or by automatic frost protection.
- Operating modes "Heating", "Cooling", "Heating and cooling" each with or without additional level. The temperature setpoints for the additional level are derived via a configurable level offset from the values of the basic level.
- Various control types can be configured for each heating or cooling level: PI control (permanent or switching PWM) or 2-point feedback control (switching).
- Control parameter for PI controller (if desired: proportional range, reset time) and 2-point controller (hysteresis) adjustable.
- Automatic or object oriented switch-over between "heating" and "cooling".
- A temporary or permanent setpoint shift for a relative setpoint specification through communication objects is possible (e.g. via a controller extension).
- Configurable step width of the setpoint shift (0.1 K / 0.5 K).
- Deactivating the feedback control or the additional level possible using separate 1-bit objects.
- Room temperature measurement via up to two external KNX temperature sensors. Calibration of the temperature values possible and measured value formation of the external sensors can be configured. Settable polling time of the externally received temperature values.
- The actual and setpoint temperatures can be output on the bus if a configurable deviation is detected (also periodically).
- Separate or shared command value output in heating and cooling mode. This produces one or two command value objects for each level.
- Normal or inverted command value output configurable
- Automatic transmission and cycle-time for actuating output configurable
- Command value limit possible.
- Floor temperature limit possible in heating mode. Thus temperature-controlled switch-off of a floor heater as protective function.
- Setpoint temperature limit possible in cooling mode. If necessary, the controller limits the setpoint temperature to specific values and prevents an adjustment beyond statutory limits.



## 4.2.2 Notes on software

### ETS project design and commissioning

For project design and commissioning of the device, ETS4 from Version 4.2 onwards or ETS5 is required.

### Safe-state mode

If the device - for instance as a result of errors in the project design or during commissioning - does not work properly, the execution of the loaded application program can be halted by activating the safe-state mode. In safe-state mode, activation of the MSA outputs via the KNX or manual operation is not possible. The room temperature controllers also have no function. The actuator remains passive in safe-state mode, since the application program is not being executed (state of execution: Terminated). Only the system software is still functional so that the ETS diagnosis functions and also programming of the device continue to be possible.

### Activating the safe-state mode

- Shut off the bus and the mains voltage supply. Wait a bit.
- Press and hold down the programming button.
- Switch on the bus or mains voltage. Release the programming button only after the programming LED starts flashing slowly.

The safe-state mode is activated. With a new brief press of the programming button, the programming mode can be switched on and off as usual also in the safe-state mode. The programming LED stops flashing. However, safe-state mode remains active.

- i The safe-state mode can be terminated by switching off the supply voltage (bus and mains) or by programming with the ETS.

### Unloading the application program

The application program can be unloaded with the ETS. In this case the device is without function. Manual operation is no longer possible.

## 4.2.3 Object table

Number of communication objects: 104  
 (max. object number 284 - gaps in between)

Number of addresses (max.): 760

Number of assignments (max.): 760

### 4.2.3.1 Objects for device functions

---

Function:	Monitoring of the operating voltage				
Object	Function	Name	Type	DPT	Flag
 <sup>1</sup>	Failure of operating voltage	Valve outputs - Output	1-bit	1.005	C, -, T, R
Description	1-bit output object to signal a failure of the operating voltage (AC 24 V or AC 230 V) of the valve outputs. The telegram polarity can be configured.				

---

Function:	Pump control				
Object	Function	Name	Type	DPT	Flag
 <sup>2</sup>	Switch pump	Pump - output	1-bit	1.001	C, -, T, R
Description	1-bit output object for direct activation of a circulation pump of the heating or cooling system. The pump is only switched on by the actuator when at least one command value of the assigned outputs exceeds a limiting value with hysteresis defined in the ETS. The pump is switched off when the limiting value is reached or undershot again. In addition, the actuator can optionally evaluate an external telegram (object 3). The telegram polarity can be configured. After bus voltage return and an ETS programming operation, the actuator always first transmits the status "Pump OFF" without a delay. The actuator then updates the status to "Pump ON", providing that the condition for this has been fulfilled and an optionally configured "Pump delay ACTIVE" has elapsed.				

---

Function:	Pump control				
Object	Function	Name	Type	DPT	Flag
 <sup>3</sup>	External pump control	Pump - input	1-bit	1.001	C, W, -, (R) <sup>1</sup>
Description	1-bit input object for the cascading of multiple actuators with pump control. The transmitting operation for the pump control of another heating actuator can be connected to this object. The local heating actuator links the external telegram with the internal status of the pump logically as OR and outputs the result of this link via the object 2. In this case, the telegram polarity is fixed: "0" = Pump OFF, "1" = Pump ON. Cyclical telegrams to this object with an identical telegram polarity (ON -> ON, OFF -> OFF) produce no reaction. After a device reset, there is no polling of the current status of this object. Only when a bus telegram is received does the actuator take this status into account when activating the pump.				

1: For reading, the R-flag must be set. The last value written to the object via the bus will be read.

Function:	Evaluation of the largest command value				
Object	Function	Name	Type	DPT	Flag
 <sup>4</sup>	Largest command value	Valve outputs - Output	1 byte	5.001	C, -, T, R
Description	<p>1-byte output object for transmission of the largest constant command value of the heating actuator to another bus device (e.g. suitable calorific furnaces with integrated KNX controller or visualisation). The heating actuator evaluates all the active 1-byte command values of the valve outputs and, optionally, the externally received largest command value (object 5) and transmits the largest command value via this object.</p> <p>In the case of valve outputs configured in the ETS to the command value data formats "Switching (1-bit)" or "Constant (1-byte) with command value limiting value", there is no evaluation of the command values preset via the bus.</p> <p>Exception: It may also occur with such command value outputs that a constant command value is active (e.g. after bus/mains voltage return or a forced position and emergency operation or manual operation). In this case, this constant command value is also included in the calculation of the largest command value until the named functions with a higher priority are exited or a new command value telegram is received via the bus, overriding the constant command value at the valve output.</p> <p>After bus voltage return and an ETS programming operation, the actuator transmits the current value of the largest command value without a delay, providing that automatic transmission on change is configured. After a full device reset, the actuator does not transmit automatically, when all the command values are set to 0 %.</p> <p>After a device reset, the actuator immediately starts the time for cyclical transmission (if configured), so that the object value effective after the reset is transmitted cyclically.</p>				

Function:	Evaluation of the largest command value				
Object	Function	Name	Type	DPT	Flag
 <sup>5</sup>	External largest command value	Valve outputs - Input	1 byte	5.001	C, W, -, (R) <sub>1</sub>
Description	<p>1-bit input object for the cascading of multiple actuators with evaluation of the largest constant command value. The transmitting object of a largest command value of another heating actuator can be connected to this object. The local heating actuator monitors the external telegram with its own active constant command values and outputs the largest of all command values via object 4.</p> <p>Cyclical telegrams to this object with the same value cause no reaction. After a device reset, there is no polling of the current status of this object. Only when a bus telegram is received does the actuator take this status into account during evaluation.</p>				

1: For reading, the R-flag must be set. The last value written to the object via the bus will be read.

Function: Heat requirement signal

Object	Function	Name	Type	DPT	Flag
 <sup>6</sup>	Heat requirement	Valve outputs - Output	1-bit	1.002	C, -, T, R

Description 1-bit output object for the transmission of general heat requirement information to suitable burner and boiler controllers. A heat requirement is only signalled by the actuator when at least one command variable of the assigned outputs exceeds a limiting value with hysteresis defined in the ETS. A heat requirement signal is retracted when the limiting value is reached or undershot again. In addition, the actuator can optionally evaluate an external telegram (object 7).  
The telegram polarity can be configured. After bus voltage return and an ETS programming operation, the actuator always first transmits the status "No heat requirement" without a delay. The actuator then updates the status to "Heat requirement", providing that the condition for this has been fulfilled and an optionally configured "Heat requirement ACTIVE" has elapsed.

Function: Heat requirement signal

Object	Function	Name	Type	DPT	Flag
 <sup>7</sup>	External heat requirement	Valve outputs - Input	1-bit	1.002	C, W, -, (R) <sup>1</sup>

Description 1-bit input object for the cascading of multiple actuators with a heat requirement signal. The transmitting object of a heat requirement signal of another heating actuator can be connected to this object. The local heating actuator links the external telegram with the internal status of its own heat requirement logically as OR and outputs the result of this link via the object 6. In this case, the telegram polarity is fixed: "0" = Heat requirement INACTIVE, "1" = Heat requirement ACTIVE.  
Cyclical telegrams to this object with an identical telegram polarity (ON -> ON, OFF -> OFF) produce no reaction. After a device reset, there is no polling of the current status of this object. Only when a bus telegram is received does the actuator take this status into account during evaluation of the heat requirement.

Function: Toggling of the Summer / Winter operating mode

Object	Function	Name	Type	DPT	Flag
 <sup>8</sup>	Summer / winter change-over	Operating mode - input	1-bit	1.002	C, W, -, (R) <sub>1</sub>

Description 1-bit input object to switch over between summer and winter mode. The telegram polarity can be configured. The status is stored internally in the device if there is a bus or mains voltage failure and is restored after a device reset.  
Cyclical telegrams to this object with an identical telegram polarity (ON -> ON, OFF -> OFF) produce no reaction.

1: For reading, the R-flag must be set. The last value written to the object via the bus will be read.

Function: Short-circuit / overload signal

Object	Function	Name	Type	DPT	Flag
 <sup>9</sup>	Reset short-circuit / overload	Valve outputs - Input	1-bit	1.015	C, W, -, (R) <sub>1</sub>

Description: 1-bit input object for central reset of all short-circuit/overload signals of the valve outputs. In this case, the telegram polarity is fixed: "0" = No reaction, "1" = Reset all signals.  
Individual short-circuit / overload signals can only be reset via the object when the testing cycle (waiting time and testing cycle time) of the affected valve outputs has been completed.

Function: Collective feedback status

Object	Function	Name	Type	DPT	Flag
 <sup>10</sup>	Collective feedback status	Valve outputs - Output	4 byte	27.001	C, -, (T), (R) <sup>2</sup>

Description: 4-byte output object for collective status feedback of all valve outputs. The collective feedback summarises the valve states in just one telegram. The object contains bit-orientated feedback information. The object can be actively transmitting or passively read out (parameter-dependent).

Function: Activate / deactivate service mode

Object	Function	Name	Type	DPT	Flag
 <sup>12</sup>	Activate / deactivate	Service mode - input	2-bit	2,001	C, W, -, (R) <sub>1</sub>

Description: 2-bit input object for activating and deactivating service mode. With the value "1", bit 1 of the telegram activates service mode. The assigned valve outputs are then locked in the status preset by bit 0 ("0" = Closed / "1" = Opened). The configured valve direction of action is taken into account. The value "0" in bit 1 deactivates service mode again.  
0x = Service mode deactivated  
10 = Service mode activated, valves closed  
11 = Service mode activated, valves opened

Function: Service mode status

Object	Function	Name	Type	DPT	Flag
 <sup>13</sup>	Status active / inactive	Service mode - output	1-bit	1.002	C, -, T, R

Description: 1-bit output object for status signalling of whether the service mode is active or not. In this case, the telegram polarity is fixed: "0" = Service mode inactive, "1" = Service mode active.  
The object value is not transmitted automatically after a device reset (ETS programming operation, bus/mains voltage return).

1: For reading, the R-flag must be set. The last value written to the object via the bus will be read.

2: The communication flags are set automatically depending on the configuration. "T" flag for active signalling object; "R" flag for passive status object.

Function: Manual operation

Object	Function	Name	Type	DPT	Flag
 <sup>14</sup>	Disabling	Manual operation - input	1-bit	1.003	C, W, -, (R) <sup>1</sup>

Description 1-bit input object for disabling the buttons for manual operation on the device. The polarity can be configured.

Function: Manual operation

Object	Function	Name	Type	DPT	Flag
 <sup>15</sup>	Status	Manual operation - output	1-bit	1.002	C, -, T, R

Description 1-bit output object for manual operation status transmission. The object is "0", when manual control is deactivated (bus control). The object is "1", when manual operation is active. You can configure whether the temporary or the permanent manual operation will be indicated as status information or not.

1: For reading, the R-flag must be set. The last value written to the object via the bus will be read.

## 4.2.3.2 Objects for valve outputs

Function:		Command value presetting			
Object	Function	Name	Type	DPT	Flag
 20, 70, 120, 170, 220, 270	Command value	Valve output X - Input (X = 1...6)	1-bit	1.001	C, W, -, (R) 1
Description		<p>1-bit input object for the presetting of a switching command value, e.g. of a KNX room temperature controller. In this case, the telegram polarity is fixed: "0" = Close valve, "1" = Open valve. The configured valve direction of action is taken into account in the electrical activation of the valve.</p> <p>This object is only available for valve outputs configured in the ETS to the command value data format "Switching (1-bit)".</p>			

Function:		Command value presetting			
Object	Function	Name	Type	DPT	Flag
 21, 71, 121, 171, 221, 271	Command value	Valve output X - Input (X = 1...6)	1 byte	5.001	C, W, -, (R) 1
Description		<p>1-byte input object for the presetting of a constant command value, e.g. of a KNX room temperature controller (0...100 % -&gt; 0...255). This object is only available for valve outputs configured in the ETS to the command value data formats "Constant (1-bit) with pulse width modulation (PWM)" or "Constant (1-byte) with command value limiting value". With the command value format "Constant (1-byte) with pulse width modulation (PWM)", the telegram value is implemented by the actuator with an equivalent pulse-width-modulated switch signal at the valve outputs. The duty factor is adapted constantly by the actuator, depending on the command value received. The cycle time can be configured in the ETS. In accordance with the configured valve direction of action, the output is either energised or deenergised, depending on the valve position to be approached. In so doing, the duty factor is inverted automatically for a deenergised opened drive.</p> <p>In the command value format "Constant (1-byte) with command value limiting value", the received constant command value is converted into a switching output signal, depending on a configured limiting value. The actuator opens when the command value reaches the limiting value or exceeds it. A hysteresis is also evaluated to prevent constant closing and opening of the actuator for command values in the area of the limiting value. The actuator only closes when the command value undershoots the limiting value minus the configured hysteresis. The conversion of the constant input signal into a switching command value takes place internally in the device. During processing, the actuator evaluates the converted command value as if it were a received 1-bit command value. It forwards the status directly to the appropriate output, taking the configured valve direction of action into account.</p>			

1: For reading, the R-flag must be set. The last value written to the object via the bus will be read.

Function: Valve status

Object	Function	Name	Type	DPT	Flag
 22, 72, 122, 172, 222, 272	Feedback valve command value	Valve output X - Output (X = 1...6)	1-bit	1.001	C, -, T, R <sup>1</sup>

**Description** 1-bit output object to feed back the active switching command value of a valve output. In this case, the telegram polarity is fixed: "0" = Valve closed, "1" = Valve opened.  
 This object is only available for valve outputs configured in the ETS to the command value data formats "Switching (1-bit)" or "Constant (1-byte) with command value limiting value".  
 It may also occur with such command value outputs that a constant command value (PWM at the output) is active (e.g. after bus/mains voltage return or a forced position and emergency operation or manual operation). In this case, the status object feeds back a "0" if the command value corresponds to "0 %". The object sends back a "1" when the set command value corresponds to "1...100 %".  
 The object transmits the current status after bus voltage return and an ETS programming operation, possibly after a transmission delay (configurable) has elapsed.

Function: Valve status

Object	Function	Name	Type	DPT	Flag
 23, 73, 123, 173, 223, 273	Feedback valve command value	Valve output X - Output (X = 1...6)	1 byte	5.001	C, -, T, R <sup>1</sup>

**Description** 1-byte output object to feed back the active constant command value of a valve output (0...100 % -> 0...255).  
 This object is only available for valve outputs configured in the ETS to the command value data format "Constant (1-byte) with pulse width modulation (PWM)".  
 The object transmits the current status after bus voltage return and an ETS programming operation, possibly after a transmission delay (configurable) has elapsed.

Function: Valve forced position

Object	Function	Name	Type	DPT	Flag
 24, 74, 124, 174, 224, 274	Forced position	Valve output X - Input (X = 1...6)	1-bit	1.003	C, W, -, (R) 2

**Description** 1-bit input object for activating and deactivating of a forced position. The telegram polarity can be configured.  
 Updates of the object from "Forced position active" to "Forced position active" or from "Forced position inactive" to "Forced position inactive" produce no reaction. The status preset via the forced position object is stored internally in the device after a bus voltage failure and is restored automatically after a bus and/or mains voltage return.

1: The communication flags are set automatically depending on the configuration. "T" flag for active signalling object; "R" flag for passive status object.

2: For reading, the R-flag must be set. The last value written to the object via the bus will be read.



Function: Command value monitoring

Object	Function	Name	Type	DPT	Flag
 25, 75, 125, 175, 225, 275	Command value fault	Valve output X - Output (X = 1...6)	1-bit	1.005	C, -, T, R

Description 1-bit output object to signal a faulty command value (with active command value monitoring, no command value telegram was received within the monitoring time). The telegram polarity can be configured. Immediately after the bus voltage return or an ETS programming operation, the object "Command value fault" does not transmit the status automatically. A faulty command value must be detected again (expiry of the monitoring time without a command value telegram) for the object value to be transmitted. This is also the case if a saved emergency operation was restored after a device reset.

Function: Command value limit

Object	Function	Name	Type	DPT	Flag
 26, 76, 126, 176, 226, 276	Command value limit	Valve output X - Input (X = 1...6)	1-bit	1.002	C, W, -, (R) <sup>1</sup>

Description 1-bit input object for requirement-orientated activating and deactivating of a command value limit. The telegram polarity is fixed: "0" = Command value limit inactive, "1" = Command value limit active. Updates of the object from "1" to "1" or "0" to "0" do not produce a reaction. If required, this object is only available for valve outputs configured in the ETS to the command value data format "Constant (1-byte) with pulse width modulation (PWM)". It is possible to have the actuator activate the command value limit automatically after bus voltage return or an ETS programming operation. The status of the command value limit is not then automatically tracked in the communication object.

Function: Valve rinsing

Object	Function	Name	Type	DPT	Flag
 27, 77, 127, 177, 227, 277	Valve rinsing start Valve rinsing start / stop	Valve output X - Input (X = 1...6)	1-bit	1.003	C, W, -, (R) <sup>1</sup>

Description 1-bit input object for starting and stopping valve rinsing. Valve rinsing can be activated by time or an event using this object. It is also possible, for example, to cascade multiple heating actuators, so that they perform valve rinsing simultaneously (link of the individual status objects to the input objects of the valve rinsing). The telegram polarity can be configured. Stopping can be prevented via the object as an option. The time of cyclical valve rinsing is restarted as soon as an externally started valve rinsing operation is stopped by a Stop telegram or by the expiry of the rinsing time. Updates of the object from "Start" to "Start" or "Stop" to "Stop" do not produce a reaction. The length of an elapsing valve rinsing operation or the cycle time of the cyclical valve rinsing are not restarted by this.

1: For reading, the R-flag must be set. The last value written to the object via the bus will be read.

Function: Valve rinsing

Object	Function	Name	Type	DPT	Flag
 28, 78, 128, 178, 228, 278	Valve rinsing status	Valve output X - Output (X = 1...6)	1-bit	1.002	C, -, T, R

Description 1-bit output object for status feedback of a valve rinsing operation. The telegram polarity is fixed: "0" = Valve rinsing inactive, "1" = Valve rinsing active.  
The object transmits the current status after bus and mains voltage return and after an ETS programming operation without a delay.

Function: Overload / short-circuit identification

Object	Function	Name	Type	DPT	Flag
 29, 79, 129, 179, 229, 279	Signal short-circuit /overload	Valve output X - Output (X = 1...6)	1-bit	1.005	C, -, T, R

Description 1-bit output object to signal an identified overload or a short-circuit at the affected valve output. The telegram polarity can be configured.  
The object always transmits the current status after bus voltage return and an ETS programming operation after a delay, providing that a delay after bus voltage return has been configured on the "General" parameter page.

Function: Combined valve status

Object	Function	Name	Type	DPT	Flag
 30, 80, 130, 180, 230, 280	Feedback combined valve status	Valve output X - Output (X = 1...6)	1 byte	--- <sup>1</sup>	C, -, T, R <sup>2</sup>

Description 1-byte output object for combined feedback of various items of status information of a valve output. The bit coding is preset as follows:  
 Bit 0: Command value status ("0" = OFF, 0 % / "1" = ON, "1...100 %")  
 Bit 1: Short-circuit ("0" = No short-circuit / "1" = Short-circuit)  
 Bit 2: Overload ("0" = No overload / "1" = Overload)  
 Bit 3: Valve rinsing ("0" = No valve rinsing / "1" = Valve rinsing active)  
 Bit 4: Service mode ("0" = No service mode / "1" = Service mode active)  
 Bit 5: Manual operation ("0" = No manual op. / "1" Manual op. active)  
 Bit 6: Forced position ("0" = No forced position / "1" = Forced position active)  
 Bit 7: Not assigned (always "0")  
 The object transmits the current status after bus voltage return and an ETS programming operation, possibly after a transmission delay (configurable) has elapsed.

1: Non-standardised DP type.

2: The communication flags are set automatically depending on the configuration. "T" flag for active signalling object; "R" flag for passive status object.

Function: Operating hours counter

Object	Function	Name	Type	DPT	Flag
<input type="checkbox"/> ← 31, 81, 131, 181, 231, 281	Limit value / starting value operating hours counter <sup>1</sup>	Valve output X - Input (X = 1...6)	2 byte	7.007	C, W, -, (R) 2

Description 2-byte input object for external presetting of a limiting value / starting value of the operating hours counter of a valve output.  
Value range: 0...65535

Function: Operating hours counter

Object	Function	Name	Type	DPT	Flag
<input type="checkbox"/> ← 32, 82, 132, 182, 232, 282	Reset operating hours counter	Valve output X - Input (X = 1...6)	1-bit	1.015	C, W, -, (R) 2

Description 1-bit input object for resetting the operating hours counter of a valve output ("1" = Restart, "0" = No reaction).

Function: Operating hours counter

Object	Function	Name	Type	DPT	Flag
<input type="checkbox"/> ← 33, 83, 133, 183, 233, 283	Value operating hours counter	Valve output X - Output (X = 1...6)	2 byte	7.007	C, -, T, (R) 2

Description 2-byte output object to transmit or read out the current counter level of the operating hours counter of a valve output.  
If the bus voltage should fail, the value of the communication object is not lost and is actively transmitted to the bus after bus voltage return or an ETS programming operation. In the as-delivered state, the value is "0".

Function: Operating hours counter

Object	Function	Name	Type	DPT	Flag
<input type="checkbox"/> ← 34, 84, 134, 184, 234, 284	Op. hours counter elapsed	Valve output X - Output (X = 1...6)	1-bit	1.002	C, -, T, (R) 2

Description 1-bit output object to signal that the operating hours counter has elapsed (forwards counter = limiting value reached / backwards counter = value "0" reached). With a message, the object value is actively transmitted to the bus ("1" = message active / "0" = message inactive).  
If there is a device reset, the value of the communication object is not lost and is actively transmitted to the bus after bus voltage return or an ETS programming operation.

1: Threshold value object or start value object depending on the configured counter type of the operating hours counter.

2: For reading, the R-flag must be set. The last value written to the object via the bus will be read.

## 4.2.3.3 Objects for room temperature controllers

### Object for setpoint temperature specification

Function: Setpoint temperature specification					
Object	Function	Name	Type	DPT	Flag
 320, 391, 462, 533, 604, 675	Basic setpoint	Controller x - Input (x = 1...6)	2 bytes	9.001	C, W, -, (R) <sup>1</sup>
Description	2-byte object for external specification of the basic setpoint for <u>relative setpoint specification</u> . Depending on the operating mode, the possible range of values is limited by the configured frost protection and/or heat protection temperature. The controller rounds the temperature values received via the object depending on the configured interval of the basic setpoint shift (0.1 K or 0.5 K). The temperature value must always be specified in the format "°C".				

Function: Setpoint temperature specification					
Object	Function	Name	Type	DPT	Flag
 320, 391, 462, 533, 604, 675	Setpoint active operating mode	Controller x - Input (x = 1...6)	2 bytes	9.001	C, W, -, (R) <sup>1</sup>
Description	2-byte object for external setting of a setpoint for <u>absolute setpoint presetting</u> . Depending on the operating mode, the possible range of values is limited by the configured frost protection and/or heat protection temperature. The controller rounds the temperature values received via the object to 0.1 K. The temperature value must always be specified in the format "°C".				

### Objects for operating mode change-over

Function: Operating mode switchover					
Object	Function	Name	Type	DPT	Flag
 322, 393, 464, 535, 606, 677	Operating mode switchover	Controller x - Input (x = 1...6)	1 bytes	20.102	C, W, T, (R) <sup>2</sup>
Description	1-byte object for change-over of the operating mode of the controller according to the KNX specification. This object is only available in this way when the operating mode switchover is to take place over 1 byte (parameter-dependent). After bus voltage return or an ETS programming operation (controller reset), the current operating mode is transmitted via this object.				

1: For reading, the R-flag must be set. The last value written to the object via the bus will be read.

2: For reading, the R-flag must be set. The last value written to the object via the bus or by the device will be read.

Function: Operating mode switchover

Object	Function	Name	Type	DPT	Flag
 322, 393, 464, 535, 606, 677	Comfort mode	Controller x - Input (x = 1...6)	1-bit	1.001	C, W, T, (R) <sup>1</sup>

Description 1-bit object for change-over to the "Comfort" operating mode. This object is only available in this way when the operating mode change-over is to take place over 4 x 1 bit (parameter-dependent).  
After bus voltage return or an ETS programming operation (controller reset), the "Comfort" operating mode, if active, is transmitted via this object.

Function: Operating mode switchover

Object	Function	Name	Type	DPT	Flag
 323, 394, 465, 536, 607, 678	Standby mode	Controller x - Input (x = 1...6)	1-bit	1.001	C, W, T, (R) <sup>1</sup>

Description 1-bit object for change-over to the "Standby" operating mode. This object is only available in this way when the operating mode change-over is to take place over 4 x 1 bit (parameter-dependent).  
After bus voltage return or an ETS programming operation (controller reset), the "Standby" operating mode, if active, is transmitted via this object.

Function: Operating mode switchover

Object	Function	Name	Type	DPT	Flag
 324, 395, 466, 537, 608, 679	Night operation	Controller x - Input (x = 1...6)	1-bit	1.001	C, W, T, (R) <sup>1</sup>

Description 1-bit object for change-over to the "Night" operating mode. This object is only available in this way when the operating mode change-over is to take place over 4 x 1 bit (parameter-dependent).  
After bus voltage return or an ETS programming operation (controller reset), the "Night operation" operating mode, if active, is transmitted via this object.

Function: Operating mode switchover

Object	Function	Name	Type	DPT	Flag
 325, 396, 467, 538, 609, 680	Frost/ heat protection	Controller x - Input (x = 1...6)	1-bit	1.001	C, W, T, (R) <sup>1</sup>

Description 1-bit object for change-over to the "Frost / heat protection" operating mode. This object is only available in this way when the operating mode change-over is to take place over 4 x 1 bit (parameter-dependent).  
After bus voltage return or an ETS programming operation (controller reset), the "Frost / heat protection" operating mode, if active, is transmitted via this object.

1: For reading, the R-flag must be set. The last value written to the object via the bus or by the device will be read.

Function: Operating mode switchover

Object	Function	Name	Type	DPT	Flag
<input type="checkbox"/> ← 326, 397, 468, 539, 610, 681	Operating mode forced-control	Controller x - Input (x = 1...6)	1 bytes	20.102	C, W, T, (R) <sup>1</sup>

Description 1-byte object for forced change-over (highest priority) of the operating mode of the controller according to the KNX specification. This object is only available in this way when the operating mode switchover is to take place over 1 byte (parameter-dependent).

Function: Operating mode change-over presence detection

Object	Function	Name	Type	DPT	Flag
<input type="checkbox"/> ← 327, 398, 469, 540, 611, 682	Presence button	Controller x - Input (x = 1...6)	1-bit	1.001	C, W, T, (R) <sup>1</sup>

Description 1-bit object through which an external presence button (e.g. from a controller extension) can be linked to the controller (polarity: Presence exists = "1", no presence exists = "0").  
 Presence allows permanent switching to Comfort mode (starting in Standby mode) or temporary switching to this Comfort extension (starting from Night mode or Frost / heat protection mode).  
 Presence in Standby mode: If there is a presence, the controller activates Comfort mode. As soon as the object no longer signals a presence, the controller switches back to Standby mode.  
 Presence in Night mode or Frost / heat protection mode: If there is a presence, the controller activates the Comfort extension. After the configured length of the Comfort extension has elapsed, the system automatically switches back to Night mode or Frost / heat protection mode. In this case, the object value is reset automatically.  
 After a bus voltage return or an ETS programming operation (controller reset), the presence function is always inactive.  
 This object is only visible if the presence detection is configured to "Presence button".

Function: Operating mode change-over presence detection

Object	Function	Name	Type	DPT	Flag
<input type="checkbox"/> ← 327, 398, 469, 540, 611, 682	Presence detector	Controller x - Input (x = 1...6)	1-bit	1.001	C, W, T, (R) <sup>1</sup>

Description 1-bit object through which an external KNX presence detector can be linked to the controller (polarity: Presence exists = "1", no presence exists = "0").  
 If there is a presence, the controller activates Comfort mode, provided that no higher-level function (e.g. window status) is active. The controller switches to the last specified operating mode as soon as the presence detector ceases to signal a presence.  
 After a bus voltage return or an ETS programming operation (controller reset), the presence function is always inactive.  
 This object is only visible if the presence detection is configured to "Presence detector".

1: For reading, the R-flag must be set. The last value written to the object via the bus or by the device will be read.

Function: Operating mode change-over window status

Object	Function	Name	Type	DPT	Flag
 328, 399, 470, 541, 612, 683	Window status	Controller x - Input (x = 1...6)	1-bit	1.019	C, W, -, (R) 1

Description 1-bit object for the coupling of window contacts.  
Polarity: Window open = "1", window closed = "0".

### Object for operating mode change-over

Function: Operating mode change-over

Object	Function	Name	Type	DPT	Flag
 329, 400, 471, 542, 613, 684	Heating / cooling change-over	Controller x - Output (x = 1...6)	1-bit	1.100	C, -, T, (R) 2

Description 1 bit object to transmit the automatically set operating mode of the controller ("Heating" or "Cooling" modes).  
Object value "1" = Heating; Object value "0" = Cooling.  
After bus voltage return or an ETS programming operation (controller reset), the current operating mode is transmitted via this object. This object is only available in this way when the operating mode switchover is to take place automatically (parameter-dependent).

Function: Operating mode change-over

Object	Function	Name	Type	DPT	Flag
 329, 400, 471, 542, 613, 684	Heating / cooling change-over	Controller x - Input (x = 1...6)	1-bit	1.100	C, W, T, (R) 2

Description 1 bit object to change-over the operating mode of the controller ("Heating" or "Cooling" modes). Object value "1" = Heating; Object value "0" = Cooling.  
After a bus voltage return or ETS programming operation (controller reset), the object value is always "0", irrespective of which operating mode is specified via configuration after a reset. This object is only available in this way when the operating mode change-over is to take place manually (not automatically by the controller) (parameter-dependent).

1: For reading, the R-flag must be set. The last value written to the object via the bus will be read.

2: For reading, the R-flag must be set. The last value written to the object via the bus or by the device will be read.

## Objects for controller status

Function: Status signal

Object	Function	Name	Type	DPT	Flag
<input type="checkbox"/> ← 330, 401, 472, 543, 614, 685	KNX status operating mode	Controller x - Output (x = 1...6)	1 bytes	20.102	C, -, T, (R) <sup>1</sup>

**Description** 1-byte object used by the controller to output the current operating mode. This object is generally used to enable controller extensions to display the controller operating mode correctly in the KNX compliant status display. Therefore this object should be connected with controller extensions if the KNX compliant status feedback is not configured.  
After bus voltage return or an ETS programming operation (controller reset), the current status is transmitted via this object. This object is only available when "Controller status" = "KNX-compliant".

Function: Status signal

Object	Function	Name	Type	DPT	Flag
<input type="checkbox"/> ← 330, 401, 472, 543, 614, 685	Controller status	Controller x - Output (x = 1...6)	1 bytes	---	C, -, T, (R) 1

**Description** 1-byte object used by the controller to output the current state of operation (e.g. to a controller extension).  
After bus voltage return or an ETS programming operation (controller reset), the current status is transmitted via this object. This object is only available when "Controller status" = "General controller".

Function: Status signal

Object	Function	Name	Type	DPT	Flag
<input type="checkbox"/> ← 330, 401, 472, 543, 614, 685	Controller status ...	Controller x - Output (x = 1...6)	1-bit	1.001	C, -, T, (R) 1

**Description** 1-bit object for single status feedback of configured controller functions. This object is only available in this way when a part of the controller status is to be transmitted singly as 1-bit information (parameter-dependent).  
After bus voltage return or an ETS programming operation (controller reset), the current status is transmitted via this object.

1: For reading, the R-flag must be set. The last value written to the object via the bus or by the device will be read.



Function: Status signal

Object	Function	Name	Type	DPT	Flag
 338, 409, 480, 551, 622, 693	KNX status	Controller x - Output (x = 1...6)	2 bytes	22.101	C, -, T, (R) <sup>1</sup>

Description 2-byte object that the controller uses to display elementary basic functions in a KNX-harmonised manner.  
After bus voltage return or an ETS programming operation (controller reset), the current status is transmitted via this object. This object is only available when "Controller status" = "KNX-compliant".

Function: Status signal

Object	Function	Name	Type	DPT	Flag
 338, 409, 480, 551, 622, 693	Status signal addition	Controller x - Output (x = 1...6)	1 bytes	---	C, -, T, (R) 1

Description 1-byte object used by the controller to output the current enlarged state of operation (e.g. to a controller extension).  
After bus voltage return or an ETS programming operation (controller reset), the current status is transmitted via this object. This object is only available when "Controller status" = "General controller".

Function: Status signal

Object	Function	Name	Type	DPT	Flag
 339, 410, 481, 552, 623, 694	KNX status forced oper. mode	Controller x - Output (x = 1...6)	1 bytes	20.102	C, -, T, (R) <sup>1</sup>

Description 1-byte object used by the controller to output the operating mode in the event of forced position. This object is generally used to enable controller extensions to display the controller operating mode correctly in the KNX compliant status display. Therefore this object should be connected with controller extensions if the KNX compliant status feedback is not configured.  
After bus voltage return or an ETS programming operation (controller reset), the current status is transmitted via this object. This object is only available when "Controller status" = "KNX-compliant".

1: For reading, the R-flag must be set. The last value written to the object via the bus or by the device will be read.

## Objects for heating / cooling signal functions

Function: Heating energy message

Object	Function	Name	Type	DPT	Flag
 371, 442, 513, 584, 655, 726	Heating indication	Controller x - Output (x = 1...6)	1-bit	1.001	C, -, T, (R) 1

Description 1-bit object for the controller to report a request for heating energy. Object value = "1": energy request, object value = "0": no energy request.

Function: Cooling energy message

Object	Function	Name	Type	DPT	Flag
 372, 443, 514, 585, 656, 727	Cooling indication	Controller x - Output (x = 1...6)	1-bit	1.001	C, -, T, (R) 1

Description 1-bit object for the controller to report a request for cooling energy. Object value = "1": energy request, object value = "0": no energy request.

## Objects for controller disabling functions

Function: Disable controller

Object	Function	Name	Type	DPT	Flag
 355, 426, 497, 568, 639, 710	Disable controller	Controller x - Input (x = 1...6)	1-bit	1.001	C, W, -, (R) 2

Description 1-bit object for deactivating the controller (activating dew point operation). Polarity: Controller deactivated = "1", controller activated = "0". This object is only available if controller switch-off via the bus is enabled.

Function: Disable controller

Object	Function	Name	Type	DPT	Flag
 356, 427, 498, 569, 640, 711	Disable additional level	Controller x - Input (x = 1...6)	1-bit	1.001	C, W, -, (R) 2

Description 1-bit object for deactivating the additional level of the controller. Polarity: Additional level deactivated = "1", additional level activated = "0". This object is only available in this way if two-level heating or cooling operation is configured.

1: For reading, the R-flag must be set. The last value written to the object via the bus or by the device will be read.

2: For reading, the R-flag must be set. The last value written to the object via the bus will be read.

## Object for heating command value output and combined valve heating/cooling

Function: Command value

Object	Function	Name	Type	DPT	Flag
 357, 428, 499, 570, 641, 712	Command value for heating / command value, basic heating	Controller x - Output (x = 1...6)	1 bytes	5.001	C, -, T, (R) 1

Description 1-byte object to output the continuous command value of the heating mode. In two-level heating mode, command value output for the basic heating. This object is only available in this way if the type of feedback control is configured to "Continuous PI control".

Function: Command value

Object	Function	Name	Type	DPT	Flag
 357, 428, 499, 570, 641, 712	Command value for heating (PWM) / command value, basic heating (PWM)	Controller x - Output (x = 1...6)	1-bit	1.001	C, -, T, (R) 1

Description 1-bit object to output the PWM command value of the heating mode. In two-level heating mode, command value output for the basic heating. This object is only available in this way if the type of feedback control is configured to "Switching PI control (PWM)".

Function: Command value

Object	Function	Name	Type	DPT	Flag
 357, 428, 499, 570, 641, 712	Command value for heating / command value, basic heating	Controller x - Output (x = 1...6)	1-bit	1.001	C, -, T, (R) 1

Description 1-bit object to output the switching command value of the heating mode. In two-level heating mode, command value output for the basic heating. This object is only available in this way if the type of feedback control is configured to "Switching 2-point feedback control".

Function: Command value

Object	Function	Name	Type	DPT	Flag
 357, 428, 499, 570, 641, 712	Command value for heating/cooling / command value, basic level	Controller x - Output (x = 1...6)	1 bytes	5.001	C, -, T, (R) 1

Description 1-byte object to output the combined continuous command value of the heating and cooling mode. In two-level heating/cooling mode, command value output for the basic level. This object is only available in this way if the command values for heating and cooling mode are output to a shared object (parameter-dependent). The type of feedback control must also be configured to "Continuous PI control".

1: For reading, the R-flag must be set. The last value written to the object via the bus or by the device will be read.

Function: Command value					
Object	Function	Name	Type	DPT	Flag
 357, 428, 499, 570, 641, 712	Command value for heating/cooling (PWM) / command value, basic level (PWM)	Controller x - Output (x = 1...6)	1-bit	1.001	C, -, T, (R) 1

**Description** 1-bit object to output the combined PWM command value of the heating and cooling mode. In two-level heating/cooling mode, command value output for the basic level This object is only available in this way if the command values for heating and cooling mode are output to a shared object (parameter-dependent). The type of feedback control must also be configured to "Switching PI control (PWM)".

Function: Command value					
Object	Function	Name	Type	DPT	Flag
 357, 428, 499, 570, 641, 712	Command value for heating/cooling / command value, basic level	Controller x - Output (x = 1...6)	1-bit	1.001	C, -, T, (R) 1

**Description** 1-bit object to output the combined switching command value of the heating and cooling mode. In two-level heating/cooling mode, command value output for the basic level This object is only available in this way if the command values for heating and cooling mode are output to a shared object (parameter-dependent). The type of feedback control must also be configured to "Switching 2-point feedback control".

### Object for command value output, additional heating and combined valve additional heating/cooling

Function: Command value					
Object	Function	Name	Type	DPT	Flag
 358, 429, 500, 571, 642, 713	Cmd. value, additional heating	Controller x - Output (x = 1...6)	1 bytes	5.001	C, -, T, (R) 1

**Description** 1-byte object to output the continuous command value for additional heating in two-level operation. This object is only available in this way if the type of feedback control is configured to "Continuous PI control".

Function: Command value					
Object	Function	Name	Type	DPT	Flag
 358, 429, 500, 571, 642, 713	Cmd. value, add. heating (PWM)	Controller x - Output (x = 1...6)	1-bit	1.001	C, -, T, (R) 1

**Description** 1-bit object to output the continuous PWM command value for additional heating in two-level operation. This object is only available in this way if the type of feedback control is configured to "Switching PI control (PWM)".

1: For reading, the R-flag must be set. The last value written to the object via the bus or by the device will be read.

Function:	Command value				
Object	Function	Name	Type	DPT	Flag
 358, 429, 500, 571, 642, 713	Cmd. value, additional heating	Controller x - Output (x = 1...6)	1-bit	1.001	C, -, T, (R) 1
Description	1-byte object to output the switching command value for additional heating in two-level operation. This object is only available in this way if the type of feedback control is configured to "Switching 2-point feedback control".				

Function:	Command value				
Object	Function	Name	Type	DPT	Flag
 358, 429, 500, 571, 642, 713	Cmd. value, add. level	Controller x - Output (x = 1...6)	1 bytes	5.001	C, -, T, (R) 1
Description	1-byte object to output the combined continuous command value for additional level in two-level operation. This object is only available in this way if the command values for heating and cooling mode are output to a shared object (parameter-dependent). The type of feedback control must also be configured to "Continuous PI control".				

Function:	Command value				
Object	Function	Name	Type	DPT	Flag
 358, 429, 500, 571, 642, 713	Cmd. value, add. level (PWM)	Controller x - Output (x = 1...6)	1-bit	1.001	C, -, T, (R) 1
Description	1-bit object to output the combined switching PWM command value for additional level in two-level operation. This object is only available in this way if the command values for heating and cooling mode are output to a shared object (parameter-dependent). The type of feedback control must also be configured to "Switching PI control (PWM)".				

Function:	Command value				
Object	Function	Name	Type	DPT	Flag
 358, 429, 500, 571, 642, 713	Cmd. value, add. level	Controller x - Output (x = 1...6)	1-bit	1.001	C, -, T, (R) 1
Description	1-bit object to output the combined switching command value for additional level in two-level operation. This object is only available in this way if the command values for heating and cooling mode are output to a shared object (parameter-dependent). The type of feedback control must also be configured to "Switching 2-point feedback control".				

1: For reading, the R-flag must be set. The last value written to the object via the bus or by the device will be read.

## Object for command value output, cooling

Function:		Command value				
Object	Function	Name	Type	DPT	Flag	
 359, 430, 501, 572, 643, 714	Command value cooling / Command value basic cooling	Controller x - Output (x = 1...6)	1 bytes	5.001	C, -, T, (R) 1	
Description		1-byte object to output the continuous command value of the cooling mode. In two-level cooling mode, command value output for the basic cooling. This object is only available in this way if the type of feedback control is configured to "Continuous PI control".				

Function:		Command value				
Object	Function	Name	Type	DPT	Flag	
 359, 430, 501, 572, 643, 714	Command value cooling (PWM) / Command value basic cooling (PWM)	Controller x - Output (x = 1...6)	1-bit	1.001	C, -, T, (R) 1	
Description		1-bit object to output the PWM command value of the cooling mode. In two-level cooling mode, command value output for the basic cooling. This object is only available in this way if the type of feedback control is configured to "Switching PI control (PWM)".				

Function:		Command value				
Object	Function	Name	Type	DPT	Flag	
 359, 430, 501, 572, 643, 714	Command value cooling / Command value basic cooling	Controller x - Output (x = 1...6)	1-bit	1.001	C, -, T, (R) 1	
Description		1-bit object to output the switching command value of the cooling mode. In two-level cooling mode, command value output for the basic cooling. This object is only available in this way if the type of feedback control is configured to "Switching 2-point feedback control".				

## Object for command value output, additional cooling

Function:		Command value				
Object	Function	Name	Type	DPT	Flag	
 360, 431, 502, 573, 644, 715	Cmd. value, additional cooling	Controller x - Output (x = 1...6)	1 bytes	5.001	C, -, T, (R) 1	
Description		1-byte object to output the continuous command value for additional cooling in two-level operation. This object is only available in this way if the type of feedback control is configured to "Continuous PI control".				

1: For reading, the R-flag must be set. The last value written to the object via the bus or by the device will be read.

Function:		Command value			
Object	Function	Name	Type	DPT	Flag
 360, 431, 502, 573, 644, 715	Cmd. value, add. cooling (PWM)	Controller x - Output (x = 1...6)	1-bit	1.001	C, -, T, (R) 1
Description		1-bit object to output the continuous PWM command value for additional cooling in two-level operation. This object is only available in this way if the type of feedback control is configured to "Switching PI control (PWM)".			

Function:		Command value			
Object	Function	Name	Type	DPT	Flag
 360, 431, 502, 573, 644, 715	Cmd. value, additional cooling	Controller x - Output (x = 1...6)	1-bit	1.001	C, -, T, (R) 1
Description		1-byte object to output the switching command value for additional cooling in two-level operation. This object is only available in this way if the type of feedback control is configured to "Switching 2-point feedback control".			

**Object for additional PWM heating command value output and combined valve PWM additional heating/cooling**

Function:		Command value			
Object	Function	Name	Type	DPT	Flag
 361, 432, 503, 574, 645, 716	PWM command value for heating / PWM command value, basic heating	Controller x - Output (x = 1...6)	1 bytes	5.001	C, -, T, (R) 1
Description		1-byte object to output the internal continuous command value of a PWM controller of the heating mode. In two-level heating mode, command value output for the basic heating. This object is only available in this way if the type of feedback control is configured to "Switching PI control (PWM)". In addition to the switching 1 bit command value of the PWM, the calculated continuous command value of the controller can also be transmitted to the bus and displayed, e.g. in a visualisation.			

1: For reading, the R-flag must be set. The last value written to the object via the bus or by the device will be read.

Function: Command value					
Object	Function	Name	Type	DPT	Flag
<input type="checkbox"/> ← 361, 432, 503, 574, 645, 716	PWM command value for heating/cooling / PWM command value, basic level	Controller x - Output (x = 1...6)	1 bytes	5.001	C, -, T, (R) 1

**Description** 1-byte object to output the combined continuous command value of a PWM controller of the heating and cooling mode. In two-level heating/cooling mode, command value output for the basic level This object is only available in this way if the command values for heating and cooling mode are output to a shared object (parameter-dependent). The type of feedback control must also be configured to "Switching PI control (PWM)". In addition to the switching 1 bit command value of the PWM, the calculated continuous command value of the controller can also be transmitted to the bus and displayed, e.g. in a visualisation.

**Object for additional command value output, PWM additional heating and combined valve PWM additional heating/cooling**

Function: Command value					
Object	Function	Name	Type	DPT	Flag
<input type="checkbox"/> ← 362, 433, 504, 575, 646, 717	PWM com. value, add. heating	Controller x - Output (x = 1...6)	1 bytes	5.001	C, -, T, (R) 1

**Description** 1-byte object to output the internal continuous command value of a PWM controller for additional heating in two-level operation. This object is only available in this way if the type of feedback control is configured to "Continuous PI control". In addition to the switching 1 bit command value of the PWM, the calculated continuous command value of the controller can also be transmitted to the bus and displayed, e.g. in a visualisation.

Function: Command value					
Object	Function	Name	Type	DPT	Flag
<input type="checkbox"/> ← 362, 433, 504, 575, 646, 717	PWM command value, add. level	Controller x - Output (x = 1...6)	1 bytes	5.001	C, -, T, (R) 1

**Description** 1-byte object to output the combined continuous command value of a PWM feedback controller for additional level in two-level operation. This object is only available in this way if the command values for heating and cooling mode are output to a shared object (parameter-dependent). The type of feedback control must also be configured to "Switching PI control (PWM)". In addition to the switching 1 bit command value of the PWM, the calculated continuous command value of the controller can also be transmitted to the bus and displayed, e.g. in a visualisation.

1: For reading, the R-flag must be set. The last value written to the object via the bus or by the device will be read.



## Object for additional command value output, PWM cooling

Function: Command value

Object	Function	Name	Type	DPT	Flag
 363, 434, 505, 576, 647, 718	PWM command value cooling / PWM command value basic cooling	Controller x - Output (x = 1...6)	1 bytes	5.001	C, -, T, (R) 1

**Description** 1-byte object to output the internal continuous command value of a PWM feedback controller of the cooling mode. In two-level cooling mode, command value output for the basic cooling. This object is only available in this way if the type of feedback control is configured to "Switching PI control (PWM)". In addition to the switching 1 bit command value of the PWM, the calculated continuous command value of the controller can also be transmitted to the bus and displayed, e.g. in a visualisation.

## Object for additional command value output, PWM additional cooling

Function: Command value

Object	Function	Name	Type	DPT	Flag
 364, 435, 506, 577, 648, 719	PWM com. value, add. cooling	Controller x - Output (x = 1...6)	1 bytes	5.001	C, -, T, (R) 1

**Description** 1-byte object to output the internal continuous command value of a PWM feedback controller for additional cooling in two-level operation. This object is only available in this way if the type of feedback control is configured to "Switching PI control (PWM)". In addition to the switching 1 bit command value of the PWM, the calculated continuous command value of the controller can also be transmitted to the bus and displayed, e.g. in a visualisation.

## Object for outputting the setpoint temperature

Function: Set temperature

Object	Function	Name	Type	DPT	Flag
 334, 405, 476, 547, 618, 689	Set temperature	Controller x - Output (x = 1...6)	2 bytes	9.001	C, -, T, R

**Description** 2-byte object for the output of the current temperature setpoint. Depending on the operating mode, the possible range of values is limited by the configured frost protection and/or heat protection temperature. The temperature value is always output in the format "°C". After bus voltage return or an ETS programming operation (controller reset), the current setpoint temperature is transmitted via this object.

1: For reading, the R-flag must be set. The last value written to the object via the bus or by the device will be read.

**Object for basic setpoint shift (only for relative setpoint presetting)**

Function: Basic setpoint shifting

Object	Function	Name	Type	DPT	Flag
 336, 407, 478, 549, 620, 691	Current setpoint shifting	Controller x - Output (x = 1...6)	1 bytes	6.010	C, -, T, R

**Description** 1-byte object for giving feedback on the current setpoint shift for evaluation, e.g. by a controller extension. The value of a counter value in the communication object is dependent on the parameter "Setpoint shift step width" and is either 0.1 or 0.5 K. The value "0" means that no shift is active. The value is depicted in a double complement in the positive and negative direction.  
 After bus voltage return or an ETS programming operation (controller reset), the current value for the basic setpoint shift is transmitted via this object. Since the value for the basic setpoint shift is stored exclusively in volatile memory, the shift is always "0" immediately after a bus voltage return or an ETS programming operation.  
 This object is only available in this way if relative setpoint presetting is configured.

Function: Basic setpoint shifting

Object	Function	Name	Type	DPT	Flag
 337, 408, 479, 550, 621, 692	Preset setpoint shifting	Controller x - Input (x = 1...6)	1 bytes	6.010	C, W, -, (R) 1

**Description** 1-byte object for setting a basic setpoint shifting, e.g. via a controller extension. The value of a counter value in the communication object is dependent on the parameter "Setpoint shift step width" and is either 0.1 or 0.5 K. The value "0" means that no shift is active. The value is depicted in a double complement in the positive and negative direction.  
 In case the limits of the value range are exceeded by the preset external value, the controller will automatically reset the received value to the minimum and maximum limits.  
 This object is only available in this way if relative setpoint presetting is configured.

1: For reading, the R-flag must be set. The last value written to the object via the bus will be read.

## Object for detecting the outdoor temperature

Function: Outdoor temperature

Object	Function	Name	Type	DPT	Flag
 340, 411, 482, 553, 624, 695	Outdoor temperature	Controller x - Input (x = 1...6)	2 bytes	9.001	C, W, -, (R) 1

Description 2-byte object for detecting the outdoor temperature The received value is used solely for limiting the setpoint temperature in cooling mode.  
Possible range of values: -99.9 °C to +99.9 °C.  
The temperature value must always be specified in the format "°C".

## Object for limiting the setpoint temperature

Function: Setpoint temperature limit

Object	Function	Name	Type	DPT	Flag
 341, 412, 483, 554, 625, 696	Limit of cooling setpoint temperature	Controller x - Input (x = 1...6)	1-bit	1.001	C, W, -, (R) 1

Description 1-bit object for activating the setpoint temperature limit. Polarity:  
Setpoint temperature limit ON = "1"; Setpoint temperature limit OFF = "0".  
This communication object is only available when the setpoint temperature  
limit intends activation via an object.

## Object for limiting the floor temperature

Function: Floor temperature limitation

Object	Function	Name	Type	DPT	Flag
 367, 438, 509, 580, 651, 722	Floor temperature	Controller x - Input (x = 1...6)	2 bytes	9.001	C, W, -, (R) 1

Description 2-byte object for coupling an external temperature sensor for floor temperature  
limitation.  
The temperature value must always be specified in the format "°C".

1: For reading, the R-flag must be set. The last value written to the object via the bus will be read.

## Objects for room temperature measurement

Function: Room temperature measurement

Object	Function	Name	Type	DPT	Flag
 381, 452, 523, 594, 665, 736	Actual-temperature	Controller x - Output (x = 1...6)	2 bytes	9.001	C, -, T, R

Description 2-byte object for the display of the actual temperature active in the controller (room temperature). The possible temperature range is specified by the received temperature values and corresponds to the range specified by the KNX DPT 9.001.  
The temperature value is always output in the format "°C".

Function: Room temperature measurement

Object	Function	Name	Type	DPT	Flag
 382, 453, 524, 595, 666, 737	Received temperature 1 (temperature sensor 1)	Controller x - Input (x = 1...6)	2 bytes	9.001	C, W, -, (R) 1

Description 2-byte object for coupling an external KNX temperature sensor (e.g. push-button sensor with temperature measurement) for room temperature detection. The possible temperature range is specified by the KNX DPT 9.001.  
The temperature value must always be specified in the format "°C".

Function: Room temperature measurement

Object	Function	Name	Type	DPT	Flag
 383, 454, 525, 596, 667, 738	Received temperature 2 (temperature sensor 2)	Controller x - Input (x = 1...6)	2 bytes	9.001	C, W, -, (R) 1

Description 2-byte object for coupling a further external KNX temperature sensor (e.g. push-button sensor with temperature measurement) for room temperature detection. Thus cascading of multiple temperature sensors for room temperature measurement. The possible temperature range is specified by the KNX DPT 9.001.  
The temperature value must always be specified in the format "°C".  
This communication object is only available when the second temperature sensor is enabled.

1: For reading, the R-flag must be set. The last value written to the object via the bus will be read.

## 4.2.4 Functional description

### 4.2.4.1 Description of channel-independent functions

#### 4.2.4.1.1 Parameter configuration

To simplify the configuration, all the valve outputs can be assigned to the same parameters in the ETS and thus configured identically. The parameter "Setting of the output parameters" on the parameter page "General" specifies whether every valve output of the device can be configured individually or whether all the outputs should be configured by the same parameters.

In the "All outputs equal" setting, the number of parameters in the ETS is reduced. The visible parameters are then used on all the valve outputs automatically. Only the communication objects can then be configured separately for the outputs. This setting should be selected, for example, if all the actuators behave identically and should only be activated by different group addresses (e.g. in office blocks or in hotel rooms).

In the parameter setting "Each output individually", each valve output possesses its own parameter pages in the ETS.

## 4.2.4.1.2 Priorities

The heating actuator distinguishes between various functions and events, which either affect all of some of the assigned valve drives globally, or only specifically affect individual outputs. Because these functions and events cannot be executed simultaneously, there must be priority control. Each global or output-orientated function and each incoming event possesses a priority. The function or the event with the higher priority overrides the lower-priority functions and events.

The following priorities are defined...

- Overload / short-circuit (highest priority)
- Manual operation
- Behaviour after ETS programming
- Behaviour in case of mains or bus voltage return / bus voltage failure
- Service mode
- Valve rinsing
- Forced position
- Command value limit
- Emergency operation (through cyclical monitoring of the command value)
- Normal operation (activation using command value telegrams)

- i** The behaviour after an ETS programming operation is only executed if there have been changes in the configuration of the device. If just an application download is executed with a project design already located in the actuator, then the actuator will execute the behaviour after bus voltage return.

In manual operation and in service mode, a parameter separately defines the behaviour of each of the valve outputs at the end of these functions. The heating actuator only then executes the configured behaviour if, at the time of enabling, no function with a lower priority is active. Should a lower-level function be active (e.g. forced position), then the actuator will execute the behaviour of this function again.

- i** Special case: A function with a higher priority (e.g. manual operation) is active. Before this, a function with a lower priority (e.g. service mode) was active. This function is deactivated whilst the higher-level function remains active. At the end of the higher-priority function, the state of the outputs should be tracked. The actuator then evaluates the command value of the lower-level function and checks how the behaviour is preset or configured here. The actuator then executes the command value presetting of the lower-level function. If tracking is also preset or configured for this function, the actuator will still go one layer lower and evaluate the behaviour configured there.

Example 1: Service mode is active (valve completely opened / 100 % command value). A value of 10 % was most recently preset via a command value telegram (normal operation). No other functions are active. Service mode is configured in such a way that the starting state should be tracked at the end of this function.

Permanent manual operation is now activated. The actuator assumes the command value of manual operation (e.g. 50 %). Whilst manual operation is active, service mode is deactivated via the KNX. The actuator remains in manual operation until this is exited via the button field. As no more lower-level functions are active, the heating actuator evaluates the parameter "Behaviour at the end of permanent manual operation during bus operation". As this parameter is set to "Track outputs", the actuator now evaluates the command value to be tracked. For this, it checks how the behaviour at the end of service mode is preset. Here too, the state should be tracked. Thus, the actuator evaluates the other lower-level functions. As no other functions were and are activated, the actuator sets the last command value presetting at the valve output using the KNX telegram (here 10 %).

Example 2: Service mode is active (valve completely opened / 100 % command value). A value of 10 % was most recently preset via a command value telegram (normal operation). No other functions are active. Service mode is configured in such a way that no change should be executed at the end of this function.

Permanent manual operation is now activated. The actuator assumes the command value of manual operation (e.g. 50 %). Whilst manual operation is active, service mode is deactivated via the KNX. The actuator remains in manual operation until this is exited via the button field. As no more lower-level functions are active, the heating actuator evaluates the parameter "Behaviour at the end of permanent manual operation during bus operation". As this parameter is set to "Track outputs", the actuator now evaluates the command value to be tracked. For this, it checks how the behaviour at the end of service mode is preset. There, the configuration states that there should be no change. Thus, the heating actuator for the affected valve output assumes the command value of service mode (here 100 %) and sets this at the output. In this case, the actuator no longer evaluates other lower-level functions.

### 4.2.4.1.3 Manual operation

All the valve outputs of the device have electronic manual operation. The button field with 4 function keys and 3 status LEDs on the front panel of the device can be used for setting the following modes of operation...

- Bus operation: Operation via room temperature controllers, push-buttons, or other bus devices,
- Temporary manual operation : Manual operation locally with keypad, automatic return to bus operation,
- Permanent manual operation: Exclusively manual operation on the device (e.g. construction site mode, commissioning phase).

The operation of the function keys, the activation of the valve outputs and the status display are described in detail in chapter "Operation" (see page 14). The configuration, status feedback, disabling via bus operation, and interaction with other functions of the device when manual operation is activated and deactivated are described in greater detail below.

Manual control is possible while the device is supplied with power from the mains or bus. In the state as supplied the manual control mode is fully enabled. In this unprogrammed state, all the outputs can be controlled by manual operation, so that fast function checking of the connected valve drives (e.g. on the construction site) is possible.

After initial commissioning of the actuator via the ETS, manual control can be enabled or disabled separately for various states of operation. Manual control can, for instance, be disabled during bus operation (bus voltage applied). Another option consists in the complete disabling of the manual control only in case of bus voltage failure. Therefore manual control can be disabled completely, if the bus disable and bus failure disable are active.

#### Enabling the manual control mode

Manual control for the different states of operation is enabled or disabled by means of the parameters "Manual control in case of bus voltage failure" and "Manual control during bus operation".

- Set the parameter "Manual control in case of bus voltage failure" to "enabled".  
Manual control is then basically enabled when the bus voltage is off. This setting corresponds to the setting of the actuator as delivered.
- Set the parameter "Manual control in case of bus voltage failure" to "disabled".  
Manual control is completely disabled when the bus voltage is off. In this case, bus operation is not possible either so that the outputs of the actuator can no longer be activated.
- Set the parameter "Manual control during bus operation" to "enabled".  
Manual control is then basically enabled when the bus voltage is on. The outputs of the actuator can be activated via the bus or manually. This setting corresponds to the setting of the actuator as delivered.
- Set the parameter "Manual control during bus operation" to "disabled".  
Manual control is completely disabled when the bus voltage is on. In this configuration, the actuator outputs can only be operated via the bus.

#### Presetting a manual control disable

The manual control mode can be separately disabled via the bus, even if it is already active. If the disabling function is enabled, then as soon as a disabling telegram is received via the disabling object of the manual control, the actuator immediately terminates an activated manual control and locks the function keys on the front panel of the device. The telegram polarity of the disabling object is parameterisable.



The manual control mode during bus operation must be enabled.

- Set the parameter "Disabling function ?" on parameter page "Manual control" to "yes".  
The disabling function of the manual control mode is enabled and the disabling object is visible.
- Select the desired telegram polarity in the "Disabling object polarity" parameter.
- i** If the polarity is "0 = disabled; 1 = enabled", the disabling function is immediately active on return of bus/mains voltage or after an ETS programming operation (object value "0"). To activate the manual control in this case, an enable telegram "1" must first be sent to the disabling object.
- i** In case of bus voltage failure, disabling via the disabling object is always inactive (depending on parameterization, the manual control is then either enabled or completely disabled). After bus and mains voltage return, a disabled state that was active beforehand is always inactive when the polarity of the disabling object is non-inverted. If only the bus voltage has failed and been switched on again (mains voltage is available without interruption), then an activated disable remains intact.
- i** When an active manual control is terminated by a disable, the actuator will also transmit a "Manual control inactive" status telegram to the bus, if the status messaging function is enabled.

### Presetting the status message function for the manual control mode

An actuator can transmit a status telegram to the bus via a separate object when the manual operation is activated or deactivated. The status telegram can only be transmitted when the bus voltage is switched on. The polarity of the status telegram can be parameterised.

The manual control mode during bus operation must be enabled.

- Set the parameter "Transmit status ?" on parameter page "Manual control" to "yes".  
The status messaging function of manual control is enabled and the status object is visible.
- Specify in the parameter "Status object function and polarity" whether the status telegram is generally a "1" telegram whenever the manual control mode is activated or only in those cases where the permanent manual mode is activated.
- i** The status object is always "0" when the manual control mode is deactivated.
- i** The status is not transmitted automatically after bus/mains voltage return.
- i** When active manual control is terminated by a disable, the actuator will also transmit a "Manual control inactive" status telegram to the bus.

### Presetting the behaviour at the beginning and at the end of manual control

The manual control distinguishes the temporary and permanent manual control. The behaviour is different depending on these modes of operation, especially at the end of manual control. It should always be noted that bus operation is always disabled while manual operation is active, as manual operation has a higher priority (see page 54-55).

Behaviour at the beginning of manual control:

The behaviour at the beginning of manual operation differs for temporary and permanent manual operation. On activation of short-time manual operation, the most recently set states of the outputs initially remain active. For opened valve outputs, the pulse width modulation is not adjusted to the preset value of manual operation. This only takes place when the valves are first closed and then reopened, in the course of brief manual operation. Even after permanent manual operation is switched on, the states of the outputs last set initially remain active. However, for opened valve outputs, the pulse width modulation is automatically adjusted to the preset value of manual operation.

Behaviour at the end of manual control:

The behaviour at the end of manual control is different for temporary and permanent manual

control.

The temporary manual mode is shut off automatically when the last output has been addressed and when the select key  is pressed once more. The state of all outputs set via manual control is not changed when temporary manual control is switched off. If, however, a function with a priority higher than that of normal operation (e.g. forced position, safety operation) was activated for the valve outputs via the bus before or during manual operation, the actuator executes the function with the higher priority for the outputs concerned.



The permanent manual control mode is shut off, when the select key  is pressed for more than 5 seconds. Depending on the configuration of the actuator in the ETS, the outputs will be set to the state last adjusted in the manual operation or to the state internally tracked (e.g. forced position, service operation) when permanent manual operation is switched off. The parameter "Behaviour at the end of permanent manual control during bus operation" defines the corresponding reaction.

- Set the parameter "Behaviour at the end of permanent manual control during bus operation" to "no change".

After the end of the permanent manual operation, the current state of all valve outputs remains unchanged. If, however, a function with a priority lower than that of manual operation (e.g. forced position, service mode) has been activated via the bus before or during manual operation, the actuator sets the reaction preset for this function for the appropriate outputs.

- Set the parameter "Behaviour at the end of permanent manual control during bus operation" to "track outputs".

During active permanent manual operation, all incoming telegrams and state changes are tracked internally. At the end of the manual operation, the valve outputs are set according to the most recently received command or the most recently activated function with a lower priority.

-  The behaviour at the end of the permanent manual control when the bus voltage is off (e.g. building site operation) is permanently set to "no change".
-  The control operations triggered in the manual control mode will be transmitted via feedback objects to the bus, if enabled and actively transmitting.
-  During an ETS programming operation, an activated manual operation mode will always be terminated. In this case, the parameterized or predefined behaviour at the end of manual control will not be executed. The actuator executes the configured behaviour after ETS programming instead.

## Setting the behaviour of manual operation to bus voltage return

An active short-time or permanent manual operation can be terminated as option, should the bus voltage fail, or not. The following always applies: If the mains voltage supply is not switched on, manual operation is possible if bus voltage is available (valve output can only be activated if a valve power supply is available). If, in this case, the bus voltage is switched off, the actuator also always exits manual operation, as there is no power supply to the device electronics. After the bus voltage return (mains power supply switched on), manual operation is always deactivated.

- Set the "Behaviour of manual operation on bus voltage return" parameter to "Exit manual operation".

After the bus voltage return through a mains power supply being available, active manual operation is exited. For example, this means that it is possible to deactivate manual operation through a simultaneous bus reset on multiple actuators with the same parameter setting.

- Set the "Behaviour of manual operation on bus voltage return" parameter to "Do not exit manual operation".

After the bus voltage return through a mains power supply being available, active manual operation is never exited.

## Setting disabling of the bus control

Individual valve outputs can be disabled locally during permanent manual operation, so that the disabled outputs can no longer be activated using input command value telegrams or lower-priority device functions. Such disabling of the bus operation is initiated by local operation in permanent manual operation and is indicated by rapid flashing of the status LEDs on the front panel of the device. The disabled outputs can then only be activated in permanent manual control.

The manual control mode during bus operation must be enabled.

- Set the "Disable bus control of individual outputs during bus operation" parameter on parameter page "Manual control" to "yes".

The function for disabling the bus control is enabled and can be activated locally.

- Set the "Disable bus control of individual outputs during bus operation" parameter on parameter page "Manual operation" to "No".

The function for disabling the bus control is deactivated.

- i** A locally instigated disable overrides all the other functions of the actuator that can be activated via the bus (e.g. service mode or forced position). Depending on the configuration of the actuator in the ETS, the outputs will be set to the state most recently set or internally tracked after the disabling and subsequent deactivation of permanent manual operation.
- i** Any disabling of the bus control activated locally is not reset after bus voltage return if the mains voltage was switched on interruption free. A failure of the bus and mains voltage or ETS programming operation always deactivates the disabling of the bus control.

## Setting the cycle time and PWM of manual operation

During manual operation, all the valve outputs are activated with a pulse width modulation (PWM) using the **OPEN** button, irrespective of the configured command value data format (1-bit or 1-byte). Taking the cycle time set in the device into account, the average output signal resulting from the statically configured pulse width modulation is a measure of the centred valve position of the control valve and thus a reference for the set room temperature for manual operation. The cycle time of the PWM signal can, like PWM itself, be configured centrally on the parameter page "Manual operation" in the ETS. In consequence, a manual operation locally on the device can allow the use of a different cycle time than in normal operation of the actuator (activation via KNX telegrams).

The **CLOSE** command always closes the valves completely (0 %). In the central operating function of all valve outputs with the **ALL OP / CL** button, the actuator always activates the valve outputs with a constant signal (0 % or 100 %).

- Configure the parameters "Cycle time for manual operation" and "PWM for manual operation (5...100 %)" on the "Manual operation" parameter page to the required values.

For opened valve outputs, the actuator sets the set pulse width modulation (PWM) with the preset cycle time. With short-time manual operation, this only takes place when the **OPEN** button has been pressed. In permanent manual operation, the actuator sets the PWM immediately after the activation of manual operation for opened valve outputs.

In manual operation, the configured valve direction of action (deenergised closed / deenergised opened) is taken into account during valve activation. With deenergised closed valves, the switch-on time is derived directly from the configured PWM and the cycle time.

Example: PWM = 30 %, cycle time = 10 minutes -> Switch-on time = 3 minutes, switch-off time = 7 minutes.

In the case of deenergised opened valves, the switch-on time is inverted. Example: PWM = 30 %, cycle time = 10 minutes -> Switch-on time = 7 minutes, switch-off time = 3 minutes.

- i** In the as-delivered state, the actuator works with a PWM of 50 % and a cycle time of 20 minutes.

## 4.2.4.1.4 Service mode

Service mode allows the bus-controlled locking of all or some valve outputs for maintenance or installation purposes. If service mode is active, actuators can be moved to a defined position (completely open or closed) and locked against activation by command value telegrams. Both service mode and the locking state are preset by a 2-bit forced operation telegram, according to KNX DPT 2.001.

The first bit (bit 0) of the object "Service mode - Activate / deactivate input" directly specifies the locking state. The second bit (bit 1) of the object activates or deactivates service mode. The locking state in the telegram is only evaluated by the actuator, when bit 1 plans for active service mode. Otherwise, bit 0 is ignored.

- i The valves activated by service mode open or close completely and statically. No pulse width modulation is executed. The configured valve direction of action is taken into account in the electrical activation of the outputs.

Bit 1	Bit 0	Function
0	x	Service mode not active -> normal control according to priority rule
0	x	Service mode not active -> normal control according to priority rule
1	0	Service mode active: Close valves
1	1	Service mode active: Open valves

### Bit coding of service mode

Service mode influences the status signals of the affected valve outputs. Depending on the configured command value data format, the following command values are assumed when service mode is active...

- Switching (1 bit):  
Valve closed = OFF  
Valve opened = ON
- Constant (1-byte) with pulse width modulation (PWM):  
Valve closed = 0 %  
Valve opened = 100 %
- Constant (1-byte) with command value limiting value:  
Valve closed = OFF  
Valve opened = ON

- i The command value preset by an active service mode is also included in the determination of heat requirements and the largest command value. In addition, service mode has an influence on pump control.

The behaviour of the assigned valve outputs at the end of service mode can be configured. In addition, a 1-bit status object can signal when service mode is active or not.

- i Updates of the object from "Service mode active" to "Service mode active" while maintaining the forced valve status or from "Service mode inactive" to "Service mode inactive" produce no change in the behaviour of the value outputs. However, the status telegram of the service mode is retransmitted on each update.
- i Valve outputs locked by service mode can still be activated in manual operation. At the end of a manual operation, the actuator executes the service reaction for the appropriate valve outputs once again if service mode is still activated at this time.

### Enabling service mode

Service mode must first be enabled on the "General" parameter page, so that it can be activated and deactivated via the KNX during actuator operation.

- Set the parameter "Use service mode ?" to "yes".

Service mode is enabled. The communication object "Service mode - Deactivate / activate input" becomes visible. Valve outputs can be assigned on the parameter pages "Ax - assignments".

- Set the parameter "Use service mode ?" to "no".

Service mode is not available. No valve outputs can be assigned to service mode in the ETS.

## Assign outputs to service mode

For a valve output to be influenced by service mode, an assignment must take place. On the parameter pages "Ax - Assignments", it is possible to define the assignment to service mode separately for each valve output.

- Set the parameter "Assignment to service mode ?" to "yes".

The appropriate valve output is assigned to service mode. It is locked according to the object value when service mode is active.

- Set the parameter "Assignment to service mode ?" to "no".

The valve output is not assigned to service mode. Activation and deactivation of the service function does not influence the output.

**i** Assignments can only be made on the parameter pages "Ax - Assignments" if service mode is enabled on the "General" parameter page.

## Defining the behaviour at the end of service mode

When service mode is deactivated, the assigned valve outputs are enabled again. Activation of these outputs using command value telegrams or other functions with a lower priority is then possible. The parameter "Behaviour at the end of service mode" specifies the state to which the affected valve outputs go after enabling.

**i** At the end of service mode, the actuator only then executes the configured behaviour if, at the time of enabling, no function with a lower priority is active. Should such a function be active (e.g. forced position), then the actuator will execute it.

- Set the parameter to "No change".

In this setting, assigned valve outputs show no reaction at the end of service mode. They remain in the most recently set state, until a new command value presetting is implemented.

- Set the parameter to "Close all outputs completely".

In this setting, all the assigned valve outputs close completely. Here too, the actuators remain in this state until a new command value presetting is implemented.

- Set the parameter to "Open all outputs completely".

In this setting, all the assigned valve outputs open completely. The actuators remain in this state until a new command value presetting is implemented.

- Set the parameter to "Track states".

In this configuration, the valve state received during the service function or preset by the function is tracked at the end of service mode.

## Configuring the status function of service mode

An active service mode can optionally be displayed by a 1-bit status object. A telegram with the value "1" displays an active service mode. A telegram with the value "0" displays a deactivated service function.

As soon as service mode is enabled in the ETS, the status communication object is also available.

- i** Updates of the 2-bit input object from "Service mode active" to "Service mode active" or from "Service mode inactive" to "Service mode inactive" always causes retransmission of the status telegram.
- i** The object value of the status function is not transmitted automatically to the bus after a device reset (ETS programming operation, bus/mains voltage return).

## 4.2.4.1.5 Collective feedback

After central commands or after bus/mains voltage return, a KNX line is generally heavily loaded by data traffic as many bus devices are transmitting the state of their communication objects by means of feedback telegrams. This effect occurs particularly when using visualisations. Collective feedback can be used to keep the telegram load low during initialisation. The collective feedback summarises the states of all valve outputs in bit-orientated form (Figure 5).

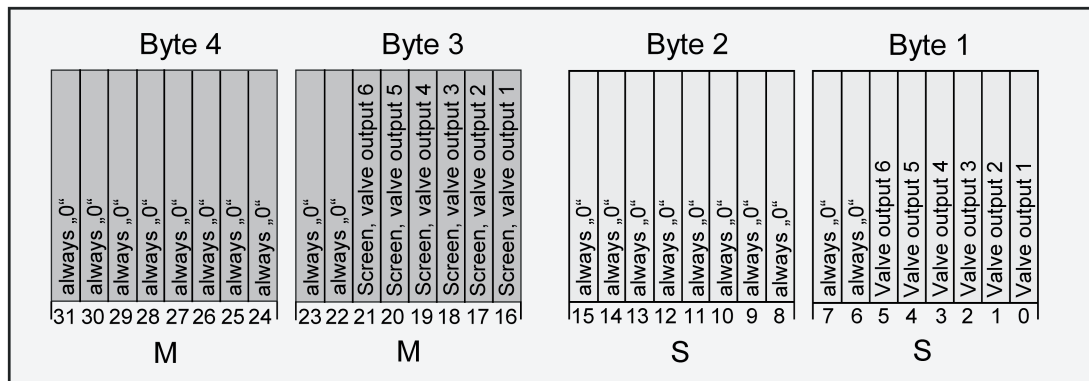

Figure 5: Object structure of the collective feedback

The 4-byte object of the collective feedback contains the status information of all 6 valve outputs. Each valve output has one bit representing the state ("S" bit) and another one defining the masking ("M" bit). The "S" bits correspond to the logical valve states and are either "1" (Valve opened) or "0" (Valve closed). Through the state "1", the "M" bits show that the output exists and, therefore, the corresponding "S" bit can be evaluated. The "0" state in an "M" bit shows that the actuator does not possess this output number. In this case, the corresponding "S" bits are constantly "0", as there is no valve state.

The following heating actuator possesses 6 outputs. As a result, the following example object values result...

- "00 3F 00 xx", x = switching states
- > Only valve outputs 1 and 2 opened: "00 3F 00 03"
- > Only valve outputs 1 and 3 opened: "00 3F 00 05"
- > All valve outputs opened: "00 3F 00 3F"

The status of the "S" bits in the collective feedback is dependent on the active command value of a valve output. Constant command values are converted into a 1-bit status:

0 % -> "0" / "1...100 %" -> "1"

The valve direction of action configured for each output in the ETS is also evaluated in the electrical activation of the actuators.



Command value	Parameter "Data format of the command value input"	Parameter "Valve in voltage-free state"	Limiting value of the command value for opening the valve	Valve output	Collective feedback "S" bits
„0“	switching (1 bit)	closed	...	OFF	0
		open	...	ON	0
„1“	switching (1 bit)	closed	...	ON	1
		open	...	OFF	1
„0 %“	constant (1 byte) with PWM	closed	...	OFF	0
		open	...	PWM active	0
	constant (1 byte) with limiting value	closed	...	OFF	0
		open	...	ON	0
„1...100 %“	constant (1 byte) with PWM	closed	...	PWM active	1
		open	...	OFF	1
	constant (1 byte) with limiting value	closed	Command value < Limiting value hysteresis	OFF	0
		open	Command value < Limiting value hysteresis	ON	0
		closed	Command value >= Limiting value	ON	1
		open	Command value >= Limiting value	OFF	1

Figure 6: Status in the collective feedback, dependent on the command value and configuration of the valve outputs

Use of the collective feedback would be possible in appropriate visualisation applications - for example, in public buildings such as schools or hospitals - where the valve states of the actuators are displayed centrally and there is no separate state display at the control sections. In such applications, the collective feedback can replace the status individual feedback and thereby reduce the bus load.

### Activate collective feedback

Collective feedback is a global device function and can be enabled in the parameter node "Valve / Pump".

- Set the parameter "Collect. feedbk status of value outputs (opened / closed) ?" to "yes".  
Collective feedback is enabled. The collective feedback object becomes visible in the ETS.
- Set the parameter to "no".

Collective feedback is deactivated. No collective feedback object is available.

### Collective feedback type

Collective feedback can be provided in the function of an active signalling object or a passive status object. In the case of an active signal object, the feedback is automatically transmitted to the bus whenever the status contained therein changes. In the function as a passive status object, there is no automatic telegram transmission. In this case, the object value must be read out. The ETS automatically sets the object communication flags required for proper functioning.

Collective feedback must be enabled.

- Set the parameter "Type of collective feedback" to "Active signalling object".  
The actuator transmits the collective feedback automatically when the object value is updated. After a device reset (ETS programming operation, bus and mains voltage return, only bus voltage return), current collective feedback is always transmitted.
- Set the parameter to "Passive status object".  
Collective feedback will only be transmitted in response if the object is read out from the bus. No automatic telegram transmission of the collective feedback takes place after bus or mains voltage return or after an ETS programming operation.

### Setting collective feedback after bus/mains voltage return or after programming with the ETS

If used as active signal object, the collective feedback is transmitted to the bus after bus and mains voltage return, after just bus voltage return or after an ETS programming operation. In these cases, the feedback can be time-delayed with the time delay being preset globally for all device feedback together on the "General" parameter page.

Collective feedback must be enabled and the feedback type set to "Active message object".

- Set the parameter "Time delay for feedback after bus voltage return ?" to "yes".  
The collective feedback telegram is transmitted with a delay after bus and mains voltage return, after just bus voltage return or after programming in ETS. No feedback is transmitted during a running time delay, even if a valve state changes.
- Set the parameter "Time delay for feedback after bus voltage return ?" to "no".  
The collective feedback is transmitted immediately after bus / mains voltage return or after an ETS programming operation.

### Setting cyclic transmission of the collective feedback

The object of the collective feedback can also transmit its value cyclically in addition to transmission when updating.

Collective feedback must be enabled and the feedback type set to "Active message object".

- Set the parameter "Cyclical transmission of feedback telegram?" to "yes".  
Cyclical transmission is activated.
- Set the parameter "Cyclical transmission of the collective feedback ?" to "no".  
Cyclical transmission is deactivated, which means that collective feedback is only transmitted to the bus if one of the valve states changes.

 The cycle time for all cyclic feedback telegrams is defined centrally on the parameter page "General".

- i** During an active delay, no collective feedback telegram will be transmitted even if a valve state changes.

## 4.2.4.1.6 Summer / winter switch-over

The actuator possesses a summer / winter switch-over. Depending on the season, this allows the setting of different command value setpoints for a valve output for emergency operation or forced position. Summer or winter mode is directly preset by the 1-bit communication object "Summer / winter switch-over". The telegram polarity can be configured in the ETS.

The "Summer" or "Winter" state preset via the object is stored internally in the device and is restored after a device reset. In the ETS, it is possible to configure whether, after an ETS programming operation, the saved value is restored or, alternatively, if a defined operation (summer or winter) is activated.

It is also possible to switch the operating mode during active emergency operation (if called by command value monitoring) or during an active forced position (if activated via the object). In this case, the value belonging to the operating mode is activated immediately after the switch-over. If the value for emergency operation or the forced position is polled on a bus/mains voltage return or after an ETS programming operation, the command values do not change when the operating mode is switched over.

### Enable summer / winter switch-over

The summer / winter switch-over must first be enabled on the "General" parameter page, so that it is possible to switch between summer and winter mode during actuator operation.

- Set the "Summer/winter mode switch-over ?" parameter to "yes". Configure the parameter "Polarity of 'Summer / winter switch-over' object" to the required telegram polarity.

The summer / winter switch-over is enabled. The communication object "Summer / winter switch-over" becomes visible in the ETS. Summer and winter command values can be configured for emergency operation and a forced position for the valve outputs.

- Set the "Summer/winter mode switch-over ?" parameter to "no".

The summer / winter switch-over is not available. For the valve outputs, only one command value can be configured separately for emergency operation or a forced position.

### Define the behaviour after of the summer / winter switch-over during an ETS programming operation

The "Summer" or "Winter" state preset via the object "Summer / winter switch-over" is stored internally in the device and is restored after a device reset (bus or mains voltage return). The parameter "Operating mode after ETS programming operation" on the parameter page "General" also defines which operating mode is active after ETS commissioning.

- Set the parameter to "Summer mode".

In this setting, the actuator activates summer operation after an ETS programming operation. This overwrites the value saved internally in the device.

- Set the parameter to "winter mode".

In this setting, the actuator activates winter mode after an ETS programming operation. This overwrites the value saved internally in the device.

- Set the parameter to "No change (saved operating mode)".

In this configuration, the actuator activates the most recently saved operating mode.

- i** The operating mode tracked after bus/mains return or preset after an ETS programming operation is not tracked in the communication object by the actuator.

## 4.2.4.1.7 Heat requirement and largest command value

### Heat requirement control

The heating actuator possesses heat requirement control. Here, the actuator continuously evaluates the command values of assigned outputs and makes general heat requirement information available as a 1-bit control value in the form of limiting value monitoring with hysteresis. Using a KNX switch actuator, this allows the energy-efficient activation of burner and boiler controllers with suitable control inputs (e.g. requirement-orientated switch-over between the reduction and comfort setpoint in a central combi boiler).

A heat requirement is only signalled by the actuator via the object of the same name when at least one command variable of the assigned outputs exceeds a limiting value with hysteresis defined in the ETS. A heat requirement signal is retracted when the limiting value is reached or undershot again (Figure 7). The telegram polarity of the heat requirement information can be configured.

- i** In addition, valve outputs, which receive preset command values via the data format "Switching (1-bit)" and "Switching (1-byte) with command value limiting value", influence the heat requirement control. In the case of "Switching (1-bit)", an "OFF" command value is interpreted as "0 %" and an "ON" command value as "100 %". In the case of "Switching (1-byte) with command value limiting value", the actuator evaluates the converted switching output signal in the same way ("OFF" is interpreted as "0 %", "ON" is interpreted as "100 %").
- i** With some functions and events, valve outputs, which are configured to the command value data formats "Switching (1-bit)" and "Switching (1-byte) with command value limiting value", are always activated via a constant command value through pulse width modulation (PWM), providing that command values not equal to 0 % or 100 % are to be set (after bus voltage return, after an ETS programming operation, during manual operation, with an active forced position and with active emergency operation). PWM keeps being executed until the named functions have been exited or, after the named events, no more lower-level functions are active and a new command value telegram is received via the bus, overriding the constant command value on the valve output.  
In this case, the constant command value set by the PWM is also included in the heat requirement control.
- i** After bus voltage return and an ETS programming operation, the actuator always first transmits the status "No heat requirement" without a delay. The actuator then updates the status to "Heat requirement", providing that the condition for this has been fulfilled and an optionally configured "Heat requirement ACTIVE" has elapsed.
- i** A valve output affected by a short-circuit / overload (valve completely closed on deenergised closed or completely opened on deenergised opened) does not influence the heat requirement control.

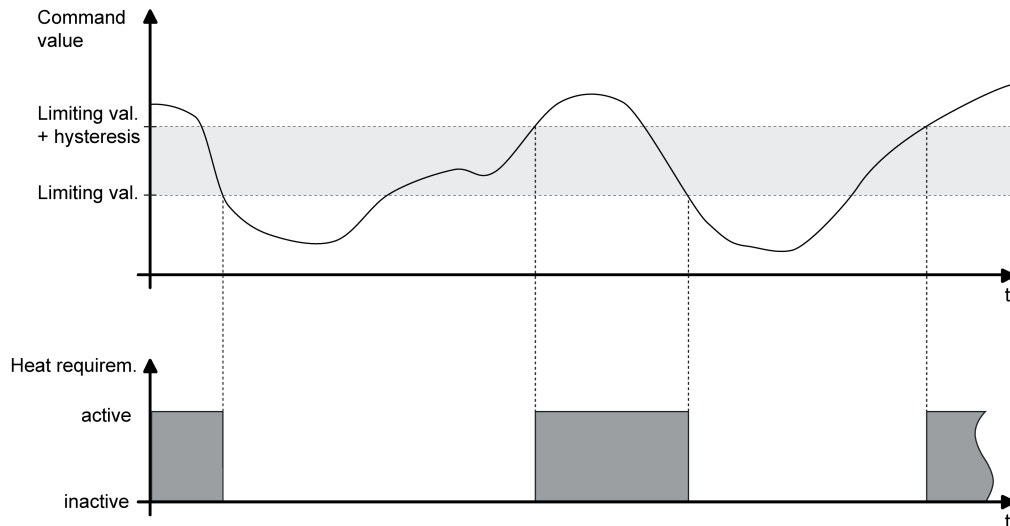

Figure 7: Heat requirement information with sample command value characteristic

Optionally, the actuator can evaluate an external telegram for heat requirement information (e.g. from another heating actuator). This allows the cascading of multiple actuators with a heat requirement signal. The local heating actuator links the 1-bit telegram value of "External heat requirement" object with the internal state of its own heat requirement logically as OR and outputs the result of this link via the object "Heat requirement". The telegram polarity of the external object is fixed: "0" = Heat requirement INACTIVE, "1" = Heat requirement ACTIVE.

The actuator only outputs the telegram of an active heat requirement after determination when the delay time defined by the parameter "Delay heat requirement INACTIVE" has elapsed. No heat requirement request is transmitted if the actuator no longer determines a heat requirement within the preset time.

The actuator only retracts heat requirement information after determination when the delay time defined by the parameter "Delay heat requirement INACTIVE" has elapsed. The heat requirement information is not retracted if the actuator no longer determines a new heat requirement within the preset time.

### Enabling and configuring the Heat requirement function

The Heat requirement function must first be enabled on the "Valves / Pump" parameter page, so that it can be used during actuator operation.

- Set the parameter "Activate function 'Heat requirement' ?" to "yes". Configure the parameter "Polarity of 'Summer Heat requirement' object" to the required telegram polarity. In addition, define the limiting value and hysteresis.

Heat requirement control is activated. The heat requirement information becomes active according to the set telegram polarity, if at least one command value of the assigned valve outputs exceeds the configured limiting value plus hysteresis. The heat requirement becomes inactive when the limiting value is reached or undershot again.

The valve outputs must be assigned to the heat requirement control individually on the parameter pages "Ax - Assignments", so that they are included in the requirement determination.

- Set the parameter "Activate function 'Heat requirement' ?" to "no". Heat requirement control is not available.

## Enabling detection of an external heat requirement

Optionally, the actuator can evaluate an external telegram for heat requirement information (e.g. from another heating actuator). This allows the cascading of multiple actuators with a heat requirement signal.

The object must be enabled for an external heat requirement to be recorded.

- Set the parameter "Record external heat requirement ?" to "yes".  
The "External heat requirement" object is enabled. The local heating actuator links the 1-bit telegram value of this object with the internal state of its own heat requirement logically as OR and outputs the result of this link via the object "Heat requirement".
- Set the parameter "Record external heat requirement ?" to "no".  
Detection of an external heat requirement is not possible. The actuator only determines the heat requirement information itself.
- ❗ Cyclical telegrams to the object "External heat requirement" with an identical telegram polarity (ON -> ON, OFF -> OFF) cause no reaction.
- ❗ After a device reset, there is no polling of the current status of the object "External heat requirement". Only when a bus telegram is received does the actuator take this status into account during evaluation of the heat requirement.

## Configure delay for heat requirement control

If necessary, the activation and deactivation of the heat requirement information can be delayed.

- Set the parameter "Delay heat requirement ACTIVE" to the desired time.  
The actuator only outputs the telegram of an active heat requirement after determination when the defined delay time has elapsed. No heat requirement request is transmitted if the actuator no longer determines a heat requirement within the preset time.
- Set the parameter "Delay heat requirement INACTIVE" to the desired time.  
The actuator only retracts heat requirement information after determination when the defined delay time has elapsed. The heat requirement information is not retracted if the actuator no longer determines a new heat requirement within the preset time.

## Largest command value

Through evaluation and determination of the largest command value in the heating or cooling system, the actuator allows influencing of the energy consumption of a housing or commercial building. The information on the largest active 1-byte command value can be made available to suitable calorific furnaces with integrated KNX controller directly via a KNX telegram, for example, to determine the optimum flow temperature. If the function is enabled, the heating actuator evaluates all the active 1-byte command values of the valve outputs and transmits the externally received largest command value if there is a change by the interval preset in the ETS or cyclically via the object "Largest command value".

- ❗ In the case of valve outputs configured in the ETS to the command value data formats "Switching (1-bit)" or "Constant (1-byte) with command value limiting value", there is no evaluation of the command values preset via the bus.  
Exception: It may also occur with such command value outputs that a constant command value is active (after bus voltage return, after an ETS programming operation, during manual operation, with an active forced position and with active emergency operation). In this case, this constant command value is also included in the calculation of the largest command value until the named functions with a higher priority are exited or a new command value telegram is received via the bus, overriding the constant command value at the valve output.

- i** After bus voltage return and an ETS programming operation, the actuator transmits the current value of the largest command value without a delay, providing that automatic transmission on change is configured. After a full device reset, the actuator does not transmit automatically, when all the command values are set to 0 %.  
After a device reset, the actuator immediately starts the time for cyclical transmission (if configured), so that the object value effective after the reset is transmitted cyclically.
- i** A valve output affected by a short-circuit / overload (valve completely closed on deenergised closed or completely opened on deenergised opened) does not influence the evaluation of the largest command value.

Optionally, the actuator can evaluate an external telegram for the largest command value (e.g. from another heating actuator). This allows the cascading of multiple actuators with a command value signal. The local heating actuator compares the 1-byte telegram value of the object "External largest command value" with its own largest command value and outputs the largest value via the object "Largest command value".

### **Enabling the "Largest command value" function**

The "Largest command value" function must first be enabled on the "Valves / Pump" parameter page, so that it can be used during actuator operation.

- Set the parameter "Activate 'Largest command value' function ?" to "yes".  
The "Largest command value" function is activated. The actuator always compares the 1-byte command values of assigned valve outputs and signals the largest command value via the communication object of the same name.
- Set the parameter "Activate 'Largest command value' function ?" to "no".  
The function for transferring the largest command value is not available.

### **Configuring the transmission behaviour of the "Largest command value" function**

The largest command value determined by the heating actuator is actively transmitted to the bus. The "Transmit largest command value" parameter decides when a telegram is transmitted via the "Largest command value" object.

- Set the parameter to "Only on change". Configure the parameter "Transmit on change by" to the required change interval for automatic transmission.  
A telegram is only transmitted when the largest command value changes by the configured change interval.
- Set the parameter to "Only cyclical".  
The actuator only transmits the "Largest command value" telegram cyclically. The cycle time is defined globally for all feedback on the parameter page "General".
- Set the parameter to "On change and cyclically". Configure the parameter "Transmit on change by" to the required change interval for automatic transmission.  
The actuator transmits the "Largest command value" telegram cyclically and also when the largest command value changes by the configured change interval.

### **Enabling recording of an external largest command value**

Optionally, the actuator can evaluate an external telegram for the largest command value (e.g. from another heating actuator). This allows the cascading of multiple actuators with a command value signal.

The object must be enabled for an external largest command value to be recorded.



- Set the "Record external largest command value ?" to "yes".  
The "External largest command value" object is enabled. The local heating actuator compares the 1-byte telegram value of this object with its own largest command value and outputs the largest value via the object "Largest command value".
- Set the "Record external largest command value ?" to "no".  
Recording of an external largest command value is not possible. The actuator independently determines the largest command value of the valve outputs assigned to it.
- ❗ Cyclical telegrams to the "External largest command value" object with the same telegram value cause no reaction.
- ❗ After a device reset, there is no polling of the current status of the "External largest command value" object. Only when a bus telegram is received does the actuator take this value into account during evaluation of the largest command value.

## 4.2.4.1.8 Pump control

The heating actuator allows switching activation of the circulation pump of the heating or cooling circuit via a 1-bit KNX telegram. When using the pump controller, the pump is only switched on by the actuator via the "Switch pump" object, when at least one command variable of the assigned outputs exceeded a limiting value with hysteresis defined in the ETS. The pump is switched off when the limiting value is reached or undershot again (Figure 8). This saves electrical energy, as the pump is only activated by sufficiently large, and thus effective, command values.

Optional cyclical anti-sticking protection prevents the sticking of the pump, if it has not been switched on by the command value evaluation for a longer period of time. The telegram polarity of the pump control can be configured.

- i** In addition, valve outputs, which receive preset command values via the data format "Switching (1-bit)" and "Switching (1-byte) with command value limiting value", influence the pump control. In the case of "Switching (1-bit)", an "OFF" command value is interpreted as "0 %" and an "ON" command value as "100 %". In the case of "Switching (1-byte) with command value limiting value", the actuator evaluates the converted switching output signal in the same way ("OFF" is interpreted as "0 %", "ON" is interpreted as "100 %").
- i** With some functions and events, valve outputs, which are configured to the command value data formats "Switching (1-bit)" and "Switching (1-byte) with command value limiting value", are always activated via a constant command value through pulse width modulation (PWM), providing that command values not equal to 0 % or 100 % are to be set (after bus voltage return, after an ETS programming operation, during manual operation, with an active forced position and with active emergency operation). PWM keeps being executed until the named functions have been exited or, after the named events, no more lower-level functions are active and a new command value telegram is received via the bus, overriding the constant command value on the valve output.  
In this case, the constant command value set by the PWM is also included in the pump control.
- i** After bus voltage return and an ETS programming operation, the actuator always first transmits the status "Pump OFF" without a delay. The actuator then updates the status to "Pump ON", providing that the condition for this has been fulfilled and an optionally configured "Pump delay ACTIVE" has elapsed.
- i** A valve output affected by a short-circuit / overload (valve completely closed on deenergised closed or completely opened on deenergised opened) does not influence the pump control.

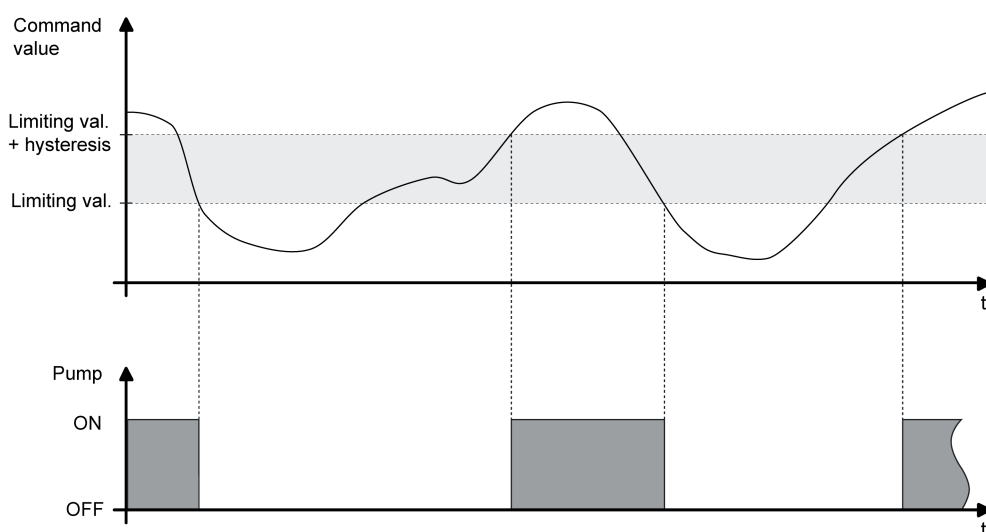

Figure 8: Pump control with sample command value characteristic

Optionally, the actuator can evaluate an external pump control signal (e.g. from another heating actuator). This allows the cascading of multiple actuators with pump control. The local heating

actuator links the 1-bit telegram value of the "External pump control" object with the internal state of the pump logically as OR and outputs the result of this link via the "Switch pump" object. The telegram polarity of the external object is fixed: "0" = Pump OFF, "1" = Pump ON.

The actuator only outputs the ON telegram to the pump after determination when the defined delay time has elapsed. The pump is not switched on when the actuator determines within the preset time that the pump must remain switched off, due to a limiting value plus hysteresis again being undershot.

The actuator only outputs the OFF telegram to the pump after determination when the defined delay time has elapsed. The pump is not switched on when the actuator determines within the preset time that the pump must remain switched off, due to a limiting value again being exceeded.

The delay times of the pump controller can be used as an example to match the running time of the pump to the reaction time of the actuated actuators. Thus, a pump should only switch on when the actuators actually open after electrical activation by the actuator (match pump ACTIVE delay with the dead time of the actuators). The same applies to the closing of the valve drives.

If pump control is enabled, optional cyclical anti-sticking protection can prevent the sticking of the pump, if it has not been switched on by the command value evaluation for a longer period of time (e.g. in the case of heating systems in the summer months). When anti-sticking protection is enabled, the parameter "Time for cyclical switching on of the pump" defines the weekly interval of the protection function. If the pump is not switched on at least once during the set time by the pump controller, then the actuator will execute anti-sticking protection, if necessary on a regular basis. The cycle time is reset and restarted on each actuation of the pump by the pump control. The cycle time is started for the first time after a device reset.

When anti-sticking protection is enabled, the parameter "Pump switch-on time" defines the length of pump running for the cyclical protection function. The actuator then switches the pump on for the set time without interruption, assuming that anti-sticking protection must be executed.

## Enabling and configuring the pump control function

The pump control must first be enabled on the "Valves / Pump" parameter page, so that it can be used during actuator operation.

- Set the "Activate 'Pump control' function ?" parameter to "yes". Configure the parameter "Polarity of 'Pump control' object" to the required telegram polarity. In addition, define the limiting value and hysteresis.

Pump control is activated. The pump is switched on according to the set telegram polarity, if at least one command value of the assigned valve outputs exceeds the configured limiting value plus hysteresis. The pump is switched off when the limiting value is reached or undershot again.

The valve outputs must be assigned to the pump control individually on the parameter pages "Ax - Assignments", so that they are included in the command value evaluation.

- Set the "Activate 'Pump control' function ?" parameter to "no".

Pump control is not available.

## Enabling detection of an external pump control

Optionally, the actuator can evaluate an external telegram for pump control (e.g. from another heating actuator). This allows the cascading of multiple actuators with pump control.

The object must be enabled for an external pump control signal to be detected.

- Set the parameter "Detect external pump control ?" to "yes".

The "External pump control" object is enabled. The local heating actuator links the 1-bit telegram value of this object with the internal state of its own pump control logically as OR and outputs the result of this link via the "Switch pump" object.

- Set the parameter "Detect external pump control ?" to "no".  
Recording of an external pump control signal is not possible. The actuator only controls the pump itself.
- ❗ Cyclical telegrams to the "External pump control" object with an identical telegram polarity (ON -> ON, OFF -> OFF) cause no reaction.
- ❗ After a device reset, there is no polling of the current status of the "External pump control" object. Only when a bus telegram is received does the actuator take this status into account when controlling the pump.

### Configuring the anti-sticking protection of the pump controller

If pump control is enabled, optional cyclical anti-sticking protection can prevent the sticking of the pump, if it has not been switched on by the command value evaluation for a longer period of time. The anti-sticking protection must first be enabled on the "Valves / Pump" parameter page, so that it can be executed during actuator operation.

- Set the "Activate anti-sticking protection ?" parameter to "yes". In addition, define the interval of the protection function in the parameter "Time for cyclical switching on of the pump". Configure the parameter "Pump switch-on time" to the required length of the pump run.  
Anti-sticking protection is activated. If the pump is not switched on at least once during the set time by the pump controller, then the actuator will executed anti-sticking protection, if necessary on a regular basis. The actuator then switches the pump on for the preset switch-on time.
- Set the "Activate anti-sticking protection ?" parameter to "no".  
Anti-sticking protection is deactivated.
- ❗ Once started, the anti-sticking protection always runs through to the end. It cannot be cancelled prematurely through the reception of new command values and the resulting restart of the cycle time.

## 4.2.4.1.9 Failure of the valve operating voltage

To activate the valve drives, the actuator requires a separate operating voltage supply (AC 24 V or AC 230 V). Valve outputs can only be electrically activated when the valve operating voltage supply is switched on. If there is no valve voltage supply, then the drives will move to their idle position (deenergised opened / closed). To prevent a failure of the valve voltage supply at the actuator from going undetected, a 1-bit fault signal can be optionally transmitted to the bus via the object "Failure of operating voltage". The telegram polarity of this fault signal can be configured.

If the actuator detects that there is no valve voltage, then the failure telegram ("Voltage failed") is transmitted immediately. Only when the valve voltage has been reconnected will the actuator retract the fault signal ("Voltage available").

A valve which has been completely opened (deenergised opened) by the failure of the valve operating voltage is not include in the determination of heat requirement or the "Largest command value" and has no influence on the pump control.

### Enabling the signal "Failure of the valve operating voltage"

The failure signal on the valve operating voltage must first be enabled on the "Valves / Pump" parameter page, so that it can be evaluated during actuator operation.

- Set the "Signal operating voltage failure of the valves?" parameter to "yes". Configure the parameter "Polarity of 'Failure of operating voltage' object" to the required telegram polarity.  
The failure signal is enabled. The actuator actively transmits a "Voltage failed" telegram when it detects a failed or switched-off valve voltage supply, when the bus voltage supply is still switched on. The actuator transmits a "Voltage available" telegram as soon as the valve voltage supply is available again and the bus voltage is switched on.
- Set the "Signal operating voltage failure of the valves?" parameter to "no".  
The failure signal is not available.

### Setting the behaviour of the failure signal on bus voltage return

The object for the transmission of a failure of the valve operating voltage can actively transmit the feedback information after a bus voltage return and an ETS programming operation. As an option, it is possible to configure in the ETS whether active telegram transmission should take place after a device reset or not.

After a device reset, the failure signal of the valve operating voltage supply can be optionally time-delayed with the delay being preset globally for all device feedback together on the "General" parameter page.

- Set the "Send feedback after bus voltage return ?" parameter to "yes".  
The feedback "Failure of operating voltage" is transmitted actively after bus and mains voltage return, after just bus voltage return or after programming in ETS.
- Only on "Send feedback after bus voltage return ?" = "Yes": Set the parameter "Time delay for feedback after bus voltage return ?" to "yes".  
The feedback "Failure of operating voltage" is transmitted with a delay after bus and mains voltage return, after just bus voltage return or after programming in ETS. No feedback is transmitted during a running time delay, even if the state changes.
- Only on "Send feedback after bus voltage return ?" = "Yes": Set the parameter "Time delay for feedback after bus voltage return ?" to "no".  
The feedback "Failure of operating voltage" is transmitted immediately after bus / mains voltage return or after an ETS programming operation.
- Set the "Send feedback after bus voltage return ?" parameter to "no".

The feedback is not transmitted automatically after a device reset.

### Setting cyclical transmission of the failure signal

The signal telegram "Failure of operating voltage" can be transmitted cyclically, should the actuator determine a failed valve operating voltage. If the valve operating voltage exists, then transmission is generally not cyclical.

- Set the "Cyclical transmission of the feedback if no voltage present ?" parameter to "yes".  
The actuator repeats the signal telegram "Failure of operating voltage", should a failed valve operating voltage have been determined. The cycle time is defined for all feedback on the "General" parameter page.
  - Set the "Cyclical transmission of the feedback if no voltage present ?" parameter to "no".  
The signal telegram "Failure of operating voltage" is generally not repeated cyclically.
- i** During a delay after bus/mains voltage return or an ETS programming operation, transmission is not cyclical.

### 4.2.4.1.10 Internal group communication

The actuator contains up to 6 room temperature controllers (RTC), which are integrated in the device software and which work independently of the process. The command value outputs of these controllers can be internally linked to the electronic valve outputs of the actuator, meaning that temperature control and valve activation can take place using just one bus device, if required. This function is implemented through special internal group communication.

Internal group communication interconnects device functions, without using external group addresses which are linked to communication objects. This means that it is possible to link any command value outputs of the internal controller with the valve outputs of the actuator via parameters in the application program. The precondition is that the data formats (1-bit / 1-byte) of the command value inputs and outputs to be linked are identical. The actual linking takes place via internal group addresses, which are linked to any possible command value.

If internal group communication is to be used, then this must be enabled centrally on the "General" parameter page. If the enabling is granted, the command value inputs of the up to 6 valve outputs can each be assigned to an internal command value. Here, it is first necessary to select to which controller (1...6) a valve output should be assigned. Assignment takes place using the parameter "Output reacts to command value of" on the parameter page "Output x -> Ax - General -> Ax - Command value/Status/Operating mode". In the "No internal command value" setting, the internal group communication of the selected valve output is deactivated. In the second step, the required command value of the selected controller must be selected using the parameter "Command value for valve output". This makes it possible, depending on the application, to assign any valve outputs to available internal command values (Figure 9).

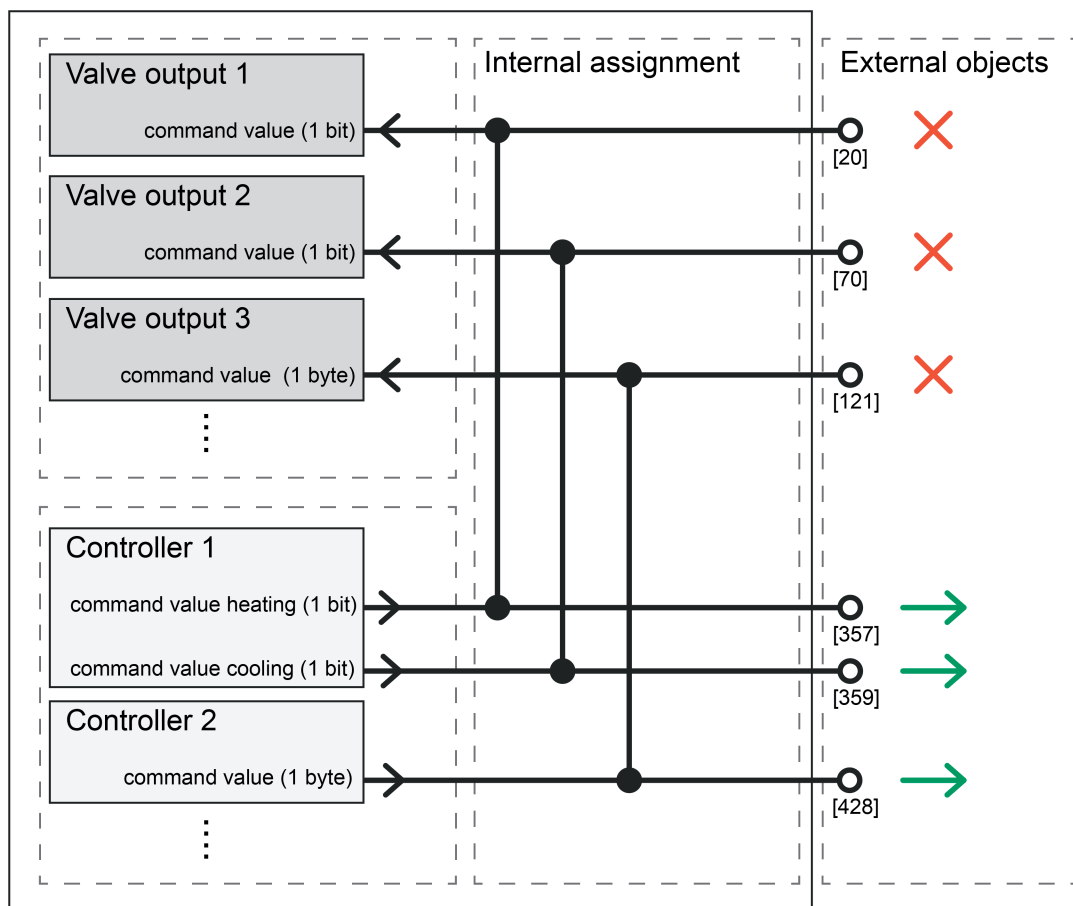

Figure 9: Project design example for internal group communication

- i** Each valve output can only be assigned to one command value. Command values from controllers can only then be assigned to a valve output when the data formats of the command value output (controller) and command value input (valve output) match. The application program in the ETS only offers command values which have the right data format.

Internal group communication uses internal group addresses to link the available communication objects of valve outputs and controllers. This renders external linking via group addresses superfluous. The internal group addresses are not directly visible. Management takes place automatically using the application program.

The communication objects are visible as usual in the object view in the ETS project.

In addition to internal group communication, it is possible to assign external group addresses to the communication objects in the ETS project. This is sensible, for example, if the command value outputs of the controllers are also to be sent to the KNX, in order to include other KNX actuators in the control. Use of internal and external group communication is thus possible for sending objects.

**Caution:**

For objects receiving values or states from the bus, when using internal group communication, prevent external communication from also taking place. It is therefore not permitted to link the 1-bit or 1-byte command value inputs of the valve outputs with external group addresses if internal command values have been assigned!



## 4.2.4.2 Channel-oriented functional description

### 4.2.4.2.1 Valve direction of action

The heating actuator possesses 6 electronic outputs, each of which can silently activate up to 4 (AC 230 V) or 2 (AC 24 V) actuators. Both deenergised closed and deenergised opened actuators can be connected. The parameter "Valve in voltage-free state (valve direction of action)" on the parameter pages "Ax - General" specifies which device type is connected to a valve output.

**i** Only actuators with the same characteristics may be connected to each valve output (deenergised closed/opened). The drive type must match the configuration.

The configured valve direction of action is taken into account in each valve activation. With 1-byte command values and deenergised closed valves, the switch-on time is derived directly from the configured PWM and the cycle time.

Example: PWM = 30 %, cycle time = 10 minutes -> Switch-on time = 3 minutes, switch-off time = 7 minutes.

In the case of 1-byte command values and deenergised opened valves, the switch-on time is inverted. Example: PWM = 30 %, cycle time = 10 minutes -> Switch-on time = 7 minutes, switch-off time = 3 minutes.

On deenergised closed valve drives, command values are not inverted, in accordance with the 1-bit data format. Example: Command value ON -> Output switched on, Command value OFF -> Output switched off.

By contrast, switching command values are inverted for deenergised opened valve drives. Example: Command value ON -> Output switched off, Command value OFF -> Output switched on.

**i** On the LED status display, the valve direction of action configured for each output in the ETS is not taken into account. As a result, the LEDs do not immediately display the valve state (opened / closed). Inversion of the status display according to the valve direction of action thus does not take place.

**i** In the state as supplied, the valve direction of action for all the valve outputs is set to "Deenergised closed".

#### 4.2.4.2.2 Reset behaviour

The states of the valve outputs after a bus voltage failure, bus or mains voltage return or after an ETS programming operation can be set separately.

##### Setting the behaviour in case of bus voltage failure

The parameter "Behaviour in case of bus voltage failure" is available separately for each valve output on the parameter page "Ax - General". The actuator executes the behaviour configured in the ETS when the bus voltage fails but the mains voltage supply is still available without interruption. If the bus and mains voltage supply fails simultaneously, then the valve outputs will not display the configured behaviour. In this case, even if valve voltage is available, the outputs will always switch off, as the device electronics are no longer being supplied with energy and, as a result, the actuator is unable to function. In this state of operation, deenergised closed valve drives close completely and deenergised opened valve drives open. The configured valve direction of action can no longer be evaluated if the bus and mains voltage fail.

**i** If only the mains voltage supply fails but the bus and valve voltage remain, then the actuator will not show a reaction.

- Set the parameter to "No change".

A bus voltage failure and mains voltage supply does not produce a reaction from the valve output. The command value active before the bus voltage failure remains unchanged, provided that the valve voltage supply is still switched on.

- Set the parameter to "Preset command value".

The actuator sets the command value preset for the valve output by the parameter "Command value on bus voltage failure". For valve outputs configured in the ETS to the command value data formats "Switching (1-bit)" or "Constant (1-byte) with command value limiting value", a constant command value can also be preset using the parameter "Command value on bus voltage failure". In this case, a pulse width modulation (5 % ... 95 %) is executed for the affected command value outputs. In the "0 %" and "100 %" presettings, the valve outputs are activated continuously. The preset PWM remains active until other functions (manual operation, short-circuit/overload) have been executed, which may override the constant command value on the valve output.

- Set the parameter to "Activate command value as for forced position".

For the valve output, the actuator polls the command value preset for the forced position, as configured in the ETS. Here, the active operating mode (summer / winter) is taken into account, providing that a summer / winter change-over is configured. Ensure that, in this setting, the forced position function is not executed! The actuator only polls the command value preset for the forced position.

- Set the parameter to "Activate command value as for emergency operation".

For the valve output, the actuator polls the emergency operation command value, as configured in the ETS. Here, the active operating mode (summer / winter) is taken into account, providing that a summer / winter change-over is configured. Ensure that, in this setting, emergency operation is not executed (as would be the case if there was a faulty command value found in the course of command value monitoring)! The actuator only polls the command value preset for emergency operation.

**i** If there is a bus voltage failure, the actuator saves the active command value internally in the device, so that the command value can be restored when the device power supply returns (configurable). Saving only takes place after a previous device reset (ETS programming operation, bus voltage return) when the reset is longer than 30 seconds previously. Otherwise the actuator does not save the current command value! In that case, an old value remains valid, as was previously saved by the actuator on the bus voltage failure. If only the mains power supply fails, the actuator does not save the command value.

- i** If the bus voltage fails while a manual operation on the device is activated, the parameter "Behaviour in case of bus voltage failure" is not executed.

### Behaviour after bus or mains voltage return presetting

The parameter "Behaviour after bus or mains voltage return" is available separately for each valve output on the parameter page "Ax - General".

- Set the parameter to "Preset command value".

The actuator sets the command value preset for the valve output by the parameter "Command value after bus or mains voltage return". For valve outputs configured in the ETS to the command value data formats "Switching (1-bit)" or "Constant (1-byte) with command value limiting value", a constant command value can also be preset using the parameter "Command value after bus or mains voltage return". In this case, a pulse width modulation (5 % ... 95 %) is executed for the affected command value outputs. In the "0 %" and "100 %" presettings, the valve outputs are activated continuously. The preset PWM remains active until other functions have been executed or a new command value telegram is received via the bus, overriding the constant command value on the valve output.

- Set the parameter to "Activate command value as for forced position".

For the valve output, the actuator polls the command value preset for the forced position, as configured in the ETS. Here, the active operating mode (summer / winter) is taken into account, providing that a summer / winter change-over is configured. Ensure that, in this setting, the forced position function is not executed! The actuator only polls the command value preset for the forced position.

- Set the parameter to "Activate command value as for emergency operation".

For the valve output, the actuator polls the emergency operation command value, as configured in the ETS. Here, the active operating mode (summer / winter) is taken into account, providing that a summer / winter change-over is configured. Ensure that, in this setting, emergency operation is not executed (as would be the case if there was a faulty command value found in the course of command value monitoring)! The actuator only polls the command value preset for emergency operation.

- Set the parameter to "Command value as before bus voltage failure".

After bus or mains voltage return, that command value is set at the valve output which was active at the moment of the last bus voltage failure. If there is a bus voltage failure, the actuator saves the active command value internally in the device, so that the command value can be restored when the device power supply returns. Saving only takes place after a previous device reset (ETS programming operation, bus voltage return) when the reset is longer than 30 seconds previously. Otherwise the actuator does not save the current command value! In that case, an old value remains valid, as was previously saved by the actuator on the bus voltage failure. If only the mains power supply fails, the actuator does not save the command value.

- i** A valve state set after bus/mains voltage return is added to the command value status objects. Actively transmitting feedback objects also only transmit after bus/mains voltage return, when the initialisation has finished, and if necessary the "Delay time after bus voltage return" has elapsed.

### Presetting the behaviour after ETS programming

The parameter "Behaviour after ETS programming" is available separately for each valve output on the parameter page "Ax - General". This parameter can be used to configure the behaviour of an output, irrespective of the behaviour after a bus/mains voltage return.

- Set the parameter to "Behaviour as after bus voltage return".

After an ETS programming operation, the valve output will behaviour in the manner defined in the parameter "Behaviour after bus or mains voltage return". If the behaviour there is configured to "Command value as before bus voltage failure", then that command value is also set after an ETS programming operation which was active at the time of the last bus voltage failure. An ETS programming operation does not overwrite the saved command value.

- Set the parameter to "Preset command value".

The actuator sets the command value preset for the valve output by the parameter "Command value after ETS programming operation". For valve outputs configured in the ETS to the command value data formats "Switching (1-bit)" or "Constant (1-byte) with command value limiting value", a constant command value can also be preset using the parameter "Command value after ETS programming operation". In this case, a pulse width modulation (5 % ... 95 %) is executed for the affected command value outputs. In the "0 %" and "100 %" presettings, the valve outputs are activated continuously. The preset PWM remains active until other functions have been executed or a new command value telegram is received via the bus, overriding the constant command value on the valve output.

- Set the parameter to "Activate command value as for forced position".

For the valve output, the actuator polls the command value preset for the forced position, as configured in the ETS. Here, the active operating mode (summer / winter) is taken into account, providing that a summer / winter change-over is configured. Ensure that, in this setting, the forced position function is not executed! The actuator only polls the command value preset for the forced position.

- Set the parameter to "Activate command value as for emergency operation".

For the valve output, the actuator polls the emergency operation command value, as configured in the ETS. Here, the active operating mode (summer / winter) is taken into account, providing that a summer / winter change-over is configured. Ensure that, in this setting, emergency operation is not executed (as would be the case if there was a faulty command value found in the course of command value monitoring)! The actuator only polls the command value preset for emergency operation.

- ❗ The behaviour after an ETS programming operation is only executed if there have been changes in the configuration of the device. If just an application download is executed with a project design already located in the actuator, then the actuator will execute the configured "Behaviour after bus or mains voltage return".
- ❗ An ETS programming operation can also be performed without mains voltage. The mains voltage supply is not required for an ETS download.
- ❗ A valve state set after an ETS programming operation is added to the command value status objects. Actively transmitting feedback objects also only first transmit after an ETS programming cycle when the initialisation has finished and, if necessary, the "delay time after bus voltage return" has elapsed.
- ❗ An active manual mode will be terminated by an ETS programming operation.

#### 4.2.4.2.3 Data formats for command values

The heating actuator receives 1-bit or 1-byte command value telegrams, transmitted, for example, by KNX room temperature controllers. Usually, the room temperature controller determines the room temperature and generates the command value telegrams using a control algorithm. The actuator controls its valve outputs either in switching form or with a PWM signal, according to the data format of the command values and the configuration in the ETS. The cycle time for constant PWM output signals can be configured separately for each valve output of the heating actuator. This allows individual adaptation to different actuator types.

- i** It should be noted that the heating actuator does not carry out temperature control itself. The actuator converts received command value telegrams or command value presets from device functions into constant or switching output signals.

The "Data format of the command value input" parameter, which is available separately for each valve output on the parameter pages "Ax - Command values/Status/Operating mode", specifies the input format of the command value objects.

#### Data format of the command value input "Switching (1-bit)"

In the case of a 1-bit command value, the telegram received via the command value object is forwarded directly to the appropriate output of the actuator, taking the configured valve direction of action into account. This means that, if an "ON" telegram is received, the valve is completely opened. The output is then energised for energised closed valves and the output is deenergised for energised opened valve drives. The valve is closed completely when an "OFF" telegram is received. The valve output is then not energised for deenergised closed valves and energised for deenergised opened valve drives.

In the functions and events listed below, valve outputs configured to the command value data formats "Switching (1-bit)" are always activated by a constant command value with pulse width modulation (PWM), provided that command values not equal to 0 % or 100 % are to be set...

- Active forced position,
- Active emergency operation,
- On bus voltage failure,
- After bus or mains voltage return,
- After an ETS programming operation,
- During a manual operation.

PWM keeps being executed until the named functions have been exited or, after the named events, no more lower-level functions are active and a new command value telegram is received via the bus, overriding the constant command value on the valve output.

- i** In the named cases, the constant command value is also included in the calculation of the largest command value and that of the heat requirement and pump control (optional functions).
- i** Valve outputs, which receive preset command values via the data format "Switching (1-bit)", influence the heat requirement and pump control. Here, an "OFF" command value is interpreted as "0 %" and an "ON" command value as "100 %".

#### Data format of the command value input "Constant (1-byte) with pulse width modulation (PWM)"

Command values corresponding to the data format "Constant (1-byte)" are implemented by the actuator with an equivalent pulse-width-modulated switch signal at the valve outputs. Taking the cycle time settable in the actuator for each output into account, the average output signal resulting from this modulation is a measure of the centred valve position of the control valve and thus a reference for the set room temperature. A shift of the mean value, and thus a change in the heating capacity, can be obtained by changing the duty factor of the switch-on and switch-off pulses of the output signal (Figure 10). The duty factor is adapted constantly by the actuator,

depending on the command value received (normal operation) or by active device functions (e.g. manual operation, forced position, emergency operation).

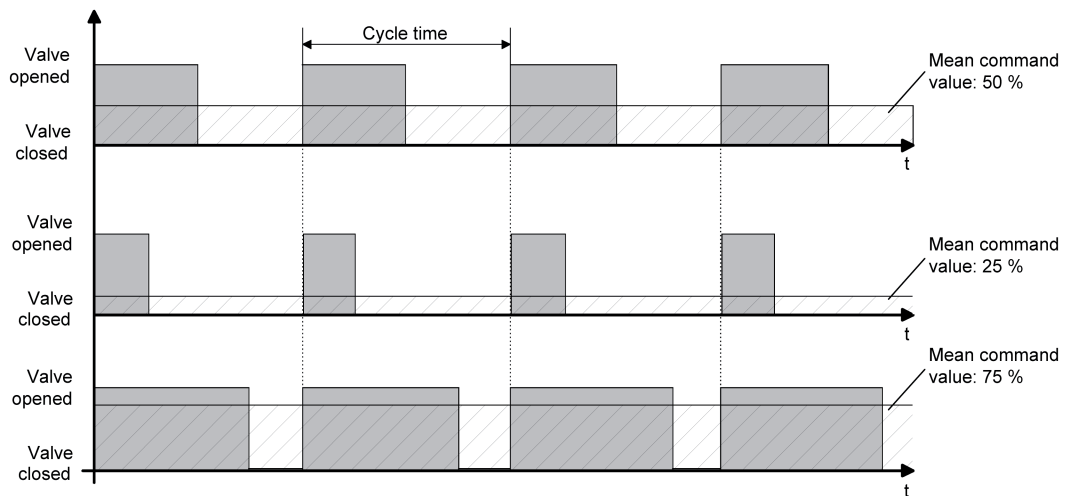

Figure 10: Resulting mean value through variable duty factor with pulse width modulation

In accordance with the configured valve direction of action, the appropriate outputs are either energised or deenergised, depending on the valve position to be approached. In so doing, the duty factor is inverted automatically for a deenergised opened drive. Thus, depending on the valve type used, there is no unintended mean value shift.

Example: Command value: 60 % ->

- Duty factor, deenergised closed: 60 % ON, 40 % OFF,
- Duty factor, deenergised opened: 40 % ON, 60 % OFF.

Example: Command value: 100 % ->

- Duty factor, deenergised closed: Permanently ON,
- Duty factor, deenergised opened: Permanently OFF.

Often, control circuits are subject to non-constant changes in the setpoint presetting (e.g. frost protection, night operation, etc.) or short-time interference (e.g. measured value deviations due to brief opening of windows or doors near the sensor). For the setting of the scanning ratio of the required command value to take place as quickly and correctly in these cases, even with a longer set cycle time, without any negative impact on the reaction time of the control section, the actuator uses a special method for continuous command value adjustment.

The following cases are taken into account...

- Case 1  
Command value change, e.g. from 80 % to 30 %, during the opening phase of the valve (Figure 11).  
Before the reception of the new command value (30 %), the old setpoint (80 %) was active. The new command value is received during the opening phase of the valve. At this point, the actuator detects that it is still possible to shorten the opening phase, so that it corresponds to the new command value (30 %). The cycle time is not affected by this operation.  
The new duty factor is set immediately after the reception of the new command value.

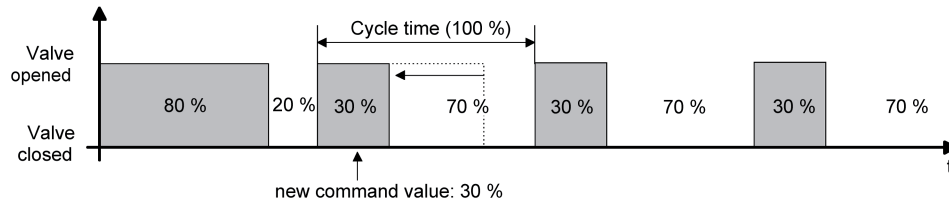

Figure 11: Example of a command value change 80 % -> 30 % during the opening phase of the valve

- **Case 2**

Command value change, e.g. from 80 % to 30 %, during the closing phase of the valve (Figure 12).

Before the reception of the new command value (30 %), the old setpoint (80 %) was active. The new command value is received during the closing phase of the valve. At this point, the actuator detects that it is still possible to extend the closing phase, so that it corresponds to the new command value (30 %). The cycle time remains unchanged, but the starting time of the period is shifted automatically.

The new duty factor is set immediately after the reception of the new command value.

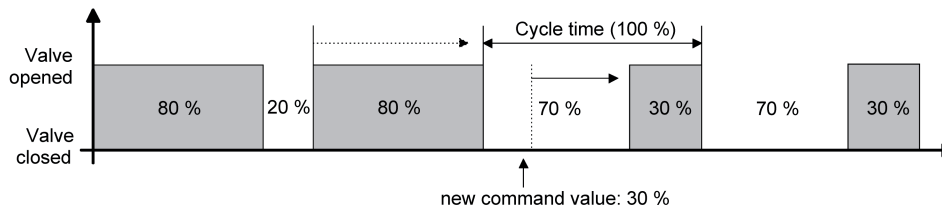

Figure 12: Example of a command value change 80 % -> 30 % during the closing phase of the valve

- **Case 3**

Command value change, e.g. from 80 % to 30 % during the opening phase of the valve (opening phase too long) (Figure 13).

Before the reception of the new command value (30 %), the old setpoint (80 %) was active. The new command value is received during the opening phase of the valve. At this point, the actuator detects that it is necessary to cancel the opening phase immediately and close the valve, so that the duty factor corresponds to the new command value (30 %). The cycle time remains unchanged, but the starting time of the period is shifted automatically.

The new duty factor is set immediately after the reception of the new command value.

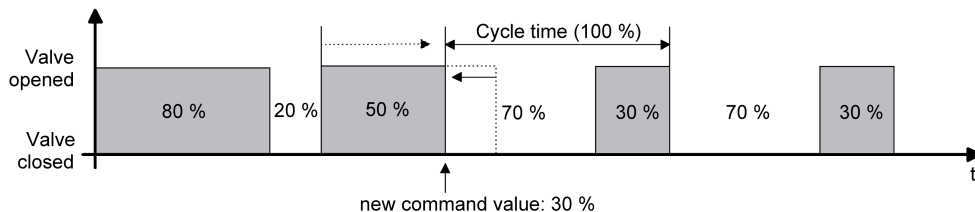

Figure 13: Example of a command value change 80 % -> 30 % during the opening phase of the valve (opening phase too long)

- Case 4  
 Command value change, e.g. from 30 % to 80 %, during the opening phase of the valve (Figure 14).  
 Before the reception of the new command value (80 %), the old setpoint (30 %) was active. The new command value is received during the opening phase of the valve. At this point, the actuator detects that it is still possible to extend the open phase, so that it corresponds to the new command value (80 %). The cycle time is not affected by this operation. The new duty factor is set immediately after the reception of the new command value.

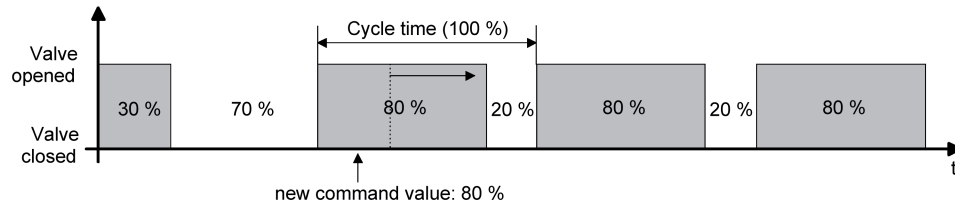

Figure 14: Example of a command value change 30 % -> 80 % during the opening phase of the valve

- Case 5  
 Command value change, e.g. from 30 % to 80 %, during the closing phase of the valve (Figure 15).  
 Before the reception of the new command value (80 %), the old setpoint (30 %) was active. The new command value is received during the closing phase of the valve. At this point, the actuator detects that it is still possible to reduce the closing phase, so that it corresponds to the new command value (80 %). The cycle time remains unchanged, but the starting time of the period is shifted automatically. The new duty factor is set immediately after the reception of the new command value.

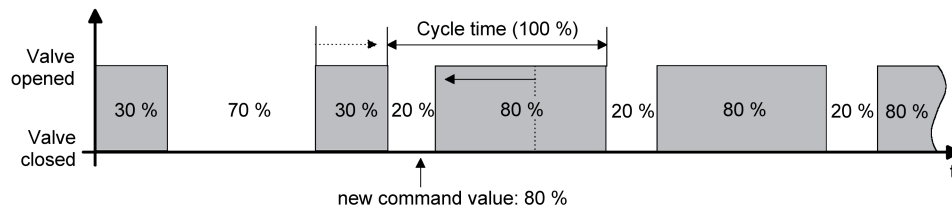

Figure 15: Example of a command value change 30 % -> 80 % during the closing phase of the valve

- Case 6  
 Command value change, e.g. from 30 % to 80 %, during the closing phase of the valve (closing phase too long) (Figure 16).  
 Before the reception of the new command value (80 %), the old setpoint (30 %) was active. The new command value is received during the closing phase of the valve. At this point, the actuator detects that it is necessary to cancel the closing phase immediately and open the valve, so that the duty factor corresponds to the new command value (80 %). The cycle time remains unchanged, but the starting time of the period is shifted automatically. The new duty factor is set immediately after the reception of the new command value.



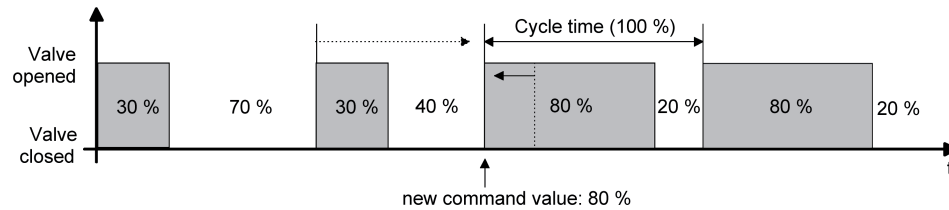

Figure 16: Example of a command value change 30 % -> 80 % during the opening phase of the valve (opening phase too long)

### Data format of the command value input "Constant (1-byte) with command value limiting value"

The data format with limiting value evaluation can be used as an alternative to the conversion of a 1-byte command value into constant pulse width modulation at a valve output. Here, the received constant command value is converted into a switching output signal, depending on the configured limiting value. The actuator opens when the command value reaches the limiting value or exceeds it (Figure 17). A hysteresis is also evaluated to prevent constant closing and opening of the actuator for command values in the area of the limiting value. The actuator only closes when the command value undershoots the limiting value minus the configured hysteresis.

The 1-byte data format with limiting value evaluation allows the conversion of constant feedback control by the heating actuator into a two-point controller. This principle is particularly suitable for underfloor heating, in which constant valve activation does not produce the desired heating reaction, on account of the sluggishness. With sluggish underfloor heating systems, small constant command values (only short switch-on phases of the PWM) frequently do not produce any significant level of heating. With large constant command values, the short switch-off phases of a PWM usually have no effect on underfloor heating systems or comparable heating systems. Here, two-point feedback control offers a simple, effective alternative. The valves open or close completely. During activation, unnecessary constant valve positions are avoided using command value telegrams. In addition, the service life of the electrothermal actuators is increased.

The conversion of the constant input signal into a switching command value takes place internally in the device. During processing, the actuator evaluates the converted command value as if it were a received 1-bit command value. It forwards the status directly to the appropriate output, taking the configured valve direction of action into account. Thus, on a "Open valve" command (received command value  $\geq$  limiting value), the valve is opened completely. The output is then energised for energised closed valves and the output is deenergised for energised opened valve drives. On a "Close valve" command (received command value  $<$  limiting value - hysteresis), the valve is closed completely. The valve output is then not energised for deenergised closed valves and energised for deenergised opened valve drives.

As with a 1-bit input command value, in the functions and events listed below, valve outputs configured to the command value data formats "Constant (1-byte) with command value limiting value" are always activated by a constant command value with pulse width modulation (PWM), provided that command values not equal to 0 % or 100 % are to be set...

- Active forced position,
- Active emergency operation,
- On bus voltage failure,
- After bus or mains voltage return,
- After an ETS programming operation,
- During a manual operation.

PWM keeps being executed until the named functions have been exited or, after the named events, no more lower-level functions are active and a new command value telegram is received via the bus, overriding the constant command value on the valve output.

- i** In the named cases, the constant command value is also included in the calculation of the largest command value and that of the heat requirement and pump control (optional functions).
- i** Valve outputs, which receive preset command values via the data format "Switching (1-byte) with command value limiting value", influence the heat requirement and pump control. Here, the actuator evaluates the converted switching output signal in the same way ("OFF" is interpreted as "0 %", "ON" is interpreted as "100 %").

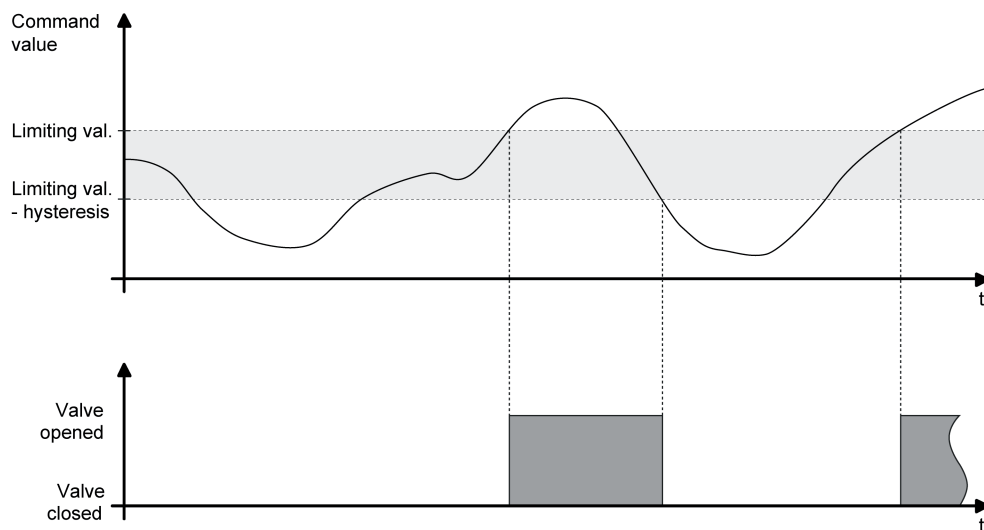

Figure 17: Example of command value evaluation with limiting value

#### 4.2.4.2.4 Cycle time

The "Cycle time" parameter specifies the period length of the pulse-width-modulated output signal of a valve output. It allows adaptation to the adjusting cycle times (the adjusting time it takes the drive to bring the valve from its completely closed to its completely opened position) of the actuators used. In addition to the adjusting cycle time, take account of the dead time (the time in which the actuators do not show any response when being switched or off). If different actuators with different adjusting cycle times are used at an output, take account of the longest of the times.

- i The "Cycle time" parameter is also available for valve drives, whose command value data format is configured to "Switching (1-bit)" or "Constant (1-byte) with command value limiting value". For such valve outputs, pulse width modulation can also be executed during an active forced position, emergency operation, manual operation, bus voltage failure, after bus or mains voltage return or after an ETS programming operation, for which, as a result, the presetting of a cycle time is required.

Generally, two different options of how to set the cycle time can be identified:

##### Case 1

Cycle time > 2 x Adjusting cycle time of the drives used (ETA)

In this case, the switch-on and switch-off times of the actuator are long enough for the actuators to have sufficient time to fully open and fully close within a given period (Figure 18).

- Advantage:  
The desired mean value for the command value and thus for the required room temperature will be set relatively precisely, even for several actuators triggered at the same time.
  - Disadvantage:  
It should be noted, that, due to the full valve lift, the life expectancy of the actuators can diminish. For very long cycle times (> 15 minutes) with less sluggishness in the system, the heat emission into the room, for example, in the vicinity of the radiators, can possibly be non-uniform and be found disturbing.
- i This cycle time setting is recommended for slower, more sluggish heating systems (such as underfloor heating).
  - i Even for a bigger number of triggered actuators, maybe of different types, this setting can be recommended to be able to obtain a better mean value of the adjusting travels of the valves.

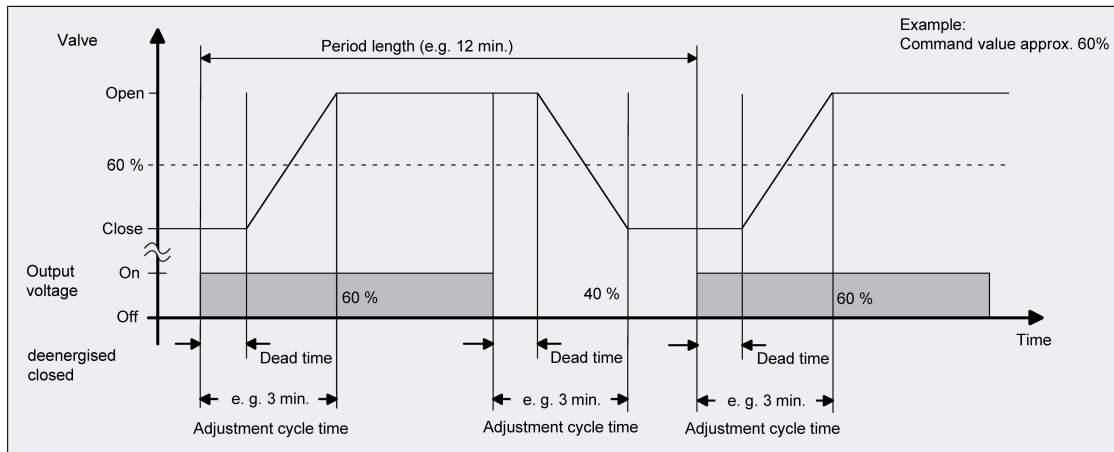

Figure 18: Ideal course of the valve stroke for a cycle time > 2 x Adjustment cycle time

## Case 2

Cycle time < Adjusting cycle time of the drives used (ETA)

In this case, the switch-on and switch-off times of the actuator are too short for the actuators to have enough time to fully open and fully close within a given period (Figure 19).

- Advantage: This setting ensures continuous water flow through the radiators, thus facilitating uniform heat emission into the room. If only one actuator is triggered the regulator can continuously adapt the variable to compensate the mean value shift caused by the short cycle time, thus setting the desired room temperature.
- Disadvantage: If more than one actuator is activated at the same time, the desired mean value will become the variable, which will result in a very poor adjustment of the required room temperature, or in adjustment of the latter with major deviations, respectively.

**i** This setting is recommended for quicker heating systems (such as radiators).

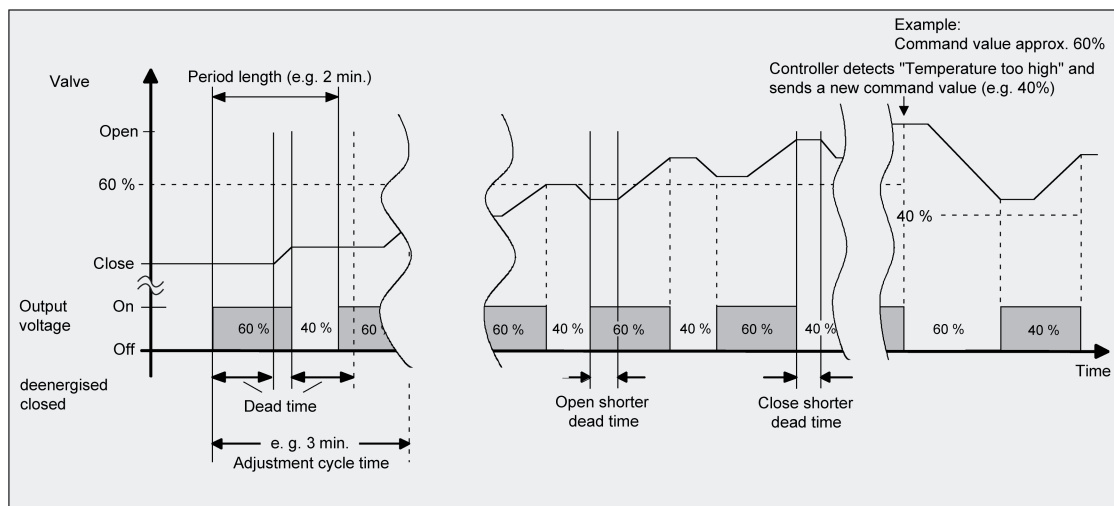

Figure 19: Ideal course of the valve stroke for a cycle time < Adjustment cycle time

The continuous flow of water through the valve, and thus the continuous heating of the drives causes variations and changes to the dead times of the drives during the opening and closing

phase. The short cycle time and the dead times means that the required command value (mean value) is only set with a possibly large deviation. For the room temperature to be regulated constantly after a set time, the controller must continually adjust the command value to compensate for the mean value shift caused by the short cycle time. Usually, the control algorithm implemented in the controller (PI control) ensures that control deviations are compensated.

## 4.2.4.2.5 Forced position

A forced position can be configured separately for each valve output and activated according to requirements. If a forced position is active, a defined command value is set at the output.

Affected valve outputs are then locked so that they can no longer be activated using functions subject to the forced position (including activation by command value telegrams).

The command value of the forced position is always constant and is configured individually in the ETS (0...100 % in 10 % steps). The command value is executed electrically at the output using a pulse width modulation (PWM).

- i** When a forced position is active, valve outputs configured to the command value data formats "Switching (1-bit)" or "Constant (1-byte) with command value limiting value" are always activated by a constant command value with pulse width modulation. In this case, this constant command value is also included in the calculation of the largest command value (optional function) until the forced position is exited and no other function with a constant command value presetting (e.g. emergency operation, manual operation) is active.
- i** The configured valve direction of action (deenergised closed / deenergised opened) is taken into account in the electrical activation of the outputs by a forced position. With deenergised closed valves, the switch-on time is derived directly from the configured PWM and the cycle time. In the case of deenergised opened valves, the switch-on time is inverted.

The actuator possesses a summer / winter switch-over. Depending on the season, this allows the setting of different command value setpoints for a valve output for forced position (see page 68). It is also possible to switch over the operating mode during an active forced position. In this case, the value belonging to the operating mode is activated immediately after the switch-over.

If no summer / winter switch-over is planned in the actuator, then only a command value can be configured in the ETS for the forced position.

For each valve output, the forced position is activated and deactivated via a separate 1-bit object. The telegram polarity can be configured. According to the priority control, an active forced position can be overridden by other device functions with a higher priority (e.g. service mode, manual operation). At the end of a higher priority function, the actuator executes the forced reaction for the valve outputs concerned once again if the forced position is still activated at this time.

Optionally, the command value of the forced position can also be activated in case of bus voltage failure, after bus/mains voltage return or after an ETS programming operation. This is only the recall of the configured command value and not the activation of the forced position as takes place via the 1-bit object.

- i** The command value preset by an active forced position is also included in the determination of heat requirement. In addition, the command value of the forced position has an influence on the pump control.

At the end of a forced position, the behaviour of a valve output is permanently defined. For the affected valve outputs, the actuator always tracks the state most recently preset by functions with a lower priority (emergency operation) or by normal bus operation (activation by command value telegrams).

- i** After a device reset (bus/mains return, ETS programming operation), the command value objects first contain the value "0".

### Enabling the forced position object and configuring the forced position

For the forced position to be used as a locking function, it must first be enabled in the ETS on the parameter page "Ax - Command value/Status/Operating mode" and be visibly switched by the communication object.

- Set the parameter "Use object for forced position ?" to "yes". Define the parameter "Polarity of 'Forced position' object" to the required telegram polarity. In addition, configure the required command values (optional for summer and winter mode).

The forced position object is enabled. The affected valve output is locked by a telegram according to the "Forced operation active" polarity at the defined command value (optional according to the most recently preset operating mode).
- Set the parameter "Use object for forced position ?" to "no".

The forced position object is not enabled. The forced position for locking the valve output is not possible. Only the command values can be configured, so that a state for the reset behaviour of the valve output can be optionally defined.
  
- ❗ Updates of the object from "Forced position active" to "Forced position active" or from "Forced position inactive" to "Forced position inactive" produce no reaction.
- ❗ The status preset via the forced position object is stored internally in the device after a bus voltage failure and is restored automatically after a bus and/or mains voltage return. After a bus/mains voltage return, the actuator activates the forced position, thus locking the output, if the tracked state allows this. However, when presetting the command values, only that behaviour is significant, according to the priority sequence, which the parameter "Behaviour after bus or mains voltage return" devices (the command value of the forced position is not activated).

The tracked state of the forced position is not then automatically tracked in the communication object by the actuator.
- ❗ After an ETS programming operation, a forced position is always deactivated and the forced position object is "0". In the polarity "0" = Forced position active / "1" = No forced position, a "0" telegram must first be received to activate the forced position. If, after a bus/mains voltage return, the previously stored object value "0" is restored, then actuator will also activate the forced position in the polarity "0 = Forced position active / 1 = No forced position", thus locking the output.
- ❗ If the forced position object is not enabled, then only the command value parameters are available, so that valid preset values are available for the actuator reset behaviour, as required ("Activate command values as for forced position").

#### 4.2.4.2.6 Cyclical command value monitoring / emergency operation

If necessary, cyclical monitoring of the command values can be performed. If, during active cyclical monitoring, there are no command value telegrams during a preset time, then emergency operation is activated for the affected valve output, for which a configurable constant PWM command value can be preset in the ETS.

The command value of emergency operation is always constant and is configured individually in the ETS (0...100 % in 10 % steps). The command value is executed electrically at the output using a pulse width modulation (PWM).

- i** When emergency operation is active, valve outputs configured to the command value data formats "Switching (1-bit)" or "Constant (1-byte) with command value limiting value" are always activated by a constant command value with pulse width modulation. In this case, this constant command value is also included in the calculation of the largest command value (optional function) until the emergency operation is exited and no other function with a constant command value presetting (e.g. forced position, manual operation) is active.
- i** The configured valve direction of action (deenergised closed / deenergised opened) is taken into account in the electrical activation of the outputs by emergency operation. With deenergised closed valves, the switch-on time is derived directly from the configured PWM and the cycle time. In the case of deenergised opened valves, the switch-on time is inverted.

The actuator possesses a summer / winter switchover. Depending on the season, this allows the setting of different command value setpoints for a valve output for emergency operation (see page 68). It is also possible to switch over the operating mode during active emergency operation. In this case, the value belonging to the operating mode is activated immediately after the switch-over.

If no summer / winter switch-over is planned in the actuator, then only a command value can be configured in the ETS for emergency operation.

If command value monitoring is enabled, then the actuator will check the arrival of telegrams on the command value object during a settable time period. The time period is defined separately for each valve output by the "Monitoring time" parameter. The time set there should be at least double the time for the cyclical transmission of the command value of the controller, in order to ensure that at least one telegram is received within the monitoring time. Cyclical command value monitoring takes place continuously. The actuator retriggers the monitoring time automatically on each command value telegram received and after a device reset. If there are no command value telegrams during the monitoring time, then the actuator will activate emergency operation.

- i** If the bus control of a valve output was disabled during permanent manual operation, then no command value monitoring is performed for the affected output. This exits active emergency operation. When bus control is enabled by a permanent manual operation, the actuator restarts the monitoring time and checks for incoming command value telegrams.

According to the priority control, active command value monitoring can be overridden by other device functions with a higher priority (e.g. service mode, manual operation). At the end of a higher priority function, the actuator executes emergency operation for the valve outputs concerned once again, if it is still activated by missing command value telegrams.

Optionally, the command value of emergency operation can also be activated in case of bus voltage failure, after bus/mains voltage return or after an ETS programming operation. This is only the recall of the configured command value and not the activation of emergency operation, as takes place during command value monitoring.

- i** The command value preset by active emergency operation is also included in the determination of heat requirement. In addition, the command value of emergency operation has an influence on the pump control.

At the end of emergency operation (new input command value received), the behaviour of a valve output is permanently defined. If no function with a higher priority is active, the actuator always tracks the state for the affected valve outputs most recently preset by normal bus operation (activation by command value telegrams).

- i** After a device reset (bus/mains voltage return, ETS programming operation), the command value objects first contain the value "0".



- i** The state or emergency operation (active or inactive) is saved internally in the device after a bus voltage failure and is restored automatically after a bus and/or mains voltage return. After a bus/mains voltage return, the actuator activates emergency operation, if the tracked state allows this.

The actuator makes the 1-bit status telegram "Command value fault" available. As soon as a command value telegram is missing on a monitored valve output, and thus emergency operation is activated, then the actuator transmits a fault signal via this status object. The telegram polarity can be configured. Only after at least one command value telegram has been received for the monitored valve output does the actuator retract the fault signal for cyclical monitoring. Optionally, the fault telegram can also be transmitted cyclically during active emergency operation.

- i** Immediately after the bus voltage return or an ETS programming operation, the object "Command value fault" does not transmit the status automatically. A faulty command value must be detected again (expiry of the monitoring time without a command value telegram) for the object value to be transmitted. This is also the case if a saved emergency operation was restored after a device reset.

### **Enable cyclical command value monitoring**

Cyclical command value monitoring can only be used if it has been enabled in the ETS.

- Set the parameter "Activate command value monitoring ?" on parameter page "Ax - Command value/Status/Operating mode" to "Yes". Configure the "Monitoring time" of the command value monitoring.

Cyclical command value monitoring is activated. If there are no command value telegrams during the monitoring time preset by the parameter of the same name, then emergency operation is activated for the affected valve output, for which the actuator sets to a configurable constant PWM command value. This command value is fined by the "Command value in the case of emergency operation..." parameter (if necessary, separately for summer and winter mode).

- Set the parameter "Activate command value monitoring ?" to "no".  
Cyclical command value monitoring is deactivated.

### **Configuring the fault signal for cyclical command value monitoring**

If a command value fault is identified, then the actuator can optionally transmit a fault telegram via the object "Command value fault".

- Set the parameter "Polarity of 'Command value fault' object" on parameter page "Ax - Command value/Status/Operating mode" to the required telegram polarity.

As soon as a command value telegram is missing on a monitored valve output, and thus emergency operation is activated, then the actuator transmits a fault signal via the status object "Command value fault" according to the configured telegram polarity. Only after at least one command value telegram has been received for the monitored valve output does the actuator retract the fault signal for cyclical monitoring.

- Set the parameter "Cyclical transmission in the case of faulty command value ?" to "yes".  
If a command value fault is identified, then the actuator transmits the fault telegram cyclically. The cycle time is defined for all cyclical status and feedback functions on the "General" parameter page.
- Set the parameter "Cyclical transmission in the case of faulty command value ?" to "no".

If a command value fault is identified, then the actuator transmits the fault telegram only once.

## 4.2.4.2.7 Command value limit

### Enabling the command value limit

The command value limit can only be used if it has been enabled in the ETS.

- Set the "Command value limit ?" parameter on parameter page "Ax - Command value/Status/Operating mode" to "Yes".  
The command value limit is enabled. The "Activation of the command value limit" parameter defines whether the limiting function can be activated or deactivated as required via a communication object. Alternatively, the command value limit can be permanently active.
- Set the "Command value limit ?" parameter to "no".  
The command value limit is not available.

### Setting the activation of the command value limit

The "Activation of the command value limit" parameter on the parameter page "Ax - Command value/Status/Operating mode" defines the mode of action of the limiting function.

The command value limit must be enabled.

- Set the parameter to "By object 'Command value limit'".  
The command value limit can only be activated using the 1-bit communication object "Command value limit" ("1" telegram) or deactivated ("0" telegram). The behaviour of the command value limit is definable separately after a device reset (bus voltage return, ETS programming operation).
- Set the parameter to "Permanently activated".  
The command value limit is permanently active. It cannot be influenced via an object. Command values preset via the KNX or via emergency operation are always limited.

### Setting the initialisation behaviour of the command value limit

The command value limit can either be activated or deactivated using the 1-bit communication object "Command value limit", or be permanently active. When controlling via the object, it is possible to have the actuator activate the command value limit automatically after bus voltage return or an ETS programming operation. The parameters "Activate command value limit after bus voltage return ?" and "Activate command value limit after ETS programming" define the initialisation behaviour.

-  With a permanently active command value limit, the initialisation behaviour cannot be configured after bus voltage return or an ETS programming operation, as the limit is always active. In this case, no object is available.

The command value limit must be enabled.

- Set the "Activate command value limit after bus voltage return ?" parameter to "no".  
The command value limit is not activated automatically after bus voltage return. A "1" telegram must first be received via the "Command value limit" object for the limiting function to be activated.
- Set the "Activate command value limit after bus voltage return ?" parameter to "yes".  
In this setting, the actuator does not activate the command value limit automatically after bus voltage return. To deactivate the limit a "0" telegram must be received via the "Command value limit" object. The limit can be switched on or off at any time using the object.
- Set the "Activate command value limit after ETS programming ?" parameter to "no".

The command value limit is not activated automatically after an ETS programming operation. A "1" telegram must first be received via the "Command value limit" object for the limiting function to be activated.

- Set the "Activate command value limit after ETS programming ?" parameter to "yes".

In this setting, the actuator activates the command value limit automatically after an ETS programming operation. To deactivate the limit a "0" telegram must be received via the "Command value limit" object. The limit can be switched on or off at any time using the object.

- i** The status of the command value limit is not automatically tracked in the communication object after a device reset.
- i** It should be checked that, on account of priority control, the actuator executed the behaviour configured by the parameters "Behaviour after bus or mains voltage return" and "Behaviour after an ETS programming operation" on the parameter page "Ax - General" after bus voltage return and an ETS programming operation. The command values preset via configuration after a device reset are not influenced by a command value limit. A command value limit only influences the input command values preset via the bus or emergency operation command values during command value monitoring.

#### 4.2.4.2.8 Status functions

##### Command value status

A status object can be optionally enabled for each valve output. The status object makes the active command value of a valve output available either actively transmitting or passively (object can be read out). During status feedback, the actuator takes all the functions into account which have an influence on the command value implemented at the output. Depending on the configured data format of the input command value, the status object will possess the data formats named below...

- Input command value "Switching (1-bit)":  
Data format of status object "1-bit",
- Input command value "Constant (1-byte) with pulse width modulation (PWM)":  
Data format of status object "1-byte",
- Input command value "Constant (1-byte) command value limiting value":  
Data format of status object "1-bit".

The status objects will assume different status values, depending on the input data formats of the command values and the state of operation of a valve output.

- i** The actuator distinguishes between different functions and events that can have an effect on the valve outputs. Because these functions and events cannot be executed simultaneously, there is priority control. Each global or output-orientated function and each incoming event possesses a priority (see page 54-55). The function or the event with the higher priority overrides the lower-priority functions and events. Priority control also influences the status objects. That state is always transmitted as the status which is currently set at a valve output. If a function with a high priority is exited, then the status objects assume the command value of functions with a lower priority, providing that they are active.

Status value for input command value "Switching (1-bit)"...

- State of operation "Normal operation"  
-> Status value = Most recently received input command value ("0" or "1"),
- State of operation "Emergency operation" (0...100 %)  
-> Status value = Emergency operation command value ("0" at 0 %, "1" at 1...100 %),
- State of operation "Forced position" (0...100 %)  
-> Status value = Forced command value ("0" at 0 %, "1" at 1...100 %),
- State of operation "Valve rinsing" (0 %, 100 %)  
-> Status value = Current command value in rinsing operation ("0" when valve closed, "1" when valve opened),
- State of operation "Service mode" (0 %, 100 %)  
-> Status value = Service command value ("0" when valve forcibly closed, "1" when valve forcibly opened),
- State of operation "After device reset" (0...100 %)  
-> Status value = According to presetting by parameter "Behaviour after bus or mains voltage return" or "Behaviour after ETS programming operation" ("0" at 0 %, "1" at 1...100 %),
- State of operation "Manual operation" (5...100 %)  
-> Status value = Manual operation command value ("0" at 0 % CLOSE, "1" at 5...100 % OPEN),
- State of operation "Valve voltage failure" (0 %, 100 %)  
-> Status value = Command value according to valve direction of action ("0" when deenergised closed, "1" when deenergised opened),
- State of operation "Short-circuit / overload" (0 %, 100 %)  
-> Status value = Command value according to valve direction of action ("0" when deenergised closed, "1" when deenergised opened).

Status value for input command value "Constant (1-byte) with pulse width modulation (PWM)"...

- State of operation "Normal operation" -> Status value = Most recently received input command value (0...100 %),
- State of operation "Emergency operation" (0...100 %)  
-> Status value = Emergency operation command value (0...100 %),
- State of operation "Forced position" (0...100 %)  
-> Status value = Forced command value (0...100 %),
- State of operation "Valve rinsing" (0 %, 100 %)  
-> Status value = Current command value in rinsing operation ("0 %" when valve closed, "100 %" when valve opened),
- State of operation "Service mode" (0 %, 100 %)  
-> Status value = Service command value ("0 %" when valve forcibly closed, "100 %" when valve forcibly opened),
- State of operation "After device reset" (0...100 %)  
-> Status value = According to presetting by parameter "Behaviour after bus or mains voltage return" or "Behaviour after ETS programming operation" ("0" at 0 %, "1" at 1...100 %),
- State of operation "Manual operation" (5...100 %)  
-> Status value = Manual operation command value (0 % CLOSE, 5...100 % OPEN),
- State of operation "Valve voltage failure" (0 %, 100 %)  
-> Status value = Command value according to valve direction of action (0 % when deenergised closed, 100 % when deenergised opened),
- State of operation "Short-circuit / overload" (0 %, 100 %)  
-> Status value = Command value according to valve direction of action (0 % when deenergised closed, 100 % when deenergised opened).

Status value for input command value "Constant (1-byte) command value limiting value"...

- State of operation "Normal operation"  
-> Status value = According to evaluation of the input command value by limiting value and hysteresis ("0" for command value < limiting value - hysteresis or "1" for command value >= limiting value),
- State of operation "Emergency operation" (0...100 %)  
-> Status value = Emergency operation command value ("0" at 0 %, "1" at 1...100 %),
- State of operation "Forced position" (0...100 %)  
-> Status value = Forced command value ("0" at 0 %, "1" at 1...100 %),
- State of operation "Valve rinsing" (0 %, 100 %)  
-> Status value = Current command value in rinsing operation ("0" when valve closed, "1" when valve opened),
- State of operation "Service mode" (0 %, 100 %)  
-> Status value = Service command value ("0" when valve forcibly closed, "1" when valve forcibly opened),
- State of operation "After device reset" (0...100 %)  
-> Status value = According to presetting by parameter "Behaviour after bus or mains voltage return" or "Behaviour after ETS programming operation" ("0" at 0 %, "1" at 1...100 %),
- State of operation "Manual operation" (5...100 %)  
-> Status value = Manual operation command value ("0" at 0 % CLOSE, "1" at 5...100 % OPEN),
- State of operation "Valve voltage failure" (0 %, 100 %)  
-> Status value = Command value according to valve direction of action ("0" when deenergised closed, "1" when deenergised opened),
- State of operation "Short-circuit / overload" (0 %, 100 %)  
-> Status value = Command value according to valve direction of action ("0" when deenergised closed, "1" when deenergised opened).

## Activating the command value status function

The status feedback is a function of the valve outputs and can be enabled on the parameter pages "Ax - Command value/Status/Operating mode".

- Set the "Feedback valve command value" parameter to "Yes".  
Status feedback is enabled. The status object of the valve output becomes visible in the ETS.
- Set the parameter to "no".  
Status feedback is deactivated. No status object is available.

## Setting the type of the command value status function

The status feedback can be used as an active signal object or as a passive status object. As an active signal object, the feedback is also directly transmitted to the bus whenever there is a change to the status value. As a passive status object, there is no telegram transmission after a change. In this case, the object value must be read out. The ETS automatically sets the communication flags of the status objects required for proper functioning.

The parameter "Type of feedback" exists separately for each valve output on the parameter page "Ax - Command value/Status/Operating mode".

Status feedback must be enabled.

- Set the parameter to "Active signalling object".  
The feedback telegram is transmitted as soon as the status changes. An automatic telegram transmission of the feedback takes place after bus voltage return, if the supply voltage of the actuators fails and returns or after an ETS programming operation (possibly with a delay).
- ❗ The status object does not transmit if the status does not change after the activation or deactivation of device functions or new input command values. Transmission only ever takes place after changes to the command value.
- Set the parameter to "Passive status object".  
The feedback telegram will only be transmitted in response if the status object is read out from the bus by a read telegram. No automatic telegram transmission of the feedback takes place after bus voltage return, if the supply voltage of the actuators fails and returns or after an ETS programming operation.

## Setting the time delay of the command value status feedback

If used as active signal object, the state of the status feedback information is transmitted to the bus after bus voltage return or after an ETS programming operation. In these cases, feedback can be time-delayed with the time delay being preset globally for all valve outputs together on the "General" parameter page.

- Set the parameter "Time delay for feedback after bus voltage return ?" to "yes".  
The status feedback will be transmitted with a delay after bus voltage return or after an ETS programming operation. No feedback is transmitted during a running time delay, even if the valve state changes during this delay.
- Set the parameter "Time delay for feedback after bus voltage return ?" to "no".  
The status feedback will be transmitted immediately after bus voltage return or after an ETS programming operation.
- ❗ If the supply voltage of the actuators fails and returns, then the status feedback is always transmitted without a delay, providing that the bus voltage supply is switched on.

## Setting cyclical transmission of the command value status feedback

The status feedback telegram can also be transmitted cyclically via the active signal object in addition to the transmission after changes.

- Set the parameter "Cyclical transmission of feedback telegram?" to "yes".  
Cyclical transmission is activated.
  - Set the parameter "Cyclical transmission of feedback telegram?" to "no".  
Cyclical transmission is deactivated so that the feedback telegram is transmitted to the bus only when the status is changed by the actuator.
- i** The cycle time is defined centrally for all the valve outputs on the parameter page "General".
- i** There is no cyclical transmission during an active time delay after bus voltage return or an ETS programming operation.

## Combined valve status

The combined valve status allows the collective feedback of various functions of a valve output in a single 1-byte bus telegram. It helps to forward the status information of an output to a suitable recipient (e.g. KNX visualisation) in a targeted manner, without having to evaluate various global and channel-orientated feedback and status functions of the actuator. The communication object "Feedback combined valve status" contains 7 different items of status information, which are bit-encoded (Figure 20).

Bits	7	6	5	4	3	2	1	0	
	Not assigned (always "0")								
	Forced position ("0" = Forced position active / "1" = No forced position)								
	Man. operation ("0" = No manual operation active / "1" = Perm. manual operation active)								
	Service mode ("0" = No service mode active / "1" = Service mode active)								
	Valve rinsing ("0" = No valve rinsing active / "1" = Valve rinsing active)								
	Overload ("0" = No overload / "1" = Overload identified)								
	Short-circuit ("0" = No short-circuit / "1" = Short-circuit identified)								
	Command value status ("0" = Command value OFF, 0 % / "1" = Command value ON, 1...100 %)								

Figure 20: Bit encoding of the object "Feedback combined valve status"

The bits of the combined valve status feedback have the meaning given below...

- Bit 0 "Command value status":  
The command value status always transmits the command value status currently set at a valve output. Here, the priority control of the actuator is taken into account. Functions or events with a higher priority override lower-level functions and events. If a function with a high priority is exited, then the status information assumes the command value of functions with a lower priority, providing that they are active.  
The active command value is always made available as 1-bit information in the combined object. Constant command values (PWM at the valve output) are converted into a 1-bit status (status "0" = Command value 0 % / status "1" = Command value 1...100 %).
- Bit 1 "Short-circuit":  
In this status bit, the value "1" forwards the information that the valve output has a short-circuit. The bit becomes "1" as soon as the actuator has successfully performed the testing cycle for short-circuit detection. The bit becomes "0" when the short-circuit has been eliminated and reset.



- Bit 2 "Overload":  
In this status bit, the value "1" forwards the information that the valve output has an electrical overload. The bit becomes "1" as soon as the actuator has successfully performed the testing cycle for overload detection. The bit becomes "0" when the overload has been eliminated and reset.
- Bit 3 "Valve rinsing":  
When "1", this bit indicates active valve rinsing (rinsing operation time running). In the "0" status, no valve rinsing is active.
- Bit 4 "Service mode":  
Service mode is a global function of the actuator. Individual valve outputs can be assigned to service mode. When "1", this bit displays an active service mode. The affected valve output then sets the command value of the service mode. In this case, the output is disabled for activation by the bus using input command values. In the "0" status, no service mode is active.
- Bit 5 "Manual operation":  
Manual operation is also a global function of the actuator. The command value of individual valve outputs can be influenced in the course of a manual operation. When "1", this bit displays an active permanent manual operation. In the "0" status, no manual operation is active. In a temporary manual operation, the status in the combined object does not become "1".
- Bit 6 "Forced position":  
When "1", this bit displays an active forced position. In the "0" status, no forced position is active.
- Bit 7 "Not assigned":  
This bit is always "0".

### Activating the combined valve status

The combined status feedback is a function of the valve outputs and can be enabled on the parameter pages "Ax - Command value/Status/Operating mode".

- Set the "Feedback combined valve status ?" parameter to "Yes".  
The feedback of the combined valve status is enabled. The 1-byte status object becomes visible in the ETS.
- Set the parameter to "no".  
The feedback of the combined valve status is deactivated. No 1-byte status object is available.

### Setting the type of the combined valve status

The combined valve status can be used as an active signal object or as a passive status object. As an active signal object, the feedback is also directly transmitted to the bus whenever there is a change to the status value. As a passive status object, there is no telegram transmission after a change. In this case, the object value must be read out. The ETS automatically sets the communication flags of the status objects required for proper functioning.

The parameter "Type of combined status feedback" exists separately for each valve output on the parameter page "Ax - Command value/Status/Operating mode".

The combined status feedback must be enabled.

- Set the parameter to "Active signalling object".  
The feedback telegram is transmitted as soon as the status changes. Automatic telegram transmission of the feedback takes place after bus voltage return and after an ETS programming operation (possibly with a time delay).

**i** The combined status object does not transmit if the status information does not change after the activation or deactivation of device functions or new input command values. Only changes are ever transmitted.

- i** If the supply voltage of the actuators fails and returns, then the combined status feedback is not transmitted.
  - Set the parameter to "Passive status object".

The feedback telegram will only be transmitted in response if the status object is read out from the bus by a read telegram. No automatic telegram transmission of the feedback takes place after bus voltage return or after programming with the ETS.

### Setting the time delay of the combined valve status

If used as active signal object, the state of the combined status feedback information is transmitted to the bus after bus voltage return or after an ETS programming operation. In these cases, feedback can be time-delayed with the time delay being preset globally for all valve outputs together on the "General" parameter page.

- Set the parameter "Time delay for feedback after bus voltage return ?" to "yes".

The combined status feedback will be transmitted with a delay after bus voltage return or after an ETS programming operation. No feedback is transmitted during a running delay, even if the status information changes during this delay.
- Set the parameter "Time delay for feedback after bus voltage return ?" to "no".

The combined status feedback will be transmitted immediately after bus voltage return or after an ETS programming operation.

### Setting cyclical transmission of the combined valve status

The feedback telegram of the combined valve status can also be transmitted cyclically via the active signal object in addition to the transmission after changes.

- Set the parameter "Cyclical transmission of feedback telegram?" to "yes".

Cyclical transmission is activated.
- Set the parameter "Cyclical transmission of feedback telegram?" to "no".

Cyclical transmission is deactivated so that the feedback telegram is transmitted to the bus only when the status is changed by the actuator.

**i** The cycle time is defined centrally for all the valve outputs on the parameter page "General".

**i** There is no cyclical transmission during an active time delay after bus voltage return or an ETS programming operation.

## 4.2.4.2.9 Short-circuit and overload detection

The actuator is able to detect an electrical overload or a short-circuit at the valve outputs and to protect them against destruction by switching off. Outputs which have experienced a short-circuit or a constant load are deactivated after an identification period. Optionally, in this case short-circuit/overload signals can be transmitted via separate 1-bit communication objects. Short-circuit / overload detection is always active when a valve output is switched on (output energised) and always occurs in two output groups. Here, outputs 1 to 3 and outputs 4 to 6 each form a group. If there is an error, the actuator will only detect an overload / a short-circuit in a group at first. Therefore, the actuator then executes a special testing cycle, which guarantees safe detection of the valve outputs which are actually electrically overloaded. Only after overloaded or short-circuited valve outputs have been accurately determined is it possible to output overload/short-circuit signals to the bus. After error detection in a group, all the outputs in this group are immediately deactivated for 6 minutes (switch-off idle phase / outputs not energised). During this time, the error detection circuit resets thermally.

The status LEDs **⚡A1-A3** or **⚡A4-A6** on the front panel of the device flash slowly during the time of an overload or short-circuit identification (1 Hz) to signalise that the output groups are temporarily deactivated. The LEDs flash quickly when the actuator has safely identified all or individual valve outputs of the affected group as overloaded or having short-circuited.

### Testing cycle

During the testing cycle, the actuator applies stepped, time-offset switch-on and deactivation of each valve output of the affected group to determine the outputs which are overloaded or shorted and which thus led to the error switch-off. In the case of a weak overload at, for example, one valve output, it may occur during the testing cycle that, during the individual testing of the output during the switch-on phase, no overload is detected, as the overload is too slight. This means that it may be necessary to start multiple testing cycles, until the overloaded output can be identified clearly. Each output group is equipped with a meter, which saves the number of testing cycles started for a group up to that point. Each time it is not possible to determine clearly if a valve output is overloaded or short-circuited during a testing cycle, then the counter will meter upwards by one increment. If another error is detected in an output group unsuccessfully tested for overload / short-circuit (meter reading > "0"), then the outputs will be energised with a longer switch-on time in the new testing cycle. In the first testing cycle, the switch-on time is 1 second, in the 2nd cycle 10 seconds, in the 3rd cycle 1 minute and, in the 4th cycle, 4 minutes.

The meter reading is only saved in the device and cannot be read out.

If there is a collective overload, various weak overloads, possibly at multiple outputs, have collected into a stronger overall overload. If there is a collective overload, it may occur that, even after four testing cycles, no output can be clearly identified as overloaded. In this case, after the fourth cycle, the actuator will deactivate individual valve outputs of an output group, until no overload exists.

Here is the testing cycle for the identification of overloaded or short-circuited valve outputs in detail...

- 1.  
An overload or short-circuit was detected in a group. The actuator deactivates all the valve outputs of the affected group. The switch-off idle phase (6 minutes) is started.
  
- 2.  
The first valve output of the affected group (output 1 or output 4) switches on for approx. 1 second, if this output was not previously deactivated by a previous testing cycle. If the output was previously deactivated, then the actuator switches the next output on (output 2 or output 4, etc.).

- 2. a  
If, during the switch-on time, no overload or no short-circuit is detected because the overload / the short-circuit is pending at another output or is too slight (weak overload), then the output will be switched off again. Continue with Step 3.
  
  - 2. b  
If, at the tested valve output, an overload or a short-circuit is detected, then a forced switch-off takes place immediately at this output. The output is deactivated. Then a switch-off idle phase of 6 minutes is started, during which the error detection circuit resets thermally. During this time, the affected output group remains completely switched off.
  
  - 3.  
The output test started under Step 2 is continued with the next output, which has not been deactivated, in the appropriate group in the same fashion, with a time gap of approx. 4 seconds from output test to output test, until the last valve output of the group or both groups has been processed.
  
  - 4.  
The testing cycle is then finally exited when all the valve outputs or both groups have been processed.
  
  - 4. a  
The valve outputs detected as overloaded or having shorted in the testing cycle of the group(s) now remain deactivated and cannot be switched on again until the reset. The testing cycle counter is deleted. All the unaffected valve outputs are again activated normally.
  
  - 4. b  
If, during the testing cycle, no output was detected as being overloaded or having shorted (probable weaker overload), then the testing cycle counter for this/these group(s) will count upwards, so that, in the next cycle, all the affected valve outputs are tested with an extended switch-on time, in order to detect weaker overloads.  
Exception: If the previously executed testing operation was the 4th sequence in succession without any error detection, then the actuator will assume that this is a collective overload at multiple outputs. In this case, the actuator will automatically deactivate one output of the affected group (output 3 or output 6), according to the priority. In so doing, the testing cycle counter will be deleted as for regular identification of an error, and testing again occurs with a 1 s switch-on time in the next cycle. If 4 cycles again occur after this, without outputs being detected as overloaded or having shorted during the individual test, then the actuator will again assume a collective overload and will automatically permanently deactivate the next outputs of the group(s) (firstly output 2 and/or output 5, then, after four more cycles, output 1 and/or output 4).
  
  - 5.  
All the valve outputs not deactivated in the testing cycles then continue to work normally.
- i** If possible, connect actuators for environments with increased fail-safety requirements to the outputs 1 and 4. During overload detection, these are switched off last, as described.
  - i** Signal telegrams, if configured for a valve output in the ETS, are only generated for those valve outputs which were forcibly deactivated by priority in the testing cycle, after the detection of an error or a collective overload.
  - i** The resetting of an overload or a short-circuit during a testing cycle is ignored.

- i** To give less weight to detected overloads caused by rare, extreme interference, such as strong electromagnetic coupling into the low-voltage network (lightning strike close by), the cycle counter is reduced by 1 after a period of 28 days without the detection of a further overload or a new short-circuit. This ensures that, after long periods of time, valve outputs are not simply switched off after the 4th cycle without identification of a clear overload or a short circuit.
- i** A valve output switched off via the bus (output not energised) can also be energised during the overload or short-circuit detection phase for the period of time defined in the testing cycle.

A short circuit or an overload influences the command value status of the valve outputs of an output group. Even at the beginning of a short-circuit / overload identification phase, the actuator will set the command value status, according to the valve direction of action, either to "OFF" / "0 %" (for deenergised closed) or to "ON" / "100 %" (for deenergised opened). This valve status remains intact during the entire length of the identification phase and for valve outputs identified as having short circuited or being overloaded. Energisation phases during the testing cycles do not influence the command value status.

- i** The command value status contained in the combined valve status is not influenced by a short-circuit or an overload.
- i** A valve output affected by a short-circuit / overload (valve completely closed on deenergised closed or completely opened on deenergised opened) does not influence the evaluation of the calculation of the "Largest command value" or the heat requirement and pump control.

Examples of overload / short-circuit detection...

Example 1

Error case = Short-circuit at valve output 4.

A short-circuit generates a short-circuit/overload signal in output group A4...A6. This produces the following sequence...

Test time	Outputs						KNX message						Comment
	1	2	3	4	5	6	1	2	3	4	5	6	
6min	N	N	N	0	0	0	-	-	-	-	-	-	Overload only affects one group!
<1s	N	N	N	1	0	0	-	-	-	T	-	-	Check output 4 4 s later → Short-circuit
6min	N	N	N	0	0	0	-	-	-	-	-	-	Switch-off idle phase. Short-circuit message
1s	N	N	N	0	1	0	-	-	-	-	-	-	Check output 5 → No error
1s	N	N	N	0	0	1	-	-	-	-	-	-	Check output 6 4 s later → No error
---	N	N	N	0	N	N	-	-	-	-	-	-	Output 4 remain deactivated 4 s later! All the other outp. contin. to work "normally"!

Figure 21: Short-circuit at valve output 4

- "0" Output not energised
- "1" Output energised
- "N" Normal operation of the valve output
- "T" Short-circuit / overload identified (signal telegram is cancelled if configured)

On next error detection in group 4-6: Test switch-on time: 10 s

Example 2

Error case = Weak overload at valve output 2.

The overload is so weak that a switch-on time of 1 second does not lead to error detection. In the case of a weak overload, it should be expected that the overload/short-circuit signal only affects the directly affected output group (here: Outputs 1 to 3). This produces the following sequence...

Test time	Outputs						KNX message						Comment
	1	2	3	4	5	6	1	2	3	4	5	6	
6min	0	0	0	N	N	N	-	-	-	-	-	-	Overload only affects one group!
1s	1	0	0	N	N	N	-	-	-	-	-	-	Check output 1 → No error
1s	0	1	0	N	N	N	-	-	-	-	-	-	Check output 2 4 s later → No error
1s	0	0	1	N	N	N	-	-	-	-	-	-	Check output 3 4 s later → No error
---	N	N	N	N	N	N	-	-	-	-	-	-	4 s later: All outputs working normally.

Figure 22: Weak overload at valve output 2 / first testing cycle

On next error detection in group 1...3: Test switch-on time: 10 s  
 It should be expected that, in normal operation, an overload will again be detected in the previously affected output group...

Test time	Outputs						KNX message						Comment
	1	2	3	4	5	6	1	2	3	4	5	6	
6min	0	0	0	N	N	N	-	-	-	-	-	-	Overload only affects one group!
10s	1	0	0	N	N	N	-	-	-	-	-	-	Check output 5 → No error
<10s	0	1	0	N	N	N	-	T	-	-	-	-	Check output 2 4 s later → Overload
6min	0	0	0	N	N	N	-	-	-	-	-	-	Switch-off idle phase. Overload message
10s	0	0	1	N	N	N	-	-	-	-	-	-	Check output 3 4 s later → No error
---	N	0	N	N	N	N	-	-	-	-	-	-	Output 2 remain deactivated 4 s later! All the other outputs continue to work "normally"!

Figure 23: Weak overload at valve output 2 / second testing cycle

On next error detection in group 1...3: Test switch-on time: 1 s

Example 3

Error = Total overload in output group "Output 1 to 3".

The overload of individual valve outputs is so weak that, during the testing cycles, no output can be clearly identified as overloaded or having shorted during a test switch-on time of 4 minutes. This produces the following sequence...

Test time	Outputs						KNX message						Comment
	1	2	3	4	5	6	1	2	3	4	5	6	
6min	0	0	0	N	N	N	-	-	-	-	-	-	Overload only affects one group!
1s	1	0	0	N	N	N	-	-	-	-	-	-	Check output 1 → No error
1s	0	1	0	N	N	N	-	-	-	-	-	-	Check output 2 4 s later → No error
1s	0	0	1	N	N	N	-	-	-	-	-	-	Check output 3 4 s later → No error
---	N	N	N	N	N	N	-	-	-	-	-	-	4 s later: All outputs working normally.

Figure 24: Total overload in output group 1...3 / first testing cycle

On next error detection in group 1...3: Test switch-on time: 10 s  
 It should be expected that, in normal operation, an overload will again be detected in the previously affected output group...

Test time	Outputs						KNX message						Comment
	1	2	3	4	5	6	1	2	3	4	5	6	
6min	0	0	0	N	N	N	-	-	-	-	-	-	Overload only affects one group!
10s	1	0	0	N	N	N	-	-	-	-	-	-	Check output 1 → No error
10s	0	1	0	N	N	N	-	-	-	-	-	-	Check output 2 4 s later → No error
10s	0	0	1	N	N	N	-	-	-	-	-	-	Check output 3 4 s later → No error
---	N	N	N	N	N	N	-	-	-	-	-	-	4 s later: All outputs working normally.

Figure 25: Total overload in output group 1...3 / second testing cycle

On next error detection in group 1...3: Test switch-on time: 1 min.  
It should be expected that, in normal operation, an overload will again be detected in the previously affected output group...

Test time	Outputs						KNX message						Comment
	1	2	3	4	5	6	1	2	3	4	5	6	
6min	0	0	0	N	N	N	-	-	-	-	-	-	Overload only affects one group!
1min	1	0	0	N	N	N	-	-	-	-	-	-	Check output 1 → No error
1min	0	1	0	N	N	N	-	-	-	-	-	-	Check output 2 4 s later → No error
1min	0	0	1	N	N	N	-	-	-	-	-	-	Check output 3 4 s later → No error
---	N	N	N	N	N	N	-	-	-	-	-	-	4 s later: All outputs working normally.

Figure 26: Total overload in output group 1...3 / third testing cycle

On next error detection in group 1...3: Test switch-on time: 4 min.  
It should be expected that, in normal operation, an overload will again be detected in the previously affected output group...

Test time	Outputs						KNX message						Comment
	1	2	3	4	5	6	1	2	3	4	5	6	
6min	0	0	0	N	N	N	-	-	-	-	-	-	Overload only affects one group!
4min	1	0	0	N	N	N	-	-	-	-	-	-	Check output 1 → No error
4min	0	1	0	N	N	N	-	-	-	-	-	-	Check output 2 4 s later → No error
4min	0	0	1	N	N	N	-	-	-	-	-	-	Check output 3 4 s later → No error
---	N	N	0	N	N	N	-	-	T	-	-	-	4 s later: Output 3 is deactivated autom. according to the priority. All the other outputs continue to work "normally"!

Figure 27: Total overload in output group 1...3 / fourth testing cycle

On next error detection in group 1-3: Test switch-on time: 1 s

### Short-circuit / overload signal telegrams

Signal telegrams, are only transmitted for the outputs which were deactivated by priority in the testing cycle, after the detection of an error or a collective overload. The precondition is that the signal telegram on the parameter page "Ax - Command value/Status/Operating mode" is enabled by the "Short-circuit / overload signal ?" parameter in the "Yes" setting. The telegram polarity of the signal telegram can be configured.

An active short-circuit / overload signal remains intact after a device reset by bus voltage return. In this case as well, the short-circuit / overload signal must first be reset (see "Resetting a short-circuit / overload" below). If, before the bus/mains voltage failure, no short-circuit and no overload was identified, then the actuator will first transmit a signal telegram "No short-circuit / no overload" after bus voltage return. Should, after bus/mains voltage return, a short-circuit or an overload occur, then the actuator will start a new identification phase.

After an ETS programming operation, short-circuit / overload signals are always deactivated. Here, in the case of shorted or overloaded valve outputs, the actuator will first perform an identification phase again, in order to detect faulty valve outputs.

- i** The object always transmits the current status after bus voltage return and an ETS programming operation after a delay, providing that a delay after bus voltage return has been configured on the "General" parameter page.
- i** The states "Short-circuit" and "Overload" are also fed back in the combined valve status (see page 104-105).

## Resetting a short-circuit / overload

Valve outputs, identified as having shorted or being overloaded, are detected by the actuator. In this case, affected valve outputs can no longer be activated by any functions of the actuator. The cause of the error must be eliminated and the "Short-circuit / overload" state also be reset, so that the outputs can be activated again.

There are two alternative options for the recommissioning of one or more deactivated valve outputs...

- Global reset of all overload / short-circuit states:  
All the overload / short-circuit states of the actuator can be reset jointly. For this, the 1-bit communication object "Reset short-circuit / overload" is available, which can be enabled on the parameter page "Valve / pump", using the "Global reset of all 'Short-circuit / overload' signals" parameter in the "Yes" setting. As soon as the actuator receives a "1" telegram via this object, all the overload / short-circuit states will be reset immediately. The actuator then deactivates the overload / short-circuit state of each valve output and also retracts the overload / short-circuit signals. Should all or some of the valve outputs still be shorted or overloaded at this time, then a new identification phase will begin.  
A "0" telegram to the "Reset short-circuit / overload" object produces no reaction.
- i** The global resetting of an overload or a short-circuit during a testing cycle is always ignored.
  
- Resetting by switching off the valve voltage supply:  
Overload / short-circuit states can be reset by switching off the valve voltage supply. The following procedure is required for this:
  - a) Switch-off of the valve voltage supply. After this, the actuator immediately sends a signal telegram "Failure of operating voltage", provided that this function is globally enabled in the ETS and the bus voltage is still switched on. In addition, all the overload / short-circuit signals of the valve outputs are reset immediately. If, at this time, no bus voltage is switched on, then the actuator will reset the overload / short-circuit signals after the bus voltage is switched on again.
  - b) Elimination of the cause of the overload / short-circuit
  - c) Switch-on of the valve voltage supply. The valves can then be activated again normally. When the valve voltage supply is switched on, the actuator also retracts the "Failure of operating voltage" signal, provided that this function is globally enabled in the ETS.
  - d) Should all or some of the valve outputs still be shorted or overloaded after the return of the valve voltage supply, then a new identification phase will begin.
- i** Switching off the valve voltage during a testing cycle only causes a reset of existing overload / short-circuit signals. The testing cycle is not cancelled.



## 4.2.4.2.10 Valve rinsing

To prevent calcification or sticking of a valve which has not been activated for some time, the actuator has an automatic valve rinsing function. Valve rinsing can be executed cyclically or using a bus command, causing the activated valves to run through the full valve stroke for a preset period of time. During valve rinsing, the actuator activates a command value of 100 % without interruption for the affected valve output for half of the configured "Valve rinsing time". For this, the valves open completely. After half the time, the actuator switches to a command value of 0%, causing the connected valves to close completely.

If necessary, the intelligent valve rinsing can be enabled. In so doing, cyclical rinsing using the full stroke is only executed when a defined minimum command value limiting value was not exceeded during actuator operation.

- i** During valve rinsing, the actuator executes the command values "1" (corresponds to "100 %" - open completely) and "0" (corresponds to "0 %" - close completely) for valve outputs configured with a command value limiting value for the data formats "Switching (1-bit)" or "Constant (1-byte)".
- i** The actuator takes the valve direction of action configured in the ETS into account in the electrical activation of the valve output.

At the end of valve rinsing, the actuator automatic sets the tracked command value according to the priority control (see page 54-55).

- i** The actuator does not execute valve rinsing if a higher-priority function is active. Nonetheless, the actuator internally starts the rinse length, as soon as the device receives a command for valve rinsing (cyclically or via bus command). If, during an active rinsing time, higher-priority functions are exited, then the actuator will execute the remaining residual time of the rinse function. If the rinsing time continuous to elapse during a function with a higher priority, then there is no residual time. Thus, the actuator will not execute the previously started valve rinsing.
- i** If the bus control of individual valve outputs is disabled as part of a permanent manual operation, then the actuator will save the start commands of a valve rinsing operation in the background. In this case, the actuator will start the rinse time immediately after the lifting of the disabling function. If, after this, the manual operation is exited after the rinse time has started (and no other higher-priority functions are active), then the actuator will also execute valve rinsing actively.
- i** The actuator also executes valve rinsing by starting the rinse time, even if the valve power supply has been switched off. A bus voltage failure immediately interrupts an active rinsing operation. When the bus/mains voltage returns, a previously interrupted rinsing operation is not executed again.
- i** Valve rinsing influences the status feedback of the active command value.

Valve rinsing possesses a separate 1-bit status object. Optionally, this object can be used, for example, to display a KNX visualisation that valve rinsing is taking place (rinse operation time running). The status telegram can be used, for example, to disable a KNX room temperature controller for the length of the valve rinsing. Particularly in the case of long rinsing times, the disabling of the room temperature controller, possibly in combination with the disabling of the controller operation, can make a positive contribution to the suppression of the oscillation behaviour of the controller.

The telegram polarity of the status object is fixed: "0" = Valve rinsing inactive, "1" = Valve rinsing active.

- i** The object transmits the current status after bus and mains voltage return and after an ETS programming operation without a delay.

### Enabling valve rinsing

Valve rinsing can only be used if it has been enabled in the ETS.

- Set the "Use 'Valve rinsing' function ?" parameter on the parameter page "Ax - Valve rinsing" to "Yes". In the "Valve rinsing time" parameter, configure for how long the rinse function (100 % -> 0 %) is to be executed.  
Valve rinsing is enabled. Additional parameters become visible in the ETS, presetting whether the valve rinsing is to be activated cyclically and / or with bus control.
- ❗ Set the length of the valve rinsing to the adjustment cycle time of the electrothermal actuators in such a way that they open and close completely. This is usually guaranteed by configuring the rinsing length to double the adjustment cycle time.
- Set the "Use 'Valve rinsing' function ?" parameter to "no".  
Valve rinsing is not available.

### Configuring cyclical valve rinsing

The actuator can perform valve rinsing cyclically, if necessary. When using the cyclical valve rinsing, a rinse operation can be started automatically after a configurable cycle time (1...26 weeks). Here too, the valve rinsing length configured in the ETS defines the time for the once-only, complete opening and closing of the activated valve drives. At the end of a rinsing operation, the actuator always restarts the cycle time.

Valve rinsing must be enabled and a valid rinsing time configured.

- Set the "Activate cyclical valve rinsing ?" parameter to "yes". In the case of the "Cycle time" parameter, configure how often valve rinsing is to be performed automatically.  
Cyclical valve rinsing is enabled.
- Set the "Activate cyclical valve rinsing ?" parameter to "no".  
Cyclical valve rinsing is completely disabled. Valve rinsing can only be started by the communication object (if enabled).
- ❗ Each ETS programming operation resets the cycle time. The first rinsing operation with cyclical valve rinsing takes place after an ETS programming operation after the first time cycle has elapsed.  
If there is a bus voltage failure, the actuator saves the remaining residual time of the current time cycle. The residual cycle time is restarted after bus voltage return.  
A bus voltage failure immediately interrupts an active rinsing operation. When the bus/mains voltage returns, a previously interrupted rinsing operation is not executed again. The actuator then starts a new time cycle for cyclical valve rinsing.

Optionally, intelligent cyclical valve rinsing can be additionally activated. Here, valve rinsing is only executed repeatedly, if, in the current time cycle, a minimum command value limiting value, configurable in the ETS, was not exceeded. If the active command value exceeds the limiting value, then the actuator will stop the cycle time. The actuator only restarts the cycle time if, in the further course of the command value change, a command value of "0 %" or "OFF" (completely closed) is set (Figure 28). This prevents valve rinsing if the valve has already run through a sufficiently defined stroke.

If, after exceeding the configured limiting value, the value was not completely closed at least once (command value "0 %" or "OFF"), then no further cyclical valve rinsing will take place.

Use of the intelligent cyclical valve rinsing means that rinsing operations over the entire valve stroke are only then used when this is sensible and actually required. For example, in the summer months, the use of heating power is lower. In consequence, the valves are activated less frequently by command values, meaning that valve rinsing should be performed as anti-sticking protection. In the winter months, it is frequent necessary to activate heating valves using normal command value telegrams.

The intelligent valve rinsing ensures that no redundant valve rinsing is not performed in the winter. In the summer, the intelligent control performs valve rinsing cyclically.

- ❗ The cycle time is always started after an ETS programming operation. This also occurs when the active command value exceeds the configured limiting value after the download.

- i** The combination of intelligent valve rinsing with a command value limit with a minimum command value limiting value. If a minimum limiting value of the command value limit exists, then the active command value of the affected cycle valve output is never "0 %". In consequence, the actuator would never restart the cycle time as part of intelligent valve rinsing.

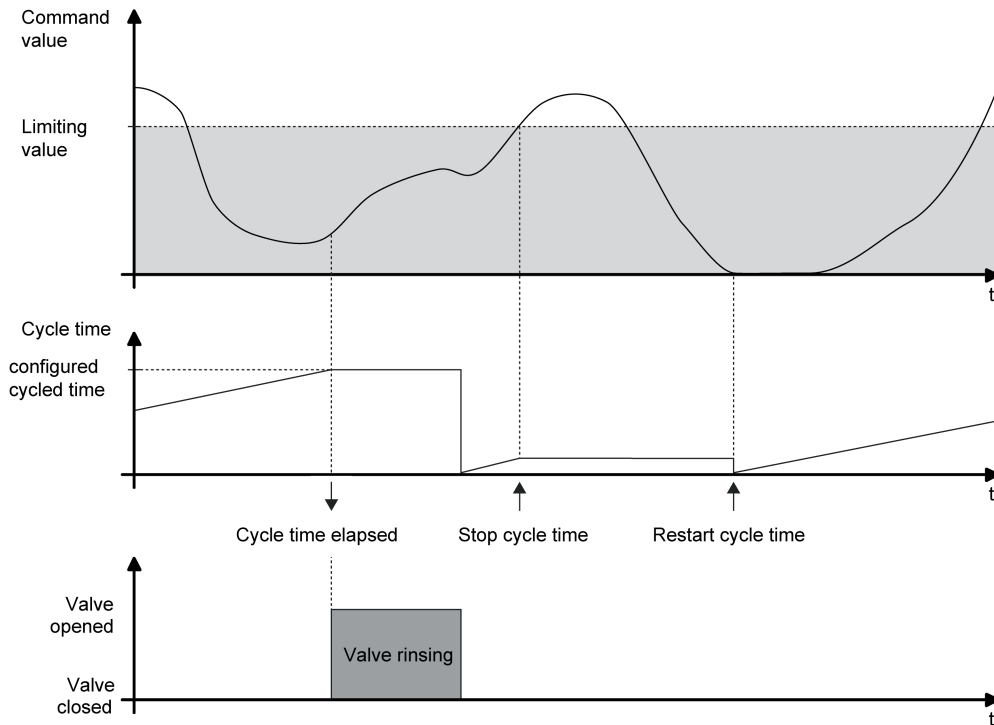

Figure 28: Example of a minimum command value limiting value for intelligent valve rinsing

- Set the "Use intelligent valve rinsing ?" parameter to "yes". Using the "Limiting value minimum command value (10...100 %)" parameter, define the command value limiting value.

Intelligent cyclical valve rinsing is activated. Valve rinsing is only executed when the configured limiting value was exceeded at least once in the previous time cycle and, consequently, the valve was run to the "0 %" command value.

- Set the "Use intelligent valve rinsing ?" parameter to "no". Intelligent cyclical valve rinsing is deactivated. Valve rinsing always takes place as soon as the set cycle time has expired.

- i** Valve rinsing can optionally be started and, if required, stopped using a communication object. If valve rinsing was started by the object, then the actuator will stop the cycle time of the cyclical valve rinsing operation. The cycle time is only restarted after the rinsing operation has been fully executed without interruption or a stop command was received via the object.

### Configuring bus-controlled valve rinsing via an object

If necessary, valve rinsing can be started and, optionally, stopped using its own 1-bit communication object. This means that it is possible to activate a rinsing operation of the valve controlled by time or an event. It is also possible, for example, to cascade multiple heating actuators, so that they perform valve rinsing simultaneously (link of the individual status objects to the input objects of the valve rinsing).

Bus control can only be used if it has been enabled in the ETS.

Valve rinsing must be enabled and a valid rinsing time configured.

- Set the "Valve rinsing activated externally ?" parameter to "yes". In the case of the parameter "Polarity of 'Start / stop valve rinsing' object", configure the telegram polarity, thus presetting whether the bus-controlled starting and stopping, or, alternatively, only starting, should be possible.

Bus-controlled valve rinsing is enabled. The communication object is visible. The name of the object is aligned to the setting of the permitted telegram polarity ("Start / stop valve rinsing" or "Start valve rinsing"). When a start command is received, the actuator immediately starts the configured time for a rinsing operation. The actuator also actively executes valve rinsing if no higher-priority function is active. If bus-controlled stopping is permitted, then the actuator will also react to stop commands by immediately interrupting running rinsing operations.

- Set the "Valve rinsing activated externally ?" parameter to "no".

Bus-controlled valve rinsing is not available. Valve rinsing can only take place cyclically.

- i** Updates of the object from "Start" to "Start" or "Stop" to "Stop" do not produce a reaction. The length of an elapsing valve rinsing operation or the cycle time of a cyclical valve rinsing operation are not restarted by this.
- i** Bus-controlled valve rinsing via the object can be combined with a cyclical valve rinsing operation. If valve rinsing was started by the object, then the actuator will stop the cycle time of the cyclical valve rinsing operation. The cycle time is only restarted after the rinsing operation has been fully executed without interruption or a stop command was received via the object.

## 4.2.4.2.11 Operating hours counter

The operating hours counter determines the switch-on time of a valve output. For the operating hours counter, an output is actively on, when it is energised, i.e. when the status LED on the front panel of the device. As a result, the operating hours counter determines the time during which deenergised closed valves are opened or deenergised opened valves are closed. The operating hours counter adds up the determined switch-on time accurately to the minute for energised valve outputs in full hours respectively (Figure 29). The totalled operating hours are added in a 2-byte counter and stored permanently in the device. The current counter status can be transmitted cyclically to the bus by the "value operating hours counter" communication object or when there is a change in an interval value.

- i** During pulse width modulation (PWM) at a valve output, the operating hours counter only evaluates the switch-on time of the PWM signal.

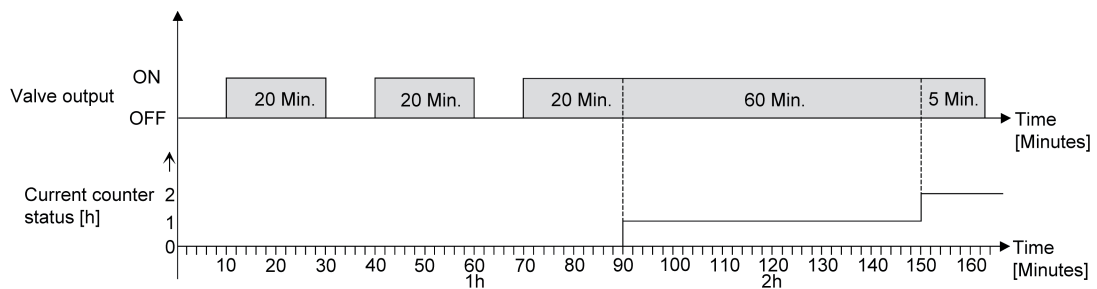

Figure 29: Function of the operating hours counter (using the example of an up-counter)

In the as-delivered state, the operating hour values of all valve outputs of the actuator is "0". If the operating hours counter is not enabled in the configuration of an output, no operating hours will be counted for the valve concerned. Once the operating hours counter is enabled, however, the operating hours will be determined and added up by the ETS immediately after commissioning the actuator.

If the operating hours counter is subsequently disabled again in the parameters and the actuator is programmed with this disabling function, all the operating hours previously counted for the valve output concerned will be deleted. When enabled again, the counter status of the operating hours counter is always on "0".

The operating hours values (full hours) stored in the device will not be lost in case of a bus and mains voltage failure or by an ETS programming operation. Any summed up operating minutes (full hour not yet reached) will be rejected in this case, however.

After bus voltage return or after an ETS download, the actuator passively updates the "Value operating hours counter" communication object in each valve output. The object value can be read out if the read-flag is set. The object value, depending on the configuration for the automatic transmission, is actively transmitted if necessary to the bus, once the configured transmission delay has elapsed after bus voltage return.

The operating hours counter detects any operation of the valve outputs by the manual operation, which means that switching on an output also activates the counting of operating hours and the manual switch-off interrupts a counting operation.

No operating hours are counted if the supply voltage of the valves is not switched on.

- i** If only the mains voltage supply of the actuator and the valve voltage are switched on (bus voltage switched off / construction site mode), summed-up operating hours will not be stored in the event of a mains voltage failure!

### Activating the operating hours counter

The operating hours counter only counts the operating hours of a valve output if it was activated in the ETS.

- On the parameter page "Ax - Operating hours counter", set the "Use operating hours counter ?" parameter to "yes".  
The operating hours counter is activated.
  - On the parameter page "Ax - Operating hours counter", set the "Use operating hours counter ?" parameter to "no".  
The operating hours counter is deactivated.
- i** Deactivation of the operating hours counter and subsequent programming with the ETS resets the counter status to "0".

## Setting type of counter of the operating hours counter

The operating hours counter can optionally be configured as an up-counter or down-counter. Depending on this type of counter, a limit or start value can be set optionally, whereby, for example, the operating time of an actuator can be monitored by restricting the counter range.

Up-counter:

After activating the operating hours counter by enabling in the ETS or by restarting, the operating hours are counted starting at "0". A maximum of 65535 hours can be counted, after that the counter stops and signals a counter operation via the "Operating hours count. elapsed" object.

A limiting value can be set optionally in the ETS or can be predefined via the communication object "Limiting value operating hours counter". In this case, the counter operation is signalled to the bus via the "Operating hours count. elapsed" object if the limiting value is reached, but the counter continues counting - if it is not restarted - up to the maximum value 65535 and then stops. Only a restart initiates a new counting operation.

Down-counter:

After enabling the operating hours counter in the ETS, the counter status is on "0" and the actuator signals a counter operation for the valve output concerned after the programming operation or after bus voltage return via the "Operating hours count. elapsed" object. Only after a restart is the down-counter set to the maximum value 65535 the counting operation started. A start value can be set optionally in the ETS or can be predefined via the communication object "start value operating hours counter". If a start value is set, the down-counter is initialised with this value instead of the maximum value after a restart. The counter then counts the start value downwards by the hour. When the down-counter reaches the value "0", the counter operation is signalled to the bus via the "Operating hours count. elapsed" and the counting is stopped. Only a restart initiates a new counting operation.

The use of the operating hours counter must be set on the parameter page "Ax – Operating hours counter".

- Set the parameter "Counter type" to "Up-counter". Set the parameter "Limiting value specification?" to "yes, as parameter" or "yes, as received via object" if it is necessary to monitor the limiting value. Otherwise, reset the parameter to "no". In the "yes, as specified in parameter" setting, specify the required limit value (1...65535 h).

The counter counts the operating hours forwards starting from "0". If the monitoring of the limiting value is activated, the actuator transmits a "1" telegram via the object "Operating hours count. elapsed" for the valve output concerned once the predefined limiting value is reached. Otherwise, the counter operation is first transmitted when the maximum value 65535 is reached.

- Set the parameter "Counter type" to "Down-counter". Set the parameter "start value preset ?" to "yes, as parameter" or "yes, as received via object" if a start value preset is necessary. Otherwise, reset the parameter to "no". In the "yes, as specified in parameter" setting, specify the required start value (1...65535 h).

The counter counts the operating hours down to "0" after a restart. With a start value preset, the start value is counted down, otherwise the counting operation starts at the maximum value 65535. The actuator transmits a "1" telegram via the object "Operating hours count. elapsed" for the valve output concerned once the value "0" is reached.

- i** The value of the communication object "Operating hours count. elapsed" is stored permanently. The object is initialised immediately with the value that was saved before bus voltage return or ETS programming. If an operating hours counter is in this case identified as having elapsed, i.e. if the object value is a "1", an additional telegram will be actively transmitted to the bus. If the counter has not yet elapsed (object value "0"), no telegram is transmitted on return of bus/mains voltage or after an ETS programming operation.
- i** With a limiting or start value preset via object: The values received via the object are first validly accepted and permanently saved internally after a restart of the operating hours counter. The object is initialised immediately with the value that was last saved before bus voltage return or ETS programming. The values received will be lost in the case of a bus voltage failure or by an ETS download if no counter restart was executed before. For this reason, when specifying a new start or limiting value it is advisable to always execute a counter restart afterwards as well.  
A standard value of 65535 is predefined provided that no limiting value or start value has been received yet via the object. The values received and stored via the object are reset to the standard value if the operating hours counter is disabled in the parameters of the ETS and a ETS download is being performed.
- i** With a limiting or start value predefined via object: If the start or limiting value is predefined with "0", the actuator will ignore a counter restart to avoid an undesired reset (e.g. in site operation -> hours already counted by manual operation).
- i** If the counter direction of an operating hours counter is reversed by reconfiguration in the ETS, a restart of the counter should always be performed after programming the actuator so that the counter is reinitialised.

## Restarting the operating hours counter

The current counter status of the operating hours can be reset at any time by the communication object "Reset operating hours counter". The polarity of the reset telegram is predefined: "1" = Restart / "0" = No reaction.

- Characterise the communication object "Reset operating hours counter" with "1".  
In the up-counter the counter is initialised with the value "0" after a restart and in the down-counter initialised with the start value. If no start value was configured or predefined by the object, the start value is preset to 65535.  
During every counter restart, the initialised counter status is transmitted actively to the bus. After a restart, the signal of a counter operation is also reset. At the same time, a "0" telegram is transmitted to the bus via the object "Operating hours count. elapsed".  
In addition, the limiting or start value is initialised.
- i** If a new limiting or start value was predefined via the communication object, a counter restart should always be performed afterwards, too. Otherwise, the values received will be lost in the case of a bus voltage failure or by an ETS download.
- i** If a start or limiting value is predefined with "0", there are different behaviours after a restart, depending on the principle of the value definition...  
Preset as parameter:  
The counter elapses immediately after a counter restart.  
Preset via object:  
A counter restart will be ignored to avoid an undesired reset (e.g. after installation of the devices with hours already being counted by manual operation). A limiting or start value greater than "0" must be predefined in order to perform the restart.

## Transmission behaviour of the operating hours counter

The current value of the operating hours counter is always tracked in the communication object "value operating hours counter". After bus voltage return or after an ETS download, the actuator passively updates the "Value operating hours counter" communication object in each valve

output. The object value can be read out if the read-flag is set.

In addition, the transmission behaviour of this communication object can be set.

The use of the operating hours counter must be set on the parameter page "Ax – Operating hours counter".

- Set the parameter "Automatic transmission of numeric value" on parameter page "Ax - Operating hours counter" to "After change by interval value". Set the "Counting value interval (1...65535 h)" to the desired value.

The counter status is transmitted to the bus as soon as it changes by the predefined counting value interval. After bus and mains voltage return or after programming in the ETS, the object value is transmitted automatically and immediately if the current counter status or a multiple of this corresponds to the counting value interval. A counter status "0" is always transmitted in this case.

The object value is not transmitted if there is solely bus voltage return (mains voltage supply of the actuator available without interruption).

- Set the parameter "Automatic transmission of counting value" to "Cyclical".

The counter value is transmitted cyclically. The cycle time is defined on the parameter page "General". After bus and mains voltage return or an ETS programming operation, the counter status is transmitted to the bus after the configured cycle time has elapsed.



### 4.2.4.3 Channel-orientated functional description for controllers

Six controllers are integrated in the device software, which can be used for single-room temperature control. This allows the temperature to be set in up to 6 rooms or room areas to specified setpoints through independent control processes. The command value outputs of these controllers can be internally linked to the electronic valve outputs of the actuator, meaning that temperature control and valve activation can take place using just one bus device, if required. The use of external room temperature controllers (e.g. push-button sensors with RTC) is thus not absolutely essential, but is possible as the valve outputs can also be activated individually via the KNX. The integrated controllers can also transmit command value telegrams to the KNX and thus activate other heating actuators or fan coil actuators.

The integrated controllers of the device always work as the main controller. All the controller functions (e.g. setpoint temperature specification, operating mode switchover, switchover of the operating mode) are controlled via KNX communication objects (object controller without its own operating elements), meaning that controller operation is possible via controller extensions or visualisations. The room temperature is made available to the integrated controllers via separate communication objects.

#### 4.2.4.3.1 Operating modes and operating mode change-over

##### Introduction

A room temperature controller distinguishes between two different operating modes. The operating modes specify whether you want the controller to use its variable to trigger heating systems ("heating" single operating mode) or cooling systems ("cooling" single operating mode). You can also activate mixed operation, with the controller being capable of changing over between "Heating" and "Cooling" either automatically or, alternatively, controlled by a communication object.

In addition, you can establish two-level control operation to control an additional heating or cooling unit. For two-level feedback control, separate command values will be calculated as a function of the temperature deviation between the setpoint and the actual value for the basic and additional levels. The parameter "Operating mode" in the "Room temperature control -> RTCx - General" parameter branch specifies the operating mode and, if necessary, enables the additional level(s).

##### "Heating" or "cooling" single operating modes

In the single "Heating" or "Cooling" operating modes without any additional level, the controller will always work with one command value. Alternatively, when the additional level is enabled, it will use two command values in the configured operating mode. Depending on the room temperature determined and on the specified setpoint temperatures of the operating modes, the room temperature controller will automatically decide whether heating or cooling energy is required and calculates the command value for the heating or cooling system.

## "Heating and cooling" mixed operating mode

In the "Heating and cooling" mixed operating mode, the controller is capable of triggering heating and cooling systems. In this connection, you can set the change-over behaviour of the operating modes...

- "Switchover between heating and cooling" parameter in the "Room temperature control -> RTCx - General" parameter branch set to "Automatic".  
In this case, a heating or cooling mode is automatically activated, depending on the determined room temperature and on the specified setpoint temperature. If the room temperature is within the preset deadband neither heating nor cooling will take place (both command values = "0"). The communication object "Setpoint temperature" displays the most recently active setpoint temperature for heating or cooling. If the room temperature is higher than the cooling setpoint temperature, cooling will take place. If the room temperature is higher than the heating setpoint temperature, heating will take place. When the operating mode is changed over automatically, the information can be actively sent to the bus via the object "Heating/cooling switchover" to indicate whether the controller is working in the heating mode ("1" telegram) or in the cooling mode ("0" telegram). In this case, a telegram will be transmitted immediately on changing from heating to cooling (object value = "0") or from cooling to heating (object value = "1"), respectively. The "Cyclical transmission heating/cooling change-over" parameter enables cyclic transmission (factor > "0" setting) and specifies the cycle time.  
With an automatic operating mode change-over, it should be noted that under certain circumstances there will be continuous change-over between heating and cooling if the deadband is too small. For this reason, you should, if possible, not set the deadband (temperature difference between the setpoint temperatures for the comfort heating and cooling modes) below the default value (2 K).
  
- "Switchover between heating and cooling" parameter in the "Room temperature control -> RTCx - General" parameter branch set to "Via object".  
In this case, the operating mode is controlled via the "Heating/cooling switchover" object, irrespective of the deadband. This type of change-over can, for example, become necessary if both heating and cooling should be carried out through a one-pipe system (heating and cooling system). For this, the temperature of the medium in the single-pipe system must be changed via the system control. Afterwards the heating/cooling operating mode is set via the object (often the single-pipe system uses cold water for cooling during the summer, hot water for heating during the winter).  
The "Heating/cooling switchover" object has the following polarities: "1": Heating; "0": Cooling. After a reset, the object value will be "0", and the "Heating/cooling operating mode change-over after reset" set in the ETS will be activated. You can use the "Heating/cooling operating mode after reset" parameter to set which mode you want to activate after a reset. For the "Heating" or "Cooling" settings, the controller will activate the configured heating/cooling operating mode immediately after the initialisation phase. In case of parameterisation "Operating mode before reset" the operating mode which was selected before the reset will be activated.

- i** Setpoint temperatures can be specified for each operating mode in the ETS as part of configuration. It is possible to configure the setpoints for the "Comfort", "Standby" and "Night" modes directly (absolute setpoint presetting) or relatively (derivation from basic setpoint). With absolute setpoint presetting there is no basic setpoint and also no deadband in the mixed operating mode "Heating and cooling" (if necessary also with additional level). Consequently, the room temperature controller cannot control the switchover of the operating mode automatically, which is why, in this configuration, the setting for the parameter "Switchover between heating and cooling" is fixed in the ETS to "Via object".

- i** It is not possible to heat and cool at the same time (both command values for heating and cooling > "0"). With pulse width-modulated command value output (PWM), the command values are only adjusted by the controller at the end of a PWM cycle. The controller always recalculates and updates signal telegrams (1-bit) for "heating" and "cooling" cyclically every 30 seconds. The different update intervals for the PWM command values and the signal telegrams mean that there may be a brief overlap of the request for heating or cooling energy by the command values and by the signal telegrams at the transition between heating and cooling. This overlapping is corrected automatically at the end of a PWM cycle by adjusting the command values.

## Heating/cooling message

Depending on the set operating mode, separate objects can be used to indicate whether the controller is currently demanding heating or cooling energy and is thus actively heating or cooling. As long as the heating command value is > "0", a "1" telegram will be transmitted through the "Heating" signal object. The signal telegram is only reset when the command value is "0" ("0" telegram is transmitted). The same applies to the signal object for cooling.

The signal objects can be enabled by the "Heating message" or "Cooling message" parameters in the "Room temperature control -> RTCx - General -> RTCx - Command value and status output" parameter branch. The control algorithm controls the signal objects. Please note that the command values are recalculated every 30 s, thus updating the signal objects.

- i** With pulse width-modulated command value output (PWM), the command values are only adjusted by the controller at the end of a PWM cycle. The different update intervals for the PWM command values and the signal telegrams mean that there may be a brief overlap of the request for heating or cooling energy by the command values and by the signal telegrams at the transition between heating and cooling. This overlapping is corrected automatically at the end of a PWM cycle by adjusting the command values.
- i** It should be noted that, with a 2-point feedback control, the signal objects for heating and cooling will already become active as soon as the temperature falls short of the temperature setpoint of the active operating mode in case of heating or exceeds the temperature setpoint in case of cooling. In this case, the configured hysteresis is not taken into account.
- i** The optional floor temperature limit does not influence the "Heating" message telegram. If the floor temperature exceeds the set limiting value, only the command value is switched off. In this case, the "Heating" message remains active.

#### 4.2.4.3.2 Control algorithms and calculation of command values

##### Introduction

To facilitate convenient temperature control in living or business spaces a specific control algorithm which controls the installed heating or cooling systems is required. Taking account of the preset temperature setpoints and the actual room temperature, the controller thus determines command values which trigger the heating or the cooling system. The control system (control circuit) consists of a room temperature controller, a valve actuator or an actuator with switching output signals (e.g. heating actuator when ETD electrothermal drives are used), the actual heating or cooling element (e.g. radiator or cooling ceiling) and of the room. This results in a controlled system (Figure 30).

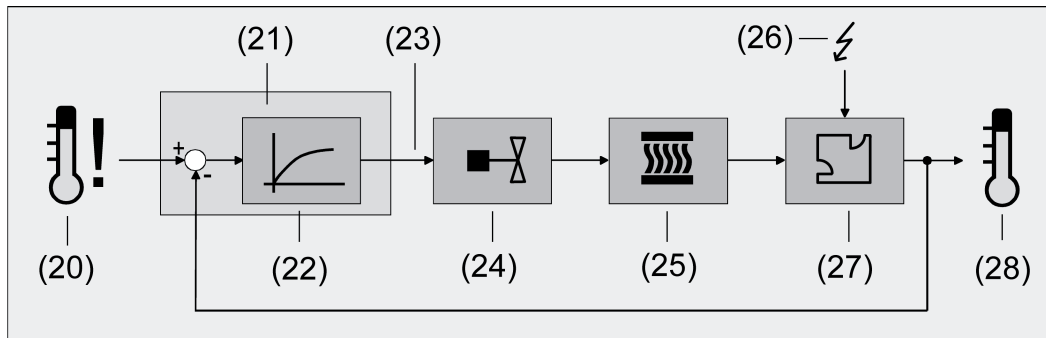

Figure 30: Controlled system of single-room temperature control

- (20) Setpoint temperature specification
- (21) Room temperature controller
- (22) Control algorithm
- (23) Command value
- (24) Valve control (actuating drive, ETD, heating actuator, ...)
- (25) Heat / cold exchanger (radiator, cooling ceiling, FanCoil, ...)
- (26) Fault variable (sunlight penetration, outdoor temperature, illumination systems, ...)
- (27) Room
- (28) Actual temperature (room temperature)

The controller evaluates the actual temperature (28) and compares it with the specified setpoint temperature (20). With the aid of the selected control algorithm (22), the command value (23) is then calculated from the difference between the actual and the setpoint temperature. The command value controls valves or fans for heating or cooling systems (24), meaning that heating or cooling energy in the heat or cold exchangers (25) is passed into the room (27). Regular readjustment of the command value means that the controller is able to compensate for setpoint / actual temperature differences caused by external influences (26) in the control circuit. In addition, the flow temperature of the heating or cooling circuit influences the control system which necessitates adaptations of the variable.

The room temperature controller facilitates either proportional/integral (PI) feedback control as a continuously working or switching option, or, alternatively, switching 2-point feedback control. In some practical cases, it can become necessary to use more than one control algorithm. For example, in bigger systems using floor heating, one control circuit which solely triggers the floor heating can be used to keep the latter at a constant temperature. The radiators on the wall, and possibly even in a side area of the room, will be controlled separately by an additional level with its own control algorithm. In such cases, distinction must be made between the different types of control, as floor heating systems, in most cases, require control parameters which are different to those of radiators on the wall, for example. It is possible to configure up to four independent control algorithms in two-level heating and cooling operation.

The command values calculated by the control algorithm are output via the "Heating command value" or "Cooling command value" communication objects. Depending on the control algorithm selected for the heating and/or cooling mode, the format of the command value objects is, among other things, also specified. In this way, 1-bit or 1-byte actuating objects can be created. The control algorithm is specified by the parameters "Type of heating control" or "Type of cooling control" in the "Room temperature control -> RTCx - General" parameter branch and, if necessary, also with a distinction of the basic and additional stages.

### Continuous PI control

PI control is an algorithm which consists of a proportional part and an integral part. Through the combination of these control properties, you can obtain room temperature control as quickly and precisely as possible without or only with low deviations.

When you use this algorithm, the room temperature controller will calculate a new continuous command value in cycles of 30 seconds and send it to the bus via a 1-byte value object, if the calculated command value has changed by a specified percentage. You can use the "Automatic transmission on change by..." parameter in the "Room temperature control -> RTCx - General -> RTCx - Command value and status output" parameter branch to set the change interval in percent.

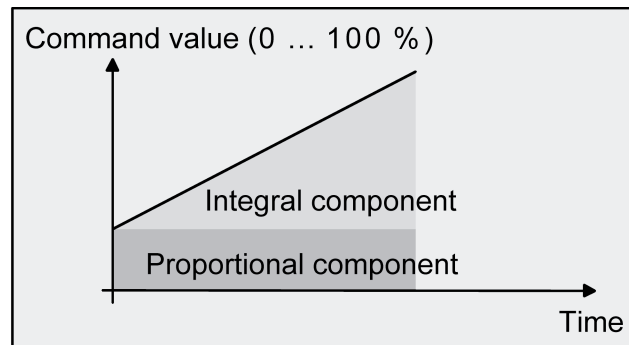

Figure 31: Continuous PI control

An additional heating or cooling level as PI control works in the same way as the PI control of the basic level, with the exception that the setpoint will shift, taking account of the configured level width.

### Switching PI control

With this type of feedback control, the room temperature will also be kept constant by the PI control algorithm. Taking the mean value for a given time, the same behaviour of the control system will result as you would obtain with a continuous controller. The difference compared with continuous feedback control is only the way how the command value is output. The command value calculated by the algorithm in cycles of every 30 seconds is internally converted into a pulse width-modulated (PWM) command value signal and sent to the bus via a 1-bit switching object after the cycle time has elapsed. The mean value of the command value signal resulting from this modulation is a measure for the averaged position of the control valve, thus being a reference to the room temperature set, taking account of the cycle time which you can set through the "Cycle time of the switching command value..." parameter in the "Room temperature control -> RTCx - General -> RTCx - Command value and status output" parameter branch.

A shift of the mean value, and thus a change in the heating capacity, can be obtained by changing the duty factor of the switch-on and switch-off pulses of the command value signal. The duty factor will be adapted by the regulator only at the end of a time period, depending on the variable calculated. This applies to any change of the command value, regardless of what

the ratio is by which the command value changes (the "Automatic transmission on change by..." and "Cycle time for automatic transmission..." parameters will have no function in this case). Each command value calculated last during an active time period will be converted. Even after you have changed the setpoint temperature, for example, by switching over the operating mode, the command value will still be adapted after the end of an active cycle time. The diagram below shows the output command value switching signal according to the internally calculated command value (first of all, a command value of 30 %, then of 50 %, with the command value output not being inverted).

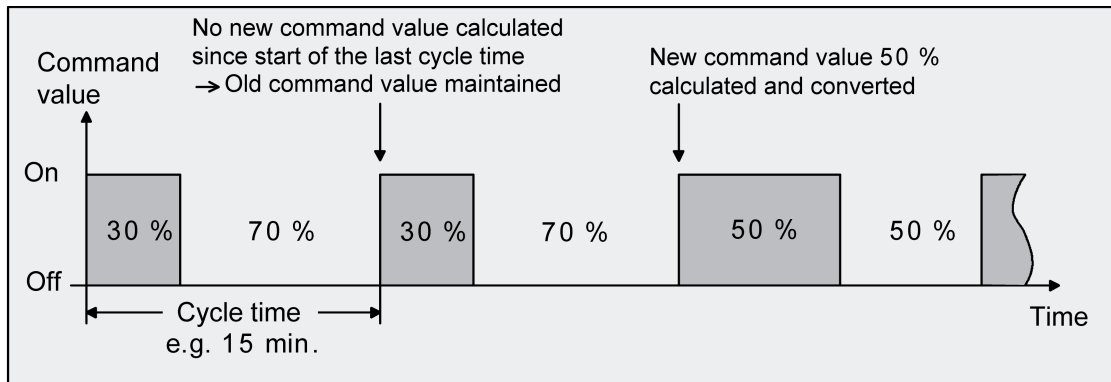

Figure 32: Switching PI control

For a command value of 0 % (permanently off) or of 100 % (permanently on), a command value telegram corresponding to the command value ("0" or "1") will always be sent after a cycle time has elapsed.

For switching PI control, the controller will always use continuous command values for internal calculation. Such continuous values can additionally be sent to the bus via a separate 1-byte value object, for example, as status information for visualisation purposes (if necessary, also separately for the additional levels). The status value objects will be updated at the same time as the command value is output and will only take place after the configured cycle time has elapsed. The parameters "automatic transmission on change by..." and "Cycle time for automatic transmission..." parameters will have no function in this case. An additional heating or cooling level as switching PI control works in the same way as the PI control of the basic stage, with the exception that the setpoint will shift, taking account of the configured level width. All PWM control options will use the same cycle time.

### Cycle time:

The pulse-width-modulated command values are mainly used for activating electrothermal drives (ETD). In this regard, the room temperature controller sends the switching command value telegrams to an actuator equipped with semiconductor switching elements to which the drives are connected (e.g. heating actuator). By setting the cycle time of the PWM signal on the controller, you can adapt the feedback control to the drives used. The cycle time sets the switching frequency of the PWM signal and allows adaptation to the adjusting cycle times of the actuators used (the adjusting time it takes the drive to bring the valve from its completely closed to its completely opened position). In addition to the adjusting cycle time, take account of the dead time (the time in which the actuators do not show any response when being switched on or off). If different actuators with different adjusting cycle times are used, take account of the longest of the times. Always note the information given by the manufacturers of the actuators. During cycle time configuration, a distinction can always be made between two cases...

Case 1: Cycle time > 2 x adjusting cycle time of the electrothermal drives used (ETD)

In this case, the switch-on or switch-off times of the PWM signal are long enough for the actuators to have sufficient time to fully open or fully close within a given time period.

Advantages:

The desired mean value for the command value and thus for the required room temperature will be set relatively precisely, even for several actuators triggered at the same time.

Disadvantages:

It should be noted, that, due to the full valve lift to be continuously 'swept', the life expectancy of the actuators can diminish. For very long cycle times (> 15 minutes) with less sluggishness in the system, the heat emission into the room, for example, in the vicinity of the radiators, can possibly be non-uniform and be found disturbing.

- i** This setting is recommended for sluggish heating systems (such as underfloor heating).
- i** Even for a bigger number of triggered actuators, maybe of different types, this setting can be recommended to be able to obtain a better mean value of the adjusting travels of the valves.

Case 2: Cycle time < adjusting cycle time of the electrothermal drives used (ETD)

In this case, the switch-on or switch-off times of the PWM signal are too short for the actuators to have enough time to fully open or fully close within a given period.

Advantages:

This setting ensures continuous water flow through the radiators, thus facilitating uniform heat emission into the room.

If only one actuator is triggered the regulator can continuously adapt the variable to compensate the mean value shift caused by the short cycle time, thus setting the desired room temperature.

Disadvantages:

If more than one drive is triggered at the same time the desired mean value will become the command value, which will result in a very poor adjustment of the required room temperature, or in adjustment of the latter with major deviations, respectively.

The continuous flow of water through the valve, and thus the continuous heating of the drives causes changes to the dead times of the drives during the opening and closing phase. The short cycle time and the dead times means that the required variable (mean value) is only set with a possibly large deviation. For the room temperature to be regulated constantly after a set time, the controller must continually adjust the command value to compensate for the mean value shift caused by the short cycle time. Usually, the control algorithm implemented in the controller (PI control) ensures that control deviations are compensated.

- i** This setting is recommended for quick-reaction heating systems (such as surface radiators).

## 2-point feedback control

2-point feedback control represents a very simple temperature control. For this type of feedback control, two hysteresis temperature values are set. The actuators are triggered by the controller via switch-on and switch-off command value commands (1-bit type). A continuous variable is not calculated for this type of control.

The room temperature is also evaluated by this type of control in cycles every 30 seconds. Thus the command values change, if required, only at these times. The disadvantage of a continuously varying temperature as a result of this feedback control option is in contrast with the advantage of this very simple 2-point room temperature control. For this reason, quick-reaction heating or cooling systems should not be triggered by a 2-point feedback control system, for this can lead to very high overshooting of the temperature, thus resulting in loss of comfort. When presetting the hysteresis limiting values, you should distinguish between the operating modes.

"Heating" or "cooling" single operating modes:

In heating mode, the controller will turn on the heating when the room temperature has fallen below a preset limit. In heating mode, the feedback control will only turn off the heating once a preset temperature limit has been exceeded.

In cooling mode, the controller will turn on the cooling system when the room temperature has exceeded a preset limit. The control system will only turn off the cooling system once the temperature has fallen below a preset limit. In this connection, variable "1" or "0" will be output, depending on the switching status, if the temperature exceeds or falls below the hysteresis limits.

The hysteresis limits of both operating modes can be configured in the ETS.

- i** It has to be pointed out that the message objects for heating and cooling already become active as soon as the temperature falls short of the temperature setpoint of the active operating mode in case of heating or exceeds the temperature setpoint in case of cooling. In this case the hysteresis is not being considered.

The following two images each show a 2-point feedback control for the individual operating modes "Heating" (Figure 33) or "Cooling" (Figure 34). The images take two temperature setpoints, one-stage heating or cooling and non-inverted command value output into account.

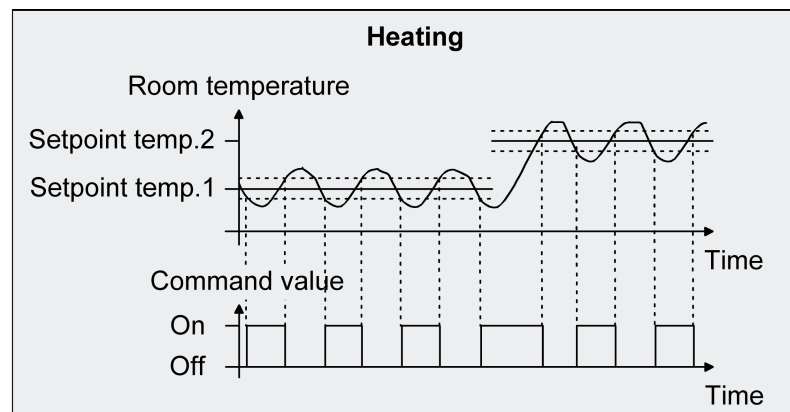

Figure 33: 2-point feedback control for the single "Heating" operating mode



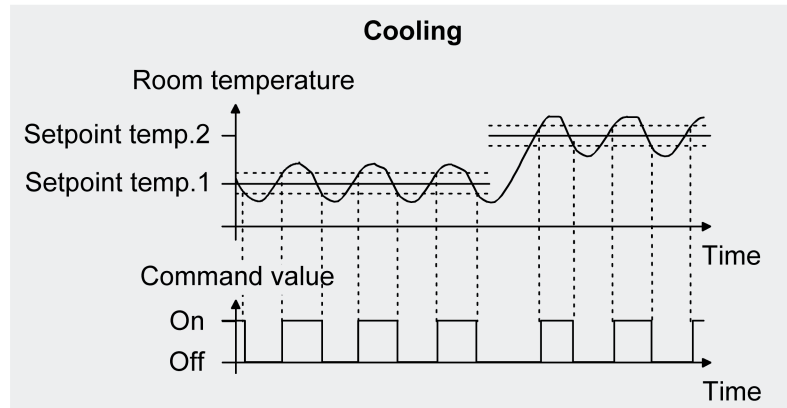

Figure 34: 2-point feedback control for the single "Cooling" operating mode

An additional 2-point feedback control heating or cooling level works exactly the same as the 2-point feedback control of the basic level. The difference is that the setpoint and the hysteresis values will shift by taking into account the configured level offset.

"Heating and cooling" mixed operating mode:

In mixed operation, a distinction is made whether the change-over between heating and cooling is to be effected automatically or in a controlled way through the object...

- With automatic operating mode change-over, in the heating mode the controller will turn on the heating when the room temperature has fallen below a preset hysteresis limit. In this case, as soon as the room temperature exceeds the setpoint of the current operating mode, the feedback control will turn off the heating in the heating mode. Similarly, in cooling mode, the controller will turn on the cooling system when the room temperature has exceeded a preset hysteresis limit. As soon as the room temperature falls below the setpoint of the current operating mode, the feedback control will turn off the cooling system in the cooling mode. Thus, in mixed operation, there is no upper hysteresis limit for heating or no lower one for cooling, respectively, for these values would be in the deadband. Within the deadband, neither heating nor cooling will take place.
- With operating mode change-over via the object, in the heating mode, the controller will turn on the heating when the room temperature has fallen below a preset hysteresis limit. The feedback control will only turn off the heating in the heating mode once the preset upper hysteresis limit has been exceeded. Similarly, in cooling mode, the controller will turn on the cooling system when the room temperature has exceeded a preset hysteresis limit. The feedback control will only turn off the cooling system in the cooling mode once the temperature has fallen below the preset lower hysteresis limit. As with the individual modes of heating or cooling, there are two hysteresis limits per operating mode. Although there is a deadband for the calculation of the temperature setpoints for cooling, it has no influence on the calculation of the two-point control value, as the operating mode is switched over "manually" through the corresponding object. Within the hysteresis spans, it thus will be possible to request heating or cooling energy for temperature values that are located within the deadband.

**i** Also with an automatic operating mode switch, an upper hysteresis limit for heating and a lower hysteresis limit for cooling can be configured in the ETS for 2-point feedback control, although they have no function.

The following two images show 2-point feedback control for the mixed operating mode "Heating and cooling", distinguishing between heating mode (Figure 35) and cooling mode (Figure 36). The images take two temperature setpoints, a non-inverted command value output and an automatic operating mode switchover into account. When the operating mode is switched over

via the object, an upper hysteresis for heating and a lower hysteresis for cooling are active.

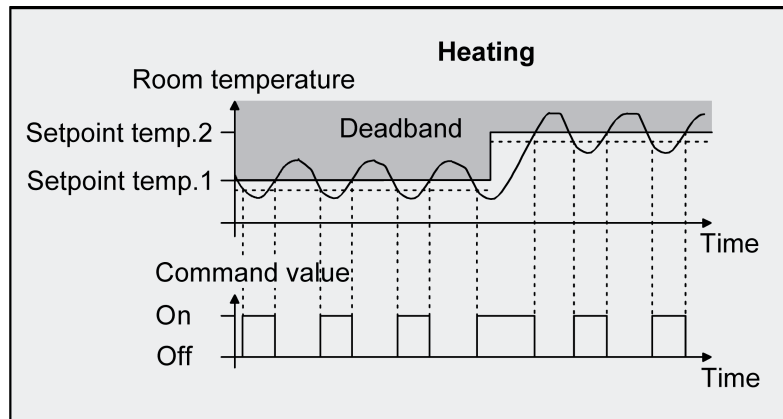

Figure 35: 2-point feedback control for mixed "Heating and cooling" mode with active heating mode.

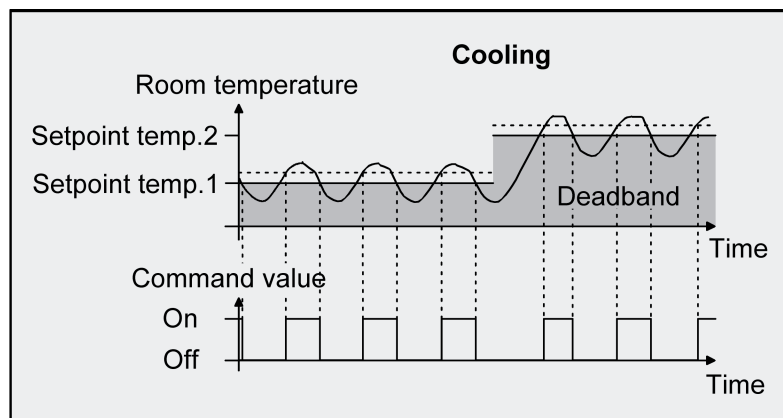

Figure 36: 2-point feedback control for mixed "Heating and cooling" mode with active cooling operation.

Depending on the switching state, the command value "1" or "0" will be output if the values exceed or remain under the hysteresis limits or the setpoints.

- i It has to be pointed out that the message objects for heating and cooling will already become active as soon as the temperature falls short of the temperature setpoint of the active operating mode in case of heating or exceeds the temperature setpoint in case of cooling. In this case the hysteresis is not being considered.

An additional 2-point feedback control heating or cooling level works exactly the same as the 2-point feedback control of the basic level. The difference is that the setpoint and the hysteresis values will shift by taking into account the configured level offset.

## 4.2.4.3.3 Adapting the control algorithms

### Adapting the PI control

In a building, different systems can be installed which heat up or cool down a room. One option is to uniformly heat or cool the surroundings via heat transfer media (preferably water or oil) in connection with room air convection. Such systems are used, for example, with wall mounted heaters, underfloor heating or cooling ceilings. Alternatively or additionally forced air systems may heat or cool rooms. In most cases such systems are electrical forced hot air systems, forced cool air systems or refrigerating compressors with fan. Due to the direct heating of the room air such heating and cooling systems work quite swiftly.

The control parameters need to be adjusted so that the PI control algorithm may efficiently control all common heating and cooling systems thus making the room temperature control work as fast as possible and without deviation. Certain factors can be adjusted with a PI control that can influence the control behaviour quite significantly at times. For this reason, the room temperature controller can be set to predefined control parameters for the most common heating and cooling systems. In case the selection of a corresponding heating or cooling system does not yield a satisfactory result with the default values, the adaptation can optionally be optimised using control parameters.

Predefined control parameters for the heating or cooling stage and, if applicable, also for the additional stages are adjusted via the "type of heating" or "type of cooling" parameters. These fixed values correspond to the practical values of a properly planned and executed air conditioning system and will result in an ideal behaviour of the temperature control. The heating and cooling types shown in the following tables can be set for heating and cooling operation.

Type of heating	Proportional range (preset)	Reset time (preset)	Recommended PI control type	Recommended PWM cycle time
Heat water heating	5 Kelvin	150 minutes	Continuous / PWM	15 min.
Underfloor heating	5 Kelvin	240 minutes	PWM	15-20 min.
Electrical heating	4 Kelvin	100 minutes	PWM	10-15 min.
Fan coil unit	4 Kelvin	90 minutes	Continuous	---
Split unit (split climate control unit)	4 Kelvin	90 minutes	PWM	10-15 min.

Predefined control parameters and recommend control types for heating systems

Cooling type	Proportional range (preset)	Reset time (preset)	Recommended PI control type	Recommended PWM cycle time
Cooling ceiling	5 Kelvin	240 minutes	PWM	15-20 min.
Fan coil unit	4 Kelvin	90 minutes	Continuous	---
Split unit (split climate control unit)	4 Kelvin	90 minutes	PWM	10-15 min.

Predefined control parameters and recommend control types for cooling systems

If the "Type of heating" or "Type of cooling" parameters are set to "Via control parameters", it is possible to adjust the control parameters manually. The feedback control may be considerably influenced by presetting the proportional range for heating or for cooling (P component) and the reset time for heating or for cooling (I component).

- i** Even small adjustments of the control parameters will lead to noticeable different control behaviour.

- i** The adaptation should start with the control parameter setting for the corresponding heating or cooling system according to the specified fixed values mentioned in the above tables.

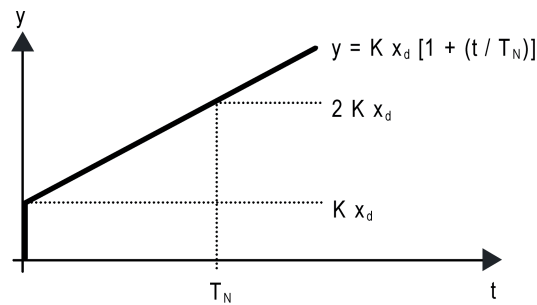

Figure 37: Function of the command value of a PI control

y: Command value  
 $x_d$ : Control difference ( $x_d = x_{set} - x_{act}$ )  
 $P = 1/K$  : Configurable proportional band  
 $K = 1/P$  : Gain factor  
 $T_N$ : Configurable reset time

PI control algorithm: Command value  $y = K x_d [1 + (t / T_N)]$

Deactivation of the reset time (setting = "0") ->  
 P control algorithm: Command value  $y = K x_d$

Parameter setting	Effect
P: Small proportional range	Large overshoot in case of setpoint changes (possibly permanently), quick adjustment to the setpoint
P: Large proportional range	no (or small) overshooting but slow adjustment
$T_N$ : Short reset time	Fast compensation of control deviations (ambient conditions), risk of permanent oscillations
$T_N$ : Long reset time	Slow compensation of control deviations

Effects of the settings for the control parameters

### Adapting the 2-point feedback control

2-point feedback control represents a very simple temperature control. For this type of feedback control, two hysteresis temperature values are set. The upper and lower temperature hysteresis limits can be adjusted via parameters. It has to be considered that...

- A small hysteresis will lead to smaller temperature variations but to a higher KNX bus load.
- A large hysteresis switches less frequently but will cause uncomfortable temperature variations.

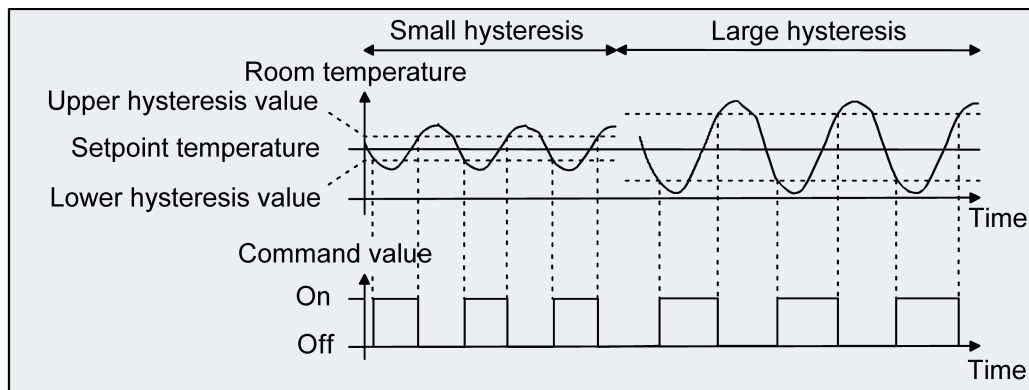









Figure 38: Effects of the hysteresis on the switching behaviour of the command value of 2-point feedback control

## 4.2.4.3.4 Operating mode switchover

### Introduction - The operating modes

The room temperature controller has various operating modes. The selection of these modes will, for example, facilitate the activation of different temperature setpoints, depending on the presence of a person, on the state of the heating or cooling system, on the time of the day, or on the day of the week. The following operating modes can be distinguished...

- Comfort mode   
Comfort mode is usually activated if persons are in a room, and the room temperature should, for this reason, be adjusted to an adequately convenient value. The switchover to this operating mode can take place either by specifying an operating mode via the operating mode switchover or with presence control, for example, using a PIR motion detector on the wall or a ceiling mounted detector.
  - Standby mode   
If a room is not used during the day because persons are absent, you can activate the Standby mode. Thereby, you can adjust the room temperature on a standby value, thus to save heating or cooling energy, respectively.
  - Night operation   
During the night hours or during the absence of persons for a longer time, it mostly makes sense to adjust the room temperature to lower values for heating systems (e.g. in bedrooms). In this case, cooling system can be set to higher temperature values, if air conditioning is not required (e.g. in offices). For this purpose, you can activate the Night mode.
  - Frost/heat protection mode  /   
Frost protection will be required if, for example, the room temperature must not fall below critical values while the window is open. Heat protection can be required where the temperature rises too much in an environment which is always warm, mainly due to external influences. In such cases, you can activate the Frost/heat protection operating mode and prescribe some temperature setpoint of its own for either option, depending on whether "Heating" or "Cooling" has been selected, to prevent freezing or overheating of the room.
  - Comfort extension (temporary Comfort mode)   
You can activate the comfort extension from the night or frost/heat protection mode (not triggered by the "Window status" object) and use it to adjust the room temperature to a comfort value for some time if, for example, there are people in the room during the night hours. This mode can exclusively be activated via the presence object. The comfort extension option will be automatically deactivated after a definable time has elapsed, or by receiving a presence object value = "0". You cannot retrigger this extension.
-  You can assign your own setpoint temperature to the "Heating" or "Cooling" operating modes for each operating mode.

## Operating mode switchover

The operating modes can be switched over by means of the 1-bit communication object available separately for each operating mode, or alternatively, by means of the KNX operating mode objects. The "Operating mode switchover" parameter in the "Room temperature control -> RTCx - General" parameter branch specifies the switching method as follows...

- Operating mode switchover "Via switching (4 x 1-bit)"  
There is a separate 1-bit change-over object for each operating mode. Each of these objects allows the current operating mode to be specified, depending on the priority. Taking a specified priority into account, a specific switchover hierarchy will result from the operating mode switchover by the objects, a distinction being made between presence detection by the presence button (Figure 39) or the presence detector (Figure 40). In addition, the status of the window in the room can be evaluated using the "Window status" object, meaning that, when the window is open, the controller can switch to Frost/heat protection mode, irrespective of the set operating mode, in order to save energy .

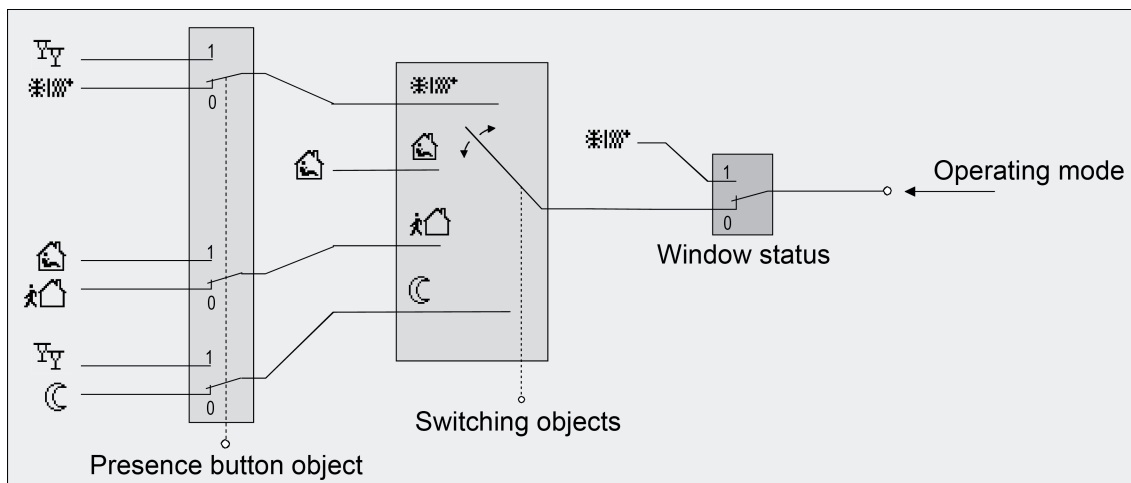

Figure 39: Operating mode change-over through 4 x 1-bit objects with presence button

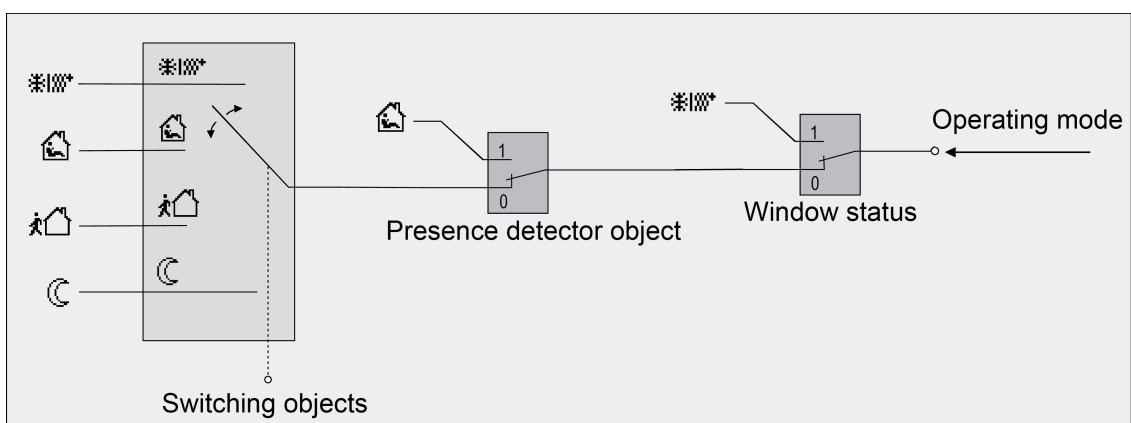







Figure 40: Operating mode change-over through 4 x 1-bit objects with presence detector

Obj.  	Obj. 	Obj. 	Obj. 	Obj. Window status	Pres. button	Pres. detector	Resulting operating mode
1	X	X	X	0	0	-	Frost/heat protection
0	1	X	X	0	0	-	Comfort mode
0	0	1	X	0	0	-	Standby mode
0	0	0	1	0	0	-	Night operation
0	0	0	0	0	0	-	no change
X	X	X	X	1	X	-	Frost/heat protection
1	X	X	X	0	1	-	Comfort extension
0	1	X	X	0	1	-	Comfort mode
0	0	1	X	0	1	-	Comfort mode
0	0	0	1	0	1	-	Comfort extension
0	0	0	0	0	1	-	Comfort mode/extension *
1	X	X	X	0	-	0	Frost/heat protection
0	1	X	X	0	-	0	Comfort mode
0	0	1	X	0	-	0	Standby mode
0	0	0	1	0	-	0	Night operation
0	0	0	0	0	-	0	no change
X	X	X	X	1	-	X	Frost/heat protection
X	X	X	X	0	-	1	Comfort mode

Status of the communication objects and the resulting operating mode

X: Status irrelevant

-: Not possible

\*: Dependent on the last active operating mode.

- i** After bus voltage recovery or an ETS programming operation (controller reset), the object which corresponds to the selected operating mode will be updated and its value actively transmitted to the bus, if the "Transmit" flag has been set.
- i** In parameterisation of a presence button: the presence object will be active ("1") for the period of an comfort extension. The presence object will be automatically deleted ("0") if the comfort extension is stopped after the extension time has elapsed, or if the operating mode was changed by the switchover objects. The controller therefore automatically resets the status of the presence button when an object is received via the operating mode objects.



- Operating mode change-over through "value (1 byte)"

There is a common 1-byte switchover object for all operating modes. During the running time, the operating mode can be changed over through this value object immediately after the receipt of only one telegram. In this connection, the value received will set the operating mode. In addition, a second 1-byte object is available which, by forced control and through a higher level, can set an operating mode, irrespective of any other switchover options. Both 1-byte objects have been implemented according to the KNX specification. Taking the priority into account, a specific switchover hierarchy will result from the operating mode switchover by the objects, a distinction being made between presence detection by the presence button (Figure 41) or the presence detector (Figure 42). In addition, the status of the window in the room can be evaluated using the "Window status" object, meaning that, when the window is open, the controller can switch to Frost/heat protection mode, irrespective of the set operating mode, in order to save energy .

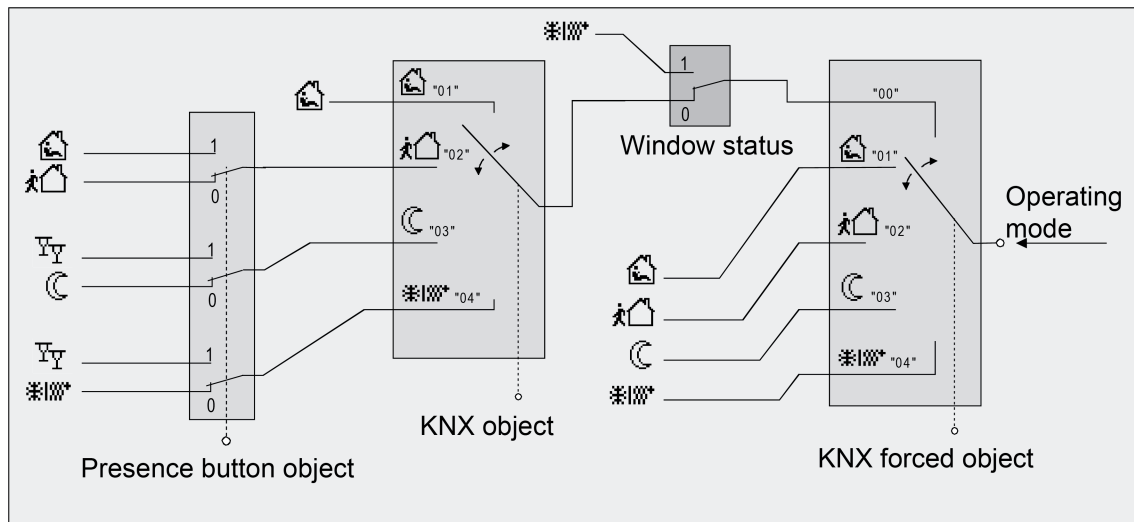

Figure 41: Operating mode switchover through KNX object with presence button

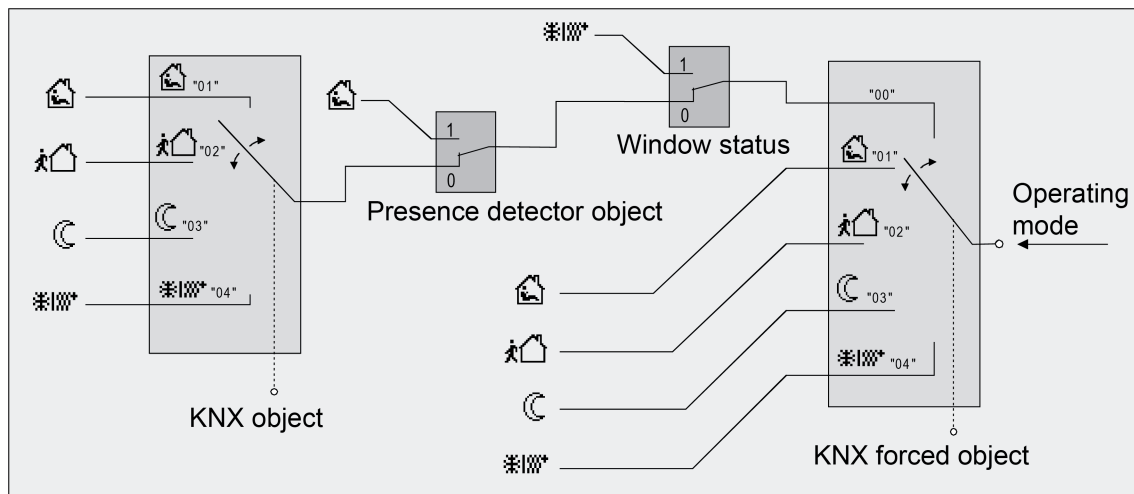

Figure 42: Operating mode switchover through KNX object with presence detector

Object value Operating mode switch-over	Object value Forced object Oper.m.	object Window status	Pres- ence button	Pres- ence detector	Resulting operating mode
00	00	0	X	0	No modification
01	00	0	0	-	Comfort mode
02	00	0	0	-	Standby mode
03	00	0	0	-	Night operation
04	00	0	0	-	Frost/heat protection
01	00	0	1	-	Comfort mode
02	00	0	1	-	Comfort mode
03	00	0	1	-	Comfort ex- tension
04	00	0	1	-	Comfort ex- tension
01	00	0	-	0	Comfort mode
02	00	0	-	0	Standby mode
03	00	0	-	0	Night operation
04	00	0	-	0	Frost/heat protection
X	00	0	-	1	Comfort mode
X	00	1	-	X	Frost/heat protection
X	00	1	X	-	Frost/heat protection
X	01	X	X	X	Comfort mode
X	02	X	X	X	Standby mode
X	03	X	X	X	Night operation
X	04	X	X	X	Frost/heat protection

Status of the communication objects and the resulting operating mode

X: Status irrelevant

-: Not possible

- i** After bus voltage recovery or an ETS programming operation (controller reset), the value which corresponds to the set operating mode is actively transmitted to the bus, if the "Transmit" flag has been set.
- i** In parameterisation of a presence button: the presence object will be active ("1") for the period of an active comfort extension. The presence object will be automatically deleted ("0") if the comfort extension is stopped after the extension time has elapsed, or if the operating mode has been changed by an operation through the switchover objects or a forced operating mode is deactivated by the KNX forced object (forced object -> "00"). The controller therefore automatically resets the status of the presence button when an object value is received via the operating mode objects or the forced object is reset.

## Additional information on the Presence function / Comfort extension

With presence detection, the room temperature controller can quickly switch over to a comfort extension upon push-button actuation using a presence button or, using a presence detector, switch to Comfort mode when movement by a person in the room is detected. In this regard, the "Presence detection" parameter in the "Room temperature control -> RTCx - General -> RTCx - Controller functionality" parameter node sets whether presence detection should be movement-controlled by a motion detector or manual through presence button actuation...

### - Presence detection by the presence button

If the presence button is configured for presence detection, then the 1-bit communication object "Presence button" is enabled. An "ON" telegram to this object makes it possible to switch to the Comfort extension if night operation or frost/heat protection (not activated by the "Window status" object!) is active. The extension will be automatically deactivated as soon as the configured "Length of comfort extension" time has elapsed. A comfort extension can be deactivated in advance if an "OFF" telegram is received via the object of the presence button. You cannot re-trigger such extension time.

If you have set the length of comfort extension to "0" in the ETS, you cannot activate a comfort extension from the night or frost/heat protection mode. In this case, the operating mode will not be changed, although the presence function has been activated.

If the standby mode is active, actuation on a presence object value = "ON" allows a switchover to the Comfort mode. This will also be the case if you have configured the length of comfort extension to "0". Comfort mode will remain active as long as the presence function remains active, or until another operating mode is specified.

The presence function will always be deleted whenever a switchover to a different operating mode takes place, or after a forced operating mode has been deactivated (associated with KNX forced switchover). An active presence function is always deleted on a device reset (bus voltage failure, ETS programming operation).

- i** If, during an active Comfort extension and with a frost/heat protection switchover being configured "via window status", a window is opened, then the controller will activate frost/heat protection immediately. The Comfort extension remains active in the background and the configured time continues to elapse. If the time elapses and the window remains open, the presence is reset and an appropriate telegram is sent to the bus. However, if the window is closed again before the time has elapsed, then the Comfort extension is executed again with the remaining run time.

### - Presence detection by the presence detector

If a presence detector is configured for presence detection, then the 1-bit communication object "Presence detector" is enabled. With this object, it is possible to integrate presence detectors into room temperature control. If a movement is detected ("ON" telegram), the controller will switch to Comfort mode. In this connection, it is irrelevant what has been set by the switchover objects. Only a window contact or the KNX forced object are of higher priority.

After the delay time has elapsed in the presence detector after a detected movement ("OFF" telegram), the controller will return to the mode which was active before presence detection, or it will compensate the telegrams of the operating mode objects received during presence detection, respectively.

E An active presence function is always deleted on a device reset (bus voltage failure, ETS programming operation). In this case, the presence detector must transmit a new "1"-telegram to the controller to activate the presence function.

## Additional information on the window status and the automatic frost protection

The room temperature controller offers various options to change over into the Frost/heat protection mode. In addition to switching over by means of the corresponding operating mode switchover object, frost/heat protection can be activated by a window contact, or alternatively, the frost protection can be activated by an automatic temperature function. The window contact or the automatic function has higher priority. The "Frost/heat protection" parameter in the "Room temperature control -> RTCx - General" parameter branch specifies the way in the switch-over to forced frost/heat protection takes place...

- Frost/heat protection switch-over "via window status"  
The 1-bit object "Window status" is enabled. A telegram having the value of = "ON" (open window) and sent to this object will activate the frost/heat protection mode. If this is the case, the operating mode cannot be deactivated by the switchover objects (except for the KNX forced object) or the presence function. Only a telegram with the value = "OFF" (closed window) will reset the window status and deactivate the frost/heat protection mode. After this, the operating mode set before the opening of the window or that mode carried by the bus while the window was open will be activated.  
You can optionally configure a delay for the evaluation of the window status. Such delay can make sense if short ventilation of the room by opening the window is not supposed to change the operating mode. You can use the "window status delay" parameter to set this delay time between 1 and 255 minutes. The window status will only be changed and thus the frost/heat protection mode activated after this parameterized time has elapsed. A setting of "0" will effect the immediate activation of the frost/heat protection mode when the window is open. The window status will be in effect in the heating and in the cooling mode. After a bus voltage failure or ETS programming operation, the window status is always inactive.
  
  - Frost protection mode switch-over by "automatic frost protection"  
For this setting, automatic switch-over to the frost protection mode can be made at times, depending on the room temperature determined. If there are no window contacts, this setting can prevent unnecessary heating up of a room when windows or external doors are open. With this function, a quick temperature drop can be detected by measuring the actual temperature every minute as, for example, is the case when a window is open in the winter months. You can use the "automatic frost protection temperature drop" parameter to set the maximum temperature drop in K/min for switching over to the frost protection mode. If the controller detects that the room temperature has changed by at least the configured temperature jump within one minute, frost protection will be activated. After the time specified by the "Frost protection period in automatic mode" parameter has elapsed, the controller again automatically switches to the operating mode which was set before frost protection or which was tracked during automatic operation. It is not possible to retrigger an elapsing frost protection period.  
The KNX forced object has a higher priority than the automatic frost protection mode and can interrupt the latter.
- 
- i** The automatic frost protection mode only acts on heating for temperatures below the set value temperature of the operating mode selected. Thus, no automatic switchover to frost protection can take place at room temperatures in the deadband or in the active cooling mode if the "Heating and cooling" operating mode is on. Automatic heat protection activation is not intended with this parameterization.
  - i** Frequent draughts in a room can cause unintentional activation/deactivation of frost protection when the automatic frost protection mode is active and if the set temperature decrease is too low. Therefore switching into the frost/heat protection mode by window contacts should generally be preferred to the automatic option.

## **Additional information on the operating mode after a reset**

In the ETS, it is possible to use the "Operating mode after reset" parameter in the "Room temperature control -> RTCx - General" parameter node to specify which operating mode should be activated after bus voltage return or an ETS programming operation. The following settings are possible...

- "Comfort operation" -> The comfort mode will be activated after the initialisation phase.
- "Standby mode" -> The standby mode will be activated after the initialisation phase.
- "Night operation" -> The night mode will be activated after the initializing phase.
- "Frost/heat protection operation" -> The frost/heat protection mode will be activated after the initialisation phase.
- "Restore operating mode before reset" -> The mode set before a reset according to the operating mode objects will be restored after the initialisation phase of the device. Operating modes set by a function with a higher priority before the reset (Forced, Window status, Presence status) are not effected.

## 4.2.4.3.5 Room temperature measurement

### Basic principles

The controller detects the room temperatures using one or possibly two external KNX temperature sensors (e.g. push-button sensors with temperature measurement). Temperature detection is configured on the parameter page "Room temperature control -> RTCx - General -> RTCx - Room temperature measurement". Depending on the configuration, the 2-byte objects "Received temperature 1 (temperature sensor 1)" and, optionally, "Received temperature 2 (temperature sensor 2)" are enabled.

- i** According to KNX DPT 9.001, the temperature values must be made available to the controller in the format "°C".

When choosing the mounting location of the external temperature sensor, the following points must be considered...

- The temperature sensor should not be used in multiple combinations, especially together with flush-mounted dimmers.
- Do not install the temperature sensor in the area of large electrical consumers (avoid heat influences).
- The push button sensor should not be installed in the vicinity of radiators or cooling systems.
- The temperature sensor should not be exposed to direct sun.
- The installation of sensors on the inside of an outside wall might have a negative impact on the temperature measurement.
- Temperature sensors should be installed at least 30 cm away from doors, windows or ventilation units and at least 1.5 m above the floor.

### Temperature detection and measured value formation

The "Temperature detection of the room controller by" parameter in the "Room temperature control -> RTCx - General -> RTCx - Room temperature measurement" parameter node specifies how many external KNX sensors detect the room temperature. The following settings are possible for temperature detection

- "External temperature value 1"  
The actual temperature is determined solely via an external temperature value. In this case, the KNX temperature sensor is connected to the controller via the 2-byte object "Received temperature 1 (Temperature sensor 1)".  
The controller can request the current temperature value cyclically. For this purpose, the parameter "Request time of the temperature value" must be set to a value > "0". The request interval can be configured within the limits of 1 minute to 255 minutes.  
After a device reset, the controller will first wait for a valid temperature telegram until the feedback control starts and a command value, if applicable, is output.

- "External temperature values 1 + 2"  
The actual temperature is determined using two external temperature values. The selected temperature sources are combined. In this case, the KNX temperature sensors are connected to the controller via the two 2-byte objects "Received temperature 1 (Temperature sensor 1)" and "Received temperature 2 (Temperature sensor 2)".

When evaluating, the real actual temperature is made up of the two temperature values provided. The weighting of the temperature values is defined by the parameter "Measured value formation, temperature value 1 to temperature value 2". Depending on the different locations of the sensors or non-uniform heat distribution inside the room, it is thus possible to adjust the actual temperature measurement. Often, those temperature sensors that are subject to negative external influences (for example, unfavourable location because of exposure to sun or heater or door / window directly next to it) are weighted less heavily.

Example: A temperature sensor has been installed next to the entrance door. An additional temperature sensor has been mounted on an inner wall in the middle of the room below the ceiling.

Sensor 1: 21.5 °C

Sensor 2: 22.3 °C

Determination of measured value: 30 % to 70 %

$$\rightarrow T_{\text{Result 1}} = T_1 \cdot 0.3 = 6.45 \text{ °C},$$

$$\rightarrow T_{\text{Result 2}} = T_2 = 22.3 \text{ °C} \cdot 0.7 = 15.61 \text{ °C}$$

$$\rightarrow T_{\text{Result}} = T_{\text{Result 1}} + T_{\text{Result 2}} = \underline{22.06 \text{ °C}}$$

The controller can request both current temperature values cyclically. For this purpose, the parameter "Polling time of the temperature values" must be set to a value > "0". The request interval can be configured within the limits of 1 minute to 255 minutes.

After a device reset, the controller will first wait for valid temperature telegrams to both objects until control starts and a command value, if applicable, is output.

### Calibrating the measured values

In some cases during room temperature measurement, it may be necessary to adjust the external KNX temperature values. Adjustment becomes necessary, for example, if the temperature measured by the sensors stays permanently below or above the actual room temperature in the vicinity of the sensor. To determine the temperature deviation, the actual room temperature should be detected with a reference measurement using a calibrated temperature measuring device.

The parameters "Calibration of temperature value 1" and "Calibration of temperature value 2" can configure the positive (temperature increase, factors: 1 ... 127) or negative (temperature decrease, factors -128... -1) temperature calibration in levels of 0.1 K. Thus, the calibration is made only once statically and is the same for all operating modes of the controller.

- i** The measured value has to be increased, if the value measured by the sensor lies below the actual room temperature. The measured value has to be decreased, if the value measured by the sensor lies above the actual room temperature.
- i** During room temperature control, the device always uses the adjusted temperature value to calculate the command values. The adjusted temperature value is transmitted to the bus via the "Actual temperature" object. When determining the measured value using both external sensors, the calibrated values are also used to calculate the actual value.
- i** Temperature adjustment only affects the room temperature measurement.

## Transmission of the actual temperature

The determined actual temperature can be actively transmitted to the bus via the 2-byte "Actual temperature" object. The parameter "Transmission when room temperature change by..." specifies the temperature value by which the actual value has to change in order to have the actual temperature value transmitted automatically via the object. Possible temperature value changes lie within a range of 0.1 K and 25.5 K. Setting to "0" at this point will deactivate the automatic transmission of the actual temperature.

In addition, the actual value can be transmitted periodically. The "Cyclical transmission of the room temperature" parameter determines the cycle time (1 to 255 minutes). The value "0" will deactivate the periodical transmission of the actual temperature value. If the "Read" flag is set on the "Actual temperature" object, this makes it possible to read out the current actual value at any time over the bus. It has to be pointed out that with deactivated periodical transmission and deactivated automatic transmission, no more actual-temperature telegrams will be transmitted".

Following the return of bus voltage or after programming via the ETS, the object value will be updated according to the current actual temperature value and transmitted as soon as all the external temperature values of the KNX sensors have been received. If no external temperature values have been received after a reset, then the value "0" will be seen in the "Actual temperature" object. For this reason, all the external temperature sensors should always transmit their current measured temperature value after a reset.

During room temperature control, the controller always uses the calibrated temperature values to calculate the command values. The calibrated temperature values can be actively transmitted to the bus via the "Actual temperature" object.



## 4.2.4.3.6 Temperature setpoints

### Setpoint temperature presetting

Setpoint temperatures can be specified for each operating mode in the ETS as part of configuration. It is possible to configure the setpoints for the "Comfort", "Standby" and "Night" modes directly (absolute setpoint presetting) or relatively (derivation from basic setpoint). The setpoint temperatures can later be adapted during regular operation by KNX communication objects, if desired.

- i** The "Frost/heat protection" operating mode allows the separate configuration of two temperature setpoints for heating (frost protection) and cooling (heat protection) solely in the ETS. These temperature values cannot be changed later during controller operation.

The "Setpoint specification" parameter on the parameter page "Room temperature control -> RTCx - General -> RTCx - Setpoints" defines the way the setpoint temperature is specified...

- "Relative (setpoint temperatures from basic setpoint)" setting:  
When presetting the set-temperatures for comfort, standby and night mode, attention has to be paid to the fact that all setpoints depend on each other as all values are derived from the basic temperature (basic setpoint). The "Basic temperature after reset" parameter on the "Room temperature control -> RTCx - General -> RTCx - Setpoints" parameter page determines the basic setpoint, which is loaded as the specification value when the device is programmed via the ETS. Taking into account the "Reduce / increase the setpoint temperature in Standby mode" or "Reduce / increase the setpoint temperature in Night mode" parameters, the temperature setpoints for the standby and night mode are derived from this value depending on the heating or cooling operating mode. The deadband will be additionally considered for the "Heating and cooling" operating mode.  
The 2-byte object "Basic setpoint" provides the option of changing the basic temperature, and thus all the dependent setpoint temperatures during device operation. A change via the object must always be enabled in the ETS by configuring the parameter "Change the basic temperature setpoint via bus" to "Approve". If the basic setpoint adjustment via the bus is disabled, the "Basic setpoint" object will be hidden. The controller rounds the temperature values received via the object to the specified "Step width of the setpoint shift" (0,1 K or 0,5 K).
- "Absolute (independent setpoint temperatures)" setting  
The setpoint temperatures for comfort, standby and night mode are independent of each other. Depending on the operating mode and heating/cooling mode, various temperature values can be specified in the ETS within the range +7.0 °C to +40.0 °C. The ETS does not validate the temperature values. It is thus possible, for example, to select smaller setpoint temperatures for cooling mode than for heating mode, or to specify lower temperatures for comfort mode than for standby mode.  
After commissioning using the ETS the setpoint temperatures can be changed via the bus by means of temperature telegrams. This can be done using the communication object "Setpoint active operating mode". When the controller receives a telegram via this object, it immediately sets the received temperature as the new setpoint of the active operating mode, and operates from then on with this setpoint. In this manner it is possible to adapt the setpoint temperatures of all operating modes separately for heating and cooling mode. The frost or heat protection temperature programmed in using the ETS cannot be changed in this manner.

- i** With absolute setpoint presetting there is no basic setpoint and also no deadband in the mixed operating mode "Heating and cooling" (if necessary also with additional level). Consequently, the room temperature controller cannot control the switchover of the operating mode automatically, which is why, in this configuration, the setting for the parameter "Switchover between heating and cooling" is fixed in the ETS to "Via object". Furthermore, setpoint shifting does not exist for absolute setpoint presetting.
- i** In two-level control mode, all set-temperatures of the additional level are derived from the setpoint temperatures of the basic level. The setpoint temperature of the additional level are determined by subtracting the "Difference between basic and additional levels", which is permanently configured in the ETS, from the setpoints of the basic level in heating mode or by adding the setpoints in cooling mode. If the temperature setpoints of the basic level are changed, the setpoint temperatures of the additional level will be automatically changed as well. Both levels will heat or cool with the same command value at the same time when the level distance is "0".

The temperature setpoints programmed in the room temperature controller by the ETS during commissioning can be changed via communication objects. In the ETS the parameter "Overwrite setpoints in device during ETS programming operation?" can be used on the parameter page "Room temperature control -> RTCx - General -> RTCx - Setpoints" to define whether the setpoints present in the device, which may have been changed subsequently, are overwritten during an ETS programming operation and are thus replaced again by the values configured in the ETS. If this parameter is "Yes", then the setpoint temperatures are deleted in the device during a programming operation and replaced by the values of the ETS. If this parameter is configured to "No", then setpoints present in the device remain unchanged. The setpoint temperatures entered in the ETS then have no significance.

- i** During initial commissioning of the device the parameter "Overwrite setpoints in device during ETS programming operation?" must be set to "Yes" in order to perform valid initialisation of the memory slots in the device. The setting "Yes" is also necessary if essential controller properties (operating mode, setpoint specification, etc.) are changed in the ETS through new parameter configurations!

### **Setpoint temperatures for relative setpoint presetting**

Depending on the operating mode, different cases should be distinguished when specifying the relative setpoint temperature, which then have an impact on the temperature derivation from the basic setpoint.

#### Setpoints for operating mode "Heating"

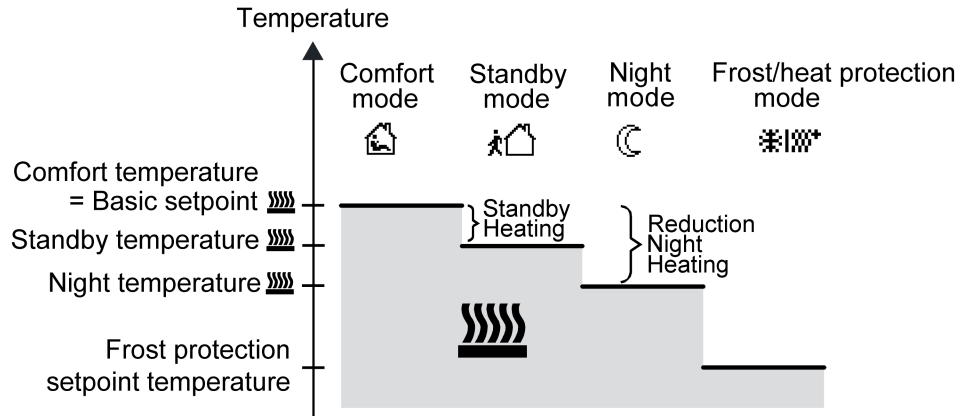

Figure 43: Setpoint temperatures in the operating mode "Heating"

The setpoint temperatures for Comfort, Standby and Night mode exist for this operating mode. The frost protection temperature can be specified (Figure 43). The following applies...

$$T_{\text{Standby setpoint heating}} \leq T_{\text{Comfort setpoint heating}}$$

or

$$T_{\text{Night setpoint heating}} \leq T_{\text{Comfort setpoint heating}}$$

The standby and night setpoint temperatures are derived from the reduction temperatures configured in the ETS from the comfort setpoint temperature (basic setpoint). The frost protection is supposed to prevent the heating system from freezing. For this reason the frost protection temperature (default: +7 °C) should be to a set smaller value than the night temperature. In principle, however, it is possible to select frost protection temperature values between +7.0 °C and +40.0 °C. The possible range of values for a setpoint temperature is bounded by the frost protection temperature in the lower range.

The level offset configured in ETS will be additionally considered in a two-level heating mode (Figure 44).

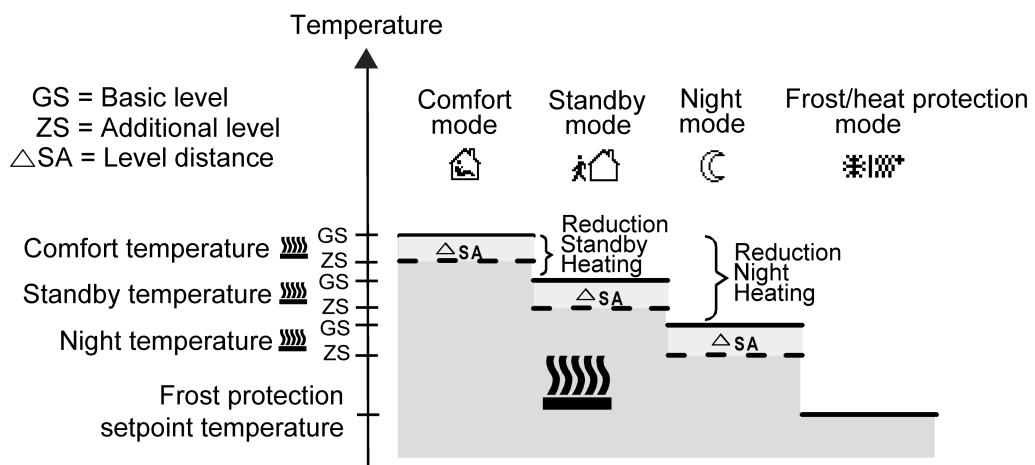

Figure 44: Setpoint temperatures in the operating mode "Basic and additional heating"

$$T_{\text{Comfort setpoint additional level heating}} \leq T_{\text{Comfort setpoint basic level heating}}$$

$$T_{\text{Standby setpoint additional level heating}} \leq T_{\text{Standby setpoint basic level heating}}$$

$$T_{\text{Standby setpoint heating}} \leq T_{\text{Comfort setpoint heating}}$$

or

$$T_{\text{Comfort setpoint additional level heating}} \leq T_{\text{Comfort setpoint basic level heating}}$$

$$T_{\text{Night setpoint additional level heating}} \leq T_{\text{Night setpoint basic level heating}}$$

$$T_{\text{Night setpoint heating}} \leq T_{\text{Comfort setpoint heating}}$$

### Setpoints for the "cooling" operating mode

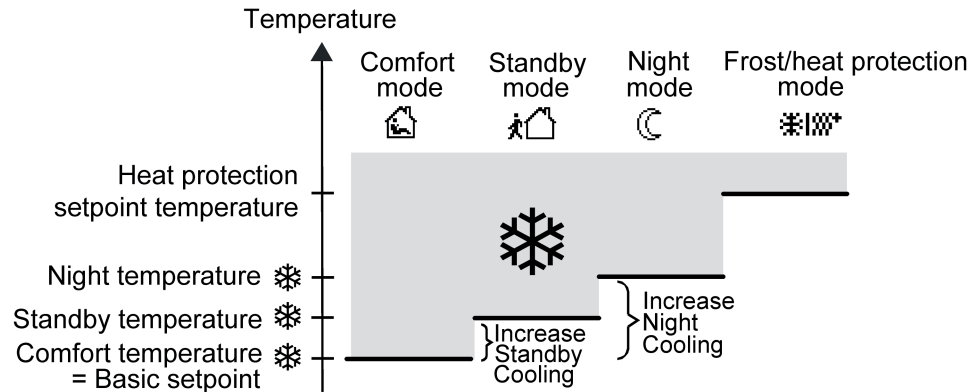

Figure 45: Setpoint temperatures in the operating mode "Cooling"

The setpoint temperatures for Comfort, Standby and Night mode exist in this operating mode and the heat protection temperature can be specified (Figure 45).  
The following applies...

$$T_{\text{Comfort setpoint cooling}} \leq T_{\text{Standby setpoint cooling}}$$

or

$$T_{\text{Comfort setpoint cooling}} \leq T_{\text{Night setpoint cooling}}$$

The standby and night set-temperatures are derived after the configured increase temperatures from the comfort set-temperature (basic setpoint). The heat protection is supposed to ensure that the temperature does not exceed the maximum permissible room temperature in order to protect system components. For this reason the heat protection temperature (default: +35 °C) should be set to a larger value than the night temperature. In principle, however, it is possible to select heat protection temperature values between +7.0 °C and +45.0 °C. The possible range of values for a setpoint temperature is bounded by the heat protection temperature in the upper range.

The level offset configured in ETS will be additionally considered in a two-level cooling mode (Figure 46).

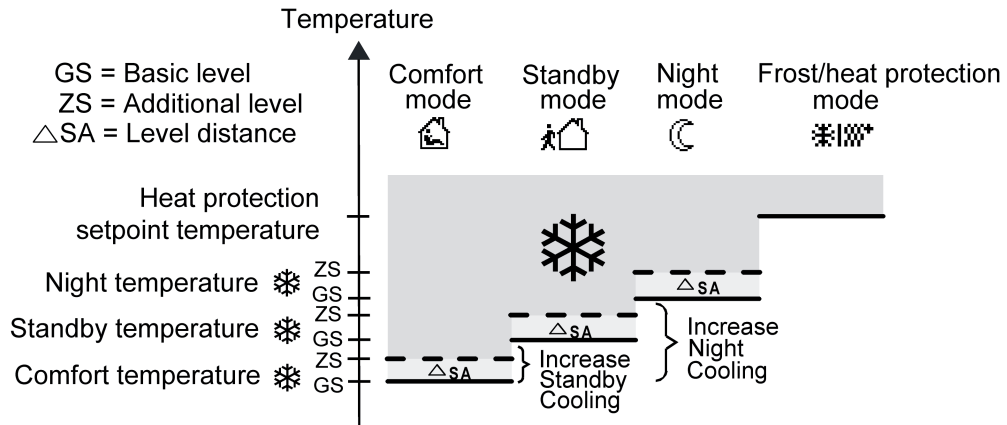

Figure 46: Setpoint temperatures in the operating mode "Basic and additional cooling"

$$T_{\text{Comfort setpoint basic level heating}} \leq T_{\text{Comfort setpoint additional level heating}}$$

$$T_{\text{Standby setpoint basic level heating}} \leq T_{\text{Standby setpoint additional level heating}}$$

$$T_{\text{Comfort setpoint cooling}} \leq T_{\text{Standby setpoint cooling}}$$

or

$$T_{\text{Comfort setpoint basic level heating}} \leq T_{\text{Comfort setpoint additional level heating}}$$

$$T_{\text{Night setpoint basic level heating}} \leq T_{\text{Night setpoint additional level heating}}$$

$$T_{\text{Comfort setpoint cooling}} \leq T_{\text{Night setpoint cooling}}$$

## Setpoints for the "heating and cooling" operating mode

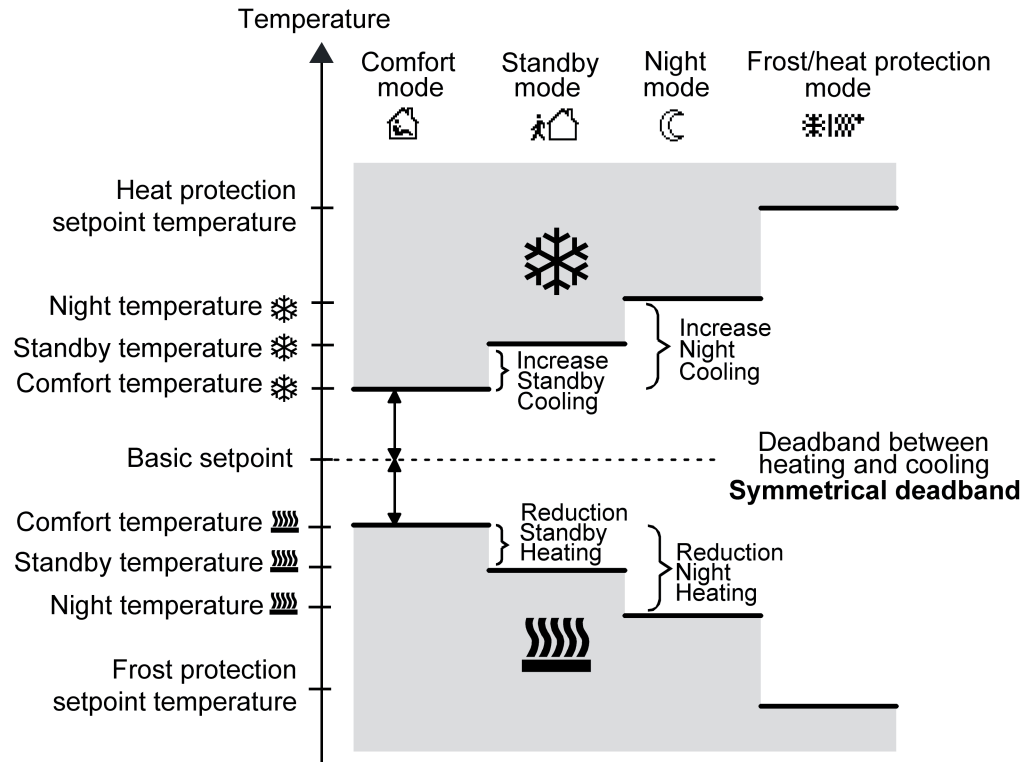

Figure 47: Setpoint temperatures in the operating mode "Heating and cooling" with symmetrical deadband

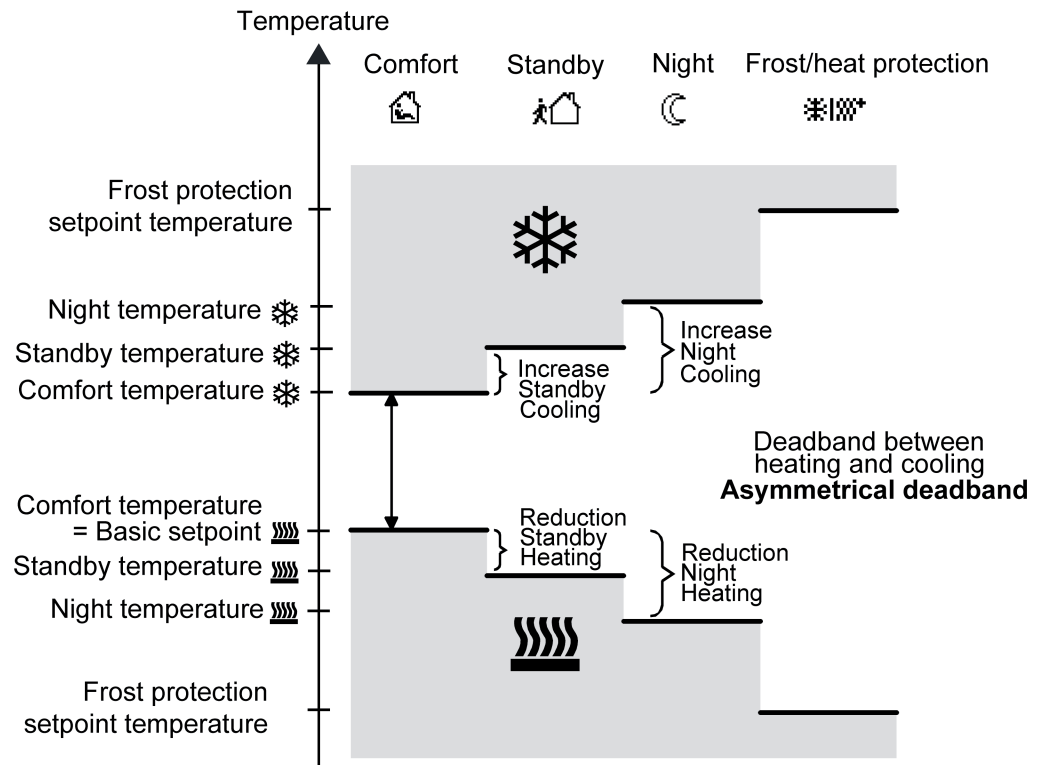

Figure 48: Setpoint temperatures in the operating mode "Heating and cooling" with asymmetrical deadband

For this heating/cooling operating mode, the setpoint temperatures of both heating/cooling modes exist for the Comfort, Standby and Night operating modes as well as the deadband. A distinction is made in the deadband position with combined heating and cooling. A symmetrical (Figure 47) or an asymmetrical (Figure 48) deadband position can be configured. In addition, the frost protection and the heat protection temperatures can be preset.

The following applies...

$$T_{\text{Standby setpoint heating}} \leq T_{\text{Comfort setpoint heating}} \leq T_{\text{Comfort setpoint cooling}} \leq T_{\text{Standby setpoint cooling}}$$

or

$$T_{\text{Night setpoint heating}} \leq T_{\text{Comfort setpoint heating}} \leq T_{\text{Comfort setpoint cooling}} \leq T_{\text{Night setpoint cooling}}$$

The set-temperatures for "Standby" and "Night" are derived from the comfort setpoint temperatures for heating or cooling. The temperature increase (for cooling) and the temperature decrease (for heating) of both operating modes can be preset in ETS. The comfort temperatures itself are derived from the deadband and the basic setpoint.

The frost protection is supposed to prevent the heating system from freezing. For this reason the frost protection temperature (default: +7 °C) should be set to a smaller value than the night temperature for heating. In principle, however, it is possible to select frost protection temperature values between +7.0 °C and +40.0 °C. The heat protection is supposed to prevent the temperature from exceeding the maximum permissible room temperature in order to protect system components. For this reason the heat protection temperature (default: +35 °C) should be set to a larger value than the night temperature for cooling. In principle, however, it is possible to select heat protection temperature values between +7.0 °C and +45.0 °C.

The possible range of values for a setpoint temperature ("heating and cooling") lies between +7.0 °C and +45.0 °C and is bounded by the frost protection temperature in the lower range and by the heat protection temperature in the upper range.

The level offset configured in ETS will be additionally considered in a two-level heating or cooling mode.

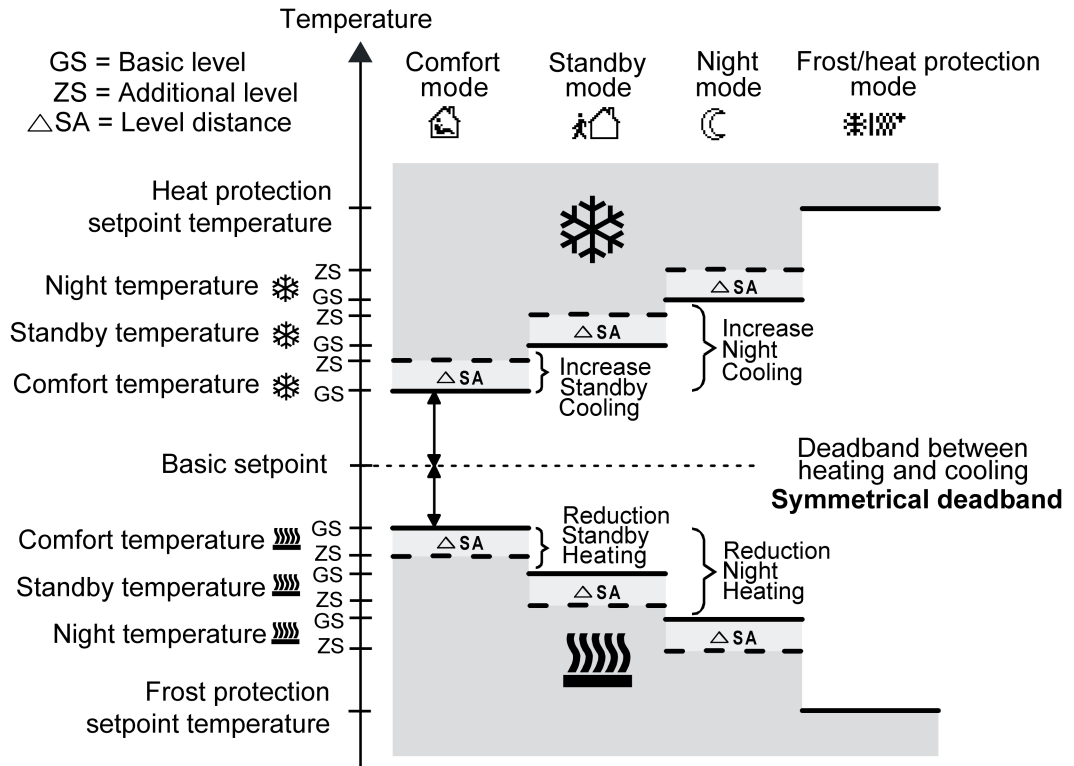

Figure 49: Setpoint temperatures in the operating mode "Basic and additional heating and cooling" with symmetrical deadband



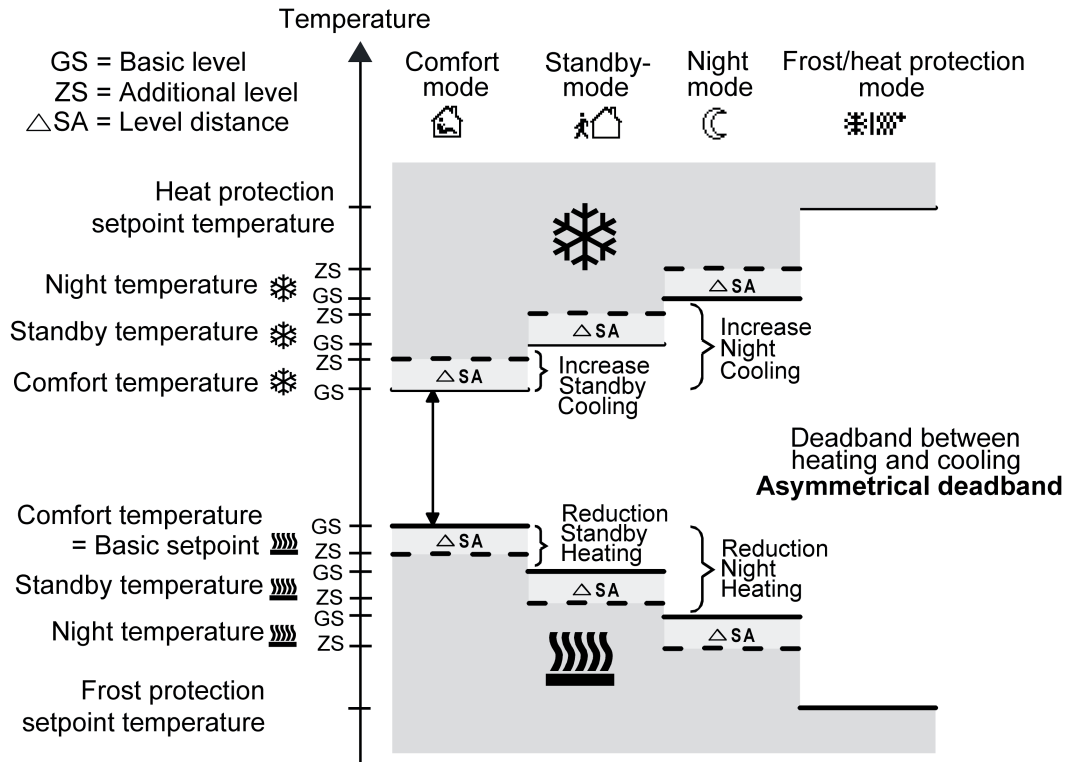

Figure 50: Setpoint temperatures in the operating mode "Basic and additional heating and cooling" with asymmetrical deadband

$$T_{\text{Comfort setpoint add. level Heating}} \leq T_{\text{Comfort setpoint basic level Heating}} \leq T_{\text{Comfort setpoint basic level Cooling}} \leq T_{\text{Comfort setpoint add. level Cooling}}$$

$$T_{\text{Standby setpoint add. level Heating}} \leq T_{\text{Standby setpoint basic level Heating}} \leq T_{\text{Standby setpoint basic level Cooling}} \leq T_{\text{Standby setpoint add. level Cooling}}$$

$$T_{\text{Standby setpoint heating}} \leq T_{\text{Comfort setpoint heating}} \leq T_{\text{Comfort setpoint cooling}} \leq T_{\text{Standby setpoint cooling}}$$

OR

$$T_{\text{Comfort setpoint add. level Heating}} \leq T_{\text{Comfort setpoint basic level Heating}} \leq T_{\text{Comfort setpoint basic level Cooling}} \leq T_{\text{Comfort setpoint add. level Cooling}}$$

$$T_{\text{Night setpoint add. level Heating}} \leq T_{\text{Night setpoint basic level Heating}} \leq T_{\text{Night setpoint basic level Cooling}} \leq T_{\text{Night setpoint add. level Cooling}}$$

$$T_{\text{Night setpoint heating}} \leq T_{\text{Comfort setpoint heating}} \leq T_{\text{Comfort setpoint cooling}} \leq T_{\text{Night setpoint cooling}}$$

### deadband and deadband positions in the combined heating and cooling operating mode

With relative setpoint presetting, the comfort setpoint temperatures for heating and cooling are derived from the basic setpoint in consideration of the adjusted Dead band. The deadband (temperature zone for which there is neither heating nor cooling) is the difference between the comfort setpoint temperatures. This deadband does not exist for absolute setpoint presetting.

The "deadband between heating and cooling", "deadband position" parameters as well as the "Basic temperature after reset" parameter are preset in the ETS configuration. One distinguishes between the following settings...

- deadband = "symmetrical"  
The deadband preset in the ETS is divided into two parts at the basic setpoint. The comfort setpoint temperatures are derived directly from the basic setpoint resulting from the half deadband.

The following applies...

$$T_{\text{Basic setpoint}} - \frac{1}{2}T_{\text{deadband}} = T_{\text{Comfort heating setpoint}}$$

and

$$T_{\text{Basic setpoint}} + \frac{1}{2}T_{\text{deadband}} = T_{\text{Comfort setpoint cooling}}$$

$$\rightarrow T_{\text{Comfort cooling setpoint}} - T_{\text{Comfort heating setpoint}} = T_{\text{deadband}}$$

$$\rightarrow T_{\text{Comfort cooling setpoint}} \geq T_{\text{Comfort heating setpoint}}$$

- deadband position = "Asymmetrical"  
With this setting the comfort setpoint temperature for heating equals the basic setpoint. The deadband preset in the ETS is effective only from the basic setpoint in the direction of comfort temperature for cooling. Thus the comfort set-temperature for cooling is derived directly from the comfort setpoint for heating.

The following applies...

$$T_{\text{Basic setpoint}} = T_{\text{Comfort heating setpoint}}$$

$$\rightarrow T_{\text{Basic setpoint}} + T_{\text{deadband}} = T_{\text{Comfort cooling setpoint}}$$

$$\rightarrow T_{\text{Comfort cooling setpoint}} - T_{\text{Comfort heating setpoint}} = T_{\text{deadband}}$$

$$\rightarrow T_{\text{Comfort cooling setpoint}} \geq T_{\text{Comfort heating setpoint}}$$

## Accept setpoints permanently

If the basic setpoint has been modified by the communication objects "Basic setpoint" or "Setpoint of active operating mode", two possible cases can be distinguished, which are set by the parameter "Permanently apply change to basic temperature setpoint" (with relative setpoint presetting) or "Accept modification of the setpoint permanently" (with absolute setpoint presetting)...

- Case 1: The setpoint adjustment is permanently accepted ("Yes" setting):  
If, with this setting, the setpoint temperature is adjusted, the controller saves the value permanently to the permanent storage. The newly adjusted value will overwrite the initial value, i.e. the basic temperature originally configured via the ETS after a reset or the absolute setpoint temperature loaded using the ETS. The changed values are also retained after a bus voltage failure, after a switchover of the operating mode or after a switchover of the heating/cooling mode (with absolute setpoint specification individually for each operating mode for heating and cooling).  
The "Basic setpoint" object (relative setpoint presetting) is not bidirectional, meaning that a shifted basic setpoint is not signalled back to the KNX.

- Case 2: The basic setpoint adjustment is only temporarily accepted ("No" setting): The setpoints received via the objects remain active only temporarily. In case of a bus voltage failure, after a switchover to another operating mode (e.g. Comfort to Standby, or also Comfort to Comfort), or after a switchover of the heating/cooling mode (e.g. Heating to Cooling), the last setpoint changed will be discarded and replaced by the initial value.

### Basic setpoint shift for relative setpoint presetting

In addition to presetting individual setpoint temperatures by the ETS or the basic setpoint object, the user, when specifying relative setpoints, can shift the basic setpoint in predefined limits within specific limits using the the 1-byte communication object "Setpoint shift specification" (according to KNX DPT 6.010 - Depiction of positive and negative values in a double compliment). By connecting to this object, the controller extensions are, for example, also able to influence the current setpoint shift of the controller directly in steps. As soon as the controller receives a value, it will adjust the setpoint shift correspondingly according to the configured "Step width of the setpoint shift (0.1 K or 0.5 K). Values that lie within the possible value range of the basic setpoint shift can be directly jumped to.

The appropriate current setpoint shift is tracked by the controller in the communication object "Current setpoint shift" with a 1-byte counter value. This object has the same data point type and value range as the object "Setpoint shift specification" (see above). By connecting to this object, suitable controller extensions are also able to display the current setpoint shift and to check the effectiveness of the shift. As soon as a shift by one temperature increment in the positive direction is specified, the controller counts up the value by one digit. The counter value will be counted down by one digit, if there is a negative adjustment of the temperature level. A value of "0" means that no setpoint shifting has been adjusted.

Setpoint shift example:

Starting situation: Current setpoint temperature = 21.0 °C / Counter value in "Current setpoint shift" = "0" (no active setpoint shift) / Step width of the setpoint shift = 0.5 K

After the setpoint shifting:

- > A setpoint shift by one temperature increment in the positive direction will count up the value in the "Current setpoint shift" object by one = "1".
- > Current setpoint temperature = 21.5°C
- > An additional setpoint shift by one temperature increment in the positive direction will again count up the value in the "Current setpoint shift" object by one = "2".
- > Current setpoint temperature = 22.0°C
- > A setpoint shift by one temperature increment in the negative direction will count down the value in the "Current setpoint shift" object by one = "1".
- > Current setpoint temperature = 21.5°C
- > An additional setpoint shift by one temperature increment in the negative direction will again count down the value in the "Current setpoint shift" object by one = "0".
- > Current setpoint temperature = 21.0°C
- > An additional setpoint shift by one temperature increment in the negative direction will again count down the value in the "Current setpoint shift" object by one = "-1".
- > Current setpoint temperature = 20.5°C.

- i** The controller monitors the value received via the "Setpoint shift specification" object automatically. As soon as the external preset value exceeds the limits of the adjustment options for the setpoint shift in positive or negative direction, the controller will correct the received value and adjust the setpoint shift to maximum. Depending on the direction of the shift, the value feedback is set to the maximum value via the communication object "Current setpoint shift".
- i** No basic setpoint shift can be performed if the controller is configured for absolute setpoint presetting.

- i** It has to be considered that a shift of the displayed setpoint temperature (temperature offset of the basic temperature) will directly affect the basic setpoint and as a result shift all other temperature setpoints.  
A positive shift is possible up to the configured heat protection temperature. A negative shift is possible up to the set frost protection temperature.
- i** The "Basic setpoint" object is not bidirectional, meaning that a shifted basic setpoint is not signalled back to the KNX.

Whether a basic setpoint shift only affects the currently active operating mode or whether it influences all other setpoint temperatures of the remaining operating modes is determined by the "Permanently apply change to basic setpoint shift" parameter in the "Room temperature control -> RTCx - General -> RTCx - Setpoints" parameter page...

- "No" setting:  
The basic setpoint shift carried out is in effect for only as long as the operating mode or heating/cooling mode has not changed or the basic setpoint is maintained. Otherwise the setpoint shift will be reset to "0".
- "Yes" setting:  
In general, the shifting of the basic setpoint carried out affects all operating modes. The shift is maintained even after a switchover of the operating mode or the heating/cooling mode or adjusting the basic setpoint.

- i** Since the value for the basic setpoint shift is stored exclusively in volatile memory, the shift will get lost in case of a bus voltage failure or an ETS programming operation.
- i** A setpoint shift does not affect the temperature setpoints for frost or heat protection!
- i** To ensure that controller extensions display the correct shifts and also activate the functions of the main controller correctly, it is necessary for the controller extensions to be set to the same shift limits and step width of the setpoint shift as the main unit. Observe the documentation of the controller extension!

## Transmitting the setpoint temperature

The setpoint temperature, which is specified for the active operating mode, can be actively transmitted onto the bus via the 2-byte "Setpoint temperature" object. The parameter "Send on setpoint temperature change by" in the "Room temperature control -> RTCx - General -> RTCx - Setpoint values" parameter node specifies the temperature value by which the setpoint has to change in order to have the setpoint temperature value transmitted automatically via the object. Possible temperature value changes lie within a range of 0.1 K and 25.5 K. The setting "0" at this point will deactivate the automatic transmission of the setpoint temperature.

In addition, the setpoint can be transmitted periodically. The "Cyclical transmission of setpoint temperature" parameter determines the cycle time (1 to 255 minutes). The value "0" will deactivate the periodical transmission of the setpoint temperature value. It has to be pointed out that with deactivated periodical transmission and deactivated automatic transmission, no setpoint temperature telegrams will be transmitted in case of a change.

Setting the "Read" flag on the "Setpoint temperature" object makes it possible to read out the current setpoint. After a bus voltage return or after programming via the ETS, the object value will be initialised according to the current setpoint temperature and actively transmitted to the bus.

## Limitation of the setpoint temperatures in cooling mode

In accordance with statutory requirements in Germany and elsewhere, the temperature at the workplace should be a maximum of 26 °C, or at least 6 K below outdoor temperatures of 32 °C. Exceeding these limits is only permissible in exception circumstances. To meet these requirements, the room temperature controller offers a setpoint temperature limit, which is only effective in cooling mode. If necessary, the controller limits the setpoint temperature to specific values and prevents an adjustment beyond the limits.

The "Setpoint temperature limit in cooling mode" parameter in the "Room temperature control -> RTCx - General -> RTCx - Setpoints" parameter node can activate the limit and specify its function. The following settings are possible...

- Setting "Only difference to outdoor temperature"  
In this setting, the outdoor temperature is monitored and compared to the active setpoint temperature. The desired maximum temperature difference to the outdoor temperature can be specified in the range between 1 K and 15 K. The specification is made using the "Difference to outdoor temperature in cooling mode" parameter. The value can be set in step widths of 1 K.  
If the outdoor temperature rises above 32 °C in the sense of the statutory requirements, then the controller activates the setpoint temperature limit. It then permanently monitors the outdoor temperature and raises the setpoint temperature so that it is beneath the outdoor temperature by the amount configured. Should the outdoor temperature continue to rise, the controller raises the setpoint temperature until the required difference to the outdoor temperature is achieved. It is then not possible to undershoot the raised setpoint, e.g. by changing the basic setpoint change.  
The change to the setpoint temperature limit is temporary. It only applies for as long as the outdoor temperature exceeds 32 °C.  
With the setpoint temperature limit, the configured temperature difference relates to the setpoint temperature of the Comfort mode for cooling. In other operating modes, the temperature distance to Comfort mode must be taken into account. Example...  
In the ETS, the difference to the outdoor temperature is set to 6 K. The Standby setpoint temperature is configured to 2 K higher than the Comfort setpoint temperature. The result of this is that, for command value limiting, the setpoint temperature in Standby mode may only be a maximum of 4 K below the outdoor temperature. The setpoint temperature limit applies to Night mode in the same way.
- i The automatic setpoint temperature raising by the setpoint temperature limit goes only as far as the configured heat protection temperature. Therefore the heat protection temperature can never be exceeded.
- i A basic setpoint shift never affects an active setpoint temperature limit with differential measurement to the outdoor temperature. In this case, the setpoint temperature limit only works with the unshifted basic setpoint. A setpoint shift active before the limitation is restored after the limitation, if it was not reset in another way, e.g. by an operating mode switchover.

- Setting "Only max. setpoint temperature"  
In this setting, no setpoint temperatures are permitted in Cooling mode related to the Comfort, Standby and Night modes, which are greater than the maximum setpoints configured in the ETS. The maximum setpoint temperature is specified in the "Max. setpoint temperature in Cooling mode" parameter and can be configured within the limits 20 °C to 35 °C in 1 °C steps.  
With an active limit, no larger setpoint can be set in cooling operation, e.g. by a basic setpoint change or a setpoint shift. However, heat protection is not influenced by the setpoint temperature limit.  
The maximum setpoint temperature configured in the ETS generally relates to the Comfort setpoint temperature of Cooling mode. In other operating modes, the temperature distance to Comfort mode must be taken into account. Example...  
The maximum setpoint temperature is configured to 26 °C. The Standby setpoint temperature is configured to 2 K higher than the Comfort setpoint temperature. The result of this is that, for command value limiting, the setpoint temperature in Standby mode is limited to 28 °C. The setpoint temperature limit applies to Night mode in the same way.
- Setting "Max. setpoint temperature and difference to outdoor temperature"  
This setting is a combination of the two above-mentioned settings. In the downward direction, the setpoint temperature is limited by the maximum outdoor temperature difference, whilst in the upward direction, the limit is made by the maximum setpoint. The maximum setpoint temperature has priority over the outdoor temperature difference. This means that the controller keeps on raising the setpoint temperature upwards according to the difference to the outdoor temperature configured in the ETS until the maximum setpoint temperature or the heat protection temperature is exceeded. Then the setpoint is limited to the maximum value.

A setpoint limit enabled in the ETS can be activated or deactivated as necessary using a 1-bit object. For this, the "Activation of the setpoint temperature limit via object in cooling mode" parameter can be set to "Yes". In this case, the controller only takes the setpoint limit into account, if it has been enabled via the object "Cooling setpoint temperature limit" ("1" telegram). If the limitation is not enabled ("0" telegram), the cooling setpoint temperatures are not limited. After a device reset (bus voltage return, ETS programming operation), the object value is "0", meaning that the setpoint limit is inactive.

 The setpoint limit has no function in Heating mode.

## 4.2.4.3.7 Command value and status output

### Command value objects

The format of the command value objects are determined depending on the control algorithm selected for heating and / or cooling and, if applicable, also for the additional levels. 1 bit or 1 byte command value objects can be created in the ETS. The control algorithm calculates the command values in intervals of 30 seconds and outputs them via the objects. With the pulse width-modulated PI control (PWM) the command value is updated, if required, solely at the end of a PWM cycle.

Possible object data formats for the command values separately for both heating/cooling operating modes, for the basic and the additional level or for both control circuits are...

- continuous PI control: 1 byte
- Switching PI control: 1 bit + additionally 1 byte (for example for the status indication with visualisations),
- switching 2-point feedback control: 1 bit.

Depending on the set heating/cooling operating mode, the controller is able to address heating and / or cooling systems, to determine command values and to output them via separate objects. One distinguishes between two cases for the "Heating and cooling" mixed operating mode...

- Case 1: Heating and cooling system are two separate systems  
In this case, the "Transmit heating and cooling command value to one common object" parameter should be set to "no" in the "Room temperature control -> RTCx - General" parameter node. Thus, there are separate objects available for each command value, which can be separately addressed via the individual systems.  
This setting allows to define separate types of control for heating and cooling.
- Case 2: Heating and cooling system are a combined system  
In this case, the "Transmit heating and cooling command value to one common object" parameter may be set, if required, to "yes". This will transmit the command values for heating and cooling to the same object. In case of a two-level feedback control, another shared object will be enabled for the additional levels for heating and cooling.  
With this setting it is only possible to define the same type of feedback control for heating and for cooling as the feedback control and the data format must be identical. The ("Type of heating / cooling") control parameter for cooling and heating still has to be defined separately.  
A combined command value object may be required, for example, if heating as well as cooling shall take place via a single-pipe system (combined heating and cooling system). For this, the temperature of the medium in the single-pipe system must be changed via the system control. Afterwards the heating/cooling operating mode is set via the object (often the single-pipe system uses cold water for cooling during the summer, hot water for heating during the winter).

If required, the actuating variable can be inverted before output. With output via a combined object, the parameters "Output of heating command value", "Output of cooling command value" or "Output of command values..." output the command value in inverted fashion according to the object data format. The parameters for inverting the additional level(s) are additionally available in the two-level control.

The following applies...

For continuous command values:

-> not inverted: Command value 0 % ... 100 %, value 0 ... 255

-> inverted: Command value 0 % ... 100 %, value 255 ... 0

For switching command values:

-> not inverted: Command value off / on, value 0 / 1

-> inverted: Command value off / on, value 1 / 0

## Automatic transmission

On automatic transmission of the command value telegrams, a distinction is made with regard to the type of control...

- **Continuous PI control:**  
In case of a continuous PI control, the room temperature controller calculates a new command value periodically every 30 seconds and outputs it to the bus via a 1-byte value object. The change interval of the command value can be determined in percent according to which a new command value is to be output on the bus via the "Automatic transmission on change by..." parameter in the "Room temperature control -> RTCx - General -> RTCx - Command values and status output" parameter node. The change interval can be configured to "0" so that a change in the command value will not result in an automatic transmission.  
In addition to the command value output following a change, the current command value value may be periodically transmitted. In addition to the times when changes are to be expected, other command value telegrams will be output according to the active value after a configurable cycle time. This ensures that, during cyclical security monitoring of the command value in servo drive or in the addressed switch actuator, telegrams are received within the monitoring time. The time interval predetermined by the "Cycle time for automatic transmission..." parameter should correspond to the control interval in the actuator (cycle time in the controller is preferably to be configured smaller). The "0" setting will deactivate the periodic transmission of the command value.  
With continuous PI control it must be noted that if the cyclical and the automatic transmission are both deactivated, no command value telegrams will be transmitted in case of a change!
- **Switching PI control (PWM):**  
In case of a switching PI control (PWM), the room temperature controller calculates a new command value internally every 30 seconds. With this control, however, the update of the command value takes place, if required, solely at the end of a PWM cycle. The parameters "automatic transmission on change by..." and "Cycle time for automatic transmission..." are not enabled with this control algorithm. The parameter "Cycle time of the switching command value..." defines the cycle time of the PWM command value signal.
- **2-point feedback control:**  
In case of a 2-point feedback control, the room temperature and thus the hysteresis values are evaluated periodically every 30 seconds, so that the command values, if required, will change solely during these times. The "Automatic transmission on change by..." parameter is not enabled as this control algorithm does not calculate continuous command values.  
In addition to the command value output following a change, the current command value value may be periodically transmitted on the bus. In addition to the times when changes are to be expected, other command value telegrams will be output according to the active value after a configurable cycle time. This ensures that, during cyclical security monitoring of the command value in servo drive or in the addressed switch actuator, telegrams are received within the monitoring time. The time interval predetermined by the "Cycle time for automatic transmission..." parameter should correspond to the control interval in the actuator (cycle time in the controller is preferably to be configured smaller). The "0" setting will deactivate the periodic transmission of the command value.

## Command value limit

Optionally a command value limit can be configured in the ETS. The command value limit allows the restriction of calculated command values to the range limits "minimum" and "maximum". The limits are permanently set in the ETS and, if command value limitation is active, can be neither undershot or exceeded during device operation. It is possible, if available, to specify various limiting values for the basic and additional stages and for heating and cooling.



- i** It should be noted that the command value limit has no effect with "2-point feedback control" and with "Transmitting of command values for heating and cooling via a common object"! In that case it is still possible to configure the command value limit in the ETS, but it will have no function.

The "Command value limit" parameter on the parameter page "Room temperature control -> RTCx - General -> RTCx command values and status output" defines the mode of action of the limiting function. The command value limit can either be activated or deactivated using the 1-bit communication object "Command value limit", or be permanently active. When controlling via the object, it is possible to have the controller activate the command value limit automatically after bus voltage return or an ETS programming operation. Here the "Command value limit after reset" parameter defines the initialisation behaviour. In the "Deactivated" setting, the command value limit is not automatically activated after a device reset. A "1" telegram must first be received via the "Command value limit" object for the limit to be activated. In the "Activated" setting, the controller activates the command value limit automatically after a device reset. To deactivate the limit a "0" telegram must be received via the "Command value limit" object. The limit can be switched on or off at any time using the object.

With a permanently active command value limit, the initialisation behaviour cannot be configured separately after a device reset, as the limit is always active. In this case it is also not possible to configure any object.

As soon as the command value limit is active, calculated command values are limited according to the limiting values from the ETS. The behaviour with regard to the minimum or maximum command value is then as follows...

- Minimum command value:  
The "Minimum command value" parameter specifies the lower command value limiting value. The setting can be made in 5 % increments in the range 5 % ... 50 %. With an active command value limit, the set minimum command value is not undershot by command values. If the controller calculates smaller command values, it sets the configured minimum command value. The controller transmits a 0% command value if no more heating or cooling energy has to be demanded.
  
- Maximum command value:  
The "Maximum command value" parameter specifies the upper command value limiting value. The setting can be made in 5 % increments in the range 55 % ... 100 %. With an active command value limit, the set maximum command value is not exceeded. If the controller calculates larger command values, it sets the configured maximum command value.

If the limit is removed, the device automatically repositions the most recently calculated command value to the unlimited values when the next calculation interval for the command values (30 seconds) has elapsed.

- i** An active command value limit has a negative effect on the control result when the command value range is very restricted. A control deviation must be expected.

## Controller status

The room temperature controller can transmit its current status to the KNX. A choice of data formats is available for this. The "Controller status" parameter in the "Room temperature control -> RTCx - General -> RTCx - Command value and status output" parameter branch will enable the status signal and set the status format...

- "KNX compliant"  
The KNX compliant controller status feedback is harmonised on a manufacturer-specific basis, and consists of 3 communication objects. The 2-byte object "KNX status" (DPT 22.101) indicates elementary functions of the controller. This object is supplemented by the two 1-byte objects "KNX status operating mode" and "KNX status forced operating mode" (DPT 20.102), which report back the operating mode actually set on the controller. The last two objects mentioned above are generally used to enable controller extensions to display the controller operating mode correctly in the KNX compliant status display. Therefore, these objects should be connected with controller extensions if the KNX-compliant status feedback is not configured.

Bit of the status telegram	Meaning
0	Controller error status ("0" = no error / "1" = error)
1	not used (permanent "0")
2	not used (permanent "0")
3	not used (permanent "0")
4	not used (permanent "0")
5	not used (permanent "0")
6	not used (permanent "0")
7	not used (permanent "0")
8	Operating mode ("0" = Cooling / "1" = Heating)
9	not used (permanent "0")
10	not used (permanent "0")
11	not used (permanent "0")
12	Controller disabled (dew point operation) ("0" = Controller enabled / "1" = Controller disabled)
13	Frost alarm ("0" = Frost protection temperature exceeded / "1" = frost protection temperature undershot)
14	Heat alarm ("0" = heat protection temperature exceeded / "1" = Heat protection temperature exceeded)
15	not used (permanent "0")

Bit encoding of the 2-byte KNX-compliant status telegram

- "Controller general":  
The general controller status collects essential status information of the controller in two 1-byte communication objects. The "Controller status" object contains fundamental status information. The "Status signal addition" object collects in a bit-orientated manner further information that is not available via the "Controller status" object. For example, controller extensions can evaluate the additional status information, in order to be able to display all the necessary controller status information on the extension display.

Bit of the status telegram	Meaning
0	On "1": Comfort operation activated
1	On "1": Standby mode active
2	On "1": Night mode active
3	On "1": Frost/heat protection mode active
4	On "1": Controller disabled
5	On "1": Heating, on "0": Cooling
6	On "1": Controller inactive (deadband)
7	On "1": Frost alarm ( $T_{\text{Room}} \leq +5 \text{ }^{\circ}\text{C}$ )

Bit encoding of the 1 byte status telegram

Bit of the status telegram	Meaning on "1"	Meaning on "0"
0	Normal operating mode	Forced operating mode
1	Comfort extension active	No comfort extension
2	Presence (Presence detector)	No presence (Presence detector)
3	Presence (Presence button)	No presence (Presence button)
4	Window opened	No window opened
5	Additional level active	Additional level inactive
6	Heat protection active	Heat protection inactive
7	Controller disabled (dew point operation)	Controller not disabled

Bit encoding of the 1 byte additional status telegram

- "Transmit individual state"  
The 1 bit status object "Controller status, ..." contains the status information selected by the "Single status" parameter. Meaning of the status signals:
  - "Comfort mode active": Is "ON" if the "Comfort" operating mode or a Comfort extension is activated.
  - "Standby mode active": Is "ON" if the "Standby" operating mode is activated.
  - "Night mode active": Is "ON" if the "Night" operating mode is activated.
  - "Frost/heat protection active": Is "ON" if the "Frost/heat protection" operating mode is activated.
  - "Controller disabled": Is "ON" if controller disable is activated (dew point mode).
  - "Heating/cooling": Is "ON" if heating is activated and "OFF" if cooling is activated. Is "OFF" if controller is disabled.
  - "Controller inactive" -> Is "ON" in the "Heating and cooling" operating mode when the detected room temperature lies within the deadband. This status information is always "OFF" for the individual "Heating" or "Cooling" operating modes. Is "OFF" if controller is disabled.
  - "Frost alarm" -> Is "ON" if the detected room temperature reaches or falls below +5 °C. This status signal will have no special influence on the control behaviour.

- i Upon a reset, the status objects will be updated after the initialisation phase. After this, updating is performed cyclically every 30 seconds in parallel with the command value calculation of the controller command values. Telegrams are only transmitted to the bus when the status changes.

### **Special case for command value 100% (Clipping mode)**

If with a PI control the calculated command value of the controller exceeds the physical limits of the actuator, in other words if the calculated command value is greater than 100%, then the command value is set to the maximum value (100%) and thus limited. This special, necessary control behaviour is also called "clipping". With PI control the command value can reach the value "100%" if there is a large deviation of the room temperature from the setpoint temperature or the controller requires a long time to adjust to the setpoint with the heating or cooling energy that is being applied. The controller evaluates this state in a particular manner.

The controller maintains the maximum command value only as long as it is necessary. After that it adjusts the command value downwards according to the PI algorithm. The advantage of this control characteristic is the fact that the room temperature does not exceed the setpoint temperature at all, or only slightly. It should be mentioned that this necessary control principle increases the tendency to oscillate about the setpoint.

- i Clipping may also occur when a command value limit is active (maximum command value). In this case, if the internally calculated command value reaches 100%, then the controller only transmits to the bus the maximum command value according to the ETS configuration.

## 4.2.4.3.8 Disabling functions

### Disable controller

Certain operation conditions may require the deactivation of the room temperature control. For example, the controller can be switched-off during the dew point mode of a cooling system or during maintenance work on the heating or cooling system. The parameter "Switch off controller (dew point operation)" in the parameter node "Room temperature control -> RTCx - General -> RTCx - Controller functionality" enables the 1-bit object "Disable controller" when set to "Via bus". In addition, the controller disable function can be switched off when set to "No".

In case a "1" telegram is received via the enabled disable object, the room temperature control will be completely deactivated. In this case, all the command values are equal to "0"/"OFF" (wait 30 s for update interval of the command values). The controller, however, can be operated in this case via the communication objects.

### Disable additional level

The additional stage can be separately disabled when in two-stage heating or cooling mode. When set to "Yes", the "Additional level disabling object" parameter in the "Room temperature control -> RTCx - General" parameter node will enable the 1-bit "Disable additional level" object. In addition, the disable function of the additional level can be switched off when set to "No". In case a "1" telegram is received via the enabled disable object, the room temperature control is completely deactivated by the additional level. The command value of the additional level is "0" while the basic level continues to operate.

-  Disabling operation is always inactive after a device reset (bus voltage return, ETS programming operation).

## 4.2.4.3.9 Underfloor heating temperature limit

The temperature limit can be activated in the controller in order to influence the maximum temperature of an underfloor heating system. If the temperature limit is enabled in the ETS, the controller continuously monitors the floor temperature. Should the floor temperature exceed a specific limiting value on heating, the controller switches the command value off, thus switching the heating off and cooling the system. Only when the temperature falls below the limiting value, minus a hysteresis of 1 K, will the controller add the most recently calculated command value.

In the ETS, the temperature limit can be activated by setting the "Underfloor heating temperature limit available" parameter in the "Room temperature control -> RTCx - General -> RTCx - Controller functionality" parameter node to "Present".

- i** The temperature limit is used to increase the comfort behaviour of the heating system and may not be used as a safety-relevant protection function (immediate forced switch-off of the heating power).
- i** It should be noted that the temperature limit only affects command values for heating. Thus, the temperature limit requires the controller operating modes "Heating" or "Heating and cooling". The temperature limit cannot be configured in the operating mode "Cooling".

The temperature limit can also be used in a two-level feedback control with basic and additional levels. However, it must then be specified in the ETS to which level the limit shall apply. The limit can then either apply to the basic level or to the additional level for heating using the "Affects" parameter.

The underfloor heating temperature to be monitored is fed into the controller via the KNX communication object "Floor temperature". This object can be used to inform the controller of the current floor temperature using suitable temperature value telegrams from other bus devices (e.g. analogue input with temperature sensor, etc.).

The maximum limit temperature, which the underfloor heating system may reach, is specified in the ETS using the "Maximum underfloor heating system temperature" parameter. The temperature can be set to a value between 20 and 70 °C. If this temperature is exceeded, the controller switches the underfloor heating system off using the command value. As soon as the floor temperature has fallen 1 K under the limit temperature, the controller switches the command value on again, assuming that this is intended in the control algorithm. The 1 K hysteresis is fixed and cannot be changed.

- i** The floor temperature limit does not influence the "Heating" message telegram. If the floor temperature exceeds the limiting value, only the command value is switched off. In this case, the "Heating" message remains active.
- i** With a pulse width-modulated command value, the temperature limit only switches off the command value when the current PWM time cycle has elapsed.
- i** Depending on the configuration, the temperature may have a strong impact on the controller behaviour. Poor parameterisation of the limit temperature (limit temperature near to the room/setpoint temperature) means that it is possible that the specified setpoint temperature for the room can never be reached!

## 4.2.4.3.10 Response after a device reset

### Behaviour in case of bus voltage failure

All the functions of the integrated room temperature controller (e.g. setpoint temperature specification, operating mode switchover, switchover of the operating mode) are controlled via communication objects (object controller without its own operating elements), meaning that controller operation is possible via KNX controller extensions or KNX visualisations. The controllers are therefore activated and evaluated like object controllers without their own operating elements.

Communication via the controller objects is only possible when the bus voltage is connected to the device and is ready for operation. If the bus voltage supply fails, the controllers will not function at all. The most recently calculated command values are then rejected.

- i** The device is supplied with energy via the bus voltage and optionally via the mains voltage connection. The valve outputs can also only be activated via the device manual operation when the mains voltage supply exists. The room temperature controllers of the device have no function if supplied only via the mains voltage. In this case, the valve outputs cannot be activated by command values of internal controllers, even if internal group communication is used.

### Behaviour after bus voltage return and ETS programming operation

After the bus voltage supply is switched on or after an ETS programming operation, all the controllers of the device restart and perform an initialisation (controller reset). In this context, various communication objects are updated (e.g. controller status, operating mode). Refer to the appropriate chapters of the function description and the description of the object tables for details on the reset behaviour of individual functions and communication objects.

- i** After a device reset, the controller will first wait for valid temperature telegrams to the input objects of the external KNX temperature sensor until control starts and a command value, if applicable, is output.

#### 4.2.4.4 Delivery state

In the as-delivered state, the actuator is passive, i.e. no telegrams are transmitted to the bus. The outputs can, however, be activated by manual operation on the device, if the bus or mains voltage and the valve voltage supply are on. In the manual control mode, no feedback telegrams are sent to the bus. Other functions of the actuator, such as the room temperature controllers, are deactivated.

The device can be programmed and put into operation via the ETS. The physical address is preset to 15.15.255

Furthermore, the device has been configured at the factory with the following characteristics (all valve outputs)...

- Valve direction of action: deenergised closed
- Pulse width modulation on "Open valve": 50 %
- Cycle time: 20 minutes
- Behaviour on bus failure: Activate command value for emergency operation (30 %), if mains and valve voltage supply available. If the bus and mains voltage fail, all the valve outputs switch OFF.
- Behaviour after bus voltage return: All the valves close (valve outputs switch OFF).

**i** The as-delivered state cannot be restored by unloading the application program with the aid of the ETS. When the application program is removed, all the valve outputs remain permanently switched off. The manual operation remains without function in this case.



## 4.2.5 Parameters

Description	Values	Comment
<p>□ General</p> <p>Setting the parameters of the outputs</p>	<p>all outputs equal</p> <p><b>each output individual</b></p>	<p>To simplify the configuration, all the valve outputs can be assigned to the same parameters in the ETS and thus configured identically. This parameter stipulates whether every valve output of the device can be configured individually or whether all the outputs should be configured by the same parameters.</p> <p>In the "All outputs equal" setting, the number of parameters in the ETS is reduced. The visible parameters are then used on all the valve outputs automatically. Only the communication objects can then be configured separately for the outputs. This setting should be selected, for example, if all the actuators behave identically and should only be activated by different group addresses (e.g. in office blocks or in hotel rooms).</p> <p>In the parameter setting "Each output individually", each valve output possesses its own parameter pages in the ETS.</p>
<p>Number of room temperature controllers used</p>	<p>use no controllers</p> <p>1 controller</p> <p>2 controllers</p> <p>3 controllers</p> <p>4 controllers</p> <p>5 controllers</p> <p><b>6 controllers</b></p>	<p>The actuator contains up to 6 room temperature controllers (RTC), which are integrated in the device software and which work independently of the process. This allows the temperature to be set in up to 6 rooms or room areas to specified setpoints through independent control processes. The number of internal controllers to be used is configured here.</p>
<p>Use internal group communication?</p>	<p>no</p> <p><b>yes</b></p>	<p>The command value outputs of the internal controllers can be internally linked to the electronic valve outputs of the actuator, meaning that temperature control and valve activation can take place using just one bus device, if required. This function is implemented through special internal group communication.</p> <p>Internal group communication interconnects device functions, without using external group addresses which are linked to communication objects. This means that it is possible to link any</p>

			<p>command value outputs of the internal controller with the valve outputs of the actuator via parameters in the application program. If internal group communication is to be used, then this must be enabled centrally here.</p>
Delay after bus voltage return Minutes (0...59)	<b>0...59</b>		
			<p>To reduce telegram traffic on the bus line after bus voltage switch-on (bus reset), after connection of the device to the bus line or after an ETS programming operation, it is possible to delay selected active feedback of the actuator. This parameter defines a delay time independent of the channel for this case. Only after the time configured here has elapsed are status or feedback telegrams for initialisation transmitted to the bus, provided that the status and feedback functions are to be transmitted after a delay. Setting the delay time minutes. Setting the delay time seconds.</p>
		<b>0...17...59</b>	
Time for cycl. transmission of feedback Hours (0...23)	<b>0...23</b>		<p>The transmitting feedback telegrams of the actuator can, depending on the parameterisation, also transmit their state cyclically to the bus. The parameter "Time for cyclical transmission of feedback tel." generally defines the cycle time for all valve outputs. Setting the cycle time hours.</p>
Minutes (0...59)	<b>0...2...59</b>		Setting the cycle time minutes.
Seconds (10...59)	<b>10...59</b>		Setting the cycle time seconds.
Time for cycl. transmission of operating hours Hours (0...23)	<b>0...23</b>		<p>The operating hours counters - depending on the parameterisation - can also transmit their counter value cyclically to the bus. The parameter "Time for cyclical transmission of feedback tel." generally defines the cycle time for all valve outputs. Setting the cycle time hours.</p>
Minutes (0...59)	<b>0...59</b>		Setting the cycle time minutes.
Seconds (10...59)	<b>10...59</b>		Setting the cycle time seconds.
Summer/winter mode switch-over			<p>The actuator possesses a summer / winter switchover. Depending on the season, this allows the setting of</p>

		different command value setpoints for a valve output for emergency operation or forced position.
	<b>no</b>	The summer / winter switch-over is not available. For the valve outputs, only one command value can be configured separately for emergency operation or a forced position.
	<b>yes</b>	The summer / winter switch-over is enabled. The communication object "Summer / winter switch-over" becomes visible in the ETS. Summer and winter command values can be configured for emergency operation and a forced position for the valve outputs.
Polarity of "Summer / winter switch-over" object	1 = Summer / 0 = Winter <b>1 = Winter / 0 = Summer</b>	This parameter sets the telegram polarity of the "Summer / winter switch-over" object. It is only visible when the summer / winter switch-over is enabled.
Operating mode after ETS programming		The "Summer" or "Winter" state preset via the object "Summer / winter switch-over" is stored internally in the device and is restored after a device reset (bus or mains voltage return). The parameter "Operating mode after ETS programming operation" defines which operating mode is active after ETS commissioning.
	Summer mode	In this setting, the actuator activates summer operation after an ETS programming operation. This overwrites the value saved internally in the device.
	Winter mode	In this setting, the actuator activates winter mode after an ETS programming operation. This overwrites the value saved internally in the device.
	<b>no change (saved operating mode)</b>	In this configuration, the actuator activates the most recently saved operating mode.
Use service mode ?		Service mode allows the bus-controlled locking of all or some valve outputs for maintenance or installation purposes. If service mode is active, actuators can be moved to a defined position (completely open or closed) and locked against activation by command value telegrams. Service mode must first be enabled here, so that it can be activated and deactivated via the KNX during actuator operation.
	<b>no</b>	Service mode is not available. No valve outputs can be assigned to service mode in the ETS.

	yes	Service mode is enabled. The communication object "Service mode - Deactivate / activate input" becomes visible. Valve outputs can be assigned on the parameter pages "Ax - assignments".
Behaviour at the end of the service mode	no change	The parameter "Behaviour at the end of service mode" specifies the state to which the affected valve outputs go on deactivating service operation. This parameter is only visible when service operation is used.
	close all outputs completely	
	open all outputs completely	
	<b>track states</b>	
<input type="checkbox"/> Valve / pump Collective feedback status of value outputs (opened / closed) ?	<b>no</b>	After central commands or after bus/mains voltage return, a KNX line is generally heavily loaded by data traffic as many bus devices are transmitting the state of their communication objects by means of feedback telegrams. This effect occurs particularly when using visualisations. Collective feedback can be used to keep the telegram load low during initialisation.
	yes	Collective feedback is deactivated. No collective feedback object is available.
		Collective feedback is enabled. The collective feedback object becomes visible in the ETS.
Collective feedback type		Collective feedback can be provided in the function of an active signalling object or a passive status object. In the case of an active signal object, the feedback is automatically transmitted to the bus whenever the status contained therein changes. In the function as a passive status object, there is no automatic telegram transmission. In this case, the object value must be read out. The ETS automatically sets the object communication flags required for proper functioning. This parameter is visible only if collective feedback is enabled.
	<b>active signalling object</b>	The actuator transmits the collective feedback automatically when the object value is updated. After a device reset (ETS programming operation, bus and mains voltage return, only bus voltage return), current collective feedback is always transmitted.
	passive status object	Collective feedback will only be transmitted in response if the object is

<p>Time delay for feedback telegram after bus voltage return ?</p>	<p><b>no</b>          <b>yes</b></p>	<p>read out from the bus. No automatic telegram transmission of the collective feedback takes place after bus or mains voltage return or after an ETS programming operation.</p> <p>If used as active signal object, the collective feedback is transmitted to the bus after bus and mains voltage return, after just bus voltage return or after an ETS programming operation. In these cases, the feedback can be time-delayed with the time delay being preset globally for all device feedback together on the "General" parameter page. This parameter is visible only if collective feedback is enabled.</p>
<p>Cyclical transmission of the feedback ?</p>	<p><b>no</b>          <b>yes</b></p>	<p>The object of the collective feedback can also transmit its value cyclically in addition to transmission when updating. This parameter is visible only if collective feedback is enabled.</p> <p>Cyclical transmission is deactivated, which means that collective feedback is only transmitted to the bus if one of the valve states changes.</p> <p>Cyclical transmission is activated.</p>
<p>Signal operating voltage failure of the valves?</p>	<p><b>no</b> <b>yes</b></p>	<p>The actuator monitors the power supply of the actuators. On a failure, a 1-bit signal telegram can be transmitted. This parameter enables the feedback function.</p>
<p>Polarity of the object "Failure of operating voltage"</p>	<p><b>0 = Voltage present / 1 = Voltage failed</b>          <b>0 = Voltage failed / 1 = Voltage present</b></p>	<p>This parameter sets the telegram polarity of the signal telegram for the transmission of a failure of the valve operating voltage. It is only visible when "Signal operating voltage failure of the valves ?" = "Yes".</p>

<p>Transmit feedback after bus voltage return ?</p>	<p><b>no</b> <b>yes</b></p>	<p>The object for the transmission of a failure of the valve operating voltage can actively transmit the feedback information after a bus voltage return and an ETS programming operation. This parameter specifies whether active telegram transmission should take place after a device reset or not. This parameter is only visible with "Signal operating voltage failure of the valves?" = "Yes".</p>
<p>Time delay for feedback telegram after bus voltage return ?</p>	<p><b>no</b>  <b>yes</b></p>	<p>The feedback "Failure of operating voltage" is transmitted to the bus after bus and mains voltage return, after just bus voltage return or after programming in ETS. In these cases, the feedback can be time-delayed with the time delay being preset globally for all device feedback together on the "General" parameter page. This parameter is only visible if the signal function is enabled and transmission after bus voltage return is enabled.</p> <p>The feedback "Failure of operating voltage" is transmitted immediately after bus / mains voltage return or after an ETS programming operation.</p> <p>The feedback "Failure of operating voltage" is transmitted with a delay after bus and mains voltage return, after just bus voltage return or after programming in ETS. No feedback is transmitted during a running time delay, even if the state changes.</p>
<p>Cyclical transmission of the feedback if no voltage present ?</p>	<p><b>no</b> <b>yes</b></p>	<p>The signal telegram "Failure of operating voltage" can be transmitted cyclically, should the actuator determine a failed valve operating voltage. This parameter specifies whether cyclical telegram transmission should take place or not. If the valve operating voltage exists, then transmission is generally not cyclical. This parameter is only visible with "Signal operating voltage failure of the valves?" = "Yes".</p>
<p>Global reset of all signals "Short-circuit / overload" ?</p>	<p><b>no</b> <b>yes</b></p>	<p>The actuator is able to detect an overload or a short-circuit at the valve outputs and, in consequence, to protect them against destruction. Outputs which have experienced a short-circuit or a constant load are deactivated after an</p>

<p>Activate function "Heat requirement" ?</p>	<p><b>no</b> yes</p>	<p>identification period. In this case, a short-circuit or overload signal can be transmitted via a KNX communication object. This parameter defines whether a global and thus simultaneous reset of the short-circuit / overload signals of all valve outputs is possible. In the "Yes" setting, the 1-bit communication object "Reset short-circuit / Overload" is available. Individual short-circuit / overload signals can only be reset via the object when the testing cycle (waiting time and testing cycle time) of the affected valve outputs has been completed.</p>
<p>Polarity of "Heat requirement" object</p>	<p><b>0 = No heat requirement / 1 = Heat requirement</b>  0 = Heat requirement / 1 = No heat requirement</p>	<p>The heating actuator can even evaluate the command values of its outputs and make general heat requirement available in the form of limiting value monitoring with hysteresis (1 bit, switching). Using a KNX switch actuator, this allows the energy-efficient activation of burner and boiler controllers with suitable control inputs (e.g. requirement-orientated switch-over between the reduction and comfort setpoint in a central combi boiler). Here, the heat requirement control of the actuator can be enabled centrally ("Yes" setting). The valve outputs must be assigned to the heat requirement control individually on the parameter pages "Ax - Assignments", so that they are included in the requirement determination.</p>
<p>Record external heat requirement ?</p>	<p><b>no</b> yes</p>	<p>The actuator is able to evaluate an external heat requirement (e.g. from another heating actuator). The local heating actuator links the external telegram with the internal status of its own heat requirement logically as OR and outputs the result of this link via the object "Heat requirement". In the "Yes" setting, this parameter will enable the object "External heat requirement". It is visible only if the heat requirement function is enabled.</p>

<p>Limiting value minimum command value for heat requirement (0...100 %)</p>	<p><b>0...100</b></p>	<p>The actuator only signals a heat requirement when at least one command value of the assigned outputs exceeds the limiting value defined here plus the hysteresis (see next parameter). A heat requirement signal is retracted when the limiting value is reached or undershot again. This parameter is visible only if the heat requirement function is enabled.</p>
<p>Hysteresis for limiting value minimum command value (1...20 %)</p>	<p><b>1...10...20</b></p>	<p>This parameter specifies the hysteresis of the limiting value of the minimum command value of the heat requirement control. The actuator signals a heat requirement when a command value exceeds the defined limiting value plus the hysteresis defined here. This parameter is visible only if the heat requirement function is enabled.</p>
<p>Delay heat requirement ACTIVE Hours (0...23)</p>	<p><b>0...23</b></p>	<p>The actuator only outputs the telegram of an active heat requirement after determination when the delay time defined here has elapsed. No heat requirement request is transmitted if the actuator no longer determines a heat requirement within the time preset here. This parameter is visible only if the heat requirement function is enabled. Definition of the delay time hours.</p>
<p>Minutes (0...59)</p>	<p><b>0...5...59</b></p>	<p>Definition of the delay time minutes.</p>
<p>Seconds (0...59)</p>	<p><b>0...59</b></p>	<p>Definition of the delay time seconds.</p>
<p>Delay heat requirement INACTIVE Hours (0...23)</p>	<p><b>0...23</b></p>	<p>The actuator only retracts heat requirement information after determination when the delay time defined here has elapsed. The heat requirement information is not retracted if the actuator no longer determines a new heat requirement within the time preset here. This parameter is visible only if the heat requirement function is enabled. Definition of the delay time hours.</p>
<p>Minutes (0...59)</p>	<p><b>0...5...59</b></p>	<p>Definition of the delay time minutes.</p>
<p>Seconds (0...59)</p>	<p><b>0...59</b></p>	<p>Definition of the delay time seconds.</p>
<p>Activate "Largest command value" function ?</p>	<p><b>no</b> <b>yes</b></p>	<p>The actuator can determine the largest constant command value and forward it to another bus device (e.g. suitable calorific furnaces with integrated KNX control or visualisation). In the "Yes" setting, the heating actuator evaluates</p>



Transmission of the largest command value	<b>only on change</b>	<p>all the active 1-byte command values of the valve outputs and, optionally, the externally received largest command value (object "External largest command value") and transmits the largest command value via the "Largest command value" object.</p> <p>In the case of valve outputs configured in the ETS to the command value data formats "Switching (1-bit)" or "Constant (1-byte) with command value limiting value", there is no evaluation of the command values preset via the bus. Exception: It may also occur with such command value outputs that a constant command value is active (e.g. after bus/mains voltage return or a forced position and emergency operation or manual operation). In this case, this constant command value is also included in the calculation of the largest command value until the named functions with a higher priority are exited or a new command value telegram is received via the bus, overriding the constant command value at the valve output.</p>
	only cyclical	<p>The largest command value determined by the heating actuator is actively transmitted to the bus. This parameter decides when a telegram is transmitted via the "Largest command value" object. This parameter is visible only if the "Largest command value" function is enabled.</p>
	on change and cyclical	<p>A telegram is only transmitted when the largest command value changes.</p> <p>The actuator only transmits the "Largest command value" telegram cyclically. The cycle time is defined globally for all feedback on the parameter page "General".</p> <p>The actuator transmits the "Largest command value" when the object value changes and also cyclically.</p>
Transmit on change by	0.3 %, 0.5 %, 1... <b>3</b> ...20 %	<p>Here, the change interval of the largest command value for automatic transmission is defined. The actuator only transmits a new telegram value when the largest command value has changed by the interval preset here since the last transmission operation. This parameter is visible only if the "Largest command value" function is enabled.</p>

Record external largest command value ?	<b>no</b> yes	<p>The actuator is able to evaluate an external largest control value (e.g. from another heating actuator). The local heating actuator monitors the external telegram with its own active constant command values and outputs the largest of all command values via the object "Largest control value".</p> <p>This parameter will enable the object "External largest command value" in the "Yes" setting. It is only available when the "Largest command value" function is enabled.</p>
Activate "Pump control" function ?	<b>no</b> yes	<p>The heating actuator allows switching activation of the circulation pump of a heating or cooling circuit via a 1-bit KNX telegram.</p> <p>Here, the pump control of the actuator can be enabled centrally ("Yes" setting). The valve outputs must be assigned to the pump control individually on the parameter pages "Ax - Assignments", so that they are included in the control.</p>
Polarity of "Pump control" object	<p><b>0 = Switch off pump /</b> <b>1 = Switch on pump</b></p> <p>0 = Switch on pump/ 1 = Switch off pump</p>	<p>This parameter defines the telegram polarity of the "Pump control" object. It is visible only if the pump control is enabled.</p>
Record external pump control ?	<b>no</b> yes	<p>The actuator is able to evaluate an external pump control signal (e.g. from another heating actuator). The local heating actuator links the external telegram with the internal status of the pump logically as OR and outputs the result of this link via the object "Switch pump".</p> <p>This parameter will enable the object "External pump control" in the "Yes" setting. It is visible only if the pump control is enabled.</p>
Limiting value minimum command value for pump (0...100 %)	<b>0...100</b>	<p>The actuator only switches the pump on when at least one command value of the assigned outputs exceeds the defined limiting value plus the hysteresis defined here (see next parameter). The pump is switched off when the limiting value is reached or undershot again.</p> <p>This parameter is visible only if the pump control is enabled.</p>

Hysteresis for limiting value minimum command value (1...20 %)	<b>1...20</b>	This parameter specifies the hysteresis of the limiting value of the minimum command value of the pump control. The actuator only switches the pump on when a command value exceeds the defined limiting value plus the hysteresis defined here. This parameter is visible only if the pump control is enabled.
Delay pump ACTIVE Minutes (0...59)	<b>0...59</b>	The actuator only outputs the ON telegram to the pump after determination when the delay time defined here has elapsed. The pump is not switched on when the actuator determines within the preset time here that the pump must remain switched off, due to a limiting value plus hysteresis again being undershot. This parameter is visible only if the pump control is enabled. Definition of the delay time minutes.
Seconds (0...59)	<b>0...10...59</b>	Definition of the delay time seconds.
Delay pump INACTIVE Hours (0...23)	<b>0...23</b>	The actuator only outputs the OFF telegram to the pump after determination when the delay time defined here has elapsed. The pump is not switched on when the actuator determines within the preset time here that the pump must remain switched off, due to a limiting value again being exceeded. This parameter is visible only if the pump control is enabled. Definition of the delay time hours.
Minutes (0...59)	<b>0...10...59</b>	Definition of the delay time minutes.
Seconds (0...59)	<b>0...59</b>	Definition of the delay time seconds.
Activate anti-sticking protection	<b>no yes</b>	If pump control is enabled, optional cyclical anti-sticking protection can prevent the sticking of the pump, if it has not been switched on by the command value evaluation for a longer period of time. In the "Yes" setting, this parameter enables cyclical anti-sticking protection.
Time for cyclical switching on of the pump (1...26 weeks)	<b>1...26</b>	When anti-sticking protection is enabled, the length of protection function is defined here. If the pump is not switched on at least once during the time here by the pump controller, then the actuator will executed anti-sticking protection, if necessary on a regular basis.

Switch-on time of the pump (1...15 minutes)	1... <b>5</b> ...15	When anti-sticking protection is enabled, the length of pump running for the cyclical protection function must be preset here. The actuator then switches the pump on for the set time here without interruption, assuming that anti-sticking protection must be executed.
☐ Manual operation		
Manual control in case of bus voltage failure	disabled <b>enabled</b>	This parameter can be used for programming whether manual operation is to be possible or deactivated in case of bus voltage failure (bus voltage switched off).
Manual control during bus operation	disabled <b>enabled</b>	This parameter can be used for programming whether manual operation is to be possible or deactivated during bus operation (bus voltage on).
Disabling function ?	Yes <b>No</b>	Manual control can be disabled via the bus, even if it is already active. For this purpose, the disabling object can be enabled here. This parameter is only visible if manual control is enabled during bus operation.
Polarity of disable object	<b>0 = enabled;</b> <b>1 = disabled</b>  0 = disabled; 1 = enabled	This parameter sets the polarity of the disabling object. This parameter is only visible if manual control is enabled during bus operation.
Transmit status ?	yes <b>no</b>	The current state of manual control can be transmitted to the bus via a separate status object, if bus voltage is available (setting: "Yes"). This parameter is only visible if manual control is enabled during bus operation.
Status object function and polarity	<b>0 = inactive;</b> <b>1 = man.contr.active</b>	This parameter defines the information contained in the status object. The object is always "0", when the manual control mode is deactivated. This parameter is only visible if manual control is enabled during bus operation.  The object is "1" when the manual control mode is active (temporary or permanent).

	<p>0 = inactive; 1 = perman. man. control active</p>	<p>The object is "1" only when the permanent manual control is active.</p>
<p>Behaviour at the end of permanent manual control during bus operation</p>	<p><b>no change</b></p>	<p>The behaviour of the actuator at the end of permanent manual control depends on this parameter. This parameter is only visible if manual control is enabled during bus operation. After the end of the permanent manual operation, the current state of all valve outputs remains unchanged. If, however, a function with a priority lower than that of manual operation (e.g. forced position, service mode) has been activated via the bus before or during manual operation, the actuator sets the reaction preset for this function for the appropriate outputs.</p>
	<p>Output tracking</p>	<p>During active permanent manual operation, all incoming telegrams and state changes are tracked internally. At the end of the manual operation, the valve outputs are set according to the most recently received command or the most recently activated function with a lower priority.</p>
<p>Behaviour of manual operation on bus voltage return</p>	<p><b>Exit manual operation</b></p>	<p>This parameter defines whether an active short-time or permanent manual operation can be terminated, should the bus voltage fail, or not. The following always applies: If the mains voltage supply is not switched on, manual operation is possible if bus voltage is available (valve output can only be activated if a valve power supply is available). If, in this case, the bus voltage is switched off, the actuator also always exits manual operation, as there is no power supply to the device electronics. After the bus voltage return (mains power supply switched off), manual operation is always deactivated. This parameter is only visible if manual control is enabled during bus operation.</p>
	<p>Do not exit manual operation</p>	<p>After the bus voltage return through a mains power supply being available, active manual operation is exited. For example, this means that it is possible to deactivate manual operation through a simultaneous bus reset on multiple actuators with the same parameter setting. After the bus voltage return through a mains power supply being available, active manual operation is never exited.</p>

<p>Disable bus control of individual outputs during bus operation</p>	<p>yes <b>no</b></p>	<p>Individual valve outputs can be disabled locally during permanent manual operation, so that the disabled outputs can no longer be activated using input command value telegrams or lower-priority device functions. Disabling via manual operation is only permitted if this parameter is set to "Yes". This parameter is only visible if manual control is enabled during bus operation.</p>
<p>Cycle time during manual operation</p>	<p>0.5 minutes 1 minute 1.5 minutes 2 minutes ... 19.5 minutes <b>20 minutes (recommended)</b></p>	<p>During manual operation, all the valve outputs are activated with a pulse-width modulation (PWM) using the OPEN button, irrespective of the configured command value data format (1-bit or 1-byte). The cycle time of the PWM signal for a valve output activated by manual operation is configured by this parameter. In consequence, a manual operation locally on the device can allow the use of a different cycle time than in normal operation of the actuator (activation via KNX telegrams). The CLOSE command always closes the valves completely (0 %). An exception is the central operating function of all valve outputs with the ALL OP / CL button. Here, the actuator always activates the valve outputs with a constant signal (0 % or 100 %).</p>
<p>PWM in manual control (5...100 %)</p>	<p>5...<b>50</b>...100</p>	<p>This parameter specifies the pulse-pause ratio of the pulse width modulation of the manual operation for opened valve outputs.</p>

Description	Values	Comment
□ Ax - General		
Valve in voltage-free state (Valve direction of action)	<b>closed</b> open	Valve drives that are closed or open when deenergised can be connected. On each electrical activation of the valve outputs, the actuator takes the valve direction of action configured here into account, so that the command value presets (Valve closed OFF, 0 % / Valve opened ON, 1...100 %) can be executed in the correct direction of action. The valve outputs are no longer energised if the valve voltage supply fails or if there is a short-circuit or overload. The actuator takes this state into account and also influences the command value feedback, according to the configured valve direction of action.
Behaviour after bus voltage failure		If there is a bus voltage failure, the valve outputs perform the configured reaction at this point.
	no change	The command value active before the bus voltage failure remains unchanged.
	Specify command value	The actuator sets the command value preset in the ETS for the valve output by the parameter "Command value on bus voltage failure".
	Activating command as for forced position	For the valve output, the actuator polls the command value preset for the forced position, as configured in the ETS. Here, the active operating mode (summer / winter) is taken into account, providing that a summer / winter change-over is configured. Ensure that, in this setting, the forced position function is not executed! The actuator only polls the command value preset for the forced position.
	<b>Activating command as for emergency operation</b>	For the valve output, the actuator polls the emergency operation command value, as configured in the ETS. Here, the active operating mode (summer / winter) is taken into account, providing that a summer / winter change-over is configured. Ensure that, in this setting, emergency operation is not executed (as would be the case if there was a faulty command value found in the course of command value monitoring)! The actuator only polls the command value preset for emergency operation.

<p>Command value in case of bus voltage failure</p> <p>0 % 5 % 10 % ... 90 % 95 % 100 %</p>	<p>The command value to be set on bus voltage failure is defined here. This parameter is only visible on "Behaviour in case of bus voltage failure" = "Preset command value".</p> <p>For valve outputs configured in the ETS to the command value data formats "Switching (1-bit)" or "Constant (1-byte) with command value limiting value", a constant command value can also be preset using this parameter. In this case, a pulse width modulation (5 % ... 95 %) is executed for the affected command value outputs. In the "0 %" and "100 %" presettings, the valve outputs are activated continuously. The preset PWM remains active until other functions (manual operation, short-circuit/overload) have been executed, which may override the constant command value on the valve output.</p>
<p>Behaviour after bus or mains voltage return</p>	<p>After bus or mains voltage return, the valve outputs perform the configured reaction at this point.</p>
<p><b>Specify command value</b></p>	<p>The actuator sets the command value in the ETS preset for the valve output by the parameter "Command value after bus or mains voltage return".</p>
<p>Activating command as for forced position</p>	<p>For the valve output, the actuator polls the command value preset for the forced position, as configured in the ETS. Here, the active operating mode (summer / winter) is taken into account, providing that a summer / winter change-over is configured.</p> <p>Ensure that, in this setting, the forced position function is not executed! The actuator only polls the command value preset for the forced position.</p>
<p>Activating command as for emergency operation</p>	<p>For the valve output, the actuator polls the emergency operation command value, as configured in the ETS. Here, the active operating mode (summer / winter) is taken into account, providing that a summer / winter change-over is configured.</p> <p>Ensure that, in this setting, emergency operation is not executed (as would be the case if there was a faulty command value found in the course of command value monitoring)! The actuator only polls the command value preset for emergency operation.</p>
<p>Command value as before bus voltage failure</p>	<p>After bus or mains voltage return, that command value is set at the valve output which was active at the moment of the last bus voltage failure. If there is</p>



Command value after bus or mains voltage return	<p><b>0 %</b> 5 % 10 % ... 90 % 95 % 100 %</p>	<p>a bus voltage failure, the actuator saves the active command value internally in the device, so that the command value can be restored when the device power supply returns. Saving only takes place after a previous device reset (ETS programming operation, bus voltage return) when the reset is longer than 30 seconds previously. Otherwise the actuator does not save the current command value! In that case, an old value remains valid, as was previously saved by the actuator on the bus voltage failure. If only the mains power supply fails, the actuator does not save the command value.</p>
Behaviour after ETS programming	Behaviour as after bus voltage return	<p>The command value to be set after bus or mains voltage return is defined here. This parameter is only visible on "Behaviour in case of bus or mains voltage return" = "Preset command value". For valve outputs configured in the ETS to the command value data formats "Switching (1-bit)" or "Constant (1-byte) with command value limiting value", a constant command value can also be preset using this parameter. In this case, a pulse width modulation (5 % ... 95 %) is executed for the affected command value outputs. In the "0 %" and "100 %" presettings, the valve outputs are activated continuously. The preset PWM remains active until other functions have been executed or a new command value telegram is received via the bus, overriding the constant command value on the valve output.</p>
		<p>After an ETS programming operation, the valve outputs perform the configured reaction at this point. After an ETS programming operation, the valve output will behaviour in the manner defined in the parameter "Behaviour after bus or mains voltage return". If the behaviour there is configured to "Command value as before bus voltage failure", then that command value is also set after an ETS programming operation which was active at the time of the last bus voltage failure. An ETS programming operation does not overwrite the saved command value.</p>
		<b>Specify command value</b>

		<p>The actuator sets the command value preset for the valve output by the parameter "Command value after ETS programming operation" in the ETS.</p>
	<p>Activating command as for forced position</p>	<p>For the valve output, the actuator polls the command value preset for the forced position, as configured in the ETS. Here, the active operating mode (summer / winter) is taken into account, providing that a summer / winter change-over is configured.</p>
		<p>Ensure that, in this setting, the forced position function is not executed! The actuator only polls the command value preset for the forced position.</p>
	<p>Activating command as for emergency operation</p>	<p>For the valve output, the actuator polls the emergency operation command value, as configured in the ETS. Here, the active operating mode (summer / winter) is taken into account, providing that a summer / winter change-over is configured.</p>
		<p>Ensure that, in this setting, emergency operation is not executed (as would be the case if there was a faulty command value found in the course of command value monitoring)! The actuator only polls the command value preset for emergency operation.</p>
<p>Command value after ETS programming</p>	<p>0 % 5 % 10 % ... 90 % 95 % 100 %</p>	<p>The command value to be set after an ETS programming operation is defined here. This parameter is only visible on "Behaviour after ETS programming operation" = "Preset command value". For valve outputs configured in the ETS to the command value data formats "Switching (1-bit)" or "Constant (1-byte) with command value limiting value", a constant command value can also be preset using this parameter. In this case, a pulse width modulation (5 % ... 95 %) is executed for the affected command value outputs. In the "0 %" and "100 %" presettings, the valve outputs are activated continuously. The preset PWM remains active until other functions have been executed or a new command value telegram is received via the bus, overriding the constant command value on the valve output.</p>
<p><input type="checkbox"/> Ax - Command value/status/operating mode Data format of the command value input</p>		<p>The heating actuator receives 1-bit or 1-byte command value telegrams, transmitted, for example, by KNX room temperature controllers. Usually, the room temperature controller determines the room temperature and generates the</p>

	<p>command value telegrams using a control algorithm. The actuator controls its valve outputs either in switching form or with a PWM signal, according to the data format of the command values and the configuration in the ETS.</p>
Switching (1 bit)	<p>In the case of a 1-bit command value, the telegram received via the command value object is forwarded directly to the appropriate output of the actuator, taking the configured valve direction of action into account. This means that, if an "ON" telegram is received, the valve is completely opened. The output is then energised for energised closed valves and the output is deenergised for energised opened valve drives. The valve is closed completely when an "OFF" telegram is received. The valve output is then not energised for deenergised closed valves and energised for deenergised opened valve drives.</p>
<b>Constantly (1 byte) with pulse width modulation (PWM)</b>	<p>Command values corresponding to the data format "Constant 1-byte with pulse width modulation (PWM)" are implemented by the actuator with an equivalent pulse width-modulated switch signal at the valve outputs. Taking the cycle time settable in the actuator for each output into account, the average output signal resulting from this modulation is a measure of the centred valve position of the control valve and thus a reference for the set room temperature. A shift of the mean value, and thus a change in the heating capacity, can be obtained by changing the duty factor of the switch-on and switch-off pulses of the output signal. The duty factor is adapted constantly by the actuator, depending on the command value received (normal operation) or by active device functions (e.g. manual operation, forced position, emergency operation).</p>
Const (1 byte) with command value limiting value	<p>The data format with limiting value evaluation can be used as an alternative to the conversion of a 1-byte command value into constant pulse width modulation at a valve output. Here, the received constant command value is converted into a switching output signal, depending on the configured limiting value. The actuator opens when the command value reaches the limiting value or exceeds it. A hysteresis is also evaluated to prevent constant closing and opening of the actuator for command values in the area of the limiting value. The actuator only closes</p>

<p>Cycle time for continuous command value on the valve output</p>	<p>0.5 minutes 1 minute 1.5 minutes 2 minutes ... 19.5 minutes <b>20 minutes (recommended)</b></p>	<p>when the command value undershoots the limiting value minus the configured hysteresis.</p> <p>The "Cycle time" parameter specifies the switching frequency of the pulse-width-modulated output signal of a valve output. It allows adaptation to the adjusting cycle times (the adjusting time it takes the drive to bring the valve from its completely closed to its completely opened position) of the actuators used. In addition to the adjusting cycle time, take account of the dead time (the time in which the actuators do not show any response when being switched or off). If different actuators with different adjusting cycle times are used at an output, take account of the longest of the times.</p> <p>The "Cycle time" parameter is also available for valve drives, whose command value data format is configured to "Switching (1-bit)" or "Constant (1-byte) with command value limiting value". For such valve outputs, pulse width modulation can also be executed during an active forced position, emergency operation, manual operation, bus voltage failure, after bus or mains voltage return or after an ETS programming operation, for which, as a result, the presetting of a cycle time is required.</p>
<p>Limiting value of the command value for opening the valve (1...100 %)</p>	<p>1...<b>10</b>...100</p>	<p>In the 1-byte command value data with limiting value evaluation, the received constant command value is converted into a switching output signal, depending on the limiting value configured here. The actuator opens when the command value reaches the limiting value or exceeds it.</p> <p>This parameter is only available in the command value data format "Switching (1-byte) with command value limiting value".</p>
<p>Hysteresis limiting value for closing the valve (1...10 %)</p>	<p>1...<b>5</b>...10</p>	<p>In the 1-byte command value data with limiting value evaluation, the received constant command value is converted into a switching output signal. A hysteresis is also evaluated to prevent constant closing and opening of the actuator for command values in the area of the limiting value. The actuator only closes when the command value undershoots the limiting value minus the</p>

		configured hysteresis. This parameter is only available in the command value data format "Switching (1-byte) with command value limiting value".
Activate command value monitoring ?	<b>no</b> yes	Here, cyclical monitoring of the command values can be enabled as an option ("Yes" setting). If, in active cyclical monitoring, there are no command value telegrams during the monitoring time preset by the parameter of the same name, then emergency operation is activated for the affected valve output, for which a configurable constant PWM command value can be preset.
Monitoring time Minutes (0...59)	0... <b>10</b> ...59	This parameter specifies the monitoring time of the command value monitoring. The actuator must receive at least one command value telegram within the time frame specified here. If there is no command value telegram, then the actuator will assume a fault and will activate emergency operation for the affected valve output. This parameter is only available if command value monitoring is enabled. presetting of the monitoring time minutes.
Seconds (10...59)	<b>10</b> ...59	presetting of the monitoring time seconds.
Polarity of "Command value fault" object	<b>0 = No fault / 1 = Fault</b>  0 = Fault / 1 = No fault	If a command value fault is identified, then the actuator can optionally transmit a fault telegram via the object "Command value fault". This parameter defines the telegram polarity of the fault telegram. This parameter is only available if command value monitoring is enabled.
Cyclical transmission in the case of faulty command value ?	<b>no</b> yes	If a command value fault is identified, then the actuator can optionally transmit the fault telegram cyclically. Here, the cyclical transmission of the fault telegram can be enabled as required ("Yes" setting). This parameter is only available if command value monitoring is enabled.
	0 % 10 %	When a fault in the input command value is detected and also in the case of

<p>Command value in the case of emergency operation</p>	<p>... <b>30 %</b> ... 90 % 100 %</p>	<p>a bus voltage failure, after bus or mains voltage return and after an ETS programming operation (configurable), it is possible to set the emergency operation command value configured here as the active command value. When the command value of emergency operation is polled, valve outputs configured to the command value data formats "Switching (1-bit)" or "Constant (1-byte) with command value limiting value" are always activated by a constant command value with pulse width modulation. This parameter is only available when no summer / winter switch-over is planned.</p>
<p>Command value in the case of emergency operation Summer</p>	<p>0 % 10 % ... <b>30 %</b> ... 90 % 100 %</p>	<p>When a fault in the input command value is detected and also in the case of a bus voltage failure, after bus or mains voltage return and after an ETS programming operation (configurable), it is possible to set the emergency operation command value configured here as the active command value. The command value preset here is only applied if summer operation is activated. When the command value of emergency operation is polled, valve outputs configured to the command value data formats "Switching (1-bit)" or "Constant (1-byte) with command value limiting value" are always activated by a constant command value with pulse width modulation. This parameter is only available when a summer / winter switch-over is planned.</p>
<p>Command value in the case of emergency operation Winter</p>	<p>0 % 10 % ... <b>70 %</b> ... 90 % 100 %</p>	<p>When a fault in the input command value is detected and also in the case of a bus voltage failure, after bus or mains voltage return and after an ETS programming operation (configurable), it is possible to set the emergency operation command value configured here as the active command value. The command value preset here is only applied if winter mode is activated. When the command value of emergency operation is polled, valve outputs configured to the command value data formats "Switching (1-bit)" or "Constant (1-byte) with command value limiting value" are always activated by a constant command value with pulse width modulation. This parameter is only available when a summer / winter switch-over is planned.</p>

<p>Command value in the case of forced position</p>	<p>0 % 10 % ... <b>30 %</b> ... 90 % 100 %</p>	<p>When forced operation is activated via a 1-bit object and also in the case of a bus voltage failure, after bus or mains voltage return and after an ETS programming operation (configurable), it is possible to set the forced command value configured here as the active command value.</p> <p>When the command value of the forced position is polled, valve outputs configured to the command value data formats "Switching (1-bit)" or "Constant (1-byte) with command value limiting value" are always activated by a constant command value with pulse width modulation.</p> <p>This parameter is only available when no summer / winter switch-over is planned.</p>
<p>Command value in the case of forced position Summer</p>	<p>0 % 10 % ... <b>30 %</b> ... 90 % 100 %</p>	<p>When forced operation is activated via a 1-bit object and also in the case of a bus voltage failure, after bus or mains voltage return and after an ETS programming operation (configurable), it is possible to set the forced command value configured here as the active command value. The command value preset here is only applied if summer operation is activated.</p> <p>When the command value of the forced position is polled, valve outputs configured to the command value data formats "Switching (1-bit)" or "Constant (1-byte) with command value limiting value" are always activated by a constant command value with pulse width modulation.</p> <p>This parameter is only available when a summer / winter switch-over is planned.</p>
<p>Command value in the case of forced position Winter</p>	<p>0 % 10 % ... <b>70 %</b> ... 90 % 100 %</p>	<p>When forced operation is activated via a 1-bit object and also in the case of a bus voltage failure, after bus or mains voltage return and after an ETS programming operation (configurable), it is possible to set the forced command value configured here as the active command value. The command value preset here is only applied if winter mode is activated.</p> <p>When the command value of the forced position is polled, valve outputs configured to the command value data formats "Switching (1-bit)" or "Constant (1-byte) with command value limiting value" are always activated by a</p>

		constant command value with pulse width modulation. This parameter is only available when a summer / winter switch-over is planned.
Use object for forced position ?	<b>no</b> yes	A forced position can be configured separately for each valve output here and activated according to requirements. If a forced position is active, a defined command value is set at the output (see parameter "Command value in case of forced position..."). Affected valve outputs are then locked so that they can no longer be activated using functions subject to the forced position (including activation by command value telegrams). For each valve output, the forced position is activated and deactivated via a separate 1-bit object. This parameter will enable the object (setting "Yes").
Polarity of "Forced position" object	<b>0 = No forced pos. / 1 = Forced pos. active</b>  0 = Forced pos. active / 1 = No forced pos.	The telegram polarity of the "Forced position" object is defined here when the forced position object is enabled.
Feed back valve command value ?	<b>no</b> yes	A status object can be optionally enabled here ("Yes" setting) for each valve output. The status object makes the active command value of a valve output available either actively transmitting or passively (object can be read out). During status feedback, the actuator takes all the functions into account which have an influence on the command value implemented at the output.
Type of feedback		The status feedback can be used as an active signal object or as a passive status object. As an active signal object, the feedback is also directly transmitted to the bus whenever there is a change to the status value. As a passive status object, there is no telegram transmission after a change. In this case, the object value must be read out. The ETS automatically sets the communication flags of the status objects required for proper functioning. This parameter is only visible in case of enabled status feedback.
	<b>active signalling object</b>	



		<p>The feedback telegram is transmitted as soon as the status changes. An automatic telegram transmission of the feedback takes place after bus voltage return, if the supply voltage of the actuators fails and returns or after an ETS programming operation (possibly with a delay). The status object does not transmit if the status does not change after the activation or deactivation of device functions or new input command values. Transmission only ever takes place after changes to the command value.</p>
	<p>passive status object</p>	<p>The feedback telegram will only be transmitted in response if the status object is read out from the bus by a read telegram. No automatic telegram transmission of the feedback takes place after bus voltage return, if the supply voltage of the actuators fails and returns or after an ETS programming operation.</p>
<p>Time delay for feedback telegram after bus voltage return ?</p>		
	<p>yes</p>	<p>If used as active signal object, the state of the status feedback information is transmitted to the bus after bus voltage return or after an ETS programming operation. In these cases, feedback can be time-delayed with the time delay being preset globally for all valve outputs together on the "General" parameter page. This parameter is only visible in case of an enabled status feedback and only when the object is actively transmitting.</p>
	<p>no</p>	<p>The status feedback will be transmitted with a delay after bus voltage return or after an ETS programming operation. No feedback is transmitted during a running time delay, even if the valve state changes during this delay. If the supply voltage of the actuators fails and returns, then the status feedback is always transmitted without a delay, providing that the bus voltage supply is switched on.</p>
<p>Cyclical transmission of the feedback ?</p>		
		<p>The status feedback telegram can also be transmitted cyclically via the active signal object in addition to the transmission after changes. This parameter is only visible in case of</p>

		<p>an enabled status feedback and only when the object is actively transmitting.</p>
	yes	<p>Cyclical transmission is activated. The cycle time is defined centrally for all the valve outputs on the parameter page "General". There is no cyclical transmission during an active time delay after bus voltage return or an ETS programming operation.</p>
	no	<p>Cyclical transmission is deactivated so that the feedback telegram is transmitted to the bus only when the status is changed by the actuator.</p>
Feedback combined valve status ?	no yes	<p>The combined valve status allows the collective feedback of various functions of a valve output in a single 1-byte bus telegram. It helps to forward the status information of an output to a suitable recipient (e.g. KNX visualisation) in a targeted manner, without having to evaluate various global and channel-orientated feedback and status functions of the actuator. The communication object "Feedback combined valve status" contains 7 different items of status information, which are bit-encoded. In the "Yes" setting, this parameter enables the combined valve status.</p>
Type of combined status feedback		<p>The combined valve status can be used as an active signal object or as a passive status object. As an active signal object, the feedback is also directly transmitted to the bus whenever there is a change to the status value. As a passive status object, there is no telegram transmission after a change. In this case, the object value must be read out. The ETS automatically sets the communication flags of the status objects required for proper functioning. This parameter is only available if the combined valve status is enabled.</p>
	<b>active signalling object</b>	<p>The feedback telegram is transmitted as soon as the status changes. Automatic telegram transmission of the feedback takes place after bus voltage return and after an ETS programming operation (possibly with a time delay). The combined status object does not transmit if the status information does not change after the activation or deactivation of device functions or new input command values. Only changes are ever transmitted. If the supply</p>

	passive status object	<p>voltage of the actuators fails and returns, then the combined status feedback is not transmitted.</p> <p>The feedback telegram will only be transmitted in response if the status object is read out from the bus by a read telegram. No automatic telegram transmission of the feedback takes place after bus voltage return or after programming with the ETS.</p>
Time delay for feedback telegram after bus voltage return ?	yes	<p>If used as active signal object, the state of the combined status feedback information is transmitted to the bus after bus voltage return or after an ETS programming operation. In these cases, feedback can be time-delayed with the time delay being preset globally for all valve outputs together on the "General" parameter page.</p> <p>This parameter is only available if the combined valve status is enabled.</p> <p>The status feedback will be transmitted with a delay after bus voltage return or after an ETS programming operation. No feedback is transmitted during a running time delay, even if the valve state changes during this delay. If the supply voltage of the actuators fails and returns, then the status feedback is always transmitted without a delay, providing that the bus voltage supply is switched on.</p>
	no	<p>The status feedback will be transmitted immediately after bus voltage return or after an ETS programming operation.</p>
Cyclical transmission of the feedback ?	yes	<p>The combined status feedback telegram can also be transmitted cyclically via the active signal object in addition to the transmission after changes.</p> <p>This parameter is only available if the combined valve status is enabled.</p> <p>Cyclical transmission is activated. The cycle time is defined centrally for all the valve outputs on the parameter page "General". There is no cyclical transmission during an active time delay after bus voltage return or an ETS programming operation.</p>
	no	<p>Cyclical transmission is deactivated so that the feedback telegram is transmitted to the bus only when the status is changed by the actuator.</p>

<p>Signalling short-circuit / overload ?</p>	<p><b>no</b> yes</p>	<p>The actuator is able to detect an overload or a short-circuit at the valve outputs and, in consequence, to protect them against destruction. Outputs which have experienced a short-circuit or a constant load are deactivated after an identification period. In this case, a short-circuit or overload signal can be transmitted via a KNX communication object. In the "Yes" setting, this parameter enables the object "Short-circuit / overload signal".</p>
<p>Polarity of object "Short-circuit / overload"</p>	<p><b>0 = No short-cir, overlD. / 1 = Short-cir, overlD.</b>  0 = Short-cir, overlD. / 1 = No short-cir, overlD.</p>	<p>When the object for short-circuit / overload messaging is enabled, the telegram polarity of the "Short-circuit / overload signal" object is defined here.</p>
<p>Output reacts to command value from</p>	<p>Controller 1 Controller 2 Controller 3 Controller 4 Controller 5 Controller 6 No internal command value</p>	<p>The actuator contains up to 6 room temperature controllers (RTC), which are integrated in the device software and which work independently of the process. The command value outputs of these controllers can be internally linked to the electronic valve outputs of the actuator, meaning that temperature control and valve activation can take place using just one bus device, if required. Internal group communication interconnects device functions, without using external group addresses which are linked to communication objects. This means that it is possible to link any command value outputs of the internal controller with the valve outputs of the actuator via parameters in the application program. The precondition is that the data formats (1-bit / 1-byte) of the command value inputs and outputs to be linked are identical. An internal controller must be selected here, to whose command values an assignment of the valve output is to occur. In the "No internal command value" setting, the internal group communication of the selected valve output is deactivated. In this case, the output can only be activated using the external communication objects. The presetting of this parameter is dependent on the selected valve output and also dependent on which controllers are enabled. This parameter is only visible when internal group communication is used.</p>

<p>Command value for valve output (switching 1 bit)</p>	<p>Controller x Command value heating</p>	<p>The required switching command value of the chosen internal controller must be selected here. This makes it possible, depending on the application, to assign the valve output to available internal command values of the appropriate data format. The presetting of this parameter and the available selection of the settings is dependent on the configuration of the selected controller. A selection is then only possible with this parameter when the selected internal controller possesses switching command values.</p>
	<p>Controller x Command value basic level heating</p>	
	<p>Controller x Command value additional level heating</p>	
	<p>Controller x Command value basic level</p>	
	<p>Controller x Command value cooling</p>	
	<p>Controller x Command value basic level cooling</p>	
	<p>Controller x Command value additional level cooling</p>	
	<p>Controller x Command value additional level</p>	
<p>Command value for valve output (Constant 1 byte)</p>	<p>Controller x Command value heating</p>	<p>The required constant command value of the chosen internal controller must be selected here. This makes it possible, depending on the application, to assign the valve output to available internal command values of the appropriate data format. The presetting of this parameter and the available selection of the settings is dependent on the configuration of the selected controller. A selection is then only possible with this parameter when the selected internal controller possesses constant command values.</p>
	<p>Controller x Command value basic level heating</p>	
	<p>Controller x Command value additional level heating</p>	
	<p>Controller x Command value basic level</p>	
	<p>Controller x Command value cooling</p>	
	<p>Controller x Command value basic level cooling</p>	
	<p>Controller x Command value additional level cooling</p>	
	<p>Controller x Command value additional level</p>	
<p>Controller x Command value cooling/heating</p>		

☐ Ax - Valve rinsing

Use function "Valve rinsing" ?

**no**  
**yes**

To prevent calcification or sticking of a valve which has not been activated for some time, the actuator has an automatic valve rinsing function. Valve rinsing can be executed cyclically or using a bus command, causing the activated valves to run through the full valve stroke for a preset period of time. During valve rinsing, the actuator activates a command value of 100 % without interruption for the affected valve output for half of the configured "Valve rinsing time". For this, the valves open completely. After half the time, the actuator switches to a command value of 0%, causing the connected valves to close completely. In the "Yes" setting, this parameter enables valve rinsing.

Length of valve rinsing (1...59 minutes)     **1...5...59**

Here, preset for how long the rinse function (100 % -> 0 %) is to be executed. Set the length of the valve rinsing to the adjustment cycle time of the electrothermal actuators in such a way that they open and close completely. This is usually guaranteed by configuring the rinsing length to double the adjustment cycle time. This parameter is only available if valve rinsing is enabled.

Activate cyclical valve rinsing ?

**yes**

The actuator can perform valve rinsing cyclically, if necessary. When using the cyclical valve rinsing, a rinse operation can be started automatically after a configurable cycle time (1...26 weeks). Here too, the valve rinsing length configured in the ETS defines the time for the once-only, complete opening and closing of the activated valve drives. At the end of a rinsing operation, the actuator always restarts the cycle time. This parameter is only available if valve rinsing is enabled.

Cyclical valve rinsing is enabled. Each ETS programming operation resets the cycle time. The first rinsing operation with cyclical valve rinsing takes place after an ETS programming operation after the first time cycle has elapsed. If there is a bus voltage failure, the actuator saves the remaining residual time of the current time cycle. The

		residual cycle time is restarted after bus voltage return. A bus voltage failure immediately interrupts an active rinsing operation. When the bus/mains voltage returns, a previously interrupted rinsing operation is not executed again. The actuator then starts a new time cycle for cyclical valve rinsing.
	no	Cyclical valve rinsing is completely disabled. Valve rinsing can only be started by the communication object (if enabled).
Cycle time (1...26 weeks)	1...26	This parameter defines how often cyclical valve rinsing is to be performed automatically. This parameter is only available if cyclical valve rinsing is enabled.
Use intelligent valve rinsing ?	no yes	Optionally, intelligent cyclical valve rinsing can be additionally activated here. Here, valve rinsing is only executed repeatedly, if, in the current time cycle, a configured minimum command value limiting value was not exceeded. If the active command value exceeds the limiting value, then the actuator will stop the cycle time. The actuator only restarts the cycle time if, in the further course of the command value change, a command value of "0 %" or "OFF" (completely closed) is set . This prevents valve rinsing if the valve has already run through a sufficiently defined stroke. If, after exceeding the configured limiting value, the value was not completely closed at least once (command value "0 %" or "OFF"), then no further cyclical valve rinsing will take place. This parameter is only available if cyclical valve rinsing is enabled.
Limiting value minimum command value (10...100 %)	10... <b>50</b> ...100	This parameter defines the minimum command value limiting value of the intelligent valve rinsing. Intelligent valve rinsing is only executed repeatedly, if, in the current time cycle, a minimum command value limiting value configured here was not exceeded. If the active command value exceeds the limiting value, then the actuator will stop the cycle time. This parameter is only available if cyclical valve rinsing is enabled.

<p>Valve rinsing activated externally ?</p>	<p><b>no</b> yes</p>	<p>If necessary, valve rinsing can be started and, optionally, stopped using its own 1-bit communication object. This means that it is possible to activate a rinsing operation of the valve controlled by time or an event. It is also possible, for example, to cascade multiple heating actuators, so that they perform valve rinsing simultaneously (link of the individual status objects to the input objects of the valve rinsing). Bus control can only be used if it has been enabled here. This parameter is only available if valve rinsing is enabled.</p>
<p>Polarity of object "Valve rinsing Start / Stop"</p>	<p><b>0 = Stop / 1 = Start</b>  0 = Start / 1 = Stop  0 = --- / 1 = Start (Stop not possible)</p>	<p>This parameter sets the telegram polarity of the object for external valve rinsing. The name of the object is aligned to the setting of the permitted telegram polarity ("Start / stop valve rinsing" or "Start valve rinsing"). When a start command is received, the actuator immediately starts the configured time for a rinsing operation. The actuator also actively executes valve rinsing if no higher-priority function is active. If bus-controlled stopping is permitted, then the actuator will also react to stop commands by immediately interrupting running rinsing operations.</p>
<p><input type="checkbox"/> Ax - Operating hours counter</p> <p>Use operating hours counter ?</p>	<p><b>no</b>  yes</p>	<p>The operating hours counter can be enabled here. The operating hours counter determines the switch-on time of a valve output. For the operating hours counter, an output is actively on, when it is energised, i.e. when the status LED on the front panel of the device. As a result, the operating hours counter determines the time during which deenergised closed valves are opened or deenergised opened valves are closed. If the operating hours counter is not enabled, no operating hours will be counted for the valve output concerned. Once the operating hours counter is enabled, however, the operating hours will be determined and added up by the ETS immediately after commissioning the actuator. If the operating hours counter is subsequently disabled again in the parameters and the actuator is programmed with this disabling function, all operating hours previously counted will be deleted. When enabled again, the</p>



		counter status of the operating hours counter is always on "0".
Type of counter	<b>Up-counter</b> Down-counter	The operating hours counter can be configured as an up-counter or down-counter. The setting here influences the visibility of the other parameters and objects of the operating hours counter.
Limiting value specification ?	<b>no</b> yes, as received via object yes, as specified in parameter	If the up-counter is used, a limiting value can optionally be predefined. This parameter defines whether the limiting value can be set via a separate parameter or adapted individually by a communication object from the bus. The "No" setting deactivates the limiting value. This parameter is only visible in the configuration "Up-counter" counter type.
Limit value (0...65535 h)	0... <b>65535</b>	The limiting value of the up-counter is set here. This parameter is only visible in the "Up-counter" counter type if the parameter "Limiting value presetting ?" is set to "Yes like the parameter".
Start value preset ?	<b>no</b> yes, as received via object yes, as specified in parameter	If the down-counter is used, a start value can optionally be predefined. This parameter defines whether the start value can be set via a separate parameter or adapted individually by a communication object from the bus. The setting "No" deactivates the start value. This parameter is only visible in the "Down-counter" counter type.
Start value (0...65535 h)	0... <b>65535</b>	The start value of the down-counter is set here. This parameter is only visible in the "Down-counter" counter type and also only if the parameter "Start value preset ?" is set to "Yes like the parameter".
Automatic transmitting of the counter value	  cyclical	The current counter status of the operating hours counter can be transmitted actively to the bus via the "value operating hours counter" communication object.  The counter status is transmitted cyclically to the bus and when there is a change. The cycle time is configured

		generally on the parameter page "General".
	<b>after change by interval value</b>	The counter status is transmitted to the bus only when there is a change.
Counting value interval (1...65535 h)	1... <b>65535</b>	The interval of the counter value is set here for automatic transmission. The current counter status is transmitted to the bus after the time value configured here. This parameter is only visible if the parameter "Automatic transmission of the number value" is set to "Change on interval value".
☐ Ax - Assignments		
Assignment to the function "Pump control" ?	<b>no</b> yes	The heating actuator allows switching activation of the circulation pump of a heating or cooling circuit via a 1-bit KNX telegram. Pump control is a global function of the heating actuator. It is enabled and configured on the "Valve / pump" parameter page. The parameter "Assignment to the function 'Pump control' ?" specifies whether the appropriate valve output is included in the pump control. The presetting of the parameter depends on the enabling function of the function. If pump control is not enabled on the "Valve / pump" parameter page, then the ETS will permanently set this parameter to "No". In this case, assignment is not possible. If pump control is enabled, this parameter is preset to "Yes".
Assignment to the "Heat requirement" function ?	<b>no</b> yes	The heating actuator can even evaluate the command values of its outputs and make general heat requirement available in the form of limiting value monitoring with hysteresis (1 bit, switching). Using a KNX switch actuator, this allows the energy-efficient activation of burner and boiler controllers with suitable control inputs (e.g. requirement-orientated switch-over between the reduction and comfort setpoint in a central combi boiler). The heat requirement control function is a global function of the heating actuator. It is enabled and configured on the "Valve / pump" parameter page. The parameter "Assignment to the 'Heat requirement' function ?" specifies whether the appropriate valve output is included in

<p>Assignment to the "Largest command value" function ?</p>	<p><b>no</b> <b>yes</b></p>	<p>the heat requirement control. The presetting of the parameter depends on the enabling function of the function. If the heat requirement function is not enabled on the "Valve / pump" parameter page, then the ETS will permanently set this parameter to "No". In this case, assignment is not possible. If the heat requirement function is enabled, this parameter is preset to "Yes".</p>
		<p>The actuator can determine the largest constant command value and forward it to another bus device (e.g. suitable calorific furnaces with integrated KNX control or visualisation). In the "Yes" setting, the heating actuator evaluates all the active 1-byte command values of the valve outputs and, optionally, the externally received largest command value (object "External largest command value") and transmits the largest command value via the "Largest command value" object. In the case of valve outputs configured in the ETS to the command value data formats "Switching (1-bit)" or "Constant (1-byte) with command value limiting value", there is no evaluation of the command values preset via the bus. Exception: It may also occur with such command value outputs that a constant command value is active (e.g. after bus/mains voltage return or a forced position and emergency operation or manual operation). In this case, this constant command value is also included in the calculation of the largest command value until the named functions with a higher priority are exited or a new command value telegram is received via the bus, overriding the constant command value at the valve output. The "Largest command value" function is a global function of the heating actuator. It is enabled and configured on the "Valve / pump" parameter page. The "Assignment to the 'Largest command value' function ?" parameter specifies whether the appropriate valve output is included in the evaluation of the largest command value. The presetting of the parameter depends on the enabling function of the function. If the "Largest command value" function is not enabled on the "Valve / pump" parameter page, then the ETS will permanently set this parameter to "No". In this case, assignment is not</p>



## 4.2.5.3 Parameters for room temperature controllers

Description	Values	Comment
<p>□ Room temperature control (RTCx) - RTCx - General</p>		
Name of the controller	20-character free text	The text entered in this parameter is used to label the controller in the ETS parameter window (e.g. "Controller kitchen", "Temperature bathroom"). The text is not programmed in the device.
Operating mode	<p><b>Heating</b></p> <p>Cooling</p> <p>Heating and cooling</p> <p>Basic and additional heating</p> <p>Basic and additional cooling</p> <p>Basic and additional heating and cooling</p>	<p>The room temperature controller distinguishes between two different operating modes. The operating modes specify whether you want the controller to use its variable to trigger heating systems ("heating" single operating mode) or cooling systems ("cooling" single operating mode). You can also activate mixed operation, with the controller being capable of changing over between "Heating" and "Cooling" either automatically or, alternatively, controlled by a communication object. In addition, you can establish two-level control operation to control an additional heating or cooling unit. For two-level feedback control, separate command values will be calculated as a function of the temperature deviation between the setpoint and the actual value and transmitted to the bus for the basic and additional levels.</p> <p>This parameter specifies the operating mode and, if necessary, enables the additional level(s).</p>
Transmit heating and cooling command values to one common object	yes no	<p>If the parameter is set to "Yes", the command value will be transmitted on a shared object during heating or cooling. This function is used, if the same heating system is used to cool the room in the summer and used to heat the room in the winter.</p> <p>This parameter is only visible with "heating and cooling" mixed operating mode, if applicable, with additional levels.</p>
Type of heating control (if applicable, for basic and additional stage)	<p><b>continuous PI control</b></p> <p>switching PI control (PWM)</p> <p>Switching 2-point feedback control (ON/OFF)</p>	<p>Selecting a feedback control algorithm (PI or 2-point) with data format (1-byte or 1-bit) for the heating system.</p>

Type of heating (if applicable, for basic and additional level)	<b>Hot water heater (5 K / 150 min)</b>	Adapting the PI algorithm to different heating systems using predefined values for the proportional range and reset time control parameters. With the "Using control parameters" setting, it is possible to set the control parameters in a manner deviating from the predefined values within specific limits. This parameter is only visible if "Type of heating control = Continuous PI control".
	Underfloor heating (5 K / 240 min)	
	Electric heating (4 K / 100 min)	
	Fan convector (4 K / 90 min)	
	Split unit (4 K / 90 min) via control parameter	
Proportional range heating (10 ... 127 x 0.1 K)	10... <b>50</b> ...127	Separate setting of the "Proportional range" control parameter. This parameter is only visible if "Type of heating = via control parameter" and the heating control type "PI control".
Reset time heating Minutes (0 = inactive) (0 ... 255)	0... <b>150</b> ...255	Separate setting of the "Reset time" control parameter. This parameter is only visible if "Type of heating = via control parameter" and the heating control type "PI control".
Top hysteresis of the 2-point controller heating (5 ... 127 x 0.1 K)	5...127	Definition of top hysteresis (switch-off temperatures) of the heating. This parameter is only visible if "Type of heating control = Switching 2-point feedback control (ON/OFF)".
Bottom hysteresis of the 2-point controller heating (-128 ... -5 x 0.1 K)	-128...-5	Definition of bottom hysteresis (switch-on temperatures) of the heating. This parameter is only visible if "Type of heating control = Switching 2-point feedback control (ON/OFF)".
Type of cooling control (if applicable, for basic and additional stage)	<b>continuous PI control</b> switching PI control (PWM)  Switching 2-point feedback control (ON/OFF)	Selecting a feedback control algorithm (PI or 2-point) with data format (1 byte or 1 bit) for the cooling system
Type of cooling (if applicable, for basic and additional level)	<b>Cooling ceiling (5 K / 240 min)</b>  Fan convector	Adapting the PI algorithm to different cooling systems using predefined values for the proportional range and reset time control parameters.

	(4 K / 90 min) Split unit (4 K / 90 min) via control parameter	With the "Using control parameters" setting, it is possible to set the control parameters in a manner deviating from the predefined values within specific limits. This parameter is only visible if "Type of cooling control = PI control".
Proportional range cooling (10 ... 127 x 0.1 K)	10... <b>50</b> ...127	Separate setting of the "Proportional range" control parameter. This parameter is only visible if "Type of cooling = via control parameter" and the cooling control type "PI control".
Reset time cooling Minutes (0 = inactive) (0 ... 255)	0... <b>150</b> ...255	Separate setting of the "Reset time" control parameter. This parameter is only visible if "Type of cooling = via control parameter" and the cooling control type "PI control".
Top hysteresis of the 2-point controller cooling (5 ... 127 x 0.1 K)	<b>5</b> ...127	Definition of top hysteresis (switch-on temperatures) of the cooling. This parameter is only visible if "Type of cooling control = Switching 2-point feedback control (ON/OFF)".
Cooling 2-point controller hysteresis lower limit (-128 ... -5 x 0.1 K)	-128... <b>-5</b>	Definition of bottom hysteresis (switch-off temperatures) of the cooling. This parameter is only visible if "Type of cooling control = Switching 2-point feedback control (ON/OFF)".
Additional stage inhibit object	yes <b>no</b>	The additional stages can be separately disabled via the bus. The parameter enables the disable object as necessary. This parameter is only visible in two-level heating and cooling operation.
Operating mode switch-over	<b>via value (1 byte)</b> via switching (4 x 1 bit)	In the setting "via value (1-byte)" the change-over of the operating modes via the bus takes place according to the KNX specification via a 1-byte value object. In addition, a higher-ranking forced object is available for this setting. In the setting "via switching (4 x 1 bit)" the 'classic' change-over of the operating modes via the bus is via four separate 1-bit objects.
Operating mode after reset	Restore operation mode before reset	This parameter specifies which operating mode is set immediately after

	<p>Comfort mode</p> <p><b>Standby mode</b></p> <p>Night operation</p> <p>Frost/heat protection mode</p>	<p>a device reset.</p> <p>With "Restore operation mode before reset": The mode set before a reset according to the operating mode object will be restored after the initializing phase of the device. Operating modes set by a function with a higher priority before the reset (Forced, Window status, Presence status) are not effected.</p>
<p>Change-over between heating and cooling</p>	<p><b>automatic</b></p> <p>via object (heating/cooling change-over)</p>	<p>In a configured mixed mode it is possible to switch over between heating and cooling.</p> <p>With "Automatic": Depending on the operating mode and the room temperature, the change-over takes place automatically.</p> <p>With "via object (heating/cooling change-over)": The change-over takes place only via the object "Heating/cooling change-over".</p> <p>With automatic setpoint presetting this parameter is permanently set to "Via object (heating/cooling change-over)"!</p>
<p>Heating / cooling mode after a reset</p>	<p><b>Heating</b></p> <p>Cooling</p> <p>Operating mode before reset</p>	<p>The preset operating mode for after a bus voltage return or an ETS programming operation is specified here.</p> <p>Only visible if "Change-over between heating and cooling = via object"!</p>
<p>Cyclical transmission heating/cooling change-over Minutes (0 = inactive) (0...255)</p>	<p><b>0...255</b></p>	<p>This parameter specifies whether the current object status of the "Heating / cooling change-over" object should be output cyclically to the bus on an automatic change-over. The cycle time can be set here. The "0" setting deactivates the periodic transmission of the object value.</p> <p>Only visible if "Change-over between heating and cooling = automatic".</p>
<p>Frost/heat protection</p>	<p>Automatic frost protection</p> <p><b>via window status</b></p>	<p>Here it is possible to determine how the room temperature regulator switches into the frost/heat protection.</p> <p>With "automatic frost protection": the automatic frost protection is activated. Depending on the room temperature this allows an automatic switch-over into the frost protection mode.</p> <p>With "Via window status": switch-over into the frost/heat protection takes place via the "window status" object.</p>



<p>Automatic frost protection temperature drop</p>	<p><b>Off</b> 0.2 K / min. 0.3 K / min. 0.4 K / min. 0.5 K / min. 0.6 K / min.</p>	<p>This parameter determines the decrease temperature by which the room temperature has to decrease within one minute in order for the controller to switch into the frost protection mode. The "OFF" setting will deactivate the frost protection automatic. Only visible if "frost/heat protection = Automatic frost protection"!</p>
<p>Frost protection period in automatic mode (1...255) * 1 min</p>	<p>1...<b>20</b>...255</p>	<p>The length of the automatic frost protection is defined here. After the preset time has elapsed, the controller will return to the operating mode which was set before frost protection. Re-triggering will not be possible. Only visible if "frost/heat protection = Automatic frost protection"!</p>
<p>Window status delay Minutes (0 = inactive) (0...255)</p>	<p><b>0</b>...255</p>	<p>This parameter defines the delay time for the window status. After the parameterised time has elapsed after the window is opened the window status will be changed and thus the frost/heat protection mode activated. Such delay can make sense if short ventilation of the room by opening the window is not supposed to change the operating mode. Only visible if "Frost/heat protection = via window status"!</p>
<p>☐ Room temperature control (RTCx) - RTCx - General</p>		
<p>Temperature detection of the room temperature controller through</p>	<p><b>External temperature value 1</b>  External temperature values 1 + 2</p>	<p>The controller detects the room temperatures using one or possibly two external KNX temperature sensors (e.g. push-button sensors with temperature measurement). Depending on the configuration, the 2-byte objects "Received temperature 1 (temperature sensor 1)" and, optionally, "Received temperature 2 (temperature sensor 2)" are enabled. After a device reset, the controller will first wait for valid temperature telegrams to both objects until control starts and a command value, if applicable, is output.</p> <p>Setting "External temperature value 1": The actual temperature is determined solely via an external temperature value. In this case, the KNX temperature sensor is connected to the controller via the 2-byte object "Received temperature 1 (Temperature sensor 1)".</p>

		Setting "External temperature values 1 + 2": The actual temperature is determined using two external temperature values. The selected temperature sources are combined. In this case, the KNX temperature sensors are connected to the controller via the two 2-byte objects "Received temperature 1 (Temperature sensor 1)" and "Received temperature 2 (Temperature sensor 2)".
Calibration of temperature value 1 (-128...127 x 0.1 K)	-128... <b>0</b> ...127	Specifies the value by which the room temperature measured value of the first external KNX temperature sensor is calibrated.
Calibration of received temperature value (-128...127 x 0.1 K)	-128... <b>0</b> ...12	Specifies the value by which the room temperature measured value of the second external KNX temperature sensor is calibrated. This parameter is only visible when the temperature detection system requires two external temperature sensors.
Measured value formation Temperature value 1 to temperature value 2	10% to 90% 20% to 80% 30% to 70% 40% to 60% <b>50% to 50%</b> 60% to 40% 70% to 30% 80% to 20% 90% to 10%	The weighting of the temperature values of the two external KNX temperature sensors is specified here. That results in an overall value, which will be used for the further interpretation of the room temperature. This parameter is only visible when the temperature detection system requires two external temperature sensors.
Polling time for temperature value Minutes (0 = inactive) (0...255)	<b>0</b> ...255	The polling time for the external temperature value is specified here. In the "0" setting, the temperature value is not automatically polled by the controller. In this case the communication partner (e.g. controller extension) must transmit its temperature value itself. This parameter is only visible when the temperature detection system requires only one temperature sensor.
Polling time, temperature values Minutes (0 = inactive) (0...255)	<b>0</b> ...255	The polling time for both external temperature values is specified here. In the "0" setting, the temperature values are not automatically polled by the controller. In this case, the communication partners (e.g. controller

		extensions) must transmit their temperature value themselves. This parameter is only visible when the temperature detection system requires two external temperature sensors.
Transmission when room temperature change by (0 = inactive) (0..255 x 0.1 K)	0... <b>3</b> ...255	This parameter specifies the temperature value by which the actual value has to change in order to have the actual temperature value transmitted automatically via the object. The "0" setting deactivates the automatic transmission of the actual temperature.
Cyclical transmission of room temperature Minutes (0 = inactive) (0...255)	0... <b>15</b> ...255	This parameter specifies whether and when the determined room temperature is output cyclically via the "Actual temperature" object.
<input type="checkbox"/> Room temperature control (RTCx) - RTCx - General		
Overwrite setpoint in device during ETS programming operation?	<b>yes</b> no	The setpoint temperatures programmed in the room temperature controller by the ETS during commissioning can be changed via communication objects. This parameter can be used to define whether the setpoints present in the device, which may have been changed subsequently, are overwritten during an ETS programming operation and thus replaced again by the values parameterised in the ETS. If this parameter is "Yes", then the setpoint temperatures are deleted in the device during a programming operation and replaced by the values of the ETS. If this parameter is configured to "No", then setpoints present in the device remain unchanged. The setpoint temperatures entered in the ETS then have no significance.
Setpoint presetting	<b>relative (setpoint temperatures from basic setpoint)</b>  absolute (independent setpoint temperatures)	It is possible to configure the setpoints for the "Comfort", "Standby" and "Night" modes directly (absolute setpoint presetting) or relatively (derivation from basic setpoint). This parameter defines the way the setpoint temperature is preset. With "Relative": All temperature setpoints are derived from the basic temperature (basic setpoint). With "Absolute": The setpoint temperatures are independent of each other. Different temperature values can be specified for each operating mode

and heating/cooling mode.

Basic temperature after reset  
(7.0 ... 40.0 °C) **21.0**

This parameter defines the temperature value to be applied as the basic setpoint after commissioning by the ETS. All the temperature setpoints are derived from the basic setpoint.  
This parameter is only visible with relative setpoint presetting!

Permanently apply change to basic setpoint shift **yes**  
**no**

In addition to specifying individual setpoint temperatures by the ETS or basic setpoint object, the user can shift the basic setpoint in a specific range via a communication object. Whether a basic setpoint shifting only affects the currently active operating mode or whether it influences all other setpoint temperatures of the remaining operating modes is determined by this parameter.

In the "yes" setting, the shift of the basic setpoint carried out affects all operating modes. The shift is maintained even after a switchover of the operating mode or the heating/cooling mode or adjusting the basic setpoint.

In the "no" setting, the basic setpoint shift carried out is in effect for only as long as the operating mode or heating/cooling mode has not changed or the basic setpoint is maintained. Otherwise the setpoint shift will be reset to "0".

This parameter is only visible with relative setpoint presetting!

Changing the setpoint of the basic temperature **deactivated**  
**approve via bus**

Here, it is possible to specify if it is possible to change the basic setpoint via the bus.

This parameter is only visible with relative setpoint presetting!

Permanently apply change to basic temperature setpoint? **yes**  
**no**

One has to distinguish between two cases, defined by this parameter, if the basic setpoint has been modified via the object. This parameter is only visible with relative setpoint presetting!

When "yes": If, with this setting, the setpoint temperature is adjusted, the controller saves the value permanently to the permanent storage. The newly adjusted value will overwrite the initial

Dead band position	<p>symmetrical <b>asymmetrical</b></p>	<p>value, i.e. the basic temperature originally configured via the ETS after a reset! The changed values are also retained after a device reset, after a switchover of the operating mode or after a switchover of the heating/cooling mode.</p> <p>When "no": The setpoints set on the room temperature controller or received via the objects remain active only temporarily. In case of a bus voltage failure, after a switchover to another operating mode (e.g. Comfort to Standby, or also Comfort to Comfort), or after a switchover of the heating/cooling mode (e.g. Heating to Cooling), the last setpoint changed will be discarded and replaced by the initial value.</p>
<p>Deadband between heating and cooling (0...127) x 0.1 K</p>	<p>0...<b>20</b>...127</p>	<p>With relative setpoint presetting, the comfort setpoint temperatures for the operating mode "Heating and cooling" are derived from the basic setpoint in consideration of the adjusted Dead band. The deadband (temperature zone for which there is neither heating nor cooling) is the difference between the comfort setpoint temperatures.</p> <p>Symmetrical setting: the deadband preset in the ETS plug-in is divided in two parts at the basic setpoint. The comfort setpoint temperatures are derived directly from the basic setpoint resulting from the half deadband (Basic setpoint - 1/2 deadband = Heating comfort temperature or Basic setpoint + 1/2 deadband = Cooling comfort temperature).</p> <p>Asymmetrical setting: with this setting the comfort setpoint temperature for heating equals the basic setpoint! The preset deadband is effective only from the basic setpoint in the direction of comfort temperature for cooling. Thus the comfort set-temperature for cooling is derived directly from the comfort setpoint for heating.</p> <p>The parameter is only visible in the "Heating and cooling" operating mode (if necessary with additional levels) and only with relative setpoint presetting!</p> <p>With relative setpoint presetting, the comfort setpoint temperatures for heating and cooling are derived from the basic setpoint in consideration of the adjusted Dead band. The deadband (temperature zone for which there is</p>

		neither heating nor cooling) is the difference between the comfort setpoint temperatures. It is set using this parameter. The parameter is only visible in the "Heating and cooling" operating mode (if necessary with additional levels) and only with relative setpoint presetting!
Setpoint temp. comfort mode (heating) (7.0 °C...40.0 °C)	<b>21.0</b>	With absolute setpoint presetting the setpoint temperatures for comfort, standby and night mode are independent of each other. Depending on the operating mode and heating/cooling mode, various temperature values can be specified in the ETS within the range +7.0 °C to +40.0 °C. The ETS does not validate the temperature values. It is thus possible, for example, to select smaller setpoint temperatures for cooling mode than for heating mode, or to specify lower temperatures for comfort mode than for standby mode. After commissioning using the ETS the setpoint temperatures can be changed via the bus by means of temperature telegrams. This can be done using the communication object "Setpoint active operating mode". Presetting of the setpoint temperature for the comfort heating mode. These parameters are only visible with absolute setpoint presetting!
Setpoint temp. standby mode (heating) (7.0 °C...40.0 °C)	<b>19.0</b>	Presetting of the setpoint temperature for standby mode (heating).
Setpoint temp. night mode (heating) (7.0 °C...40.0 °C)	<b>17.0</b>	Presetting of the setpoint temperature for night mode (heating).
Setpoint temp. comfort mode (cooling) (7.0 °C...40.0 °C)	<b>23.0</b>	Presetting of the setpoint temperature for standby mode (cooling).
Setpoint temp. standby mode (cooling) (7.0 °C...40.0 °C)	<b>25.0</b>	Presetting of the setpoint temperature for standby mode (cooling).
Setpoint temp. night mode (cooling) (7.0 °C...40.0 °C)	<b>27.0</b>	Presetting of the setpoint temperature for night mode (cooling).



Lower the setpoint temperature during standby operating mode (heating) (-128...0 x 0.1 K)	-128... <b>-20</b> ...0	The value by which the standby setpoint temperature for heating is lowered compared to the heating comfort temperature. The parameter is only visible in the "Heating" or "Heating and cooling" operating mode (if necessary with additional levels) and only with relative setpoint presetting.
Lower the setpoint temperature during Night mode (heating) (-128...0 x 0.1 K)	-128... <b>-40</b> ...0	The value by which the night setpoint temperature for heating is lowered compared to the heating comfort temperature. The parameter is only visible in the "Heating" or "Heating and cooling" operating mode (if necessary with additional levels) and only with relative setpoint presetting.
Raise the setpoint temperature during standby operating mode (cooling) (0...127 x 0.1 K)	0... <b>20</b> ...127	The value by which the standby setpoint temperature for cooling is lowered compared to the cooling comfort temperature. The parameter is only visible in the "Heating" or "Heating and cooling" operating mode (if necessary with additional levels) and only with relative setpoint presetting.
Raise the setpoint temperature during Night mode (cooling) (0...127 x 0.1 K)	0... <b>40</b> ...127	The value by which the night temperature for cooling is lowered compared to the cooling comfort temperature. The parameter is only visible in the "Heating" or "Heating and cooling" operating mode (if necessary with additional levels) and only with relative setpoint presetting.
Difference between basic and additional levels (0...127 x 0.1 K)	0... <b>20</b> ...127	In a two stage control mode it is necessary to determine the temperature difference to the basic stage with which the additional stage is to be incorporated into the control. This parameter defines the level spacing. The parameter can only be seen in two-level control operation.
Step width of the setpoint shift	0.1 K <b>0.5 K</b>	This parameter defines the value of a level of the setpoint shift. With a setpoint shift, the basic setpoint (with relative setpoint specification) is changed by the temperature value configured here when



		there is an adjustment by one step in a positive or negative direction. The controller module rounds the temperature values received via the "Basic Setpoint" object and matches the values to the step width configured here.
Frost protection setpoint temperature (7.0...40.0 °C)	<b>7.0</b>	This parameter specifies the setpoint temperature for frost protection. The parameter is only visible in "Heating" or "Heating and cooling" operating modes (if necessary with additional levels).
Heat protection setpoint temperature (7.0...45.0 °C)	<b>35.0</b>	This parameter specifies the setpoint temperature for heat protection. The parameter is only visible in "Cooling" or "Heating and cooling" operating modes (if necessary with additional levels).
Transmission at setpoint temperature change by (0...255 x 0.1 K)	<b>0...1...255</b>	Determines the size of the value change required to automatically transmit the current value via the "Setpoint temperature" object. In the "0" setting, the setpoint temperature is not transmitted automatically when there is a change.
Cyclical transmission of setpoint temperature Minutes (0 = inactive) (0...255)	<b>0...255</b>	This parameter determines whether the setpoint temperature is to be transmitted periodically via the "Setpoint temperature" object. Definition of the cycle time by this parameter In the "0" setting, the setpoint temperature is not transmitted automatically cyclically.
Setpoint temperature limit in cooling operation	<b>No limit</b> Only difference to outdoor temperature Only max. setpoint temperature Max. setpoint and difference to outdoor temperature	Optionally, the setpoint temperature limit can be enabled here, which is only effective in cooling operation. If necessary, the controller limits the setpoint temperature to specific values and prevents an adjustment beyond the limits.  "Only difference to outdoor temperature" setting, the outdoor temperature is monitored and compared to the active setpoint temperature in this setting. The specification of the maximum temperature difference to the outdoor temperature is made using the "Difference to outdoor temperature in cooling mode" parameter. If the outdoor temperature rises above 32 °C, then the controller activates the setpoint



		temperature limit" ("1" telegram). If the limitation is not enabled ("0" telegram), the cooling setpoint temperatures are not limited. This parameter is visible only if setpoint temperature monitoring is enabled.
Difference to outdoor temperature in cooling operation (1...15 K)	1 K... <b>6 K</b> ...15 K	This parameter defines the maximum difference between the setpoint temperature in Comfort mode and the outdoor temperature with an active setpoint temperature limit. This parameter is visible only if setpoint temperature monitoring is enabled. However, this is only if the parameter "Setpoint temperature limit in cooling operation" is then set to "Only difference to outdoor temperature" or "Max. setpoint temperature and difference to outdoor temperature".
Maximum setpoint temperature in cooling operation	20°C... <b>26°C</b> ...35°C	This parameter defines the maximum setpoint temperature in Comfort mode with an active setpoint temperature limit. This parameter is visible only if setpoint temperature monitoring is enabled. However, this is only if the parameter "Setpoint temperature limit in cooling operation" is then set to "Only max. setpoint temperature" or "Max. setpoint temperature and difference to outdoor temperature".
<input type="checkbox"/> Room temperature control (RTCx) - RTCx - General		
Automatic transmission at modification by (0 = inactive) (0...100 %)	0... <b>3</b> ...100	This parameter determines the size of the command value change that will automatically transmit continuous command value telegrams via the command value objects. Thus this parameter only affects command values which are configured to "Continuous PI control" and to the 1 byte additional command value objects of the "Switching PI control (PWM)".
Cycle time of the switching command value (Minutes) (1...255)	1... <b>15</b> ...255	This parameter specifies the cycle time for the pulse width modulated command value (PWM). Thus this parameter only affects command values which are configured to "Switching PI control (PWM)".
Cycle time for automatic transmission	0... <b>10</b> ...255	This parameter determines the time interval for the cyclical transmission of

(0 = inactive) (0...255)		the command values via all command value objects.
Output of the heating variable	<p>inverted (under current, this means closed)</p> <p><b>normal (under current, this means opened)</b></p>	<p>At this point, it is possible to specify whether the command value telegram for heating is output normally or in inverted form.</p> <p>This parameter is only visible if the operating mode "Heating" or "Heating and cooling" is configured and not two-level operation.</p>
Output of the command value basic level heating	<p>inverted (under current, this means closed)</p> <p><b>normal (under current, this means opened)</b></p>	<p>At this point, it is possible to specify whether the command value telegram for the heating basic level is output normally or in inverted form.</p> <p>This parameter is only visible if the operating mode "Heating" or "Heating and cooling" is configured along with two-level operation.</p>
Output of the heating additional stage variable	<p>inverted (under current, this means closed)</p> <p><b>normal (under current, this means opened)</b></p>	<p>At this point, it is possible to specify whether the command value telegram for the heating additional level is output normally or in inverted form.</p> <p>This parameter is only visible if the operating mode "Heating" or "Heating and cooling" is configured along with two-level operation.</p>
Output of the cooling variable	<p>inverted (under current, this means closed)</p> <p><b>normal (under current, this means opened)</b></p>	<p>At this point, it is possible to specify whether the command value telegram for cooling is output normally or in inverted form.</p> <p>This parameter is only visible if the operating mode "Cooling" or "Heating and cooling" is configured and not two-level operation.</p>
Output of the command value basic level cooling	<p>inverted (under current, this means closed)</p> <p><b>normal (under current, this means opened)</b></p>	<p>At this point, it is possible to specify whether the command value telegram for the cooling basic level is output normally or in inverted form.</p> <p>This parameter is only visible if the operating mode "Cooling" or "Heating and cooling" is configured along with two-level operation.</p>
Output of the cooling additional stage variable	<p>inverted (under current, this means closed)</p> <p><b>normal (under current, this means opened)</b></p>	<p>At this point, it is possible to specify whether the command value telegram for the cooling additional level is output normally or in inverted form.</p> <p>This parameter is only visible if the</p>

		operating mode "Cooling" or "Heating and cooling" is configured along with two-level operation.
Heating indication	yes no	Depending on the set operating mode, a separate object can be used to signal whether the controller is currently demanding heating energy and is thus actively heating. The "Yes" setting here enables the message function for heating.
Cooling indication	yes no	Depending on the set operating mode, a separate object can be used to signal whether the controller is currently demanding cooling energy and is thus actively cooling. The "Yes" setting here enables the message function for cooling.
Command value limit	<b>deactivated</b> continuously activated can be activated via object	The command value limit allows the restriction of calculated command values to the range limits "minimum" and "maximum". The limits are permanently set in the ETS and, if command value limitation is active, can be neither undershot or exceeded during device operation. The "Command value limit" parameter defines the mode of action of the limiting function. The command value limit can either be activated or deactivated using the 1-bit communication object "Command value limit", or be permanently active.
Command value limit after reset	<b>deactivated</b> activated	When controlling via the object, it is possible to have the controller activate the command value limit automatically after bus voltage return or an ETS programming operation. This parameter defines the initialisation behaviour here. In the "Deactivated" setting, the command value limit is not automatically activated after a device reset. A "1" telegram must first be received via the "Command value limit" object for the limit to be activated. In the "Activated" setting, the controller activates the command value limit automatically after a device reset. To deactivate the limit a "0" telegram must be received via the "Command value limit" object. The limit can be switched on or off at any time using the object. This parameter is only visible with

"Command value limit = can be activated via object!"

<p>Minimum command value for heating (optionally also for basic and additional level)</p>	<p><b>5%</b>, 10%, 15%, 20%, 25%, 30%, 35%, 40%, 45%, 50%</p>	<p>The "Minimum command value" parameter specifies the lower command value limiting value for heating. With an active command value limit, the set minimum command value is not undershot by command values. If the controller calculates smaller command values, it sets the configured minimum command value. The controller transmits a 0 % command value if no more heating or cooling energy has to be demanded.</p>
<p>Maximum command value for heating (optionally also for basic and additional level)</p>	<p>55%, 60%, 65%, 70%, 75%, 80%, 85%, 90%, <b>95%</b>, 100%</p>	<p>The "Maximum command value" parameter specifies the upper command value limiting value for heating. With an active command value limit, the set maximum command value is not exceeded. If the controller calculates larger command values, it sets the configured maximum command value.</p>
<p>Minimum command value for cooling (optionally also for basic and additional level)</p>	<p><b>5%</b>, 10%, 15%, 20%, 25%, 30%, 35%, 40%, 45%, 50%</p>	<p>The "Minimum command value" parameter specifies the lower command value limiting value for cooling. With an active command value limit, the set minimum command value is not undershot by command values. If the controller calculates smaller command values, it sets the configured minimum command value. The controller transmits a 0 % command value if no more heating or cooling energy has to be demanded.</p>
<p>Maximum command value for cooling (optionally also for basic and additional level)</p>	<p>55%, 60%, 65%, 70%, 75%, 80%, 85%, 90%, <b>95%</b>, 100%</p>	<p>The "Maximum command value" parameter specifies the upper command value limiting value for cooling. With an active command value limit, the set maximum command value is not exceeded. If the controller calculates larger command values, it sets the configured maximum command value.</p>
<p>Controller status</p>	<p><b>no status</b>  KNX compliant  Controller general  transmit individual state</p>	<p>The room temperature controller can transmit its current status to the KNX. A choice of data formats is available for this. This parameter enables the status signal and sets the status format.</p>

Single status	<p><b>Comfort operation activated</b></p> <p>Standby mode activated</p> <p>Night mode activated</p> <p>Frost/heat protection active</p> <p>Controller disabled</p> <p>Heating / cooling</p> <p>Controller inactive</p> <p>Frost alarm</p>	<p>Here, the status information is defined which is to be transmitted onto the bus as the 1-bit controller status.</p> <p>This parameter is only visible if the parameter "Controller status" is set to "Transmit single status".</p>
<p>☐ Room temperature control (RTCx) - RTCx - General</p>		
Presence detection	<p>none</p> <p><b>Presence button</b></p> <p>Presence detector</p>	<p>In the "None" setting, the presence mode is deactivated.</p> <p>In the "Presence button" setting, presence detection takes place using the "Presence button" object (e.g. other push-button sensors). When the presence button is pressed from the night mode or frost/heat protection, the comfort extension is activated. If the presence button is pressing in standby mode, the controller activates the comfort mode for the duration of the presence mode.</p> <p>In the "Presence detector" setting, presence detection takes place using an external presence detector, coupled to the "Presence detector" object. Comfort mode is recalled when a presence is detected. Comfort mode remains active until the presence detector ceases to detect movement.</p>
<p>Length of the comfort extension Minutes (0 = OFF) (0 .. 255)</p>	<p>0...<b>30</b>...255</p>	<p>When the presence button is pressed from the Night mode or Frost/heat protection, the controller switches to Comfort mode for the length of time specified here. When this time has elapsed, it switches back automatically. In the "0" setting, the comfort extension is switched off, meaning that it cannot be activated from Night or Frost/heat protection mode. In this case, the operating mode will not be changed, although the presence function has been activated.</p> <p>This parameter is only visible when presence detection is configured to "Presence button".</p>

Switch off controller (dew point operation)	<b>no</b> via bus	This parameter enables the "Disable controller" object. If the controller is disabled, there is no feedback control until enabled (command values = 0).
Underfloor heating temperature limit	<b>not present</b> present	The temperature limit can be activated in the controller in order to protect an underfloor heating system. If the temperature limit is enabled here ("Present" setting), the controller continuously monitors the floor temperature. Should the floor temperature exceed a specific limiting value on heating, the controller switches the command value off immediately, thus switching the heating off and cooling the system. Only when the temperature falls below the limiting value, minus a hysteresis of 1 K, will the controller add the most recently calculated command value. The floor temperature is fed to the controller using a separate object. It should be noted that the temperature limit only affects command values for heating. Thus, the temperature limit requires the controller operating modes "Heating" or "Heating and cooling".
Effect on	<b>Heating, basic level</b> Heating, additional level	The temperature limit can also be used in a two-level feedback control with basic and additional levels. It must then be specified here to which level the limit shall apply. Either the basic level or to the additional level for heating can be limited. This parameter can only be set in two-level control operation.
Maximum temperature, underfloor heating (20...70 °C)	20... <b>30</b> ...70	The maximum limit temperature which the underfloor heating system may reach is specified here. If this temperature is exceeded, the controller switches the underfloor heating system off using the command value. As soon as the floor temperature has fallen 1 K under the limit temperature, the controller switches the command value on again, assuming that this is intended in the control algorithm.
Hysteresis of limit temperature	<b>1 K</b>	The hysteresis of the floor temperature limit is fixed to "1 K" and cannot be



changed.

## 5 Appendix

### 5.1 Index

#### Numerical

2-point feedback control..... 127,133

#### A

Accept setpoints permanently..... 154  
 actual temperature..... 144  
 Adapting..... 131,133  
 anti-sticking protection..... 75  
 as-delivered state..... 168  
 automatic frost protection..... 140

#### B

Basic setpoint shift..... 155

#### C

Calibrating..... 143  
 Clipping..... 164  
 Collective feedback..... 64  
 Combined valve status..... 104  
 Comfort extension..... 139  
 Command value limit..... 160  
 Command value objects..... 159  
 Command value status..... 101  
 control algorithm..... 124  
 Controller status..... 162  
 cycle time..... 91

#### D

dew point mode..... 165

#### E

ETS search paths..... 22

#### F

First Open function..... 16

#### H

Heat requirement control..... 69  
 Heating/cooling message..... 123

#### I

intelligent valve rinsing..... 115

#### L

Largest command value..... 71

#### M

measured value formation..... 142

mixed operating mode..... 122

#### O

operating hours counter..... 117  
 operating mode after a reset..... 141  
 Operating mode switchover..... 135  
 operating modes..... 121  
 overload..... 107

#### P

PI control..... 125,131  
 Presence function..... 139  
 pump controller..... 74

#### S

Safe-state mode..... 25  
 Service mode..... 61  
 setpoint temperature limit..... 156  
 Setpoint temperature presetting..... 145  
 Setpoint temperatures..... 146  
 short-circuit..... 107  
 Short-circuit / overload display..... 15  
 single operating modes..... 121  
 Status indication..... 15  
 Switching PI control..... 125

#### T

Temperature detection..... 142  
 temperature limit..... 166  
 Testing cycle..... 107

#### V

valve direction of action..... 81  
 valve rinsing function..... 113

#### W

window status..... 140

**Gira**  
**Giersiepen GmbH & Co. KG**  
Elektro-Installations-  
Systeme

Industriegebiet Mermbach  
Dahlienstraße  
42477 Radevormwald

Postfach 12 20  
42461 Radevormwald

Deutschland

Tel +49(0)21 95 - 602-0  
Fax +49(0)21 95 - 602-191

[www.gira.de](http://www.gira.de)  
[info@gira.de](mailto:info@gira.de)