



Operating instructions

1 Safety instructions



Electrical devices may only be mounted and connected by electrically skilled persons.

Serious injuries, fire or property damage possible. Please read and follow manual fully.

Danger of electric shock. Always disconnect before carrying out work on the device or load. In so doing, take all the circuit breakers into account, which support dangerous voltages to the device and or load.

Do not operate the screen with sharp or pointed objects. The touch-sensitive surface could be damaged.

Do not use sharp objects for cleaning. Do not use sharp cleaning agents, acids or organic solvents.

These instructions are an integral part of the product, and must remain with the end customer.

2 Device components

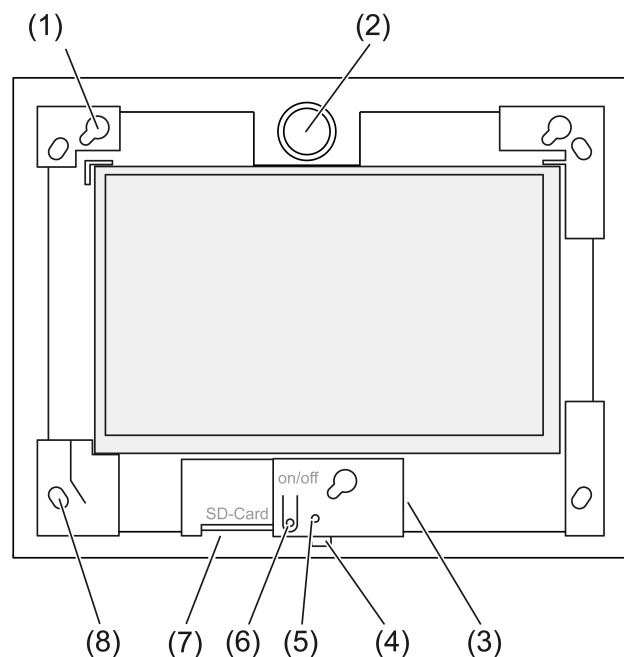

Figure 1: Front view without Design frame

- (1) Bracket for Design frame
- (2) Loudspeaker
- (3) USB connection
- (4) Microphone
- (5) Status LED
- (6) On/off push-button
- (7) Slot for SD memory card
- (8) Holes for wall fastening

3 Function

Intended use

- Visualisation of system statuses and information on building automation in conjunction with Gira Software (TKS Communicator, QuadClient, HomeServer HS Client).
- Flush mounting in indoor areas in a Control 9 panel-mounted housing (see Accessories chapter), or with adapter frame in panel-mounted housing for information terminal.

Unsuitable applications are for example:

- Operation in safety-relevant areas.
- Operation outdoors.
- Operation in non-stationary environment (e. g. on a yacht, in a mobile home, etc.).
- Operation in direct sunlight exposure.
- Operation in ambient condition that do not comply with specifications with regard to temperature, humidity, dust, vibration, etc.
- Operation in aggressive ambient conditions, e. g. swimming pools, sauna areas, etc.
- Operation outside the brightness setting operating modes set at the factory (normal, extended, presentation).
- Operation without design frame.

i Proper function can only be guaranteed with the use of the specified software products. Gira cannot provide service or guarantees for software products from third-party manufacturers.

Product characteristics

- Graphic colour screen TFT, 1024×600 pixel, 16.7 million colours.
- Capacitive multi-touchscreen, operation via touch directly on the screen.
- Operating system: Microsoft Windows embedded POSReady 7.
- Fitting position horizontal.
- Without fan, low-noise.
- Integrated loudspeaker.
- Integrated microphone.
- Interfaces - from, behind Design frame: USB, SD memory card.
- Interfaces – accessible from rear: 2x USB, Ethernet, Stereo Audio-In, Stereo Audio-Out.

Operating system

The operating system Microsoft® Windows® embedded POSReady 7 x86 (32 Bit) is based on Microsoft® Windows® 7 in a memory-optimised version. All the components required for the device function are preinstalled. Additional drivers or programs, e.g. Gira software pack QuadClient, can be installed at a later time.

i The Microsoft® Windows® licence is located on the rear side of the device.

4 Operation

Cleaning the touchscreen

The touchscreen requires regular cleaning in order to guarantee the optimum touch sensitivity. Keep the screen free of foreign bodies and dust. Use a soft, lint-free cloth to clean the screen. If needed, moisten the cleaning cloth slightly.

i Do not use sharp cleaning agents, acids or organic solvents.

i Keep moisture from penetrating into the device. Do not spray the cleaning agent directly onto the screen surface.

i Do not use sharp objects for cleaning.

Removing the Design frame

Certain operating elements are only accessible when the Design frame has been removed.

- Hold the bottom of the Design frame with both hands.
- Carefully push the Design frame upwards to the right.
- When the Design frame is loose in the bracket, pull it carefully away from the wall.

Mounting the Design frame

- i** Observe top/bottom installation orientation! The loudspeaker can be damaged if handled incorrectly!
- Insert the Design frame into the brackets (1) in the right position.
- Carefully push the Design frame downwards left until it engages.

Switching a device on or off

The On/off push-button (6) can be reached when the Design frame has been removed.

- Switching on: Press the push-button (6).
The device switches on after about 2 seconds.
- i** The device executes a check script at each system start. This is visible in a command prompt. After a successful check with a green message text, the prompt window is automatically closed. In the event of an error, the message text appears in red. The system must then be set up again.
- If a message about activating write protection appears after rebooting the operating system:
To continue with already started installation work that requires deactivated write protection: select **Abbruch** .
To edit the device with the installed software packs: select **OK** .
- Switching off: select the "Shut Down" command in the Start menu.
- Shut down the device in idle state: press the push-button (6).
- i** After appropriate setup, switching off can also be done with the push-button (6).
- i** When the device is in idle state, functionality is immediately reactivated when operating the touchscreen. After the wake-up from idle state the password must be entered.
- i** When delivered, the device logs in automatically when switching on with the username **Control** and the password **gira** .

Perform restart

If the device can no longer be operated, it can be defined as powered down and switched off.

- i** Caution! When doing a restart ("Reset") any unsaved data will be lost. In extreme cases, configuration data can also be affected and the system must be restored.

The On/off push-button (6) can be reached when the Design frame has been removed.

- Press the push-button (6) for approx. 10 seconds.
The device switches off after about 10 seconds.

Operation using gestures

The device is operated by touching the screen surface with a finger, which controls the cursor on the screen.

- i** Do not operate the screen with sharp or pointed objects.

Standard Windows 7 gestures are used for operation:

- Left click: tap.
- Left double-click: double tap.
- Drag/select with the mouse: swipe left or right with a finger.
- Right click: in order to right click, press with a finger on the target and tap with a second finger.
Alternatively touch the target point with a finger for more than 3 seconds. Depending on the installed software, this gestures can be disabled in order to avoid conflicts with other functions (e. g. dimming).

Text can be input using the Windows on-screen keyboard. This is appears instantly when tapping in an input field.

The "Gira cursor" function optimises device operation requiring long screen touching, e.g. for dimming or moving Venetian blinds.

The "Gira cursor" function is activated as follows:

- Double tap the "Gira cursor" icon.
The "Gira cursor" function is activated.
The device restarts.
The "Gira cursor" function is activated.
- i** You can switch at any time between the "Standard cursor" and "Gira cursor" functions. The "Standard cursor" function is activated at the factory.
- i** Additional operating devices, such as a keyboard or a mouse, can be connected to the USB interface.

Setting screen brightness

The brightness setting for the screen can be accessed in the information area of the Windows taskbar using the 3 icon.

- i** The icon 3 display can be manually activated if it is not visible in the information area of the taskbar (see chapter Commissioning ▶ Page 9).

In addition to the option of adjusting the brightness with the slider on the desktop, the device has three operating modes for brightness. The active operating mode is indicated by a check mark.

- Normal operating mode:
In normal operating mode a wrench symbol appears at the top left. Touching or clicking the symbol brings you to a submenu where the coordinated dimming and switch-off times can be individually adjusted. The dimming time is part of the switch-off time.
The following values are set depending on the position of the slider on the scale and confirmed with OK.

Dimming time	Switch-off time
3 minutes	15 minutes
2 minutes	10 minutes
1 minutes	5 minutes
30 seconds.	3 minutes
20 seconds.	2 minutes
15 seconds.	1 minute
10 seconds.	30 seconds.
5 seconds.	15 seconds.

- Operating mode expanded:
The screen automatically dims after 3 minutes. The screen does not switch off.
- Operating mode presentation:
The screen is not automatically dimmed or switched off. The brightness is adjusted to allow a maximum brightness of 50 %.

File-based write filter

The device contains an M.2-SSD drive as a mass storage facility. To prevent accidental changes to the configuration, the drive is set up with write protection. Write operations to the protected area are diverted to a virtual drive. Changes to this data are shown in the directory but are only available until the device is restarted. The previous data is restored if the device is switched-off or after a power failure.

User data and user-specific program data is excluded from write protection and is always applied.

The write filter must be switched off:

- When directories are created, which are to remain intact after a restart,
- When programs are installed.

When the write filter is switched on or off, the system must then be restarted.

i Note: write protection that is not configured properly can damage the installed software or operating system in the event of an error.

5 Information for electrically skilled persons

5.1 Fitting and connection



DANGER!

Electrical shock when live parts are touched.

Electrical shocks can be fatal.

Before carrying out work on the device or load, disengage all the corresponding circuit breakers. Cover up live parts in the working environment.

Install device in panel-mounted housing.

i Prevent condensation from condensing moisture! Before connecting to the mains voltage ensure that the device has reached room temperature.

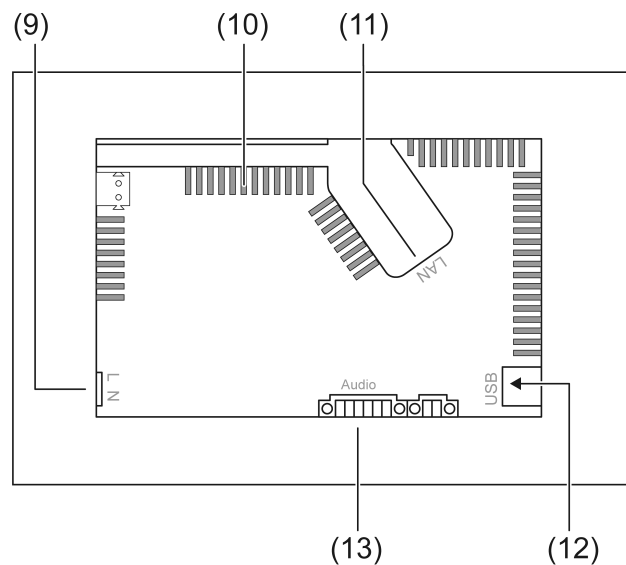

Figure 2: Rear side – Connections and ventilation openings

- (9) Mains connection
- (10) Ventilation openings
- (11) Ethernet connection
- (12) 2× USB-2.0 connections
- (13) Connection for Audio input and output

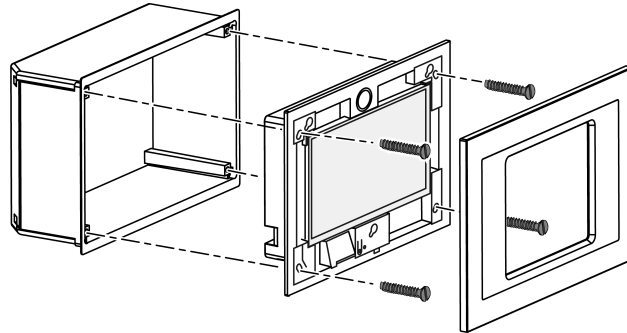

Figure 3: Installation in panel-mounted housing

- i** Recommendation: Install at eye-level, for optimal reading.
Use a Control-9 panel-mounted housing for the installation (Figure 3).
- i** For mounting in a panel-mounted housing of the information terminals: use an adapter frame.

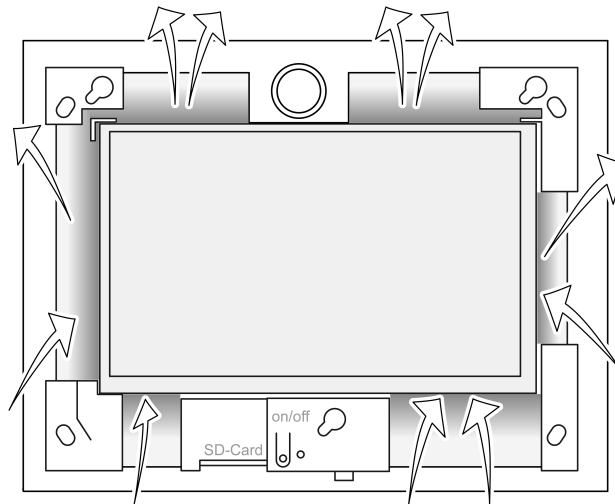

Figure 4: Ventilation openings, front side

Ensure sufficient cooling. Do not cover the ventilation openings on the front and rear side of the appliance box (Figure 4).

- i** Prevent the ingress of foreign bodies through the ventilation openings.
 - Pull the connecting cables through the designated bushings of the panel-mounted housing.
 - Install panel-mounted housing in the correct position in wall. Note labels **OBEN TOP** and **UNTEN BOTTOM**.
- i** Observe the mounting instructions of the installation housing.
 - Connect the device to Ethernet, audio devices and mains voltage depending on the requirements.
 - Install device in panel-mounted housing. Use the screws supplied.
 - Insert the Design frame in the correct direction into the designated brackets and push down and to the left to fix it.

Connecting the device to the Ethernet

Use the Ethernet connection (11) together with the supplied Ethernet adapter plug and Ethernet adapter cable to connect to the IP network.

Pay attention to the correct colour assignment of the wires, EIA/TIA-568-A or -B. This can be found in the documentation of the installed network components and routers.

- i** The Ethernet connection on the device is carried out according to EIA/TIA-568-B.

- Connect Ethernet cable to the Ethernet adapter plug. To do this, strip the Ethernet wires, do not skin, and insert into the cover of the adapter plug. Shorten any wires that are jutting out and push the cover onto the adapter plug in the correct position (Figure 5).
- Connect the supplied Ethernet adapter cable to the terminal (11) and Ethernet adapter plug.

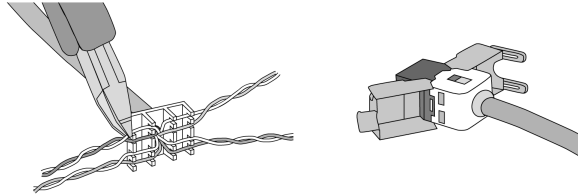

Figure 5: Connection of adapter connector to Ethernet cable

Connect audio devices

- Connect audio devices to terminal (13) (Figure 6).

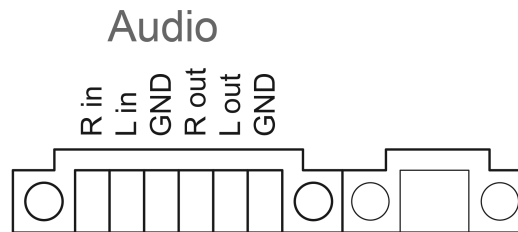

Figure 6: Connection assignment of audio connections

Labelling	Function
Audio R in	Input, audio signal, right
Audio L in	Input, audio signal, left
Audio GND	GND audio inputs
Audio R out	Output, audio signal, right
Audio L out	Output, audio signal, left
Audio GND	GND audio outputs

Table: Connection assignment of audio connections

Connect the device to the mains voltage



DANGER!

Electrical shock when live parts are touched. The mains voltage and low voltage are located in a shared appliance box. If there is an error, other connected components may carry mains voltage.

Electrical shocks can be fatal.

Always secure the mains voltage with the enclosed tube.

Run the cables so that low voltage wires are securely protected against mains voltage.

- Strip the mains voltage cable to the length of the enclosed tube.
- Pull the supplied tube over the stripped mains voltage wires **L** and **N**.
- Connect the mains voltage **L** and **N** to terminal (9).

5.2 Commissioning

First start-up

Settings such as for the screen language and the network configuration can be made after the first start-up.

The device can manage a maximum of five languages in operation. Icons to quickly enable the screen language in English, French, Dutch and German are preinstalled on the desktop. Other language packs are included on the provided recovery stick and can be installed through the Windows control panel.

 By using the operating system, the user accepts the terms and conditions. The terms and conditions can be found on the desktop.

When first turning on the device, we recommend following these procedures:

- Switch on device.
After booting the operating system, the message about activating write protection appears:
"Der Schreibschutz wird aktiviert. Anschließend wird das System neu gestartet." After 60 seconds write protection is automatically activated.

When settings have been made the following should be performed:

- Prevent write protection activation with **Abbruch** .
- Activate the screen language to English, French, Dutch or German with the preinstalled icon.
The device signs off the current user.
- Log in again on the device with the username **Control** and password **gira** .
- If necessary, prevent write protection activation with **Abbruch** .
- Apply other settings and installations depending on the requirements.
- Activate write protection.

Write protection

Symbol in the info area of the Windows taskbar

- ı Write protection active
- ⌋ Write protection not active

Activate write protection

- Tap with a finger on the ⌋ symbol in the taskbar.
- **OK** press.
Automatic restart in 10 seconds. Windows will shut down and restart.
Write protection is active.

Deactivate write protection

- Tap with a finger on the ı symbol in the taskbar.
- **OK** press.
Automatic restart in 10 seconds. Windows will shut down and restart.
After the restart the following message will appear
"Write protection is active. The system is then restarted."

 Click on "Cancel" within 60 seconds, otherwise write protection will be activated.
Write protection is deactivated.

Information on software installation

 Write protection must be deactivated for the duration of the software installation.

- i** The memory space actually available on the device is indicated if write protection is deactivated and the device has been restarted.
- i** For detailed information on the installation of the Gira software packs use the instructions in our download area at www.gira.de.
- i** Ensure that every installed software has the required licences.

Installing Gira software packs

The Gira software packs (e.g. TKS-IP gateway) can be found in the Gira download area. After downloading, copy the software to a USB stick.

- Deactivate write protection.
- Copy the installation file on the **Control 9 Client 2** and execute there locally.
- Follow the instructions in the installation software for further installation.
- Make other necessary settings. This could be for example:
Enter the IP address of the KS-IP gateway in the TKS communicator.
Mount the Design frame, in order to start the audio assistant if necessary and follow the instructions.
Start the Config-Editor in the QuadClient, enter the IP address of the HomeServer and select the desired design.
- Start the installed program.

Depending on the firewall setting, a security warning may be triggered with the first program start.

- Confirm the security warning with "Do not block" and "Allow access".
- Quit all programs.
- Activate write protection.

Restore operating system

If the Gira Control 9 Client 2 does not load the installed operating system correctly anymore, there may be serious damage to the operating system. In this case the operating system can be reinstalled.

- i** Restoring the operating system resets device and operating system to delivery state. All existing project data, device settings, personal data as well as installed software packs will be deleted!

Preconditions:

The SD slot (3) is empty.

Recovery USB stick from Version I04 onwards (see accessories)

Keyboard with USB connection

Optional: USB hub

Optional: USB mouse

- Switch off device.
- Connect keyboard and recovery sticks via an USB hub.
Alternative: Connect the recovery stick with the front USB port and the keyboard with the rear USB port.
- Switch on device.
- As soon as the Gira logo is displayed during the self-test press the F10 button on the keyboard.
- Select the **USB Recovery-Stick** entry in the **Please select boot device** menu and confirm with the enter key.

- i** The entry offered in the installation menu may change depending on the USB recovery stick used.

The system restoration is started.

- i** The system restoration may not be interrupted. Do not switch off the device during this time.

- Before the system restoration begins a security query will appear once again. Answer the **Do you want to continue** message with Y.
The operating system will be reinstalled. This operation can take approximately 20 to 30 minutes.

At the conclusion of the system restoration the **Recovery successfully finished** message appears.

- Remove recovery stick.
- Enter the **exit** command with the keyboard and confirm with the enter key.

The device is reinitialised when restarting. This operation can take several minutes.

- i** The icons 3 and ȳ display can be manually activated if it is not visible in the information area of the taskbar.

The icons 3 and ȳ display can be activated as follows:

- Open "Control Panel".
- Click on "Appearance and Personalization".
- Click on "Taskbar and Start Menu".
- Click on "Icons on the taskbar".
- Set "TraybarClient" to "Show icon and notifications".
The "TraybarClient" program is activated.
- Set "Flashmanager" to "Show icon and notifications".
The "Flashmanager" program is activated.

The icons 3 and ȳ are shown in the information area of the taskbar.

Required adaptation for QuadClient installation, relevant for QuadClient versions ≤ 4.5

In order to be able to use all the functions of the QuadClient, and installation adaption must be made for QuadClient versions ≤ 4.5.

To do this, the file "**hs_client_net.exe.config**" must be replaced in your installation path.

Work instruction:

- Copy the file "**hs_client_net.exe.config**" from the folder "**C:\Servicing\QCReadmeControl9.2**".
- Switch to the path "**C:\Users\Control\Documents\Gira\HS+FSExperte4.5\QuadClient\DE**" (example path for a German installation of QuadClient 4.5.).
- Insert the file "**hs_client_net.exe.config**" in the standard installation patch and replace the other file.

- i** This adaptation is not necessary for QuadClient versions > 4.5.

Required adaptation to use free visualisation

In order to properly display free visualisation, a design that is adapted to the resolution of Gira Control 9 Client 2 must be reloaded in HS Expert.

Details on how to do this, as well as the required design file, can be found in the Gira download area.

- i** Administrative rights are required for this process.

6 Technical data

Supply

Rated voltage

AC 110 ... 230 V ~

Mains frequency

50 / 60 Hz

Fine-wire fuse

Littelfuse/Wickmann 372 1160 T 1.6 L 250

Standby power	max. 1 W
Power consumption	max. 20 W
Power consumption	max. 8 W (Display off)
Ambient conditions	
Ambient temperature	0 ... +40 °C
Storage/transport temperature	-10 ... +70 °C
Relative humidity	10 ... 85 % (no moisture condensation)
Protection class	II (depending on installation)
Degree of protection (depending on installation, with design frame)	IP20
System	
Processor type	Intel® Atom™ E3825 dual-core
Clock speed	1.33 GHz
L2 cache	1 MB
Mass storage	16 GB M.2
RAM	2 GB RAM
Audio controller	Conexant CX 20709
Display	
Type	TFT 22.9 cm [9"], WVGA
Resolution	1024×600 pixels
Number of colours	16,7 millions
Observation angle	± 85°
Touchscreen	capacitive
Connections	
Audio input	Line-in, Stereo
Audio input	Line-in, Stereo
Memory card	SDHC, max. 32 GB
USB	
USB-Version	1.1/2.0
Connection	3× type A(2x back, 1x front)
Network	
Type	10/100 MBit/s Ethernet
Connection of LAN	RJ45-socket 8/4-pin
Dimensions	
Dimensions W×H×D	268×220×65 mm (without design frame)
Dimensions W×H	195×118 mm
Diagonal dimensions	22,9 cm

7 Conformity

Data according to EN directive 617/2013

Product type	Desktop-Thin-Client
--------------	---------------------

Manufacturer	Gira Giersiepen GmbH Dahlienstrasse Radevormwald
Model no.	GIRA Control 9 Client 2
Year of manufacture	Model 2017
Efficiency of the internal power supply unit	83.0% efficiency at 20% of the nominal load of 20 W 85.4% efficiency at 50% of the nominal load of 20 W 85.4% efficiency at 100% of the nominal load of 20 W
Test parameters	Test voltage 230V/50Hz Distortion factor of the test voltage 1.6% Power measuring unit Zimmer LMG95 Current-correct power measurement Power supply unit operated separately with electronic load GOSSEN METRAWATT 150R30 FLUKE 179 measuring device for adjusting the load current
Maximum power	$P_{\max} = 19.6 \text{ W}$
Idle power	$P_{\text{idle}} = 16.6 \text{ W}$
Power in idle state	$P_{\text{sleep}} = 0.93 \text{ W}$
Power in off state	$P_{\text{off}} = 0.73 \text{ W}$
Noise level	< 6 dB(A)
Measurement method	Test voltage 230 V Distortion factor of the test voltage 1.6% Power measuring unit Zimmer LMG95 Current-correct power measurement

8 Accessories

Design frame for Control 9	Order no. 2057 ..
Flush-mounted housing/flush-mounted box for Control 9	Order no. 2082 00
Flush-mounted housing	Order no. 0639 00
Adapter frame	Order no. 2081 00
USB stick for Gira Control 9	Order no. 2085 00

9 Warranty

The warranty is provided in accordance with statutory requirements via the specialist trade. Please submit or send faulty devices postage paid together with an error description to your responsible salesperson (specialist trade/installation company/electrical specialist trade). They will forward the devices to the Gira Service Center.

Gira
Giersiepen GmbH & Co. KG
Elektro-Installations-
Systeme

Industriegebiet Mermbach
Dahlienstraße
42477 Radevormwald

Postfach 12 20
42461 Radevormwald

Deutschland

Tel +49(0)21 95 - 602-0
Fax +49(0)21 95 - 602-191

www.gira.de
info@gira.de