

Mounting and
operating instructions

Surface-mounted hands-free feature
home station
1250 ..

GIRA



Device description

The surface-mounted hands-free feature home station is a prefabricated unit and is part of the Gira door communication system.

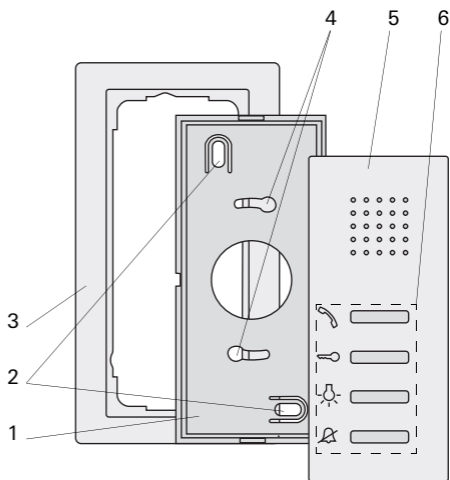

1. Mounting plate
2. Fixing holes for wall mounting
3. 2-gang cover frame without crossbar
(frameless installation only possible with wall mounting)
4. Fixing holes for box mounting
5. Housing, top section
6. Operating buttons



Electrical devices may only be installed and connected by a qualified electrician!

You can mount the surface-mounted home station

- on a flush-mounted or hollow-wall box (only with cover frame)
- directly onto the wall or on a wall lighting connection box (with or without cover frame)

Mounting with a cover frame is described in the following. Simply leave out the cover frame if mounting without a frame.

Box mounting

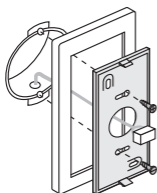

1. Place the mounting plate and cover frame onto the flush-mounted box.
2. Fasten the base plate to the support ring of the flush-mounted box with two screws.

Wall mounting

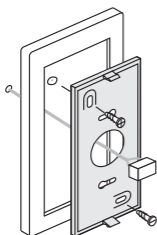

1. Strip the supply line up to the wall.
2. Select the mounting site so that the mounting plate is located centrally over the cable outlet and draw the drill holes.
3. Drill the two mounting holes and insert the plugs.
4. Fasten the base plate and cover frame to the wall with two screws.

Connection

If you have fastened the mounting plate to the wall, the home station is connected as follows:



1. Connect the 2-wire bus to the BUS terminals and the cables of the floor call button at the ET terminals of the connector if necessary.

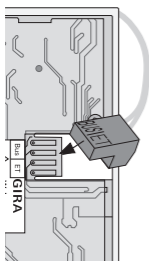

2. Push the connector onto the contacts of the device PCB on the back of the surface-mounted home station.



Note polarity

Ensure that the BUS and ET names match on the connector and PCB.

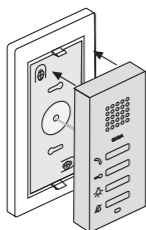

3. Now close the home station by placing the housing top section on the mounting plate and snapping it in.

Commissioning

Once you have installed all of the devices (door and home stations, control device etc.), you can start up the door communication system. Commissioning is described in the system manual included with the control device.



Max. number of call buttons

Note that up to 15 call buttons can be assigned to a surface-mounted home station.

Removal

Opening the device

To open the home station, carefully press the lower snap clip upward vertically with a screwdriver.

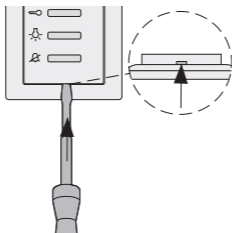

Pulling off plug terminal

The label on the rear of the device specifies the direction for pulling off the plug terminal.

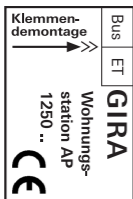

Assigning surface-mounted home station video via floor-call button

If you cannot access the flat during start-up, you can also assign the surface-mounted home station video via a connected floor-call button:



1. **Control device:** press the "Systemprog." button for 3 s to start the programming mode.



2. Press the call button on the **door station** for 3 s. Release the call button following the brief acknowledgement tone sounds.



3 The door station outputs a long acknowledgement tone.



3. Press the **floor-call button of the home station** to be assigned for 3 s. Release the floor-call button after the brief acknowledgement tone sounds.



3 A long acknowledgement tone indicates successful assignment.



Only possible with home station connected directly

With several parallel home stations, only the home station connected directly to the floor-call button can be taught in via the floor call button.



4. Briefly press the "Systemprog." button on the **control device** to exit the programming mode.

Deleting all call button assignments via floor-call button

If necessary, the assignments to the surface-mounted home station video can also be deleted via a connected floor-call button:



1. **Control device:** press the "Systemprogr." button for 3 s to start the programming mode.



2. Press the **floor-call button of the home station** with the assignments to be deleted for 9 s.

A short acknowledgement tone sounds after 3 s and 6 s. Continue to press the floor-call button until a long acknowledgement tone (9 s) sounds.

3 All assignments of the surface-mounted home station video are deleted.



3. Briefly press the "Systemprogr." button on the **control device** to exit the programming mode.

Operation



Operating buttons



The following functions are executed via the four operating buttons of the surface-mounted hands-free feature home station:



Accepting a call

The  button flashes for 2 min for an incoming call.



Briefly press the  button to start intercom communication with the person at the door station. The  button illuminates continuously during the call.



Maximum conversation time

The maximum conversation time is 2 min. When this time expires, the conversation is automatically ended.

Enforcement function





If the background noises at the door station are so loud that automatic switching of the speech direction is not guaranteed, you can use the enforcement function at the home station.



For this purpose, press and hold the  button while speaking. While the button is being pressed, only the person at the home station can speak and be heard.



To release the voice control to the door station, release the  button again.

Ending the call

- 1 x   To end the voice connection, briefly press the  button.
The illumination of the  button goes out.

Setting the speech volume



The speech volume is changed to one of four levels during intercom communication.

- 1 x   Press the  button briefly to increase the speech volume during the call.





There are four volume levels in total. The next-highest volume is set with each button press. When the loudest level is reached, the next button press sets the quietest volume level.

Opening the door

- 1 x   Press the  button.
If several doors are present, the door opener whose door station made the door call is operated within 2 min. It switches to the main door 2 min after the start of the call or 30 s after the door call is ended.



Switching light on



(only in conjunction with a switching actuator)

- 1 x   Press the  button to switch the light (e.g. the outdoor or staircase illumination) on.

Setting the call tone volume



The call tone volume is changed to one of four levels when no intercom communication is in effect.

3 s   Press the  button for approx. 3 s.



  There are four volume levels in total. The next-highest volume is set with each button press (3 s). When the loudest level is reached, the next button press sets the quietest volume level.

Deactivating/activating the call tone

You can deactivate the call tone of the home station when there is no intercom communication.

1 x   Briefly press the  button to deactivate the call tone.

The  button illuminates continuously while the call tone is deactivated.

1 x   Press the  button briefly again to reactivate the call tone.

The illumination of the  button goes out.



Only deactivate the call tone if necessary

Deactivate the call tone in special cases only. Otherwise, you run the risk of not hearing the ringing in an emergency, for example.

Setting the call tone melody

The surface-mounted hands-free feature home station offers five call tone melodies, which can be individually assigned to the floor call button, the call buttons of the door station or the internal call buttons of other home stations. This allows, for example, a different door station call button with an individual call tone melody to be assigned to each person (e.g. parents, children) in a household with several people.

The call tone melody is set as follows:

M. Meier



1. Trigger the call tone whose melody you would like to change by pressing the corresponding call button which was previously taught in.





2. To change the melody of the last triggered call tone, press and hold the  button on the home station.

3. Then press and hold the  button within 3 s as well until the new call tone melody is heard.

4. To select the next call tone melody, repeat Steps 2 and 3.



3 Each time the  and  buttons are pressed, a new call tone melody is set. When the last call tone melody is reached, the next button press starts over at the first melody.



Note

When deleting a call button assignment to a home station, the relevant call tone melody is reset to the factory setting.

Acceptance of guarantee

The warranty is provided in accordance with statutory requirements via the specialist trade. Please submit or send faulty devices postage paid together with an error description to your responsible salesperson (specialist trade/ installation company/electrical specialist trade).

They will forward the devices to the Gira Service Center.

Gira
Giersiepen GmbH & Co. KG
Elektro-Installations-
Systeme
Postfach 1220
42461 Radevormwald
Deutschland
Tel +49 (0) 21 95 / 602 - 0
Fax +49 (0) 21 95 / 602 - 191
www.gira.de
info@gira.de

GIRA