

**4-Channel time-switch**

Order no.: 1074 00

**1.0** Description**2.0** Features**3.0** Application / Installation

- 3.1 Safety instructions
- 3.2 Installation instructions
- 3.3 Electrical connection
- 3.4 Technical data
- 3.5 Dimensions illustration

**4.0** Power Reserve

- 4.1 Battery loading
- 4.2 Battery changing

**5.0** Initial Operation

- 5.1 Entry adjustment
- 5.2 Setting date and time
- 5.3 Selection schedule for automatic Summer/Winter time
- 5.4 Changing automatic Summer/Winter time
- 5.5 Radio time switch
- 5.6 Connection and adjustment of the radio antenna
- 5.7 Initial operation of the radio time switch
- 5.8 Forced transmitter call
- 5.9 Changing date/time

**6.0** Manual Intervention in the Program

- 6.1 Permanent switching **ON / OFF**
- 6.2 Manual **ON / OFF** (override switching)
- 6.3 Random program
- 6.4 Random program **Start**
- 6.5 Stop Random program/override switching
- 6.6 Locking/unlocking the keyboard

**7.0** Programming

- 7.1 Programming weekly program
- 7.2 Programming data program
- 7.3 Programming single switching times
- 7.4 Programming pulse program

**8.0** Priority program

- 8.1 Programming weekly program with weekly program P1-P9
- 8.2 Setting time period for the weekly program
  - A. Recurring annually
  - B. Program only in specified year
  - C. Stipulating public holiday without fixed date
- 8.3 Time limited permanent switching

**9.0** Program Interrogation

- 9.1 Whole program interrogation
- 9.2 Interrogation of designated switching times
- 9.3 Interrogation of channel related date program
- 9.4 Interrogation of date completely
- 9.5 Interrogating weekly program with priority

**10.0** Changing a stored program**11.0** Cancellation

- 11.1 Cancellation of individual switching times
- 11.2 Cancellation of date program
- 11.3 Cancellation of priority program
- 11.4 Cancellation channel by channel
- 11.5 Cancel everything

**12.0** Data Exchange/External Data Security

- 12.1 Recording data from time switch on the memory card
- 12.2 Reading data from memory card into the time switch

**13.0** Preview programming with software**14.0** Tips and Dodges**15.0** Glossary**16.0** Table of errors

## 1.0 Description of the Product

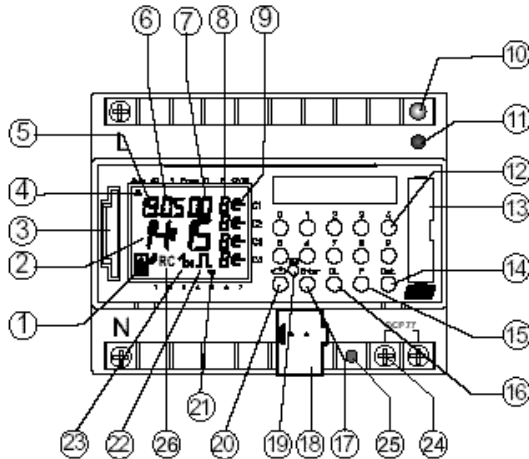

- 1 Display data exchange with memory card
- 2 Display hours
- 3 Interface
- 4 Cursor for program selection
- 5 Display date day
- 6 Display date month
- 7 Display year

- 8 Random indicator / P 1 .. 9 / Manual ON (H ∈ / Manual OFF (H ⊂)
- 9 Display status ON = ∈, OFF = ⊂
- 10 LED-BCU
- 11 BCU-Prog. button
- 12 Buttons 0 – 9 for program entry
- 13 Battery compartment
- 14 Button for entry of date switchings
- 15 Button for entry of priority programs/changes
- 16 Button for cancellation of programs and program steps
- 17 Button for entry of input
- 18 Bus-connection
- 19 RES = Reset / the micro-processor makes a defined new start
- 20 Program selection button for menu selection
- 21 Cursor for display of days of the week 1 = Monday, 2 = Tuesday..
- 22 Display for pulse programming
- 23 Display 1 x shows single switchings
- 24 Bus connection terminal DCF
- 25 LED lights up with DCF antenna reverse polarity
- 26 Display DCF 77 reception

## 2.0 Features Yearly Time Switch

- 4-Channel-Yearly Time Switch
- Time switch programming or PC programming using Windows from 3.1 / Win 95 / WIN NT with software **OBELISK**
- The time switch can be programmed up to the year 2063 in advance
- Data transfer and security possible with memory card
- Data can be transferred from time switch to time switch, from time switch to PC and vice versa
- **Functions:** switching, dimming, transmitting time, receiving time
- BCU integrated in unit
- 324 switchings for free block formation of channels and week days
- Stipulating public holidays without a fixed date
- Permanent switching times by means of EEPROM
- Day/Week/Year program
- Random program
- Pulse program
- Switching times: ON or OFF delay
- Automatic stipulating of public holidays without fixed date
- 1x-function for all date-related switching times
- 10 priority programs consisting of 10 individual weekly programs per channel
- Time limited permanent switching ON/OFF
- Approx. 1.5 years battery reserve by means of exchangeable environmentally friendly lithium cell
- Option: radio controlled
- Up to 10 Time Switches or even products can be connected to one radio antenna.

### 3.0 Application

The time switch controls connected bus participants via a group address.  
It transmits either 1, 2 or 8-bit telegrams, including the time.  
With the time program and the corresponding application, the time can be transmitted and received via the BUS.  
Transmission of current switch-time or date telegrams is only possible in automatic mode.



#### 3.1 Safety instruction

Work on the European installation bus must only be carried out by qualified electrical technicians. National regulations and any valid safety conditions should be observed.

- The time switch and the bus line must be connected in accordance with applicable DIN – VDE guidelines and the ZVEI/ZVEH Handbook.

The time switch:

- Must only be operated with the data from the product database
- Must only be used in dry areas
- The time switch is suitable for use in environmental conditions with normal pollution
- The time switch is suitable for mounting on the 35 mm top-nat rail.

Unauthorised modifications to the equipment render the warranty invalid.

### 3.2 Installation Instructions

In spite of expensive protection measures, exceptionally strong magnetic fields can lead to the destruction of the micro-processor controlled time switch. We therefore recommend attention be given to the following points before installation:

- Use separate lead for the mains voltage supply.
- Suppress inductive loads with suitable RC filters.
- Do not mount product in direct proximity to sources of interference as e. g. transformers, contactors, PCs and TV and communication equipment.
- After suffering interference, we recommend, before re-setting, a RESET with a new initial set up (chapter 5.3).
- Strongly heat-generating products on the right side of the product shorten the life of the battery.

### 3.3 Electrical Connection

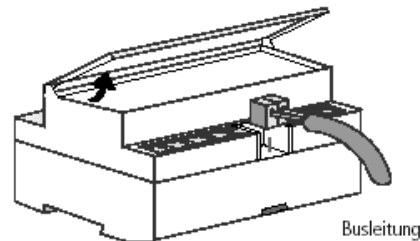

### 3.4 Technical Data

Description:	Yearly-Time-Switch
Program Type:	Day/Week
Operating voltage:	Bus-connection
Interval consumption:	< 150 mW incl. BCU
Time Base:	Quartz
Memory Locations:	324
Minimum Switching Time:	1 second/minut
Minimum Pulse:	1 second
Switching Accuracy:	Accurate to the second
Accuracy:	± 1 sec./day at 20° C
Power Reserve:	Lithium Cell 1.5 years at 20° C
Permissible Ambient Temperature:	- 10° C ... + 50° C (-10T50)
Protection Class:	II if installed according to EN 60335
Enclosure Type:	IP 20 in accordance with EN 60529
Type:	1 BSTU in accordance with EN 60730-1, -2, -7
Time Base:	Radio exact (with power reserve quartz operated)
Max. Distant of the radio antenna:	200 m
Enclosure Type:	IP 54 in accordance with EN 60529
Power Supply:	Necessary
Max. Loading:	10 products.

Note deviating technical data on the rating plate.  
Rights to technical improvements are reserved.

**Note**

The time switches conform to the European Regulations 73/23/EWG (low voltage rules) and 89/336/ EWG (EMV-Regulations).

If the time switches are used with other products in one installation, attention must be given to ensure that the whole installation does not cause radio interference.

**3.5 Illustration of Dimensions**

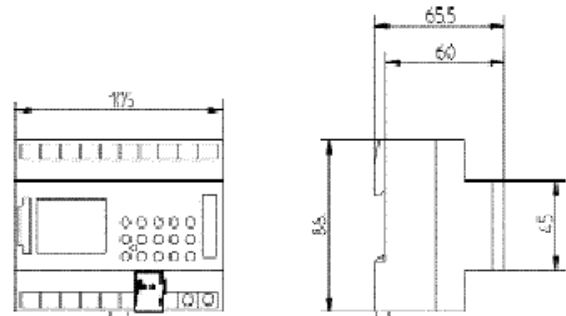

**4.0 Power Reserve**

**4.1 Battery Loading**

In the event of a power failure, the battery back-up provides for the maintenance of correct time (approx. 1.5 years). Even without power and with a drained battery, the switching times remain permanently stored.

- Note the polarity of the lithium battery.
- Insert the lithium battery into the holder (see diagram 1).
- Push the battery holder into the battery compartment.
- Press the battery holder down, until it audibly locates.

Dia. 1

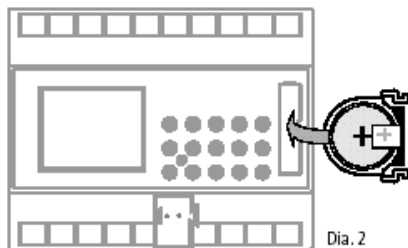
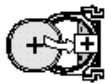

Dia. 2

**Important Instructions**

**Battery changing with mains voltage:**

All memorised program data is maintained.

**Battery changing without mains voltage:**

**Note:** date and time are lost.

1. Lift the battery draw with a suitable screw driver (see diagram 4).
2. Remove the lithium battery from the holder (see diagram 3).
3. Note the polarity of the new lithium cell.
4. Insert the Lithium battery into the holder (see diagram 1).
5. Push the battery holder into the battery compartment.
6. Press the battery holder down until it audibly locates.
7. Dispose of lithium battery in an environmentally friendly way. ♻️

Dia. 3

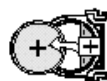

Dia. 4

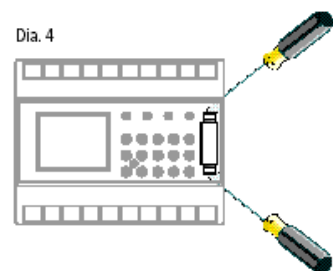



## 5.0 Initial Operation

Ensure that the lithium battery is located (Chapter 4.1).

Press the  button to move the cursor s.

The cursor moves each time a menu item button is pressed.

Cursor below symbol:	Function
<b>Auto</b>	(Automatic Program)  - Programmed switching times determine the switching programm - Switching override (Manual ON/OFF) - Random ON/OFF
	Set / change date and time
?	Interrogate, change, cancel, completely cancel
<b>Prog.</b>	Programming of date, weekly and 1x switching times  Programming of date, weekly pulses, 1x pulse, ON and OFF switching delays
	
<b>P</b>	e.g. public holiday, vacation, or holiday program
	Programming and change of Summer/Winter time switching

### Ending Programming:

Use  button, and place cursor s into following position.



### 5.1 Entry Adjustment

The time switches contains a prompt facility. Follow the flashing symbols. They show the programming sequence.

### Entry Adjustment:

**What to do when a wrong value has been entered in error?**

Cancel the program step again:

- press button **CL** = one step back
- press button **CL** repeatedly = repeated steps back

**When wrong value flashes:**

- enter correct value with buttons **0 .. 9**

**or when programming channels or week-days: or in the event of a wrong entry:**

- press the same button again

**Note:** Only the last entry will be cancelled

### 5.2 Setting date and time

On initial operation press button **RES** with a pointed object e.g. pencil, and afterwards release it.

#### Example:

The time switch is to be set up on 19.05.2000 at 9.25

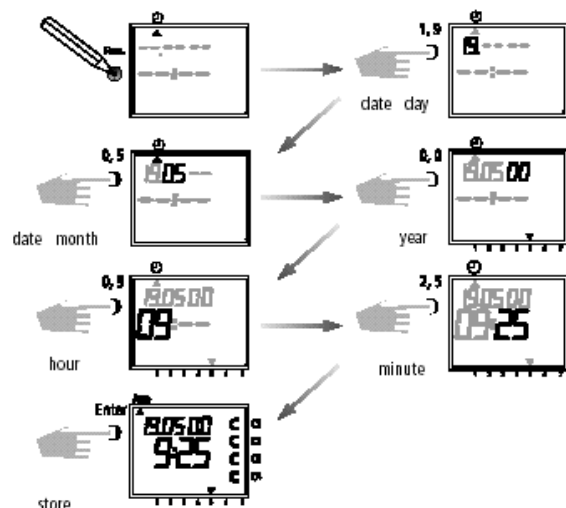

### Note:

After the initial operation (Chapter 5.3) automatic Summer/Winter time is already programmed.

- Basic setting is for Central Europe: **dat 1**.
- If another or no change over standard is required, this can be changed at any time, as described in Chapters 5.4 – 5.5.

**5.3 Selection Schedule for Automatic Summer-/ Winter time**

Setting	Commen- cement	Commen- cement	Area
dat 0	no change	no change	EU
dat 1	last Sunday in March 2:00 → 3:00	last Sunday in October 3:00 → 2:00	EU
dat 2	last Sunday in March 1:00 → 2:00	last Sunday in October 2:00 → 1:00	UK
dat 3	1st Sunday in April 2:00 → 3:00	last Sunday in October 3:00 → 2:00	North America
dat 4	individual Summer/Winter time table, programmable only with Obelisk software		

**5.4 Changing Automatic Summer/Winter time**

Default: 1074 00 dat 1

Select the new switching time (Chapter 5.3).

**Example:** basic setting **dat 1**

**Change to:** new regulation **dat 0**

**Note:**

For radio controlled time switch **1074 00 dat 0** is necessary.

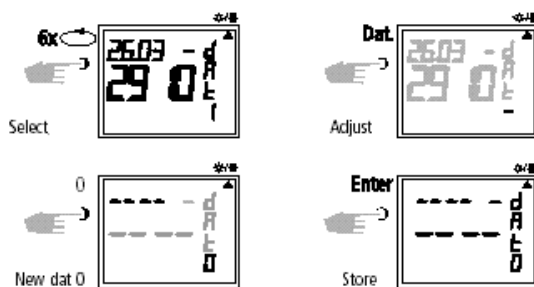

Back into automatic program with button

**5.5 Radio Time Switch**

The operation of the radio time switch is exactly the same without DCF-antenna.

The correct time, date and Summer-/Wintertime change-over set themselves automatically with me DCF 77 radio receiver.

**Interesting Details:**

- Accuracy of the radio receiver +/- 1 sec. in 1,000,000 years
- Transmitter location is Mainflingen near Frankfurt
- Transmitting radius of the transmitter approx. 1000 km
- Synchronisation is effected after initial setting-up and then daily at night.

**5.6 Connection and Adjustment of the Radio Antenna**

We recommend the following mounting positions:

- outside the control box (at least 4 m away)
- under the roof
- or in a protected position out of doors

Avoid mounting positions near:

- radio transmitting installations
- radiological equipment television and personal computers

**A. Operation without DCF 77 radio reception**

1. Connect the bus line only.
2. In this case, set the summer/winter change to the correct changeover standard, see Chapter 5.3/5.4.

**B. FW/S connection with radio reception**

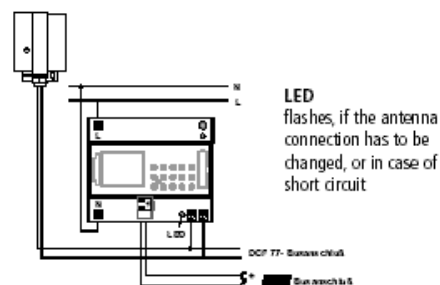

1. First connect the radio time switch to the 230 V mains supply and then to the bus line.
2. Connect only antenna to the time switch. In this case, the polarity of the connection is immaterial. The antenna signal is safety extra-low voltage. Ensure that there is safe isolation from the voltage supply.

**C. Adjusting the DCF radio antenna**

1. Set the radio antenna so that the LED installed in the front flashes at one second intervals.



**D. Connecting several radio time switches to the DCF antenna**

fig. 1

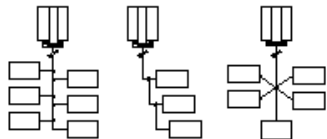

1. First, connect only **one** time switch to the 230 V mains supply, then connect to the bus line.

**Observe the following when connecting the antenna:**

2. Only after this, connect further time switch devices **to the antenna**.

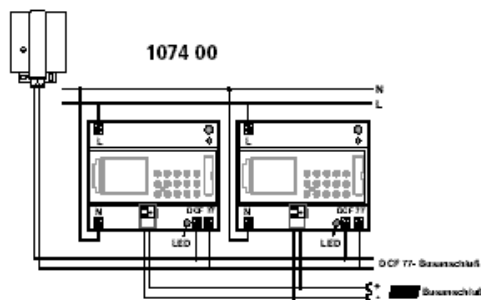

The connection to the **DCF** antenna may take the form of a star, bus or tree topology, see Fig. 1).

**Note:** If an LED at the **DCF** lights up, simply reverse the polarity at this connection!

3. **Following this**, connect the other devices first to the 230 V mains supply and then to the bus line.
4. Align the antenna, see Chapter **C**.

**5.7 Initial Operation of the Radio Time Switch**

**A. Setting-Up Automatically**

**Note:** During synchronisation press **no** buttons!

The synchronisation test would be discontinued immediately.

To obtain a new start after this, **RES** button must be pressed again.

1. The display counts from **00** to **59** (see illustration 2) Depending on the reception quality of the DCF 77 signal, this procedure can be repeated several times.
2. If the time switch has received the whole of signal, **RC** goes on flashing. Only after a further signal is received, does the **RC** symbol stop. The status of the channels are displayed (see illustration 3). The clock is now ready.

**B. Setting-Up Manually**

**Tip:** If the clock, on the initial set-up, does not synchronise even after several attempts, possibly because of a disturbed reception signal, we recommend setting-up as described in Chapter 5.3.

The clock will then try once more to synchronise itself on the signal, during the night.

**Example:**

The time switch has synchronised itself on 19.5.2000 at 9.25.

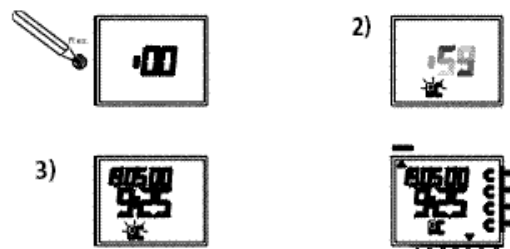

**5.8 Forced Transmitter Call**

The synchronisation of the time switch is effected after the initial setting-up, then daily between 1.58 and 3.13.

A radio synchronisation can be called up manually during the day (transmitter call).

**Start of the Transmitter Call**

1. Press **Dat** Button for approx. 3 secs.
2. then release

The timeswitch synchronises itself on the DCF 77 signal.

**In the LCD display can be seen:**

The **RC** symbol flashes only during a DCF 77 synchronisation!  
If the time switch has synchronised itself, a program review takes place.  
The channels take on, afterwards, the specified switching positions, from the individual program.  
The **RC** symbol is permanently in the LCD display.

**5.9 Changing Date / Time**

With the cursor in Pos. ⌚, any flashing value, the actual time or date, can be

- press **Enter** repeatedly, until the cursor is below **Auto**
- or follow the line and change the actual time

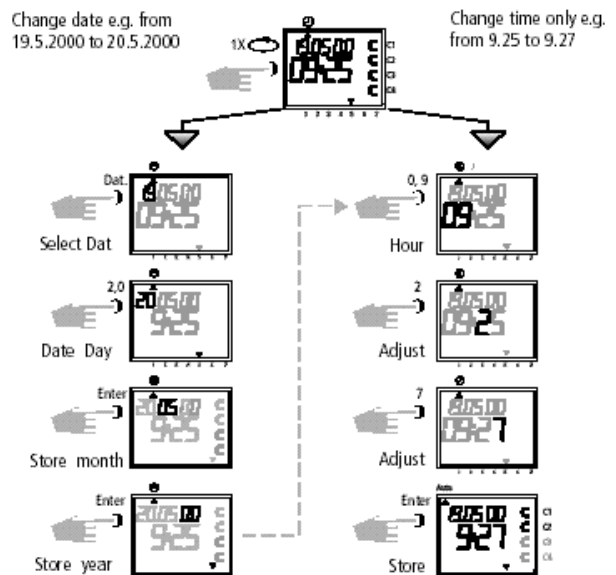

**6.0 Manual Intervention in the Program**

**6.1 Permanent ON / OFF**

Each channel can be manually switched in automatic menu to permanently **ON**.  
A permanent switching has highest priority. The channel remains in the permanently **ON** switching position until manually cancelled.

**Example:** Channel 1 permanent **ON**..

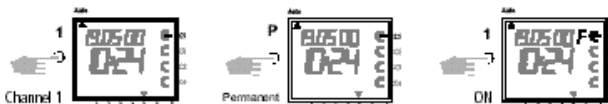

**Example:** Channel 1 permanent **OFF**.



Each channel can be manually switched in automatic menu to permanently **OFF**.  
A permanent switching has highest priority. The channel remains in the permanently **OFF** switching position until manually cancelled.  
After cancellation of a permanent switching the time switch effects a program recall. This results in the time switch checking the stored program and implementing the correct switching condition.

**6.2 Manual ON / OFF (override switching)**

Each channel can be switched **ON** manually in the automatic program. In which case, the symbol **H = hand** appears in the display.

An override switching is cancelled again by the next switching command. The **H** display is turned off.

**Select Channel:**

e.g. Button **1** = Channel C1, Button **2** = Channel C2 etc.

**Select Status:**

Button **1** = Switch ON, Button **0** = Switch OFF

**Example:**

Switch ON Channel **C2** manually, press button **2**, once (press 1).

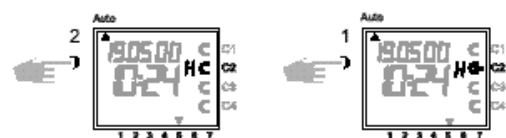



Each channel can be switched OFF manually in the automatic program. An override switching in the automatic program is corrected again by the next switching command. (The **H** symbol is turned off).

**Select Channel:**

e.g. Button **1** = Channel C1, Button **2** = Channel C2 etc.

**Select Status:**

Button **1** = Switch ON, Button **0** = Switch OFF

**Example:**

Switch OFF Channel **C2** manually, Button **2**, press.

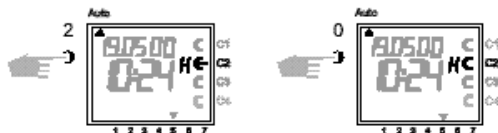

**6.3 Random Program**

**General Comment**

A random program causes the time switch to switch ON or OFF at random between one or more pairs of switchings (ON and OFF switching time).

Duration of the random ON and OFF switching time approx. 10 – 120 minutes.

The random program can be selected individually for each time channel.

**Example:**

Between 19.00 and 22.00 random ON (display: r)  
Between 0.00 and 06.00 random ON (display: r)

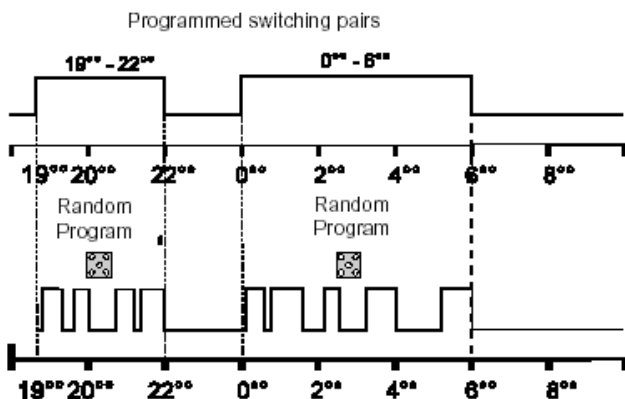

**6.4 Random Program Start**

A random program can be switched ON manually in the automatic program (Auto) at any time. It remains active until switched OFF (chapter 6.5).

**Note:**

If the random program is active in a channel, the symbol **r** (random) appears beside the channel.

**Example:**

Switch ON random program in Channel **C2**.

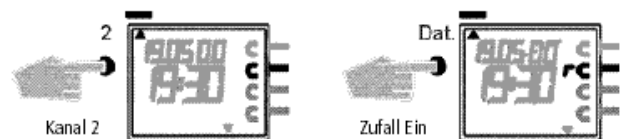

**6.5 Stop Random Program / override switching**

A random program override switching can be interrupted at any time.

After cancellation of the random program override switching, the time switch carries out a program review. This causes the time switch to inspect the stored program and then take up the correct switching status.

**Example:** Stop random program Channel **C2**.

**Note:** The symbol **r** turns OFF.



**6.6 Locking/ unlocking the keyboard**

**Effect:**

The memory card allows you to prevent operation of the device by unauthorized persons. In this case time switch query and programming are impossible without the memory card.

**Locking the keyboard:**

1. Insert the memory card into the data interface.
2. Press key **8** for approx. 3 secs until the **Obelisk** icon  is flashing.

**Operating the time switch**

If after a button is pressed and the Symbol  is blinking, the keyboard is locked.

1. Insert the memory card into the data interface.
2. You can select the desired program using the  key.
3. Now you can remove the memory card in order to continue programming.  
When the time switch returns to auto mode, the keyboard is locked.

**Canceling the keyboard lock**

1. Insert the memory card into the data interface.
  2. Press key **8** until the icon  appears.
  3. Press key **8** for approx. 3 secs until the icon disappears.
  4. Remove the memory card.
- Now the time switch can be operated again without obstruction.

**7.0 Programming**

**7.1 Weekly program, set switch ON time**

e.g.: Channels **C1** and **C3** are to switch on at 6.30 from Mon to Fri ☐.

Place cursor ▲ in pos. **Auto** ☐ ? **Prog** JL P ✱/✱

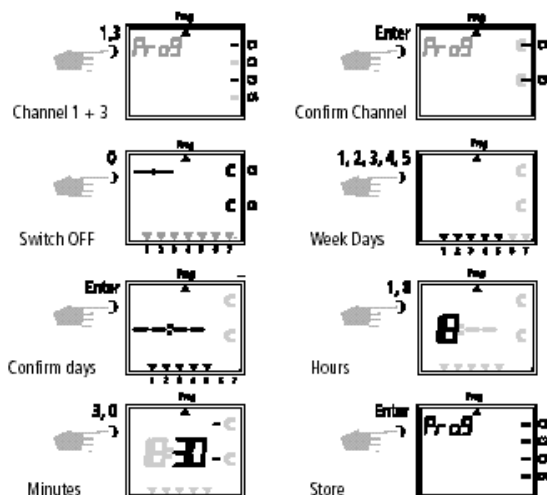
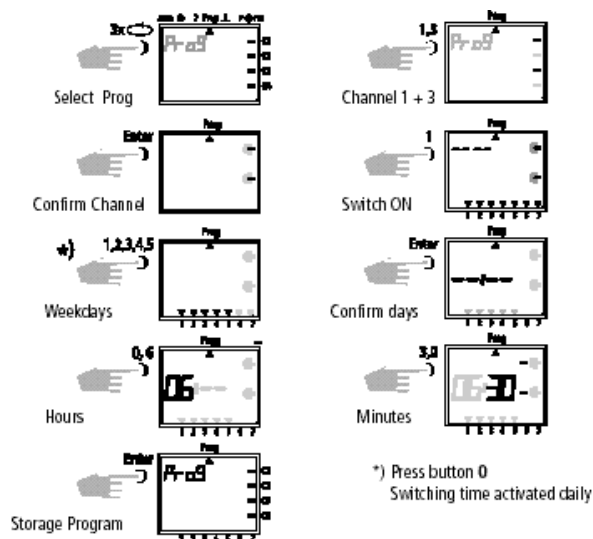

Additional programming as described, or back into the automatic program with button .

**7.2 Programming Date Program Example.:**

Channel **C1** is to switch ON yearly on the 1.5 at 7.30.

Place cursor ▲ in pos. **Auto** ☐ ? **Prog** JL P ✱/✱

**Example 2:**

**Weekly program – set switch OFF time**

Channels **C1** and **C3** are to switch OFF at 18.30 from Mon to Fri ☐.

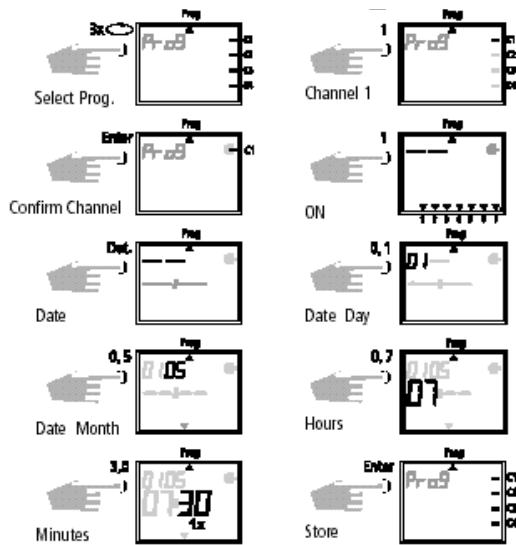

Additional programming as described or back into the automatic program with button

**7.3 Programming Single Switching Time**

**Example:**

Channel **C2**, 1 switch ON on the 10.5 at 8.30.

**Note:** Only date related switching times can be programmed with the function **1x** see illustration 10. Once the switching time is effected, it cancels itself automatically at mid-night.

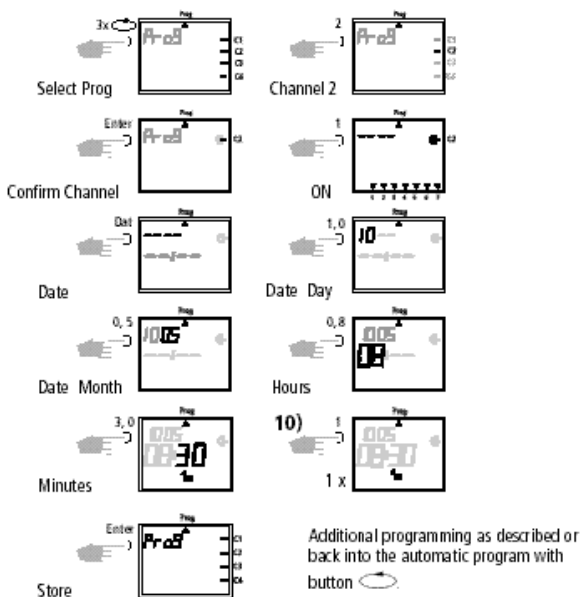

**7.4 Programming Pulse Program**

**Example:**

Channels **C1** and **C2** pulse duration: 5 secs from Mon to Fri at 7.15..

Place cursor ▲ in pos. **Auto** **?** **Prog** **⏏** **P** **\*** **\***

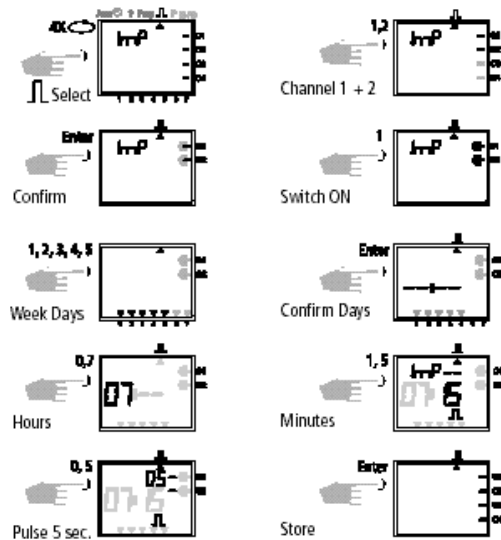

**Note:**

After a time adjustment, pulses are only effected, which are programmed at least one minute after the time adjustment.

## 8.0 Priority Program

With the time switches up to 9 different weekly programs can be performed in addition to the normal weekly program. A firm weekly program **P1 ... P9** can be requested at any fixed periods of time.

That is, the programming consists of:

1. Setting the weekly program (see Chapter 8.1)
2. Setting commencement and completion date (see Chapter 8.2)

If the time period of several weekly programs cut across one another, the program with the highest index number prevails e.g. weekly program **P9** prevails over weekly program **P3**.

In order to maintain control, we recommend that the various weekly programs are noted in the table at the end of the user instructions.

Switching times are executed in the following order:

- Permanent switching
- 1x switching times. Chapter 7.3.
- Time limited permanent switching. Chapter 8.3 (out priority over ON).
- Date switching times. Chapter 7.3 (out priority over ON).
- Weekly program with priority. Chapter 8.2/8.3 (P9 priority over P1).
- Weekly program. Chapter 7.1/7.2.
- etc.

### Weekly Program Schedule with Priority

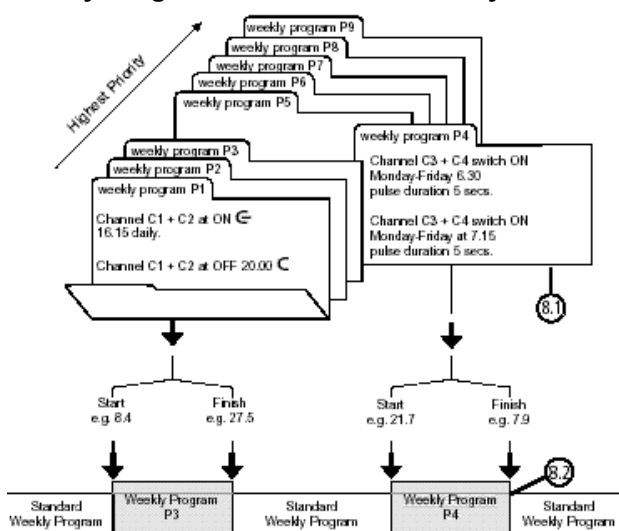

When changing to a new weekly program (e.g. on 8.4 at 0.00 hr), all channels in questions are switched as if the new weekly program has been valid for some time. This means the new weekly programme makes a review of the program.

### 8.1 Programming Weekly Program with Priority P1 .. P9

#### Example:

Channel **C1** and **C2** switch on daily at 8.15 Weekprogram get priority sequence **P1**.

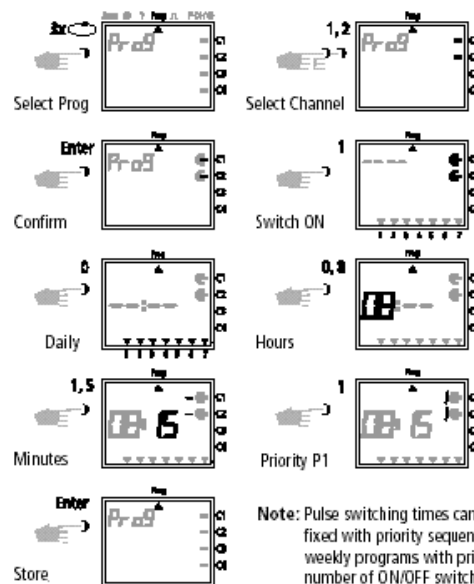

Note: Pulse switching times can also be fixed with priority sequence. For weekly programs with priority, any number of ON/OFF switching commands can be specified.

### 8.2 Setting Time Period for Weekly Program P1 .. P9

#### A. Recurring annually

The time period of a weekly program **P1 .. P9** is fixed by entering a commencement and finishing date. The weekly program begins at 0.00 on the commencement date and ends at 2400 on the finishing date.

**Example:** As opposed to the normally active program on Channel **C2** from **8 April** until **27 May**, the individual priority program with index **P1** is to become effective. In the fixed time period with priority sequence **P1 .. P9**, the whole standard program (without priority sequence) is suppressed.

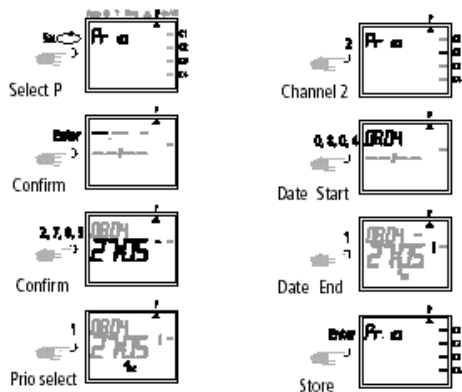

Additional programming as described or with button back into the automatic program.

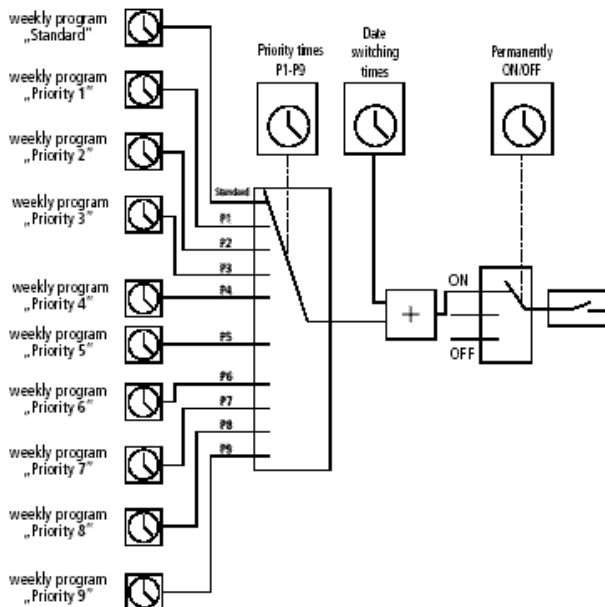

**B. Weekly program only in one specified year**

**Example:**

Only in year 2000 from 8th April to 27th May, e.g. the weekly program P2 activated.

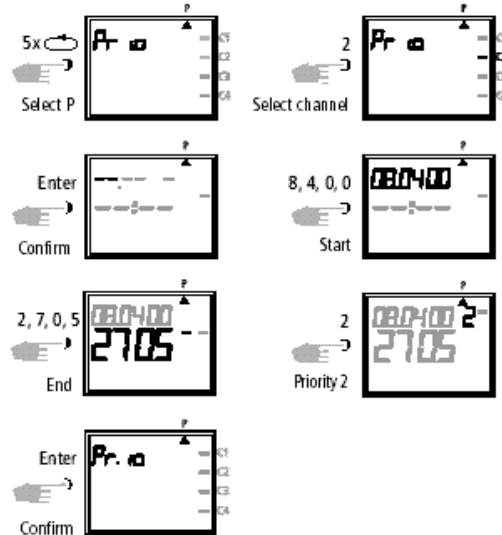

**C. Stipulating public holidays without a fixed date**

**Example:**

Following this measure, a public holiday such as Easter (not a fixed date) will be activated automatically and will execute, e.g., program P2.

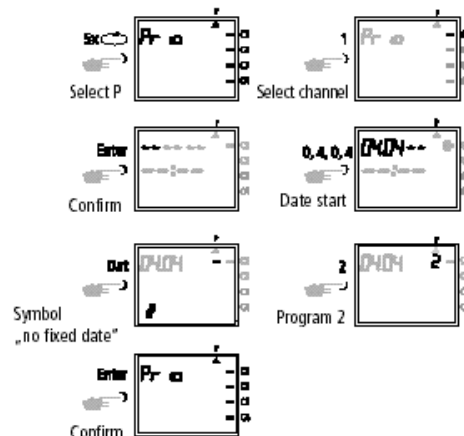

**Note:**

Programming of public holidays without fixed dates only needs to be carried out once, e.g. following initial start-up.

This applies to holidays connected with Easter such as Ascension, Whitsun, Corpus Christi, Ash Wednesday, Good Friday etc. Program the date of **all** of these holidays that do not have a fixed date **once** only for the **current** year.

**8.3 Time Limited Permanent Switching ON or OFF**

**E.g.:**

All connected equipment is to remain switched OFF during the Christmas holidays between **23 December** and the **7 January**.

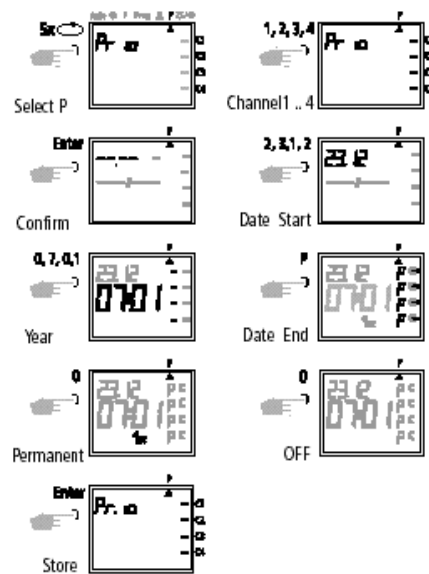

Additional programming as described or with button back into the automatic program.

**9.0 Programe Interrogation**

**9.1 Whole Program Interrogation**

Menu Selection cursor under ?

By pressing **ENTER** button (several times) interrogate whole program.

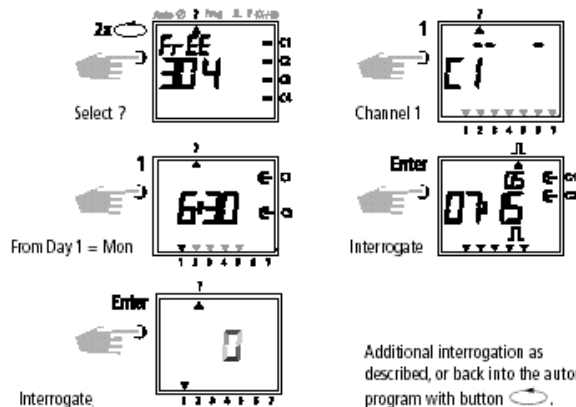

Additional interrogation as described, or back into the automatic program with button .

**9.2 Interrogating Only Designated Switching Times**

- 1. Illustration:** menu selection and display of the free memory locations e.g. **304**
- 2. Illustration:** e.g. select channel **1** (press button **1**).
- 3. Illustration:** begin interrogation e.g. from Mondays: button **0, 1** press. (**C3** is displayed likewise, as jointly programmed as a block).

**9.3 Interrogation of Channel Related Date Program**

**Illustration 1:** Menu selection and display of the free memory locations e.g. **304**

**Illustration 2:** Select Channel e.g. **C1**, press button **1**

**Illustration 3:** Select date program, press button **Dat**

**Illustration 4:** Begin interrogation e.g. from May  
Button **0**, press **5** (interrogation from February Button **0**, press **2** etc.)

**Illustration 5:** Search for the desired switching time press **Enter** Button e.g. on 1.5  
Channel **C1** ist urned on at 7.30

**Illustration 6:** Example, memory searches for additional switching times

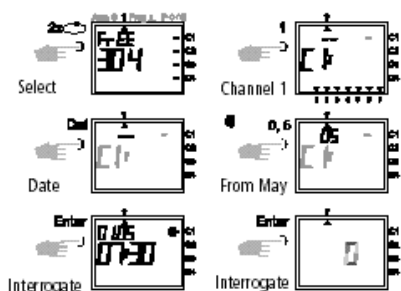

With Button back into the automatic program (Auto).

**9.4 Complete Interrogation of Date Program**

The complete interrogation of the date program is effected as described in 9.3.

The entry step in illustration 4 (button 0,5) must be omitted in this case.

All stored date related switching times will be shown one after the other from January (01).

**9.5 Interrogating weekly program with priority**

**Fig. 1:** Display of available memory space 210

**Fig. 2:** Select: Channel **C1**

**Fig. 3:** Only have priorities displayed

**Fig. 4:** Priority selection, have everything displayed with priority **2**

**Fig. 5:** Press **Enter** to have further programs with priority **2** displayed

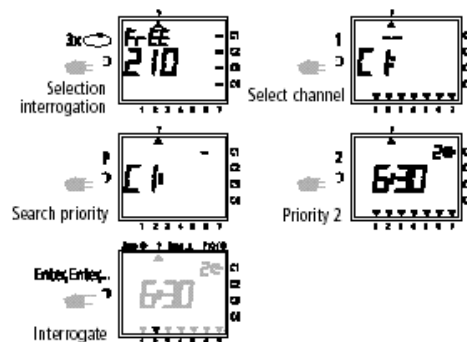

**Note:**

If, while in interrogation mode, a date, the year and the symbol are displayed, then this indicates a public holiday without a fixed date.

To cancel:

Press button to return to the automatic program.

**10.0 Changing Stored Program**

Any program already stored, whether weekly or yearly can be changed depending on individual requirements.

**Condition:**

Cursor must be in the interrogation menu (?).

**Example:**

**Illustration 1:** example: free memory locatins **304**

**Illustration 2:** Button **1** of selected Channel **C1**

**Illustration 3:** By repeatedly pressing the **Enter** Button, call up the switching time to be changed

**Illustration 4:** Button **P** = adjustment

**Illustration 5:** e.g. Channels C2, C4 ON  
 – **change channel sequence:**  
 with **Button 1, 2, 3, 4**  
 – afterwards store with **Enter** Button  
 – retain channel sequence:  
 progress with **Enter** Button

**Illustration 6:** Store channel selection

**Illustration 7:** Switching status e.g. switch ON  
 – **change switching status:**  
 with Button **0,1**  
 – **retain switching status:**  
 progress with **Enter** Button

**Illustration 8:** Programmed weekdays  
 – switching times are effected on  
 the day, Mo to Fr (1 – 5)  
 – **changing weekdays: e.g.: not**  
 Wed, Sat, Sun press Button **3, 6, 7**  
 – **retain weekdays:** progress with  
**Enter** Button

**Illustration 9:** Store change

**Illustration 10: Change switching time:** e.g. 7.45  
 press Button 7, 4, 5  
 – afterwards store with **Enter**  
 Button  
 – **retain switch time:** progress  
 with **Enter** Button

**Illustration 11:** Search for additional switching  
 times, press **Enter** Button

## 11.0 Cancellation

### 11.1 Cancellation of Individual Switching Times

**Illustration 1:** Menu selection ? and display of free  
 memory locations e.g. **304**.

**Illustration 2:** Select channel, e.g. C1, press Button  
**1**.

**Illustration 3:** Commence search from day 1 =  
 Monday, press Button **1**.

**Illustration 4:** Search for switch times: press **Enter**  
 Button.

**Illustration 5:** Cancel: press **CL** Button and then  
**Enter** Button.  
 Discontinue cancel procedure: press  
**CL** instead of **Enter** Button.

**Illustration 6:** **Enter** Button: memory searches for  
 additional switching times.

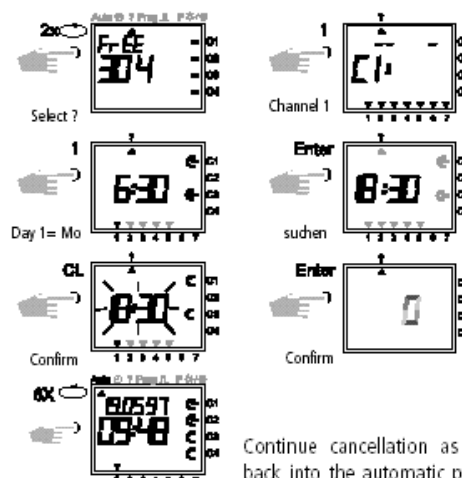

Continue cancellation as described, or  
 back into the automatic program (Auto)  
 with button .



11.2 Cancellation of Dat Program

- Illustration 1: Menu selection ? and display of free memory locations e.g. 304
- Illustration 2: Select channel e.g. C1, press Button 1
- Illustration 3: Select date switching times, press Dat Button
- Illustration 4: Begin interrogation from January: press Button 0, 1 (February 0, 2 etc.)
- Illustration 5: Search for the switching time to be cancelled, press Enter Button.
- Illustration 6: Cancellation of the switching time: press CL Button and afterwards Enter.
- Illustration 7: Enter Button: memory searches for additional switching times.

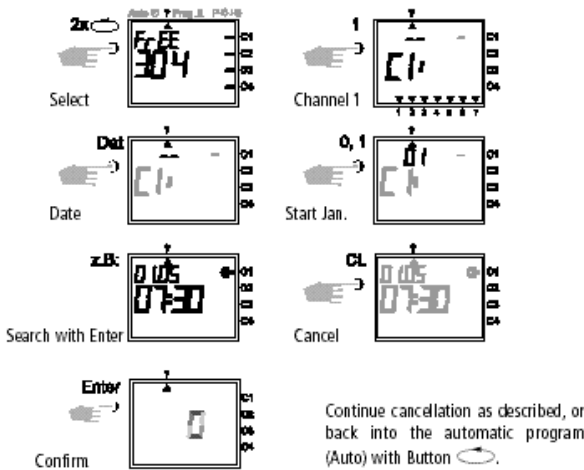
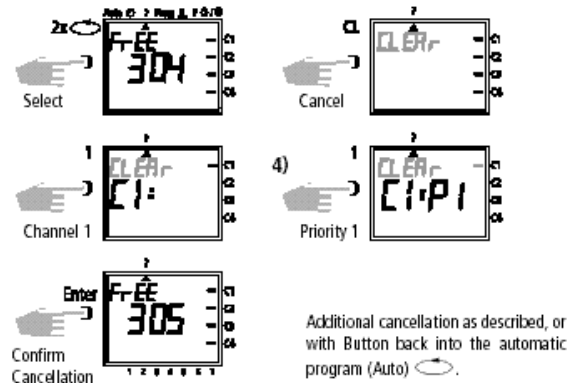

11.3 Cancellation of the Whole Priority Program

- Illustration 1: Menu selection ? and display of free memory locations e.g. 304
- Illustration 2: Initiate the cancellation procedure, press CL Button
- Illustration 3: Select channel e.g. C1, press Button 1
- Illustration 4: Select the priority program for cancellation e.g. P1, press Button 1 Discontinue cancellation procedure, press CL Button again
- Illustration 5: Confirm cancellation procedure, press Enter Button

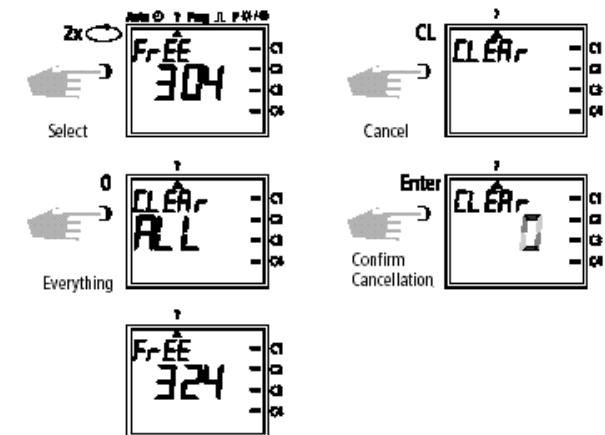

11.4 Complete Program Cancellation of One Channel

The program of one channel can be cancelled completely.

The cancellation is effected as described in Chapter 11.3. The entry step in Illustration 4 (Button 1) must be omitted in this case.

11.5 Cancel Everything

- Illustration 1: Menu selection ? and display of free memory locations e.g. 304
- Illustration 2: Cancel program, press Button CL
- Illustration 3: Cancel everything, press Button 0 Discontinue cancellation, press CL Button again
- Illustration 4: Confirm cancellation, press Enter Button
- Illustration 5: Display 324 memory locations, all switching times are cancelled

With Button back into the automatic program (Auto).

## 12.0 Data Exchange / Security

Switching times of time switch can be stored externally with the memory card.

The data can be filed or transferred from time switch to time switch.

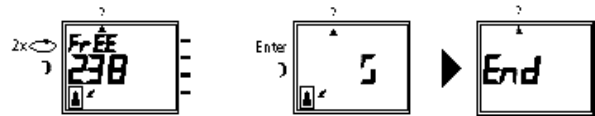
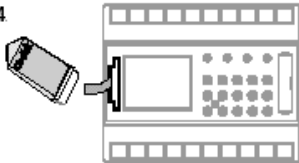

Illustration 4



### 12.1 Entering Data from Timeswitch onto Memory Card

Push the memory card into the data interface (Illus. 4). Select menu ?.

Enter data on the memory card: press **Enter** button. The data is transferred when the **End** symbol is displayed in the LCD.

Remove memory card. Back into the Auto menu with Enter button.

### 12.2 Reading Data from Memory Card into Time Switch

Push the memory card into the data interface (illus. 4). Select menu **Prog**. Read data in, press **Enter** button. The data is transferred, when the **End** symbol is displayed in the LCD.

Remove memory card. Back into the **Auto** menu with **Enter** button.

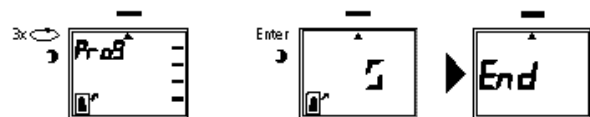

## 13.0 Preview Programming with Software OBELISK

As an option, the possibility exists for preparing a program on the computer with the software program. The prepared program can be written onto the memory card and also be printed out. The memory card can now be as secure data or for reading into another time switch.

### Condition:

- PC from 486 free hard disk storage capacity approx. 1 MB
- from WIN 95 to WIN 98 / WIN NT

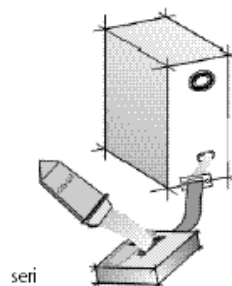

Order No. contains:

Software program **OBELISK** + system adapter + memory card.

## 14.0 Tips and Additional Possibilities

### 1. Priority Program with Random Switching

Possibility for starting a random program automatically during public or annual holiday times.

1. Program weekly program with the desired ON and OFF switching times and priority sequence **P1 .. P9** (Chapter 8.1)
2. Specify the time period for the weekly program (Chapter 8.2).
3. Activate random program once manually (Chapter 6.4).

### 2. Special Program for holidays

Procedurally during holidays to switch ON and OFF connected units at different times:

1. Program your desired holiday program. The ON and OFF switching times must occur daily. A priority sequence **P1..P9** must be assigned to the switching times (Chapter 8.1).
2. Specify the time period for the weekly program e.g. only for the 1st May → begin 01.05 finish 01.05 (Chapter 8.2).

### 3. Pulse Program for Time delayed Switch-ONs

A switch-ON time e.g. at 7.0 and 10 secs can be achieved by:

1. Programming a switch-ON time e.g. 07.00 ON (€) (Chapter 7.1)
2. Additional pulse program (Chapter 7.4) with same switch-ON time.

1. Switch-ON time e.g. 07.00  
€
2. Additionally at 07.00 pulse  
OFF (C) for the duration of  
10 secs
3. Effective at 07.00 10 secs  
switch ON

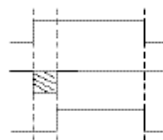

### 4. Pulse Program for Time Delayed Switch-OFF

A switch-OFF time e.g. at 8.0 and 10 secs. can be achieved by:

1. Programming a switch-OFF time eg.g. 08.00 (Chapter 7.1)
2. Additional programming of a simultaneous pulse switching time of 10 secs. duration.

1. Switch-OFF time e.g.  
08.00 OFF (C)
2. Additional pulse ON (€)  
at 08.00 for 10 secs duration
3. Effective at 08.00 10 secs.  
switch OFF.

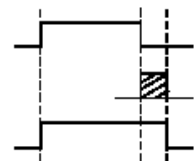

**Note:** After time adjustment, only pulses, which are programmed at least 1 minute after the time adjustment are carried out.

### 5. Channel Block Formation

If not all memory locations are to be used, we recommend you dispense with channel block formation when programming switching times.

This provides advantages when changing or cancelling individual switching commands.

**Note:** After a time adjustment, only pulses, which are programmed at least 1 minute after the time adjustment, are carried out.

## 15.0 Glossary

### What does automatic operation (Auto) mean?

The cursor is below **Auto**. Current time is displayed. The switching sequence of the time switch is determined by the stored switching times.

### What is automatic return?

When in the interrogation or programming mode, if no button is used for a long time, the display reverts automatically, after approx. 40 secs. to automatic operation. The product then takes up the switching status specified by the program.

### Program recan?

This results in the time switch checking the stored program and implementing the correct switching condition.

### What does entry correction mean?

In the event of wrong entry during programming, by pressing the **CL** button, the entry can be cancelled and immediately corrected.

### What does weekday block formation mean?

Simultaneous programming at one switching time e.g. 06.00 ON on several days of the week e.g. Monday, Tuesday and Friday.  
Only one memory location is used.

### What does channel block formation mean?

Simultaneous programmed switching times, which are effective in several channels, take up only **one** memory location.

#### **Advantage:**

Faster programming of the switching times.

### What does memory card mean?

Mobile data carrier can be used for:

- security of the programmed time program
- duplication of the programmed time program
- faster programming of additional time switches with the same program

Option only with software OBELISK:

- programming on the PC, store on memory card
- read program into time switch(es)
- program print out possible

### What does RESET mean?

By pressing the RESET button, a defined new start for the time switch is effected. The current time and date are cancelled. The stored switching times are maintained permanently.

### What does EEPROM mean?

An EEPROM is an electronic memory, which can store memorised data even without current (without battery back up) for a period of approx. 40 years.

### What is an LCD?

An LCD display is a liquid crystal display, with which current time and stored data (switching times) can be shown.

## 16.0 Table of errors

In order to increase the reliability of operation, several internal tests are run by the time switch. If any error appears during these tests, the LCD will display the following error numbers.

### **Error no. 4, 5, 6, 7:**

Error in the transmittance of data memorized in the memory card.

1. Transfer program once again onto program card.
2. Repeat transaction.
3. No success.

### **Error no. 3:**

Program card has been withdrawn prior to end of data transfer.

### **Error no. 1, 2, 8:**

Program memory defect.

## Acceptance of guarantee

We accept the guarantee in accordance with the corresponding legal provisions.

**Please return the unit postage paid to our central service department giving a brief description of the fault:**

Gira  
Giersiepen GmbH & Co. KG  
**Service Center**  
Dahlienstrasse 12  
D-42477 Radevormwald



The CE sign is a free trade sign addressed exclusively to the authorities and does not include any warranty of any properties.

Gira  
Giersiepen GmbH & Co. KG  
Postfach 1220  
D-42461 Radevormwald

Telefon: +49 / 21 95 / 602 - 0  
Telefax: +49 / 21 95 / 602 - 339  
Internet: [www.gira.de](http://www.gira.de)