

DALI Gateway



Table of Contents

1	<u>Product definition</u>	<u>3</u>
1.1	Product catalogue	3
1.2	Function	3
2	<u>Fitting, electrical connection and operation</u>	<u>4</u>
2.1	Safety instructions	4
2.2	Device components	5
2.3	Fitting and electrical connection	6
2.4	Commissioning	10
2.5	Operation	11
3	<u>Technical data</u>	<u>18</u>
4	<u>Software description</u>	<u>20</u>
4.1	Software specifications	20
4.2	"DALI Gateway C00Cx2" software	21
4.2.1	Scope of functions	21
4.2.2	Software information	22
4.2.3	Object table	24
4.2.4	Functional description	28
4.2.4.1	Application basics	28
4.2.4.2	Functions affecting several devices	37
4.2.4.3	Description of functions affecting all channels:	47
4.2.4.4	Channel-oriented functional description	49
4.2.4.5	Scene function	82
4.2.4.6	DALI commissioning	89
4.2.4.7	DALI test	102
4.2.4.8	Delivery state	109
4.2.5	Parameters	110

1 Product definition

1.1 Product catalogue

Product name: DALI Gateway
Use: Gateway
Design: REG (rail-mounted device)
Order no.: 1060 00

1.2 Function

The DALI Gateway represents the interface between a KNX/EIB installation and a digital DALI (Digital Addressable Lighting Interface) lighting system. The DALI Gateway allows the switching and dimming of a maximum of 64 lamps including DALI device (e.g. electronic ballast). Each DALI lamp can be assigned up to 32 different lighting groups that are controlled via the KNX/EIB. This permits the integration of a room-specific light control of, for example, open-plan offices, multi-purpose rooms, assembly shops and training classrooms and lecture rooms into the higher-level KNX/EIB building management. In addition, the lighting groups can be integrated into up to 16 scenes that makes it possible to recall pre-programmed light moods or to save new light scenarios.

The DALI Gateway permits the separate feedback of individual switching and brightness states of the DALI groups to the KNX/EIB. In addition, the general DALI operating status can be reported to the KNX/EIB (error status, short-circuit, status of supply voltage).

The controls (4 pushbuttons) on the front panel of the device permit to manually dim or switch the DALI light groups on and off in parallel with the KNX / EIB even without bus voltage or in a unprogrammed state (broadcast of all connected DALI lamps). This feature permits to quickly test the operability of connected consumers.

The DALI Gateway is able to check the devices integrated into the DALI system for integrity. The replacement of a defect electronic ballast device by a new one, for example, can be detected if the "Automatic device replacement" has been activated. The decoding of the parameterized data into the new electronic ballast device is carried out fully automatic by the Gateway without any special commissioning. That makes the corrective maintenance of a DALI system much easier.

The configuration and commissioning of the DALI Gateway takes place via a plug-in that is integrated into the ETS 3. For project design and commissioning of this device it is recommended to use the ETS3.0d. The advantages with regard to downloading (shorter loading times) are available only if this new ETS patch version or later versions are used. Other tools besides hardware and software are not required for the commissioning of the device.

The functionalities that can be preset with the ETS independently for each lighting group include, for instance, separately parameterizable brightness ranges, extended feedback functions, disable function or, alternatively, a forced-control position function, separately adjustable dimming response, time delay and Staircase timer function with pre-warning and soft dimming functions.

Moreover, each lighting group can be integrated into up to 16 scenes with different brightness values. Centralized switching of all groups is also possible. In addition, the brightness values of the groups can be set separately in case of bus voltage failure or bus voltage return and after programming with the ETS.

The Power for the DALI Gateway is entirely supplied by the separate mains connection. The mains voltage has to be switched on for controlling the DALI interface or programming with the ETS. The device is designed for fitting on mounting rails in closed compact boxes or in power distributions in fixed installations in dry rooms.

2 Fitting, electrical connection and operation

2.1 Safety instructions

Electrical equipment must be installed and fitted only by qualified electricians. Observe the current accident prevention regulations.

Failure to observe any of the installation instructions may cause damage to the device and result in fire and other hazards.

Before working on the device or before replacing the connected DALI devices, disconnect the supply voltage (by cutting out the circuit breaker) to avoid the risk of an electric shock.

The DALI Gateway is not suited for safe disconnection of the mains supply.

DALI is a functional extra-low voltage (FELV) device. Safe separation between KNX/EIB and DALI and mains voltage in installations must be ensured. A minimum spacing of 4 mm must be ensured between bus wires and DALI/mains conductors.

Do not open the device and do not operate it outside the scope of the technical specifications.

2.2 Device components

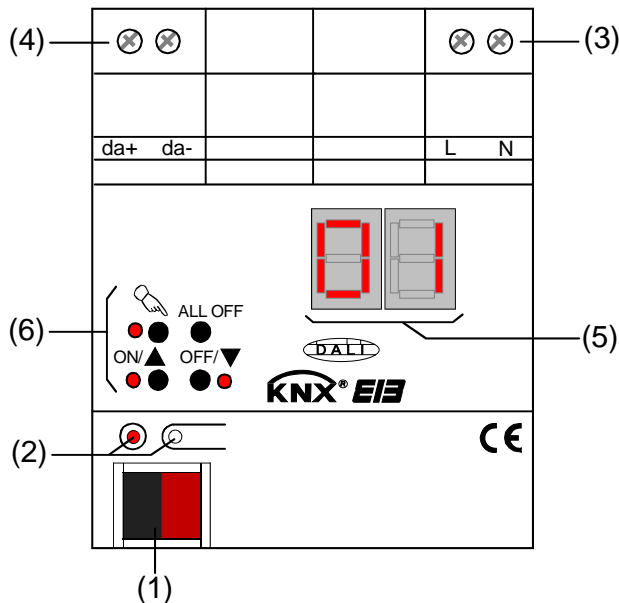

- (1): KNX/EIB bus connection
- (2): Programming key and programming LED (red). The programming LED blinks slowly when the safe-state mode is active.
- (3): Screw terminals (L,N) for connection of mains voltage supply
- (4): Screw terminals (da+, da-) for connection of DALI line
- (5): 2-digit 7-segment display (red) for the display of the selected DALI group ("01"... "32" / blinking = group disabled) in manual control mode or for the display of more information:
 - " - - ": Indicates DALI commissioning phase after an ETS programming operation or after mains voltage return. The display duration depends on the number of connected DALI devices (only briefly after mains voltage return).
 - "□ □ ": Display in an unprogrammed state during manual control.
 - "E □ ": Display of a false connection to the DALI connection terminals (da+, da+). Mains voltage connected. DALI Gateway does not operate. The Gateway is ready for operation only after the error has been eliminated and after a new initialization (mains voltage return).
 - "L E ": Indicates the automatic device replacement (cf. Chapter "2.5 Operation").
 - "E " : Indicates an error occurring during the automatic device replacement (cf. Chapter "2.5 Operation").

The 7-segment display is switched off during bus mode.

- (6): Keypad for manual operation with status LED

2.3 Fitting and electrical connection



DANGER!

Electric shock in case of accidental contact with live parts. Electric shocks can be fatal. Before working on the device, cut out the mains supply and cover up live parts in the surroundings!

Fitting

- Fit the device by snapping it onto the mounting rail in acc. with DIN EN 60715. The screw terminals should be on top.
- ⓘ A KNX / EIB data rail is not required.
- ⓘ Observe the temperature range (-5 °C ...+45 °C) and ensure sufficient cooling, if necessary.

Connecting the device in order to supply the device electronics and the DALI interface with power

- Connect the mains voltage and the DALI system as shown in fig. 1 (connection example).

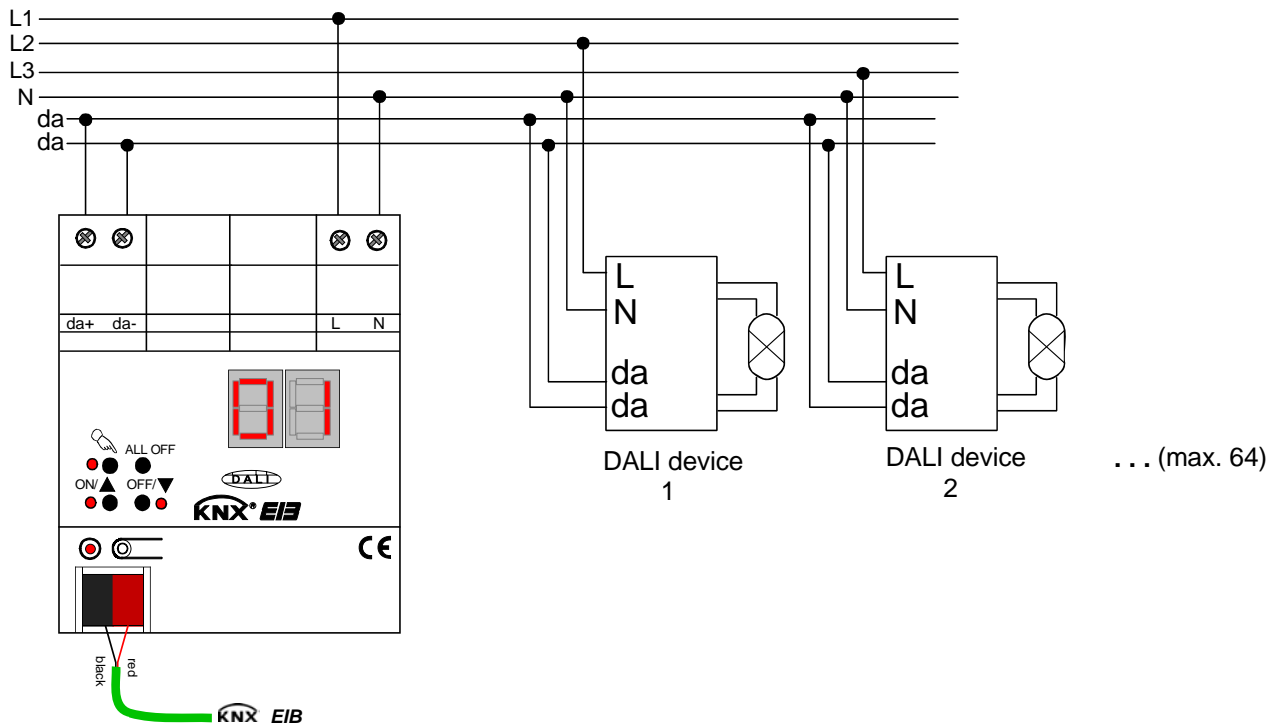

Fig. 1: Electrical connection of mains voltage and the DALI interface

- i** The DALI system voltage is a functional extra-low voltage (FELV). Thus, the DALI interface has to be treated like a live line in compliance with the applicable installation prescriptions. The DALI Gateway supplies the system voltage. The installation has to ensure that all mains voltages of the connected DALI devices as well as the mains voltage supply of the DALI Gateway will be switched off when activating a DALI section.
- i** For a better overview in the installation it is recommended to pay attention to the polarity of the DALI line. Basically, the compliance with the DALI polarity depends on the DALI devices that are used.
- i** DALI devices (max. of 64) can be connected to different phase conductors (L1, L2, L3).

Removing other control facilities

DALI devices from some manufacturers feature extended functions (operation with mains voltage at the DALI terminal). When using the DALI Gateway as a control unit in the DALI system, other existing control posts – especially when refitting existing systems – have to be removed, if necessary, from the installation!

- Remove all corresponding control facilities as shown in figure 2 or ensure that no other control posts exist.

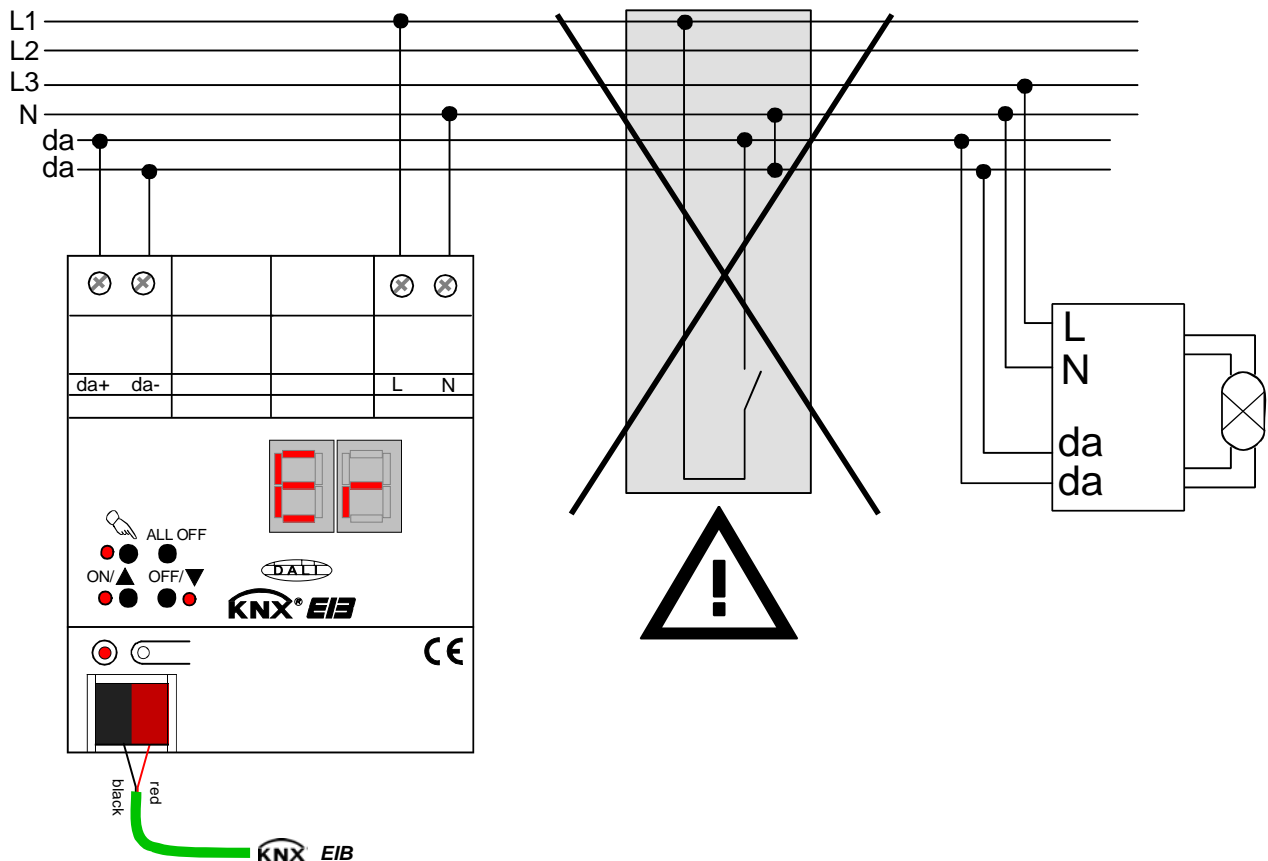

Figure 2: Removing other control facilities in the DALI system

- i** Other control posts may also be, for instance, DALI centers, DALI potentiometers or similar control components. These control posts have to be removed from the DALI system as well in order to avoid system conflicts.
- i** The DALI Gateway makes available the DALI system voltage. For this reason it is not permitted to introduce an additional DALI power supply into the installation in parallel with the Gateway.
- i** Only one DALI Gateway may be operated in a closed DALI system.
- i** If the DALI gateway detects mains voltage at the DALI terminal (terminals da+ and da-), it will shut off and display "E-".

Installing / removing the protective cap

To protect the bus lines against hazardous voltages, especially in the area of the connecting terminals, a protective cap can be installed.

The cap is installed with the bus terminal in place and the connected bus line led out at the rear.

- To install the cap: Slide the cap over the bus connecting terminal until it is heard to engage (cf. Fig. 3.A).
- To remove the cap: Remove the cap by pressing the sides slightly and by pulling it out to the front (cf. Fig. 3.B).

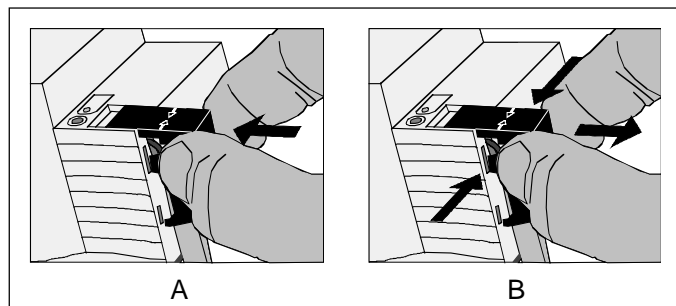

Fig. 3: Installing / removing the protective cap

2.4 Commissioning

After installation of the Gateway and connection of the bus line and the mains supply as well as the DALI lines, the device can be put into operation. The following procedure is generally recommended...



DANGER!

Electric shock in case of accidental contact with live parts. Electric shocks can be fatal. Before working on the device, cut out the mains supply and cover up live parts in the surroundings.

Commissioning the device

- Switch on the mains supply of the Gateway.
 - Switch on the bus voltage
Checking the voltages: the red programming LED must light up when the programming key is being pressed.
 - Program and project the physical address with the ETS.
 - The DALI Gateway is configured via a plug-in which is integrated into the ETS database. Start the plug-in (open the parameter view) and configure the KNX/EIB groups (cf. Chapter 4 “Software description”). Do not yet commission the DALI!
 - Close the plug-in and download the application program with the ETS.
 - Restart the plug-in (open the parameter view) and commission the DALI (cf. Chapter 4 “Software description”).
 - Close the plug-in in order to save the DALI configuration in the ETS database. Then proceed with downloading the application program again.
The DALI Gateway is now ready for operation.
- ❗ ETS programming will not be possible if the mains voltage is not connected to the DALI Gateway.
- ❗ The ETS plug-in will display a message during the closing, if the application program of the DALI Gateway has to be reprogrammed in the cases described.

2.5 Operation

The DALI Gateway permits all lighting groups to be operated manually. The keypad features 4 function keys and 3 status LEDs on the front panel of the device that can be used to set the following modes of operation...

- Bus mode: operation via touch sensors or other bus devices
- Temporary manual control: local manual control via keypad, automatic return to bus mode,
- Permanent manual control: local manual control via keypad

- ⓘ The control modes can be enabled or disabled via parameter settings in the ETS.
- ⓘ In manual control mode the groups cannot be controlled via the bus.
- ⓘ Manual control is possible only while the actuator is supplied with power from the mains. The manual control mode will be terminated in case of a bus voltage return or mains voltage failure. While in broadcast mode (unprogrammed DALI Gateway), a bus voltage return cannot abort the manual control.
- ⓘ In bus mode, the manual control can be disabled via a telegram. An activated disable function will terminate the manual control.
- ⓘ Further details concerning the manual control, especially with respect to the available parameter settings and the interaction with other functions of the Gateway, can be found in chapter 4. "Software description" of this documentation.

Controls and indicators for manual control

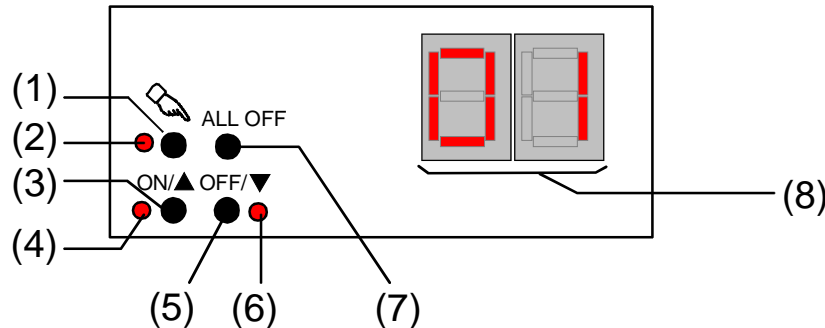

Fig. 4: Controls and indicators for manual control

- (1) key:
Activates / deactivates manual control
- (2) LED :
LED ON indicates permanent manual control.
- (3) ON/▲ key
Short press: Group ON / Long press: increases brightness of group.
- (4) Status LED ON/▲:
Indicates a group that is switched on (brightness: 1...100%) when LED ON in manual control mode).
- (5) OFF/▼ key:
Short press: Group OFF / Long press: reduces brightness of group.
- (6) Status LED OFF/▼:
Indicates a group that is switched off (brightness: 0%) when LED ON in manual control mode.
- (7) ALL OFF key:
All groups off (only in permanent manual control mode).
- (8) 7-segment display::
Indicates the selected DALI group for the manual control ("01"..."32" /blinking = group disabled). In addition, the following information can be displayed during a manual control...
 - "□ □ ": Manual control in unprogrammed state (broadcast mode). In this case, the DALI Gateway collectively controls all DALI devices present in the system via a broadcast command as there have been no group assignments yet (requires ETS commissioning).
 - "L E ": Indicates the automatic device replacement. The display duration depends on the number of connected DALI devices. The display will extinguish, if the device replacement could be completed without error.
 - "E ": Indicates an error that occurred during the automatic device replacement. The device replacement could not be carried out. The display will automatically extinguish after 3 seconds.

Priorities



The DALI Gateway distinguishes between different functions that can affect a DALI group. In order to prevent conflicting output states, each available function has been assigned a certain priority. The function with the higher priority overrides the one with the lower priority.

- 1st Priority: Manual control mode (highest priority)
- 2nd Priority: Forced-control position or disable function
- 3rd Priority: Direct bus mode ("Switching" & "Dimming" & "Brightness value" objects, scenes, centra function)

Switching on the temporary manual control for the broadcast function

The manual control for the broadcast function can be utilized while the DALI Gateway is in the unprogrammed state. As in this case no group configurations have been stored due to a missing ETS programming, the DALI Gateway will collectively control the connected DALI devices in manual control per broadcast command.

The DALI Gateway has not yet been programmed via the ETS.

- Press the  key briefly (< 1 s).
"  " is shown on the 7-segment display.
- ⓘ After 5 s without key-press, the Gateway will deactivate the manual control for the broadcast.
- ⓘ The Gateway is delivered with the broadcast mode activated. After programming via the ETS, it is also possible to reactivate the broadcast mode any time by unloading the application program via the ETS.

Switching on the temporary manual control for broadcast

The DALI Gateway has not yet been programmed via the ETS.



Temporary manual control mode for the broadcast has been activated.

- No key-press for 5 s
- or -
- Press  key twice.
- or -
- Switch off mains voltage supply.
Temporary manual control mode for broadcast has now been terminated. The 7-segment display will extinguish.
- ⓘ When shutting off the temporary manual control mode for broadcast, the state selected by manual control will not change.

Switching on permanent manual control mode for broadcast



The DALI Gateway has not yet been programmed via the ETS.

Manual control mode or temporary manual control mode for broadcast has not been activated.

- Press the  key for at least 5 s.
The  status LED is illuminated. "  " is shown on the 7-segment display. Permanent manual control mode for broadcast has been activated

Switching on the permanent manual control mode for broadcast



Permanent manual control mode for broadcast has been activated.

- Press the  key for at least 5 s
 - or -
 - Switch off mains voltage supply.
Permanent manual control mode for broadcast has now been terminated. The  status LED and the 7-segment display will extinguish.
- i** When shutting off the temporary manual control mode for broadcast, the state selected by manual control will not change.

Operating DALI devices in manual control mode for broadcast

The DALI Gateway has not yet been programmed via the ETS.

Manual control mode (permanent or temporary) has been activated.

- Operate the devices by pressing the ON/ key or OFF/ key.
Brief press: Collective switch on/off.
Long press: Collective increase/decrease of brightness.
Long press & releasing: Stopping collective dimming.
All connected DALI devices will immediately execute the corresponding commands.

Switching off all DALI devices in manual control mode for broadcast

Permanent manual control mode for broadcast has been activated:

- Press the ALL OFF key.
All connected DALI devices will be immediately switched off (brightness: 0 %). The devices are not locked. Collective activation is again possible after shutoff.
- i** The "ALL-OFF" function is not available in temporary manual control mode.

Activating temporary manual control mode

If the DALI Gateway has been programmed at least once via the ETS, at least one DALI group will be created and configured. In this case, the created groups can be individually controlled via manual control. The broadcast mode will be deactivated.



The DALI Gateway has been programmed at least once via the ETS.

Manual control has been enabled in the ETS.

- Press the  key briefly (< 1 s).
The group number "01" will be shown on the 7-segment display.
- i** After 5 s without a key-press, the Gateway automatically returns to the bus mode.
- i** The Gateway is delivered with the broadcast mode activated. After programming via the ETS, the broadcast mode can be reactivated any time by unloading the application program via the ETS.

Deactivating the temporary manual control mode

Temporary manual control mode has been activated.

- No key-press for 5 s
 - or -
- select all groups successively by a brief press of the  key. Now press the  key once more.
 - or -
- Shut off power supply or reset bus (bus voltage return).



The temporary manual control mode is now terminated. The 7-segment display will extinguish.

-  When shutting off the temporary manual control mode, the state selected by manual control will not change. If, however, a forced-control position or a disable function has been activated via the bus prior or during the manual control, the DALI Gateway will execute the disable or forced responses for the affected groups.

Activating the permanent manual control mode



The DALI Gateway has been programmed at least once via the ETS.

Manual control has been enabled in the ETS. Bus mode or temporary manual control mode has been activated.

- Press the  key for at least 5 s
 - The  status LED lights up. The group number "01" will be shown on the 7-segment display.
 - Permanent manual control mode is now activated:

Deactivating permanent manual control mode

Permanent manual control mode is activated.

- Press the  key for at least 5 s
 - or -
- Shut off power supply or reset bus (bus voltage return).
 - The permanent manual control mode for broadcast has now been terminated. The  status LED and the 7-segment display will extinguish.

-  Depending on how the Gateway has been parameterized in the ETS, the groups will be set to the state last adjusted via manual control or to the state internally tracked (direct control, forced-control position / disable function) when shutting off the permanent manual control.

Controlling a DALI group manually

The DALI Gateway has been programmed at least once via the ETS.

Manual control mode (permanent or temporary) has been activated.

- Select desired group: Press the \otimes key briefly (repeatedly, if necessary).
The 7-segment display will display the group number of the activated DALI group. The "ON/▲" (1...100 %) or "OFF/▼" (0 %) status LED on the keypad indicates the brightness of the group.
- Control the group by pressing the ON/▲ or OFF/▼ key.
Brief press: Switching on/off.
Long press: Increasing/decreasing brightness.
Long press & releasing: Stop dimming.
The activated DALI group will immediately execute the corresponding commands.

Switching off all groups

Permanent manual control mode has been activated:

- Press the ALL OFF key.
All groups are shut off immediately (brightness: 0 %). The groups are not locked. Subsequently, they can again be individually controlled.

i The "ALL-OFF" function is not available in temporary manual control mode.

Disabling bus mode of individual groups manually

The DALI Gateway has been programmed at least once via the ETS.

Permanent manual control mode has been activated:

The disabling of the bus mode must have been enabled in the ETS.

- Select group: Press the \otimes key briefly (repeatedly, if necessary)
The 7-segment display will display the group number of the activated DALI group. The "ON/▲" (1...100 %) or "OFF/▼" (0 %) status LED on the keypad indicates the brightness of the group.
- Press the ON/▲ and OFF/▼ keys simultaneously for at least 5 s.
The relevant DALI group is now disabled (no bus mode possible).
The 7-segment display for the relevant group is blinking.

i To unlock, proceed in the same way.

i A group that has been disabled manually can only be operated in the permanent manual control mode.

DALI device replacement

After the start of the automatic device replacement, the DALI Gateway can check the DALI system for the integrity of the DALI devices that have been previously put into operation. If, for instance, the installer has replaced a defect DALI electronic ballast device with a new one, the DALI Gateway is able to program the new electronic ballast device with the project data of the failed electronic ballast device. Thus, it is possible to replace a failed DALI device by a simple operation on the device without having to set parameters with the ETS.

The DALI Gateway has been programmed at least once via the ETS.

The automatic device replacement must be activated in the ETS.

Bus and mains voltage (on all DALI devices) must be switched on.

The DALI system must have already been put into operation via the ETS plug-in.

Only one DALI device may have failed and may be replaced.

The device must be in bus mode (no active manual control)

- Press the  and ALL OFF keys simultaneously for at least 10 s.

The automatic device replacement will be activated. The time required for this operation depends on the number of DALI devices available in the system. The 7-segment display indicates "LE" (Learn) during the device replacement. If the replacement has been successful, the display will extinguish.

- ❗ All other functions of the DALI Gateway are paused during the device replacement. The Gateway tracks all bus states received during the device replacement and regularly analyzes the values tracked last (switching, dimming, brightness value, scenes, central function, forced-control position, disable function) at the end of the automatic device replacement. The device replacement will interrupt any active forced-control position or disable function which will be activated again at the end of the replacement, if, in the meantime, the functions have not been deactivated via the bus. The behaviour as at the beginning of these functions will not be executed again.
- ❗ Make sure that only one DALI device is being replaced in the way described. In case several electronic ballast devices have failed (possibly not connected to mains voltage) and been replaced, the electronic ballast devices cannot be positively identified and automatically be configured. In this case, a new DALI commissioning via the ETS plug-in is required.
- ❗ If an error has occurred during the device replacement, the 7-segment display will indicate "E" (Error) for 3 s. The procedure has to be carried out again by following the requirements and details as mentioned above.
This signalling will take place even if the automatic device replacement has been activated without a prior DALI device replacement.

3 Technical data

Type of protection:	IP 20
Safety class:	III
Mark of approval:	KNX / EIB / VDE
Ambient temperature:	-5 °C ... +45 °C
Storage / transport temperature:	-25 °C ... +70 °C (Storage above + 45 °C reduces the lifetime)
Mounting position:	optional (screw terminals preferably on top)
Minimum distances:	none
Type of fastening:	Snap-fastening on DIN rail in closed cabinets (e.g. small distributions, etc.) / KNX / EIB data rail not required.
KNX / EIB supply	
Voltage:	21...32 V DC SELV
Power consumption:	typically 150 mW
Connection:	standard KNX/EIB bus connection terminal
External supply	
Voltage:	110...240 V AC +10 % / -15 %, 50/60 Hz
Power consumption:	max. 6 W
Connection:	with screw terminals: 0,5...4 mm ² solid and stranded wire without ferrule 0,5...2,5mm ² stranded wire with ferrule Max. tightening torque: 0.8 Nm
Total power loss:	max. 3 W
Response to bus voltage failure:	depending on parameterization (cf. chapter 4. "Software description")
Response to bus voltage failure	As per parameterization, the device can report the supply voltage failure to the bus. Afterwards, the device will completely shut down.
Response to bus voltage return:	depending on parameterization (cf. chapter 4. "Software description")
Response to mains voltage return:	The device will briefly initialize (" - - " display) and is then ready for operation. As per parameterization, the device can report the return of supply voltage to the bus. The brightness of a DALI group depends on the parameterization (cf. Chapter 4. "Software description").

DALI:

Voltage:	typically 16 V DC with over-voltage protection
Current:	typically 128 mA, max. 200 mA temporarily designed for a maximum of 64 DALI devices at 2 mA with short-circuit and overload protection
Transmission rate	1200 bit/s
Protocol:	acc. to DIN EN 60929 appendix E4
Cable lengths between Gateway and device:	
\varnothing 1,5 mm ²	max. 300 m
\varnothing 1,0 mm ²	max. 238 m
\varnothing 0,75 mm ²	max. 174 m
\varnothing 0,5 mm ²	max. 116 m
Resistivity:	max. 4 Ω (single length) / max. 8 Ω (main and return cable)
Cable type:	Specified by functional extra-low voltage. (FELV) / Preferably 2 free wires of a NYM installation line.

4 Software description

4.1 Software specifications

ETS search paths: - Illumination / Dimmer / DALI Gateway
 BAU used: TPUART + μ C
 KNX/EIB type class: 3b - device with cert. PhL + stack
 Configuration: S-mode standard
 PEI type: "00"_{Hex} / "0"_{Dec}
 PEI connector: no connector

Applications:

No.	Summarized description:	Name	Version	Executable from mask version
1	Multi-functional control of up to 32 DALI groups with adjustable dimming response, time functions, scenes, disable function or forced-control position, Soft-ON or Soft-OFF functions and extended feedback. Centralized switching of all outputs is also available. In addition, the brightness values of the DALI groups can be separately adjusted in case of bus voltage failure or return or after programming with the ETS.	DALI Gateway C00C02 EN	0.2 (english) for ETS 3.0 Versions a...c	705
		DALI Gateway C00C12 EN	1.2 (english) for ETS3.0 from version d onwards	
2	<u>This application program is recommended.</u> Multi-functional control of up to 32 DALI groups with adjustable dimming response, time functions, scenes, disable function or forced-control position, Soft-ON or Soft-OFF functions and extended feedback. Centralized switching of all outputs is also available. In addition, the brightness values of the DALI groups can be separately adjusted in case of bus voltage failure or return or after programming with the ETS. Difference to version 0.2 / 1.2: Extended function when commissioning the DALI. Optional assignment of one DALI-device to only one group or, alternatively, a multiple assignment.	DALI Gateway C00C04 EN	0.4 (english) for ETS 3.0 Versions a...c	705
		DALI Gateway C00C14 EN	1.4 (english) for ETS3.0 from version d onwards	

4.2 "DALI Gateway C00CX2 EN / C00CX4 EN" software

4.2.1 Scope of functions

General:

- Control of a maximum of 64 DALI devices in a max. of 32 groups.
- Manual control of the groups independent of the bus (site operation with broadcast control).
- Feedback of DALI error status or short-circuit and supply voltage failure message.
- Central switching function.
- Incorporation of the groups into up to 16 light-scenes possible.

Channel-oriented:

- Each group features the full scope of functions without any restrictions. All channel-oriented functions can be parameterized separately for each group. This feature permits independent and multi-functional control of the DALI devices. However, the Staircase timer function can only be parameterized for groups 1 ... 16.
- Switching feedback and brightness value: active (after changes or cyclical transmission to the bus) or passive (object read-out function) feedback function.
- Adjusting the limit values for brightness is possible.
- Dimming response can be parameterized.
- Soft-On or Soft-Off function.
- Disable function or, alternatively, forced-control position function can be parameterized for each group. With the disable function, blinking of lighting groups is possible.
- Timer functions (ON-delay, OFF-delay, staircase lighting function, also with pre-warning function).
- Response to bus voltage failure and bus voltage return as well as after ETS programming can be adjusted for each group.

Plug-in:

- Convenient DALI commissioning without additional software components.
- Test function for all created DALI groups or DALI devices: central ON/OFF switching, individual hardware check (ON / OFF, brightness value preset, device status), individual group check (switching, dimming) and scene check.
- Export and import of preset parameters in XML format.
- Printing function for creating a configuration report (overview of group assignments or of the entire device configuration).

4.2.2 Software information

ETS project design and commissioning

For creating a project and for the commissioning of this device it is recommended to use the ETS3.0d version. Advantages with regards to downloading (significantly shorter loading times) can be expected only if this ETS patch version or later versions are used. The advantages result from the use of the new mask version 7.5 and the ETS3 support.

The product database required for the ETS3.0d is offered in the *.VD4 format. The corresponding application program has the version number "1.2" or "1.4". For older versions of the ETS3 a separate product database is available in the *.VD2 format. The application program for these ETS versions is version "0.2" or "0.4".

The two application programs differ in terms of the functional range described in this documentation.
Explanation:

In principle, it is also possible to assign a DALI device to several groups during the DALI commissioning. In order to simplify the device assignment, the ETS application program of version "0.4" or "1.4" provides in the plug-in the option to prevent an assignment of DALI devices to several groups. This makes the device assignment easier and more clearly. Alternatively, an assignment of devices to several groups can be permitted, if required.

The application program of version "0.2" or "1.2" always allows the DALI devices to be assigned to several groups. It is recommended to use the application program of version "0.4" or "1.4" when configuring the device in the ETS.

When older ETS versions are updated to the level of version ETS3.0d or to that of later versions, an additional tool in the form of an ETS add-in is available. This tool is capable of converting older product databases of application version "0.2" or "0.4", for instance from existing ETS2 projects, into the new application format (version "1.2" or "1.4"). This feature permits making use of the advantages of the ETS3.0d application in an easy way and without creating any changes to the project design. The ETS3 add-in can be obtained separately from the manufacturer and is free of charge.

Safe-state mode

If the device - for instance as a result of errors in the project design or during commissioning - does not work properly, the execution of the loaded application program can be paused by activating the safe-state mode. In the safe-state mode, the outputs cannot be controlled via the bus. A manual control for broadcast is the only feature that can be activated. The Gateway remains passive in safe-state mode since the application program is not being executed (state-of-execution: terminated). Only the system software is still functional so that the ETS diagnosis functions and also the programming of the device continue to be possible.

Activating safe-state mode

- Disconnect the mains voltage supply.
- Press the programming key and keep it pressed.
- Switch on the mains voltage supply. Release the programming key only after the programming LED starts blinking slowly.

The safe-state mode is now activated. With another brief press on the programming key, the programming mode can be switched on and off as usual also in the safe-state mode. The programming LED will nonetheless continue to blink independent of the programming mode as long as the safe-state mode remains active.

- ❗ The safe-state mode can be terminated by switching off the mains voltage supply or by programming with the ETS.
- ❗ For the activation of the safe-state mode, the bus voltage does not have to be switched on.



Unloading the application program

The application program can be unloaded via the ETS. In this case, only manual control is possible for the broadcast of connected DALI devices.

4.2.3 Object table

Number of communication objects:	216
Number of addresses (max):	254
Number of assignments (max):	255
Dynamic table management:	no
Maximum table length:	255

Objects affecting several channels:

Function: Scenes					
Object	Function	Name	Type	DP type	Flag
 208	Extension unit	Scenes	1-byte	18.001	C, W, -, (R) ¹
Description: 1-byte object for recalling scenes or for storing new scene values.					
Function: DALI fault and performance monitoring					
Object	Function	Name	Type	DP type	Flag
 210	Feedback	DALI error status	1-byte	---	C, W, T, (R) ^{1 2}
Description: 1-byte object for transmitting the error status of DALI devices that are connected individually to the system to the bus. The following bit assignment is used: Bit 0...5: number of the DALI device (0...63) Bit 6: lamp error (0 = no error, 1 = error) Bit 7: electronic ballast error (0 = no error, 1 = error) Independent of the feedback parameter setting, this object can always receive telegrams (ValueWrite) as a transmission request. A received telegram will be immediately answered via this object (ValueWrite) by transmitting the current internal object status. Bits 0...5 in a request telegram must include the number of the DALI device. Bits 6 and 7 have to be set to "1". Otherwise, the request telegram will be ignored.					

¹ Each communication object can be read-out. The readout requires the setting of the R flag.

² Depending on the parameterization the feedback objects are either actively transmitting (T flag) or can be passively read-out (R flag).

Function: DALI monitoring

Object	Function	Name	Type	DP type	Flag
 211	Message	DALI voltage failure	1-bit	1.005	C, -, T, (R) ¹

Description: 1-bit object for reporting a mains voltage failure at the DALI Gateway.
(mains voltage available = 0, mains voltage failure = 1)

Function: DALI monitoring

Object	Function	Name	Type	DP type	Flag
 212	Message	DALI short-circuit	1-bit	1.005	C, -, T, R ¹

Description: 1-bit object for reporting a short-circuit in the DALI line.
(no short-circuit = 0, short-circuit = 1)

Function: Central function

Object	Function	Name	Type	DP type	Flag
 213	Switching	Central function	1-bit	1.001	C, W, - (R) ¹

Description: 1-bit object for the central switching of assigned DALI groups. The polarity can be parameterized.

Function: Manual control

Object	Function	Name	Type	DP type	Flag
 214	Disable	Manual control	1-bit	1.003	C, W, - (R) ¹

Description: 1-bit object for disabling the keys for manual control on the device. The polarity can be parameterized.

Function: Manual control

Object	Function	Name	Type	DP type	Flag
 215	Status	Manual control	1-bit	1.002	C, -, T, (R) ¹

Description: 1-bit object for the status transmission of manual control. The object is "0", when manual control is deactivated (bus mode). The object is "1", when manual control is activated. The user can determine whether the temporary or the permanent manual control will be displayed as status information.

¹ Each communication object can be read-out. The readout requires the setting of the R flag.

Channel-oriented objects:

Function: Output switching					
Object	Function	Name	Type	DP type	Flag
☐← 0, 7, 14, ..., 105 112, 118, ..., 202	Switching	Group 1 ... 32	1-bit	1.001	C, W, -, (R) ¹
Description: 1-bit object for switching a DALI group on or off ("1" = switching on; "0" = switching off).					
Function: Output relative dimming					
Object	Function	Name	Type	DP type	Flag
☐← 1, 8, 15, ..., 106 113, 119, ..., 203	Dimming	Group 1 ... 32	4-bit	3.007	C, W, - (R) ¹
Description: 4-bit object for the relative dimming of a DALI group.					
Function: Output absolute dimming					
Object	Function	Name	Type	DP type	Flag
☐← 2, 9, 16, ..., 107 114, 120, ..., 204	Brightness value	Group 1 ... 32	1-byte	5.001	C, W, - (R) ¹
Description: 1-byte object for setting an absolute dimming value (brightness value 0...255) by the bus.					
Function: Absolute dimming feedback					
Object	Function	Name	Type	DP type	Flag
☐← 3, 10, 17, ..., 108 115, 121, ..., 205	Brightness value feedback	Group 1 ... 32	1-byte	5.001	C, -, T, (L) ^{1 2}
Description: 1-byte object for transmitting feedback of an adjusted dimming value (brightness value 0...255) to the bus.					
Function: Switching feedback					
Object	Function	Name	Type	DP type	Flag
☐← 4, 11, 18, ..., 109 116, 122, ..., 206	Switching feedback	Group 1 ... 32	1-bit	1.001	C, -, T, (R) ^{1 2}
Description: 1-bit object for transmitting feedback to the bus signalling the switching state ("1" = switched on / "0" = switched off).					

¹ Each communication object can be read-out. The readout requires the setting of the R flag.

² Depending on the parameterization the feedback objects are either actively transmitting (T flag) or can be passively read-out (R flag).

Function: Staircase timer function ³

Object	Function	Name	Type	DP type	Flag
 5, 12, 19, ..., 110	Staircase timer function start/stop	Group 1 ... 16	1-bit	1.010	C, W, -, (R) ¹

Description: 1-bit object for activating or deactivating the switching time of the Staircase timer function of an output ("1" = on / "0" = off).

Function: Disable function

Object	Function	Name	Type	DP type	Flag
 6, 13, 20, ..., 111 117, 123, ..., 207	Disable	Group 1 ... 32	1-bit	1.003	C, W, - (R) ¹

Description: 1-bit object for disabling a group (polarity is parameterizable).

Function: Forced-control position function

Object	Function	Name	Type	DP type	Flag
 6, 13, 20, ..., 111 117, 123, ..., 207	Forced-control position	Group 1 ... 32	2-bit	2.001	C, W, - (R) ¹

Description: 2-bit object for the forced-control position of a group. The polarity will be provided by the telegram.

³ The Staircase timer function can only be parameterized for the first 16 groups.

¹ Each communication object can be read-out. The readout requires the setting of the R flag.

4.2.4 Functional description

4.2.4.1 Application basics

DALI

The DALI Gateway represents the interface between a KNX/EIB building installation and a digital DALI (Digital Addressable Lighting Interface) lighting system. Normally, all DALI systems are room-oriented and deal with the high demands on functional light management in, for example, offices, training and conference rooms. Often, these applications make it necessary to incorporate the room-oriented DALI system also into the KNX/EIB facility management across buildings. That makes it possible not only to control the DALI lighting system via the sensor components of the KNX/EIB but also to incorporate the shutter, heating and air conditioning systems already existent in the buildings into the light management.

A DALI system can address a maximum of 64 devices. The Gateway itself does not count as a device. The DALI Gateway offers 32 KNX/EIB controllable groups that are parameterized in the ETS 3 similar to a dimming actuator channel. There are several communication objects available at the bus that permit, among other things, the switching, the dimming, the setting of brightness values or the time or scene control of a group. During the DALI commissioning, the DALI devices (max. of 64) will be optionally assigned one or several groups of the Gateway (cf. figure 5 on the following page). It is the group assignment that makes it possible to control the DALI devices individually (individual assignment – only one device in the group) or collectively (multiple assignment – several devices in a group) via the KNX/EIB.

A multiple assignment of DALI devices is possible for the groups 1...16 of the DALI Gateway. In this case the addressing takes place at the DALI via group addresses that the DALI Gateway configures "hidden" to the user. The DALI Gateway handles them independently. During the DALI commissioning, all affected devices will be automatically programmed. The groups 17...32 accept only individual assignments. Each group can be assigned only one DALI device. In this case, the DALI addressing takes place via an internally specified individual address. Only one device can be uniquely addressed via this individual address. This individual address will also be automatically assigned by the DALI Gateway during the DALI commissioning.

The DALI commissioning takes place entirely via the plug-in embedded in the ETS 3 via the KNX/EIB bus line. No additional tool and no special programming link is required. The commissioning of the DALI devices as well as the DALI configuration or the DALI addressing takes place fully automatic via the plug-in and the DALI Gateway. Only the assignment between the DALI device and the group must be carried out 'manually' in the commissioning environment of the plug-in. Different test or detection functions (separate switching on, switching off or blink function) available in the plug-in make it also considerably easier to commission the different DALI devices.

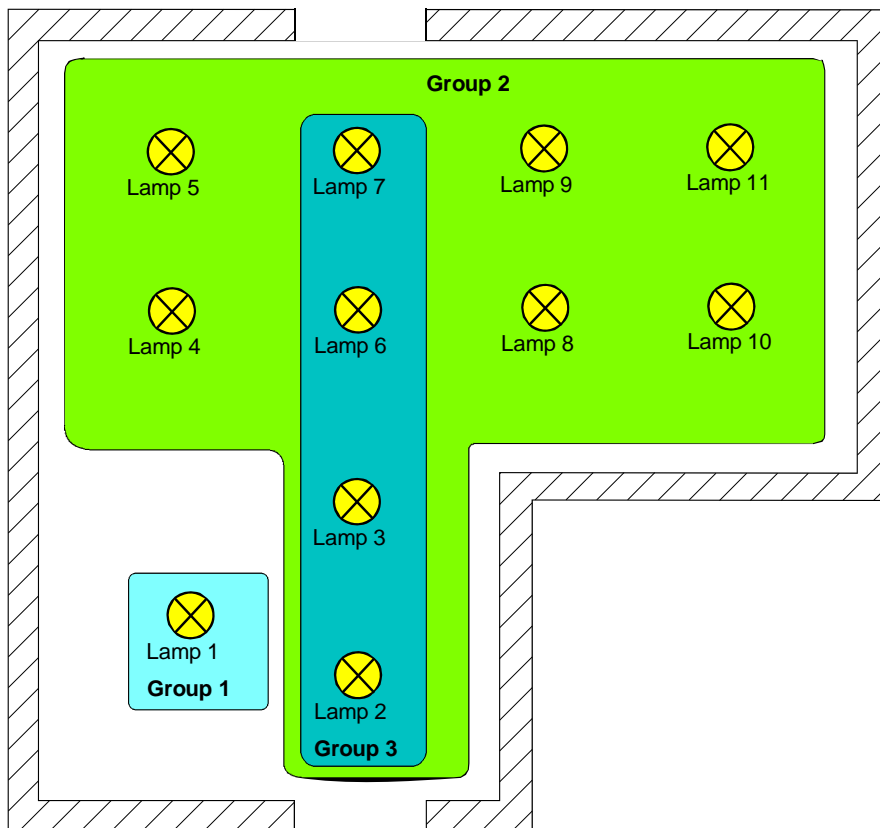

Figure 5: Example of a grouping in the DALI system

In the example of a grouping (cf. Figure 5) each one of the drawn-in lamps features a DALI device which is assigned one or several groups. In the example, lamp 1 is part of an individual group. This lamp can be controlled separately from the other lamps. The other lamps belong to group 2. Hence, they are collectively controlled. In addition, the lamps 2, 3, 6 and 7 can be controlled via group 3. Thus, groups 2 and 3 assigned to these lamps overlap.

i DALI devices that are assigned several groups will always adjust to the state that has been adjusted last via one of the assigned groups. In this case, the feedback of the switching status or the brightness value of a group is not always unique.

Example 1(cf. Figure 5): Group 2 is set to 10% brightness. Group 3 is then dimmed to a brightness value of 20%. The lamps of group 3 will accept the brightness value of 20% which was invoked last. The feedback of group 2 remains on 10% although some of the devices belonging to the group have been set to 20% brightness.

Example 2: group 2 is switched on and assumes the brightness value of 100%. Internally, the state of group 3 remains set at 0% brightness (OFF). The brightness of group 3 is now increased. The lamps of group 3 will adapt to the dimming (increasing brightness starting at minimum brightness) even though these lamps have already been switched on via group 2.

Basically, the assignment of DALI devices to groups is arbitrary. For the reasons mentioned above it is recommended not to assign the devices to several groups at the DALI. In this case, the multiple assignment can be turned off in the plug-in if the application program of version "0.4" or "1.4" is used for the ETS configuration. Preferably, the devices should be allocated to separate instead of overlapping groups. A KNX/EIB link via the group addressing in the ETS is also preferred.

The DALI Gateway acts as the central control component (master-controller) in the system that also ensures the power supply of the DALI interface. The DALI devices, e.g. DALI electronic ballast, function as slaves that transmit back the states or status reports to the master only upon request. It is the function of the DALI Gateway only to transmit control commands received by the KNX/EIB to the DALI line as well as to control the devices. Further DALI control components in multi-master mode, e.g. an additional DALI center, a DALI potentiometer or power switching pushbuttons, are unnecessary and can lead in some individual cases to malfunction in the DALI system. Therefore, it is necessary to remove other control components from the system – especially when refitting existing DALI systems. The DALI system is then entirely controlled by components of the KNX/EIB (cf. figure 6).

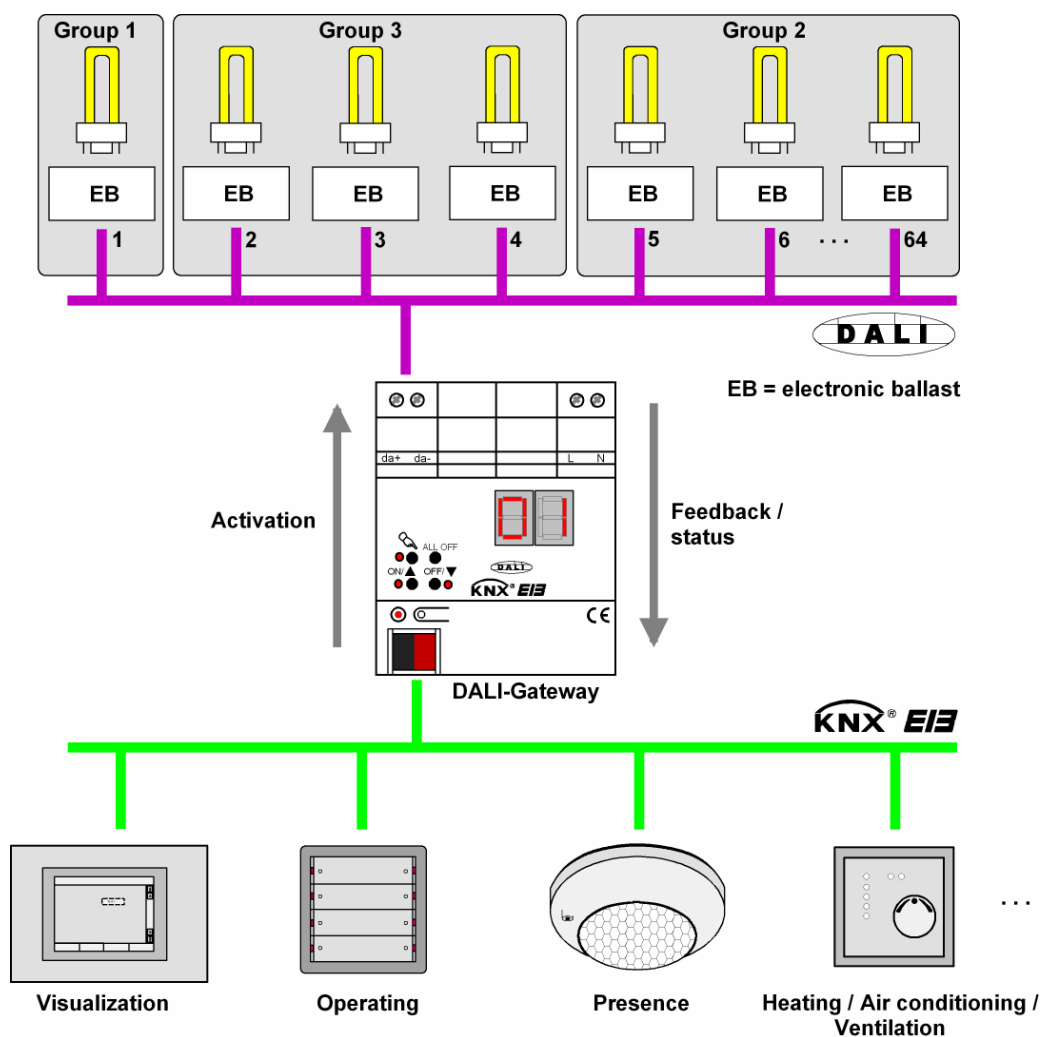

Figure 6: Schematic diagram of a KNX/EIB-DALI system interconnection (example: DALI electronic ballast in different groups)

The communication via the DALI Gateway between the KNX/EIB and the DALI interface is bi-directional. On the one hand, the Gateway receives telegrams from the KNX/EIB that either directly influence the brightness status of a DALI group (e.g. by switching, dimming, setting the brightness value or scene recall) or indirectly adjust it (e.g. via time, disable or forced-control position functions). Thus, the DALI Gateway internally always detects the current brightness states of the groups and forwards brightness commands to the DALI devices which will then adjust to the corresponding brightness.

On the other hand, the internally tracked switching or brightness states of the groups can be reported back to the KNX/EIB. The transmission of status information of the DALI devices (lamp error, electronic ballast error) or the Gateway (mains voltage failure, DALI short-circuit) to the bus is possible.

In addition, all groups controllable by up to 32 KNX/EIBs can be integrated in 16 independent scenes. In a scene, brightness values can be separately parameterized for each DALI group in the ETS. They can also be adjusted any time later during the on-going operation.

i If the DALI devices have been assigned several groups (overlapping groups) and if these groups have been assigned a common scene, the devices will adjust to the brightness value of the group with the highest number.

Example: An electronic ballast device has been assigned groups 1 and 2. Both groups have been assigned scene 1. When recalling a scene, group 1 is to adjust to a brightness of 10 % and group 2 to 20 %. If scene 1 is recalled the electronic ballast device is adjusted to 20 % brightness since group 2 has the higher group number.

ETS plug-in

The setting of all device parameters as well as the DALI commissioning takes place entirely via the plug-in embedded in the ETS 3. The plug-in is part of the product database and will be automatically installed when the product file is imported into the ETS database. That makes the installation of an additional software unnecessary.

The plug-in is started by including the DALI Gateway in an ETS 3 project and by opening the parameter view of this device. Afterwards, the ETS programmer will have the view shown in figure 7.

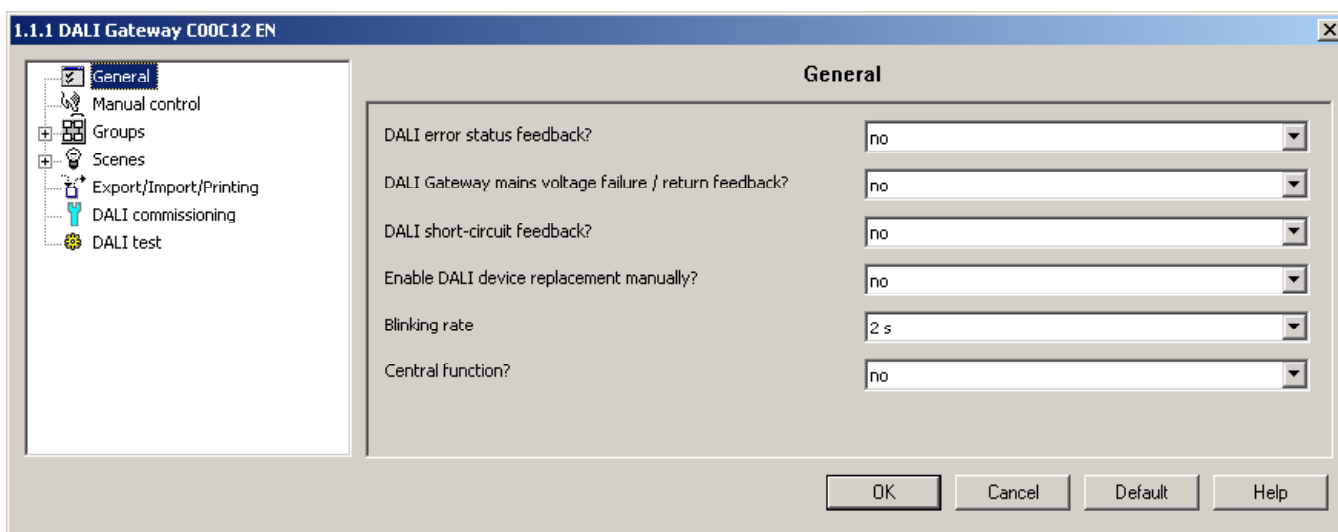

Figure 7: Project interface of the ETS 3 plug-in

The project-interface is derived from the general ETS 3 parameter view and is divided into the same fields. The tree structure in the left subwindow displays all parameter pages of the parameters affecting several channels and devices as well as the group related parameters. The window also displays the pages with the options for the commissioning and the import/export function.

The individual pages can be selected and opened with mouse-clicks or via keyboard navigation. The parameters assigned to the parameter page or the options for the commissioning will become visible in the right subwindow.

There are 4 buttons located in the lower window section. The "OK" button will close the plug-in and save the selected parameters and configurations in the ETS database.

The "Cancel" button will close the plug-in without saving the data into the ETS database. Any changes made to the parameter settings will be lost. Previously set DALI commissioning parameters will also not be accepted into the ETS database. However, a DALI commissioning that has been executed before will remain in the DALI devices.

The "Default" button will restore the default values. All changes made to the parameter settings that differ from the default settings will be discarded. All created groups will be deleted. The DALI commissioning parameters are also affected. The assignment of DALI devices to groups will get lost. However, a DALI commissioning executed before will remain in the DALI devices if the "Default" button is not activated in the commissioning environment. For this reason, a new DALI commissioning should always be carried out.

By activating the "Help" button this DALI Gateway product documentation will open as an online help page.

Handling DALI groups:

The DALI Gateway can distinguish up to 32 different groups which are created and configured separately. Group 1 has already been created in the start view of the plug-in. Additional groups can be added by selecting "Groups" in the tree structure view followed by the "New" command via the context menu (right mouse click) (cf. Figure 8).

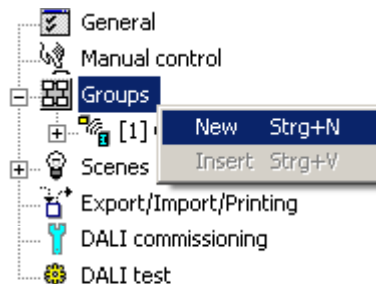

Figure 8: Adding DALI groups

Any created group can also be copied via the "Copy" command in the context menu of a group node and inserted as a new group in the "Groups" node. The parameter settings of the copied group will be adopted.

It is also possible to insert a previously copied group into an already existing one. All parameter settings of the existing group will be adopted by the copied group.

Each created group receives a unique group number that is shown in square brackets in front of the group name. The group number will be shown in the 7-segment display on the front panel when manual control has been activated.

Created groups can be deleted at any time by selecting a group followed by the "Delete" command in the context menu. It should be noted that at least one group must have been created.

Each group can be assigned a name by selecting a group followed by the "Rename" command via the context menu. It is recommended to assign a unique name to each group (e.g. "Light-band window South", "Spots office center", etc.). The name may not exceed 28 characters and may include alphanumerical as well as special characters.

i Each group can be parameterized independently in the plug-in. During the DALI commissioning, the individual DALI devices will be programmed with the parameterization data once the group parameterization has been completed. All devices assigned to a DALI group will be identically put into operation.

If, however, DALI devices have been assigned to several groups, these devices will receive the project design with the highest group number.

Import, export, printing:

The project design of the device (all parameter settings and KNX/EIB group addresses) as well as all DALI commissioning parameters (all detected DALI devices and group assignments) can be backed up by exporting an external XML file. Backed up data can be imported at any time. That way it is easy to back up data 'outside' the ETS database as well. In addition, an existing project design can also be imported into other DALI Gateways as a master which makes it considerably easier to configure a new device.

The import and export function can be executed on the "Import / Export / Printing" parameter page of the plug-in.

By activating the "Export" button, the current device configuration of the plug-in will be exported into an XML file. The memory location for the file can be specified prior to the export. The plug-in displays the progress during the export. This may take some time. The time required depends on the number of existing DALI devices and the number of the created groups and enabled functions.

i The data is exported in an *"*.XML"* format. In order to export an XML file, the Microsoft XML parser 4.0 must be installed on the PC ("msxml4.dll"). The program can be downloaded on the Microsoft homepage (www.microsoft.com/downloads) for operating systems from Windows 98 onwards (search term "msxml"). The required program package is "MSXML 4.0 Service Pack 2 (Microsoft XML Core Services)" or a later version.

In case the program package is not installed, the plug-in of the DALI Gateway will report an error when executing an export command. More recent operating systems come with the program package already preinstalled.

Activating the "Import" button will import a previously exported XML file into the device configuration. It should be noted that the current configuration of the plug-in including the commissioning parameters of the DALI devices will be overwritten in the ETS by the import. The plug-in will display a warning message before proceeding with the import (cf. Figure 9).

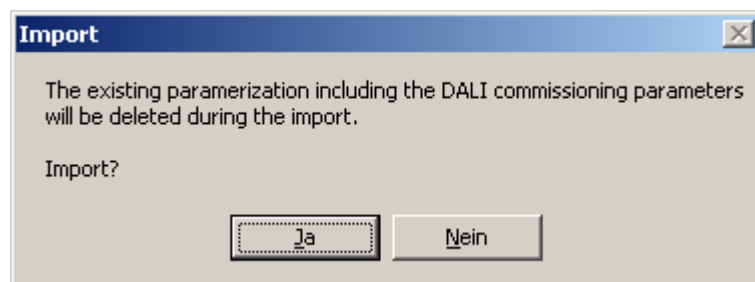

Figure 9: Warning message prior to the import

After the import has been confirmed the plug-in will ask whether the import is to take place with or without KNX/EIB group addresses (cf. figure 10).

When importing without group addresses the plug-in will not transfer any associations between communication objects and group addresses of the XML file. Objects are not associated with any group addresses after the import.

It is also possible to import a XML file with the KNX/EIB group addresses stored in the file. Before transferring, the plug-in will check all group addresses stored in the XML file. The plug-in will discard the group addresses if they have either not been created in the current ETS project or if (in case they are available) are of the wrong data type.

- i** If an XML import with transfer of the group addresses is used on a device that has already been preconfigured with group addresses in an ETS project, the following must be taken into consideration:
Group addresses are not transferred completely from the XML template if group addresses are already linked with communication objects! In this case all group addresses in the device in question must be deleted in the ETS project before the XML import. Only after that can the XML import with group addresses be performed.
- i** After each successful XML import with group addresses, the "Sending" flags of the addresses must be adapted "by hand". This adaptation must be performed separately for each communication object in the ETS configuration view with a closed plug-in. Setting the "Sending" flag configures in the ETS the group address an object uses to transmit telegrams actively to the bus (transmitting address). Only one address of a given object can be transmitting. All other addresses are exclusively receiving. During an XML import, the plug-in automatically sets the address with the highest value as transmitting

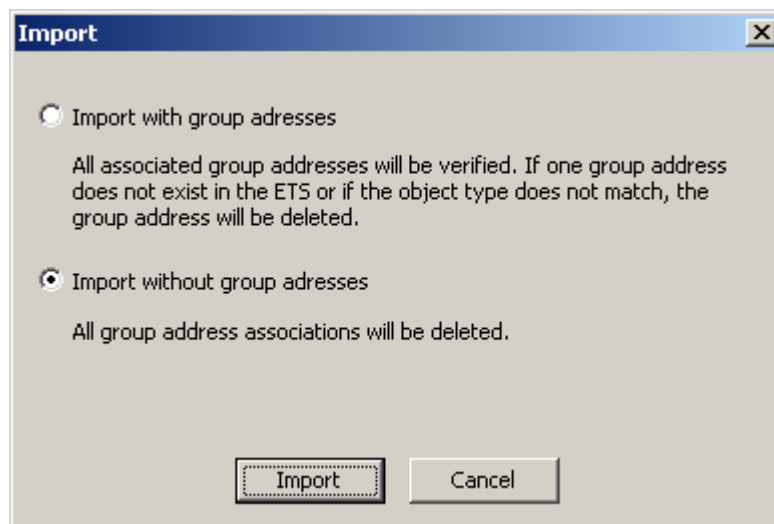

Figure 10: Import dialogue with or without KNX/EIB group addresses

- i** The import will also overwrite all DALI commissioning parameters (detected DALI devices and group assignments) with the data of the XML file. It must be pointed out that only the data stored in the ETS database will be adjusted. A prior DALI commissioning including the programming of the DALI devices will remain in the DALI devices. For this reason, a new DALI commissioning should always be carried out after the import of an XML file.

The plug-in of the DALI Gateway also permits the printing of the entire device configuration including the project design of the groups, the scene configuration and all DALI commissioning parameters in form of a configuration report.

The print function can be found on the "Import / Export / Printing" parameter page of the plug-in.

After activating the "Print" button, the plug-in will ask whether you want to print the complete device configuration or only part of the DALI commissioning parameters including the DALI group assignments (cf. figure 11).

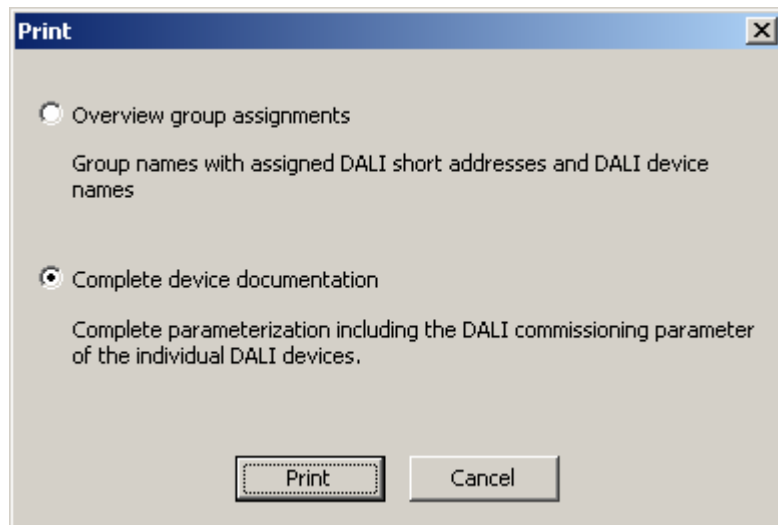

Figure 11: Print dialogue for selecting printing options

The project design of the DALI groups, the DALI commissioning and the DALI test are described in the following chapters.

4.2.4.2 Functions affecting several devices

Feedback for DALI error status

The DALI Gateway permits the error status feedback of the connected DALI devices. In case of failure, the DALI components will send "lamp error" or "Error in device (e.g. electronic ballast error)" status information to the DALI Gateway where it will be stored. The DALI Gateway provides all status information via the "DALI error status" 1-byte collective feedback object 210 on the KNX/EIB side.

The data format of the collective feedback object is described in table 1.

Bits							
7 (MSB)	6	5	4	3	2	1	0 (LSB)
Number of DALI device (0...63)							
Lamp error (0 = no error, 1 = error)							
Device error, e.g. internal electronic ballast error (0 = no error, 1 = error)							

Table 1: Data format of the collective feedback object for DALI error status.

A feedback telegram will always transmit the status information of only one DALI device.

The bits 0...3 of the 1-byte feedback telegram identify the faulty device via the device number. The numbers of all DALI devices are shown in square brackets in front of the device name in the commissioning environment of the ETS plug-in or in the configuration report (print function) (e.g. [1] for the first DALI device). By assigning a meaningful device name during the commissioning in addition to the number (e.g. "[1] electronic ballast row 1 right"), it will be easy to identify which device at what location actually is reporting the error. The device numbers will be automatically assigned during the commissioning when searching for existing devices.

i It has to be noted that the device number found in the plug-in or printed in the documentation is counted in decimals from 1 to 64. The numbers given in the feedback telegram are equivalent from 0 to 63.

Bit 6 will be set in the feedback telegram if the applicable DALI device has detected a lamp error (e.g. defect lamps, cable break to the lamp socket). In case of no lamp defect this bit is deleted ("0").

Bit 7 of the feedback will be set if the identified device has reported a general error (e.g. internal electronic ballast error) or if the applicable device can no longer be addressed via the DALI Gateway (e.g. the device is disconnected from the DALI line). In case of no device error this bit is deleted ("0").

As the master in the DALI system, the DALI Gateway will request periodically every second the status of the connected devices (slaves) as soon as it is ready for operation. That means that in a system with a maximum of 64 DALI devices, an error will be identified no later than after 64 seconds. An error occurring in the device has to be eliminated (switch off mains voltage at the relevant DALI device and follow the manufacturer's guidelines!). The DALI Gateway will automatically detect an eliminated error after the commissioning of the repaired device and will remove the error status in the feedback.

Setting the feedback for the DALI error status

The ETS parameterization allows to define whether the error status feedback is to be transmitted actively to the KNX/EIB (telegram transmission when status has changed) or passively (telegram transmission only in case of a trigger request).

- Set the "DALI error status feedback ?" parameter on the "General" parameter page to "Yes, feedback object is an active message object".

As soon as an error has been detected at a DALI device during the cyclical status request, the DALI-Gateway will send a feedback telegram with the corresponding device number to the KNX/EIB.

As soon as an error at the DALI device has been eliminated, the DALI-Gateway will detect the elimination of error as long as the operating voltage supply had been available without any interruptions and it will send, corresponding to the DALI device number, a feedback telegram "No error" to the KNX/EIB.

This is where the behaviour of the DALI-Gateway depends on the device version. The difference can be explained as follows...

In case of devices showing the version identification "I01" on the device label, another feedback telegram will be directly transmitted to the KNX/EIB when an eliminated error has been acknowledged provided that at least one more DALI error was detected by the Gateway. This ensures that further DALI errors can be immediately detected by the operating or maintenance personnel, for example, with visualization. If no other device or lamp error has been detected, no other feedback telegram will be send by the Gateway.

In case of a DALI Gateway without the version identification on the device label mentioned above, further identified errors will not be sent again to the KNX/EIB during the elimination of a device or lamp error. The transmission of a feedback telegram relating to a DALI device is thus taking place only once in each case after the error has been detected.

- ❗ An stored error in the DALI Gateway will get lost in case of a mains voltage failure. Thus, no more feedback will be transmitted once an error has been eliminated by switching off and on again the mains voltage at the DALI Gateway.
- ❗ The DALI Gateway initializes after the programming of the ETS or after the mains voltage has been switched on. If a DALI error has been detected the Gateway will proceed to transmit the corresponding feedback telegram. The "DALI error status" will not be automatically transmitted to the bus after the return of bus voltage (mains voltage at the Gateway is permanently switched on during bus failure).

- Set the "DALI error status feedback ?" parameter on the "General" parameter page to "Yes, feedback object is a passive status object".

In case of a detected error there will be no automatic telegram transmission to the KNX/EIB. In order to determine the error status of a DALI device, the "DALI error status" communication object 210 has to be externally written by a 1-byte trigger telegram (ValueWrite). The bits 0...5 of the trigger telegram have to include the number of the DALI device whose status has been requested (cf. Table 1). The bits 6 and 7 have to be set to "1". Otherwise the trigger telegram will be ignored. The DALI Gateway will immediately respond to a received and valid trigger telegram by transmitting the current status once.
- ❗ The Gateway will respond with deleted error bits to trigger requests for device numbers that are not available in the DALI system.
- ❗ The DALI Gateway will respond to a Read telegram (ValueRead) that has been transmitted to the "DALI error status" communication object 210 by sending the object value that was updated last (ValueResponse). Thus, DALI devices cannot be uniquely addressed.
- Set the "DALI error status feedback ?" parameter on the "General" parameter page to "No".

This will deactivate the DALI error status. The communication object is now hidden.

Feedback for the mains voltage supply on the DALI Gateway

The DALI Gateway is able to monitor its supply voltage at the connection. In case of failure the Gateway is able to send a message telegram to the KNX/EIB before shutting down. Optionally, it is possible to have the mains voltage supply confirmed.

If the mains voltage supply of the Gateway and the connected DALI devices are connected to the same phase connector, it is possible to monitor the operating status of the entire DALI system by analyzing the feedback of the mains voltage.

The DALI Gateway uses the independent "DALI voltage failure" 1-bit communication object 211 for giving feedback to a voltage drop or return of voltage. The polarity of the telegram is preset: (mains voltage available = 0, mains voltage failure = 1).

Setting the feedback for the mains voltage supply

The ETS parameterization allows to define whether only a mains voltage supply failure of the DALI Gateway or whether a mains voltage return is also to be reported to the KNX/EIB. The telegram is always actively transmitted. As soon as the status of the mains voltage has changed, a one-time feedback telegram will be transmitted.

- Set the "DALI Gateway mains voltage failure / return feedback ?" parameter on the "General" parameter page to "Yes (only in case of a voltage failure)".
As soon as a mains voltage failure has been detected at the DALI Gateway, the Gateway will immediately transmit a feedback telegram. Then it will shut down.
 - Set the "DALI Gateway mains voltage failure / return feedback ?" parameter on the "General" parameter page to "Yes (only in case of voltage failure and return)".
As soon as a mains voltage failure has been detected at the DALI Gateway, the Gateway will immediately transmit a feedback telegram. Then it will shut down. The DALI Gateway initializes when switching on the mains voltage supply. It will then transmit a feedback telegram and indicate that the mains voltage is on.
 - Set the "DALI Gateway mains voltage failure / return feedback ?" parameter on the "General" parameter page to "No".
The feedback mains voltage supply status will be deactivated. The communication object is now hidden.
- i** Feedback on a mains voltage failure can only be transmitted if the bus voltage has been connected and switched on at the time of the failure.
In case no bus voltage has been connected or switched on at the time of the voltage return, there will be also no feedback on the mains voltage return. The feedback will not be stored. Thus, no feedback will be transmitted even at a later time when switching on the bus voltage.
- i** The "DALI voltage failure" feedback is not automatically transmitted to the bus after the return of bus voltage or after ETS programming with bus voltage applied at the DALI Gateway.

Feedback for DALI short-circuit

The DALI Gateway detects short-circuits in the DALI line – for instance in case of an installation error. As soon as a short-circuit has been identified in the DALI line (with mains voltage applied), the DALI Gateway will send a feedback to the KNX/EIB if the feedback function has been enabled for a DALI short-circuit.

The DALI Gateway utilizes the independent “DALI short-circuit” 1-bit communication object 212 for a DALI short-circuit feedback. The polarity of the telegram is preset: (no short-circuit = 0, short-circuit = 1)

Setting the feedback for DALI short-circuit

The ETS allows to set parameters that determine whether a DALI feedback on a short-circuit is to be transmitted to the KNX/EIB. If enabled, the telegram is always actively transmitted. If a short-circuit has been detected or eliminated, the Gateway will transmit a feedback telegram in each case.

- Set the "DALI short-circuit feedback ?" parameter on the "General" parameter page to "Yes".
The DALI short-circuit feedback is activated and the communication object is enabled.
- Set the "DALI short-circuit feedback ?" parameter on the "General" parameter page to "No".
The DALI short-circuit feedback function is deactivated. The communication object is hidden.

- ❗ The connected DALI devices will also respond to a short-circuit in the DALI line. The devices will adjust to the preset "SystemFailureLevel". This value will be programmed into the DALI devices during the commissioning of the DALI Gateway and corresponds to the “Response to bus voltage failure” value that can be parameterized in the ETS for each group.
- ❗ Because the brightness of the connected DALI devices might possibly change in case of a short-circuit ("SystemFailureLevel"), the DALI Gateway will also transmit feedback on the switching state and brightness value to the bus if these feedback functions have been enabled.
- ❗ Feedback on a DALI short-circuit can only be transmitted if the bus voltage has been connected and switched on at the time of the short-circuit.
In case no bus voltage has been connected or switched on at the time of the short-circuit, there will also be no feedback transmission. The feedback, however, will be stored so it can be transmitted at a later time after the bus voltage has been applied.
- ❗ The DALI Gateway initializes after the ETS programming or after the mains voltage has been applied. If a short-circuit has been detected in the DALI line, the Gateway will proceed to transmit the corresponding feedback telegram. The “DALI short-circuit” will not be automatically transmitted to the bus after the return of bus voltage (mains voltage at the Gateway is permanently switched on during bus failure).

DALI device replacement

After the start of the automatic device replacement, the DALI Gateway can check the DALI system for the integrity of the DALI devices previously put into operation. If, for instance, the installer has replaced a defect DALI electronic ballast device with a new one, the DALI Gateway is able to program the new electronic ballast device with the project data of the failed electronic ballast device. Thus it is possible to replace a failed DALI device by a simple operation on the device without any complex ETS parameterization.

Chapter 2.4 "Commissioning" describes in detail the automatic device replacement and the required steps to carry out the replacement.

The following describes the ETS parameterization of this function.

Enabling the DALI device replacement

The ETS allows to set parameters that determine whether an automatic device replacement can be carried out locally at the DALI Gateway.

- Set the "Enable DALI device replacement manually?" parameter on the "General" parameter page to "Yes".

This permits to start and carry out an automatic DALI device replacement locally at the DALI Gateway.

- Set the "Enable DALI device replacement manually?" parameter on the "General" parameter page to "No".

An automatic DALI device replacement will now not be possible. Locally, the control function is disabled.

- ❗ All other functions of the DALI Gateway are paused during the automatic device replacement. The Gateway tracks all bus states received during the device replacement and regularly analyzes the values tracked before (switching, dimming, brightness value, scenes, central function, forced-control position, disable function) at the end of the automatic device replacement. The device replacement will interrupt any active forced-control position or disable function which will be activated again at the end of the replacement, if, in the meantime, the functions have not been deactivated via the bus. The behaviour as at the beginning of these functions will not be carried out again.
- ❗ An automatic device replacement can also be carried out if the manual control has been disabled.

Manual control

The DALI Gateway permits to manually control all available DALI groups. The keypad with 4 function keys and 3 status LEDs on the front panel of the device can be used for setting the following modes of operation...

- Bus mode: operation with touch sensors or other bus devices
- Temporary manual control mode: manual operation locally with keypad, automatic return to bus mode,
- Permanent manual control mode: local manual operation with keypad

The operation of the function keys, the control of the outputs and the status indication are described in detail in chapter 2.5 "Operation".

The following paragraphs are to give a more detailed description on the parameterization, status feedback, disabling via bus mode and interactions with other functions of the DALI Gateway with activated and deactivates manual control.

Manual control is possible only if the Gateway is supplied with power from the mains. The DALI Gateway is delivered with fully enabled manual control mode. In this unprogrammed state, all connected DALI devices can be controlled via the broadcast function that permits fast operational testing of the connected drives (e.g. on the construction site).

After the first commissioning of the Gateway with the ETS, the manual control mode can be enabled or disabled separately for different states of operation. Manual control can, for instance, be disabled during bus mode (bus voltage applied). Another option is the complete disabling of the manual control only in the case of bus voltage failure. Therefore, manual control can be completely disabled during the bus mode if bus disable as well as bus failure disable is active.

Enabling the manual control mode

Manual control for the different states of operation is enabled or disabled by means of the "Manual control in case of bus voltage failure" and "Manual control during bus mode" parameters .

- Set the "Manual control in case of bus voltage failure" parameter to "enabled".
Manual control is then basically enabled when the bus voltage is off. This corresponds to the setting in the delivery state.
- Set the "Manual control in case of bus voltage failure" parameter to "disabled".
Manual control is completely disabled when the bus voltage is off. Because bus mode is not available in that state, the DALI groups of the Gateway can no longer be addressed.
- Set the "Manual control during bus mode" parameter to "enabled".
Manual control is then basically enabled when the bus voltage is on. The DALI groups of the Gateway can be operated either via the bus or manually. This setting corresponds to the delivery state.
- Set the "Manual control during bus mode" parameter to "disabled".
Manual control is completely disabled when the bus voltage is on. With this configuration, the DALI groups can only be operated via the bus.

- ❗ A bus voltage failure will not terminate an active manual control even if the “Manual control in case of bus voltage failure = disabled” parameter has been set. It will be disabled only after ending manual control.
- ❗ Other parameters and communication objects of the manual control are visible only with the configuration: "Manual control during bus mode = enabled". For this reason the disable function, the status message and the disabling of the bus mode can only be configured with the above parameter setting in place.

Setting the behaviour for the beginning and for the end of manual control

The manual control features a temporary and permanent manual control mode. These modes cause different behaviours, especially at the end of the control mode. Basically, it should be noted that the bus, i.e. control of the DALI groups by direct control (switching / dimming / brightness value / scene / central) or by the disable or forced-position functions is always disabled in case of an active manual control mode. This is to say that the manual control mode has the highest priority.

Behaviour at the beginning of the manual control:

There is no difference in the behaviour between temporary or permanent manual control at the beginning of the manual control. When activating the manual control, the brightness states of the DALI groups do not change. Blinking during disable function: The blinking of the disable function will be discontinued at the beginning of the manual control. The brightness remains set to the blinking state adjusted last ("ON" or "OFF"). The switching status is indicated by “ON”.

Manual control can override active forced-control positions or disable functions. These functions are reactivated after the manual control mode has been deactivated unless they have been cancelled in the meantime.

Behaviour at the end of the manual control mode:

The behaviour at the end of manual control differs between the temporary and permanent manual control.

The temporary manual control mode is shut off automatically when the last group has been addressed and when the  select key is pressed once more. When the temporary manual control mode is shut off, the Gateway returns to 'normal' bus mode and does not change the brightness states selected by manual control. If, however, a forced-control position or a disable function has been activated via the bus prior to or during manual control, the actuator re-executes these higher-priority functions for the relevant groups.

The permanent manual control mode is shut off, when the  select key is pressed for more than 5 s. Depending on the ETS parameterization of the Gateway, the groups will be set to the state last adjusted in the manual control mode or set to the state internally tracked (direct operation, forced-control position, disable lock) when the permanent manual control is shut off. The "Behaviour at the end of permanent manual control during bus mode" parameter defines the corresponding reaction.

- Set the "Behaviour at the end of permanent manual control during bus mode" parameter to "No change".

All telegrams received during an active permanent manual control for direct operation (switching, dimming, brightness value, central, scenes) will be discarded. After the end of the permanent manual control, the current state of all brightness states remains unchanged. If, however, a forced-control position or a disable function has been activated via the bus prior to or during manual control, the Gateway re-executes these higher-priority functions for the relevant groups.

- Set the "Behaviour at the end of permanent manual control during bus mode" parameter to "Retain outputs".

During an active permanent manual control all incoming telegrams are internally tracked. At the end of the manual control mode, the groups will be set to the brightness states tracked last. If, however, a forced-control position or a disable function has been activated via the bus prior to or during manual control, the Gateway re-executes these higher-priority functions for the relevant groups.
- ❏ The behaviour at the end of the permanent manual control with disconnected bus voltage (only manual control mode) is permanently set to "No change".
- ❏ The control operations triggered in the manual control mode will be transmitted actively via feedback objects to the bus, if enabled.
- ❏ On return of bus voltage or after programming with the ETS an activated manual control mode will always be terminated. In this case, the parameterized or predefined behaviour at the end of manual control will not be executed. Instead, the Gateway will execute the parameterized behaviour upon bus/mains voltage return or after programming with the ETS.

Setting the disable function of the manual control mode

The manual control mode can be separately disabled via the bus, even if it is already active. As soon as a disable telegram is received via the disable object with the disable function enabled, the Gateway will, if applicable, terminate an activated manual control mode immediately and lock the function keys on the device panel. The telegram polarity of the disable object is parameterizable.

The manual control mode during bus mode must have been enabled.

- Set the "Disable function for manual control?" parameter on parameter page "Manual control" to "Yes".

The disable function of the manual control mode has now been enabled and the disable object becomes visible.
- Select the desired telegram polarity for the "Polarity of disable object for manual control" parameter.
- ❏ In case the polarity "0 = disabled; 1 = enabled", the disable function will be immediately active after a bus/ mains voltage return or after an ETS programming (object value "0"). In order to activate manual control, an enabling telegram "1" would have to be transmitted to the disable object first.
- ❏ In case of bus voltage failure, disabling via the disable object is always inactive (depending on parameterization, the manual control is then either enabled or completely disabled). After the return of bus voltage, a disable that had been active before will always be inactive if the polarity of the disable object has not been inverted.
- ❏ In case of supply voltage failure (mains voltage failure), a disable will be deactivated via the disable object.
- ❏ When an active manual control has been terminated by a disable, the actuator will also transmit a "Manual control inactive" status message to the bus, if the status message function is enabled.
- ❏ The disable function of the manual control does not influence the "Automatic device replacement" function.

Setting the status messaging function for the manual control mode

The DALI Gateway can transmit a status message to the bus via a separate object with either activated or deactivated manual control mode. The status telegram can only be transmitted with the bus voltage switched on. The polarity of the status telegram can be parameterized.

The manual control during bus mode must be enabled.

- Set the "Transmit manual control status?" parameter on the "Manual control" parameter page to "yes".
The status messaging function of the manual control is enabled and the status object becomes visible.
 - Specify for the "Function and polarity of status object" parameter whether the status telegram is generally a "1" telegram every time the manual control mode is activated or only in those cases when the permanent manual control is activated.
- i** The status object is always "0", when the manual control mode is deactivated.
- i** The status will be actively transmitted to the bus ("0") only if a manual control that was activated during bus voltage failure has been terminated by the bus voltage return. In this case, the status telegram will be transmitted without delay.
- i** If an active manual control is terminated by a disable, the actuator will also transmit a "Manual control inactive" status telegram to the bus.

Setting a bus mode disable

Individual DALI groups can be disabled locally. The affected groups can then no longer be controlled via the KNX/EIB. A bus mode disable is effected by local control in permanent manual control mode and indicated by the flashing of the group number in the 7-segment display. The disabled groups can then only be addressed in permanent manual control mode.

The manual control during bus mode must be enabled.

- Set the "Bus mode of individual groups can be disabled?" parameter on the "Manual control" parameter page to "yes".
The bus mode disable function is enabled and can be activated locally. If "No" is selected for this parameter, the bus mode disable cannot be activated in permanent manual control mode.
- i** A locally activated disable has the highest priority. Other functions of the Gateway that can be activated via the bus (e.g. forced-control position or disable function) will then be overridden. Depending on the ETS parameterization of the Gateway, the groups will be set to the state last adjusted via manual control or to the state internally tracked (direct operation, forced-control position, disable lock) when the permanent manual control has been enabled and switched off afterwards.
- i** A locally activated bus mode disable will not be reset in case of bus voltage failure or bus voltage return. A supply voltage failure (mains voltage failure) or an ETS programming operation will always deactivate the bus mode disable.

4.2.4.3 Description of functions affecting all channels:

Delay after bus/ mains voltage return

To reduce telegram traffic on the bus line after bus voltage activation (bus reset) or mains supply activation, after connecting the device to the bus line or after an ETS programming, it is possible to delay all actively transmitting feedback telegrams of the Gateway. For this purpose, a delay time affecting all channels can be specified ("Delay after bus voltage return" parameter in the "General" parameter node). Feedback telegrams for bus initialization will be transmitted to the bus only after the parametrized time has elapsed.

Which group-oriented feedback is actually delayed can be specified separately for each DALI group or for each feedback function.

- ❗ The delay has no effect on the behaviour of the individual groups. Only the feedback telegrams will be delayed. The groups can also be activated during the delay after bus voltage return.
- ❗ A setting of "0" for the delay time after bus voltage return will completely deactivate the delay function. In this case, all feedback telegrams, if actively transmitted, will be transmitted to the bus without delay.
- ❗ The "DALI error status", "DALI short-circuit" or "DALI voltage failure" messages will basically be transmitted without time delay.

Delaying a feedback

The transmitting behaviour after a bus voltage return can only be determined for those feedbacks that are enabled and set to actively transmit.

- Set the "Time delay for feedback telegram after bus voltage return" parameter to "Yes". The parameter can be found on the parameter page for the corresponding switching status or brightness value feedback message of a group.

In this case, the feedback telegram will be transmitted only when the delay time after the bus voltage return has lapsed. If set to "No", a feedback telegram will be transmitted to the bus without delay immediately after the bus voltage return.

Central function

The Gateway provides the option to link selected individual or all groups with a 1-bit central communication object. The behaviour when activating a group via the central function is comparable to a central group address linked with all "Switching" objects.

The groups assigned to the central function are activated according to the received central object value. The polarity of the central telegram can be inverted via parameter.

The behaviour of the groups is identical to the 'normal' activation via the "Switching" objects (same priority – last switching command is executed – cf. fig. 12). Hence, all 'secondary' functions such as timing or additional functions are considered as well.

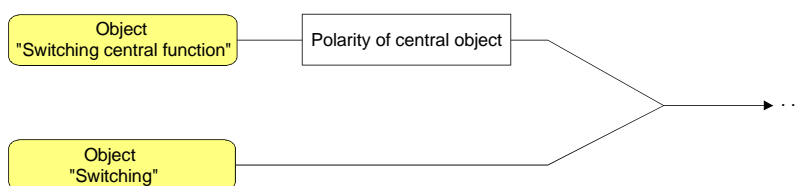

Fig.12: Functional diagram "Central switching"

Enabling the central function

- Enable the central function on the "General" parameter page by setting the "Central function?" parameter to "Yes".

When the function is activated, the "Switching central function" communication object becomes visible.

Assigning groups to the central function

Each DALI group can be assigned independently of the central function.

The central function must have been enabled on the "General" parameter page. Otherwise, the assignment will have no effect on a group.

- Set the "Assignment to central function ?" parameter in the "Groups – [x] group name – switching" parameter node (x = group number 1...32) to "Yes".

The corresponding group is now assigned to the central function. The assigned DALI devices can be switched on or off from a central control station.

- ⓘ The switching status set by the central function will be tracked in the feedback objects and also transmitted to the bus, if they are actively transmitting. The switching status set by a central function is not tracked in the "Switching" objects.
- ⓘ After a bus/ mains voltage return or after an ETS programming, the central function will always be inactive (object value "0").

4.2.4.4 Channel-oriented functional description

- ❶ Each group can be separately parameterized in the plug-in. During the programming with the ETS, the individual DALI devices will be programmed with the parameter data of the assigned groups. All devices assigned to a DALI group will be put into operation in the exact same way. If, however, DALI devices have been assigned to several groups these devices will receive the project design with the highest group number.

Defining the brightness range

The adjustable brightness range of a DALI group can be defined by setting a lower and an upper brightness value. The "Minimum brightness" and "Maximum brightness" parameters in the "groups - [x] group name" parameter node (X = group number 1...32) determine the brightness values that will not be exceeded or under-run during any of the activated operating states of the Gateway (cf. figure 13). This permits to individually adjust the brightness of the addressed lamps of the DALI devices – also to the perception of the human eye. The configured minimum brightness can only be under-run by switching it off.

In addition, it is possible to specify the brightness value for the devices of the group which is adjusted via the "Switching" or "Switching central function" objects every time it is switched on. The "Switch-on brightness" parameter in the "Groups - [x] group name" parameter node (x = group number 1...32) defines this "Switch-on brightness" parameter separately for each group. The adjustable value lies between the minimum and the maximum brightness values (cf. figure 13).

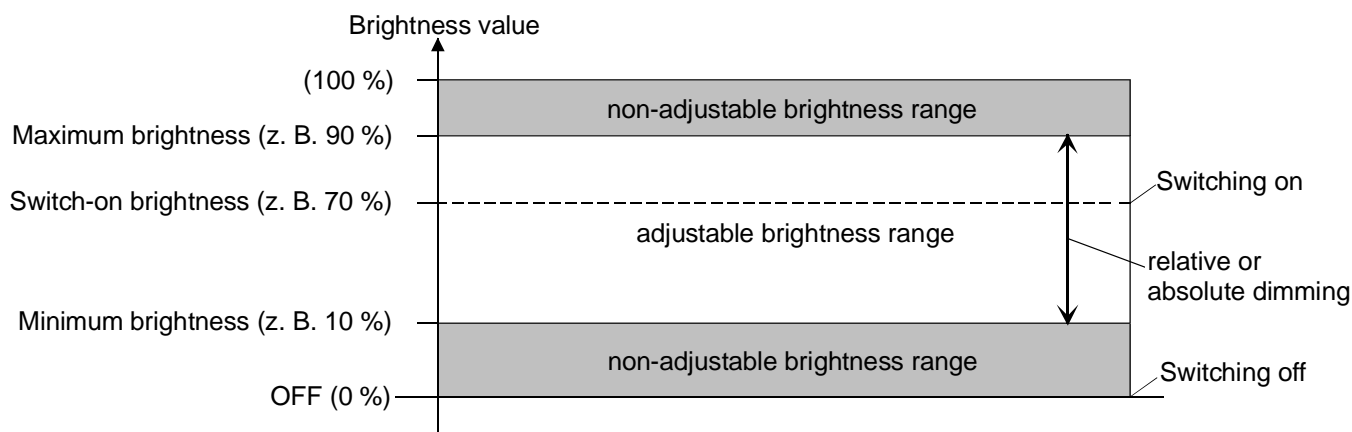

Figure 13: Example: Brightness range with the switch-on brightness of a DALI group

Setting the minimum brightness

The minimum brightness can be set separately for each DALI group.

- Set the "Minimum brightness" parameter in the "Groups- [x] group name" parameter node (x = group number 1...32) to the required brightness value.
The adjusted brightness will not be under-run in any of the activated operating states.

- ❗ The adjustable value cannot exceed the parameterized maximum brightness (minimum brightness < maximum brightness).
- ❗ While the minimum brightness is adjusted, the ETS plug-in will check all parameterized brightness values of the group (e.g. switch-on brightness, scene values etc.) to see whether the values have exceeded the minimum brightness. If this is the case, the plug-in will report a conflict of values and offers the following option...
 - the brightness values can be adjusted to the minimum brightness or
 - the setting of the minimum brightness will be reset to the original value.
- ❗ In case values are received via the brightness value object that fall short of the parameterized minimum brightness, the Gateway will set the minimum brightness as the new brightness value for the affected group.

Setting the maximum brightness

The maximum brightness can be set separately for each DALI group.

- Set the "Maximum brightness" parameter in the "Groups- [x] group name" parameter node (x = group number 1.3.32) to the required brightness value.
The adjusted brightness will not be exceeded in any of the activated operating states.

- ❗ The adjustable value cannot fall short of the parameterized minimum brightness (minimum brightness < maximum brightness).
- ❗ While the maximum brightness is adjusted the ETS plug-in will check all parameterized brightness values of the group (e.g. switch-on brightness, scene values etc.) to see whether the values have exceeded the maximum brightness. If this is the case, the plug-in will report a conflict of values and offers the following option...
 - the brightness values can be adjusted to the maximum brightness or
 - the setting of the maximum brightness will be reset to the original value.
- ❗ In case values are received via the brightness value object that exceed the parameterized maximum brightness, the Gateway will set the maximum brightness as the new brightness value for the affected group.

Setting the switch-on brightness

The switch-on brightness can be set separately for each DALI group.

- Set the "Switch-on brightness" parameter in the "Groups - [x] group name" parameter node (x = group number 1...32) to "Brightness value". Select the required brightness value in the selection field.

On reception of an ON telegram the selected brightness will be set to the devices of the DALI group via the "Switching" communication object. In addition, the polarity of the parameterized switch-on brightness will be set to "Activated" on reception of a central telegram.

- Set the "Switch-on brightness" parameter in the "Groups - [x] group name" parameter node (x = group number 1...32) to "Memory value (brightness prior to last shutoff)".

When switching on, the brightness value equals the one that was active and internally stored prior to the shutoff (via the "Switching" or "Switching central function"). This value is permanently stored so that the value is pre-defined to the maximum after bus or mains voltage return or after programming with the ETS.

- ❗ Setting "Brightness value": The adjustable value to be selected cannot be smaller than the parameterized minimum brightness and cannot be larger than the configured maximum brightness.
- ❗ A memory value is internally stored by a switch-off telegram even if the bus controlled switch-off is overridden, for example, by a disable or forced-control position function or by manual control. In this case, the internally tracked brightness value will be stored as the memory value.
- ❗ If the no Soft-ON function is activated, the brightness value will be activated when switching on. When a Soft-ON function is activated, the switch-on brightness will be adjusted according to the dimming speed for the Soft-ON function.

Response to bus voltage failure, bus or mains voltage return or ETS programming

The switching states or brightness values of the DALI groups following bus voltage failure, bus or mains voltage return or after ETS programming can be set separately.

Setting the behaviour after programming with the ETS

The "Behaviour after ETS programming" parameter is created separately for each group in the "Groups - [x] group name" parameter node (x = group number 1...32). This parameter can be used to parameterize the brightness behaviour independently of the behaviour after bus/ mains voltage return.

- Set the parameter to "No change".
After the ETS programming, the DALI devices of a group will show not reaction and keep the current brightness value or remain switched off.
 - Set the parameter to "Switch-off".
The group will be switched off after the programming with the ETS has been completed, .
 - Set the parameter to "Brightness value". Select the required brightness value in the selection field.
The group will be set to the brightness value specified in the selection field. The adjustable value must be within the limits of the parameterized maximum and minimum brightness.
- ❗ The parameterized behaviour will be executed after every application or parameter download by the ETS. A simple download of the physical address alone or partial programming of only the group addresses will cause this parameter to be disregarded and the "Response to bus voltage return" parameter to be executed.
- ❗ An ETS programming can only take place if the DALI Gateway is connected to the mains voltage.
- ❗ A switching status set after an ETS programming cycle will be tracked in the feedback objects.
- ❗ When set to "No change": the communication objects of the Gateway will be initialized with "0" after a programming operation. In this case, the switching status or brightness value feedback returned will correspond to the 'true' brightness status of the group only if the group has been activated at least once via the bus or manual control. Feedback objects that are set to actively transmit will transmit no telegram.
- ❗ An ETS programming operation will terminate the active manual control mode.
- ❗ After programming with the ETS, the disable functions as well as the forced-control positions are always deactivated.
- ❗ The DALI Gateway will initialize after the ETS programming and will configure the connected devices with the group parameters via the DALI line. This is the reason why the entire DALI system has to be connected and fully activated after programming with the ETS. If at this point an error occurs in the DALI line (e.g. short-circuit, cable break), the DALI configuration cannot take place. The error has to be eliminated and the programming with the ETS has to be repeated! During the configuration, "- -" will be shown on the front panel in the 7-segment display.

Setting the response to bus voltage failure

The "Response to bus voltage failure" parameter is created separately for each group in the "Groups - [x] group name" parameter node (x = group number 1...32).

- Set the parameter to "No change".
Following a bus voltage failure, the DALI devices of a group will not react and keep the current brightness value or remain switched off.
 - Set the parameter to "Switch-off".
In case of bus voltage failure the group will be switched off.
 - Set the parameter to "Brightness value". Select the required brightness value in the selection field.
The group will be set to the brightness value specified in the selection field. The adjustable value must be within the limits of the parameterized maximum and minimum brightness.
- ❗ The DALI devices assigned to the group will behave according to the parameterized response to bus voltage failure ("SystemFailureLevel") even in case of a voltage failure in the DALI line (e.g. short-circuit, cable break, mains voltage failure only at the DALI Gateway).
- ❗ The current states of the forced-control positions will also be stored in case of bus or mains voltage failure so they can be resumed, if needed, after the return of bus and mains voltage (depends on the parameterization of the forced-control position functions).
- ❗ A bus voltage failure will always cause the deletion of active disable or forced-control position functions rendering them inactive.

Setting the response to bus voltage return

The "Response to bus voltage return" parameter is created separately for each group in the "Groups - [x] group name" parameter node (x = group number 1...32). The parameter also defines the behaviour after mains voltage return.

- Set the parameter to "No change".
Following a bus/ mains voltage failure, the DALI devices of a group will show no response and keep the current brightness value or remain switched off.
- Set the parameter to "Switch-off".
The group will be switched off in case of bus/mains voltage failure.
- Set the parameter to "Brightness value as prior to bus voltage failure".
After bus/ mains voltage return, the brightness value that was internally stored last prior to the bus/ mains voltage failure is resumed.
- Set the parameter to "Brightness value". Select the required brightness value in the selection field.
The group will be set to the brightness value specified in the selection field. The adjustable value must be within the limits of the parameterized maximum and minimum brightness.

- Set the parameter to "Start Staircase timer function".

Independent of the "Switching" object, the Staircase timer function will be activated after bus voltage return. Make sure that the Staircase timer function has been enabled in the parameterization of the plug-in. In case the Staircase timer function has not been enabled, this setting will produce no reaction after the return of bus/ mains voltage.
- ❗ Setting: "Brightness value as prior to bus voltage failure" When programming the application or the parameter with the ETS, the internally stored switching state will be reset to "Off – 0".
- ❗ Forced-control position as an additional function: The communication object of the forced-control position function can be separately initialized after bus voltage return. This will influence the reaction of the group if the forced-control position in case of bus voltage return has been activated. The parameterized "Response to bus voltage return" will be executed only if no forced-control position is activated after a bus voltage return.
- ❗ Disable function as an additional function: Active disable functions will always be inactive after a bus or mains voltage failure.
- ❗ Any switching state set after a bus/ mains voltage return will be tracked in the feedback objects.
- ❗ When the mains voltage returns at the connected DALI devices (e.g. supply via another mains phase conductor) the devices will adjust to the brightness according to their "PowerOnLevel". This value will be programmed into the devices during the commissioning of the DALI Gateway and corresponds to the "Response to bus voltage return".

When set to "No change", "Switch off", "Brightness value as prior to bus voltage failure" and "Start Staircase timer function", the value for minimum brightness will be programmed as "PowerOnLevel" into the devices.
- ❗ When set to "No change": the communication objects of the Gateway will be initialized with "0" after bus/ mains voltage return. In this case, the returned switching status or brightness value feedback corresponds to the 'true' brightness status of the group only if the group has been activated at least once via the bus or manual control. No telegram will be transmitted if feedback objects are set to actively transmitting.
- ❗ As soon as bus voltage returns the active manual control will be terminated. Manual control is unavailable during a mains voltage failure.
- ❗ The DALI Gateway initializes after mains voltage return. During the initialization, "- -" will be displayed on the front panel in the 7-segment display.

Additional functions

Additional functions can be enabled for each DALI group.. A disable function or, alternatively, a forced-control position function can be configured to serve as an additional function. Only one of these functions can be enabled for an group.

These additional functions are enabled and parameterized in the "Group - [x] group name" parameter node (x = group number 1...32).

Setting the disable function as an additional function

The KNX/EIB control of the groups will be overridden and locked in case of an active disable. The override feature can, for example, also be used to implement a permanent lighting function.

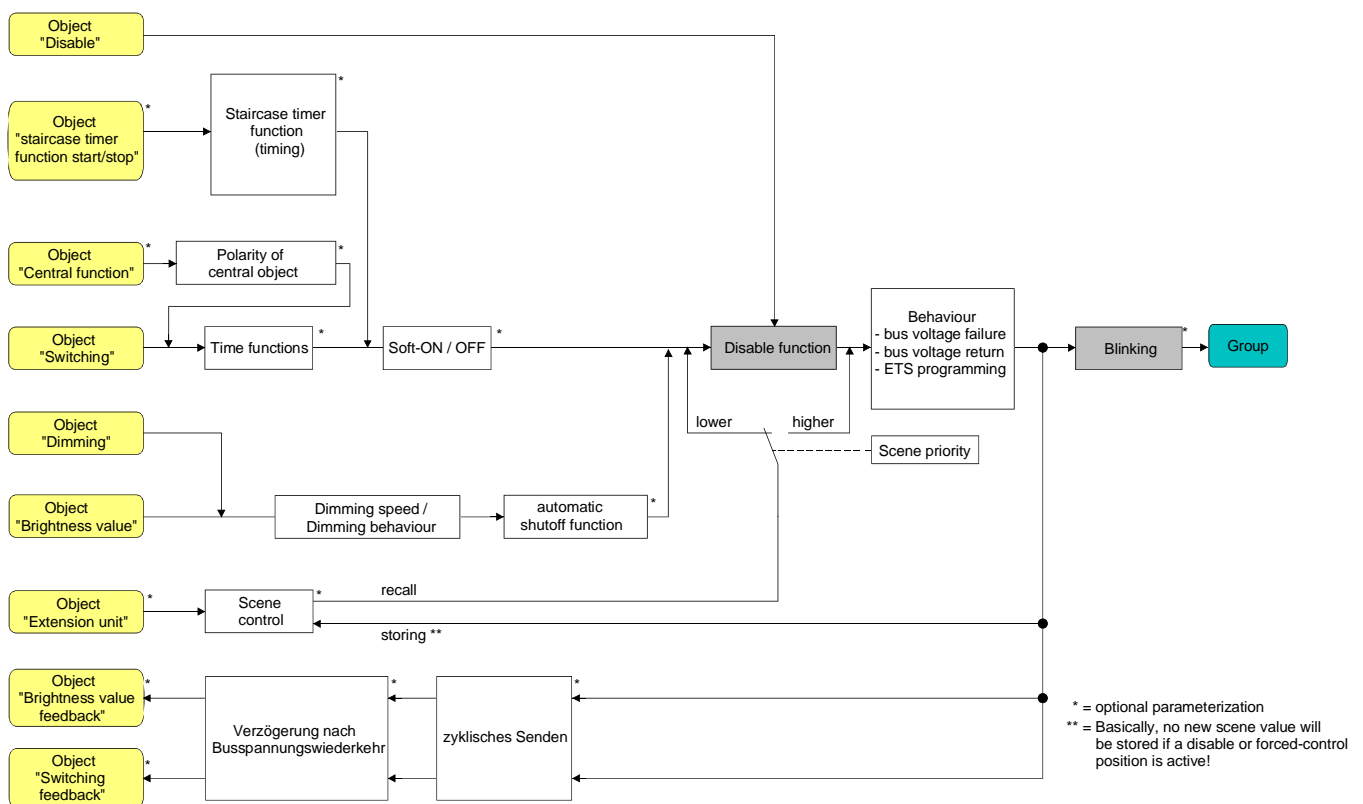

Fig. 14: Functional diagram of the disable function

- Set the "Type of additional function" parameter in the "Groups - [x] group name" parameter node (x = group number 1...32) to "Disable function".
The disable function has now been enabled. The "Disable" communication object and the parameters of the disable function become visible.
- Set the "Polarity of disable object" parameter in the "Groups - [x] group name" in the parameter node to the desired polarity.

- Set the "Response at the beginning of the disable function" parameter in the "Groups - [x] group name" parameter node to the required behaviour.

At the beginning of the disable, the parameterized behaviour will be executed and the bus control of the group will be locked. If the "No change" setting is selected, the devices of the disabled group will show no reaction and remain in the brightness state last set by the disable function.

If the "Blinking" setting is selected, the group will be switched on and off cyclically during the disable. The "Blinking rate" is generally parameterized for all groups in the "General" parameter node (x = group number 1...32). During the blinking, the logical switching state of the group will be reported as "Switched on – 1" and the brightness value as "Switch on brightness". A Soft-ON/OFF function will not be executed during the blinking.

If "Memory value" is selected, the brightness value will be set to the brightness value that was active and internally stored prior to the switch-off (via the "Switching" or "Switching central function"). This memory value is permanently stored so that the value is pre-defined to the maximum brightness after bus or mains voltage return or after programming with the ETS.
 - Set the "Response at the end of the disable function" parameter in the "Groups - [x] group name" parameter node to the required behaviour.

At the end of the disable, the parameterized behaviour will be executed and the bus mode re-enabled. If the "No change" setting is selected, the devices of the disabled group will show no reaction and remain in the state last set by the disable function.

If "Tracked brightness value" is selected, the state received or set prior to the executed disable function will be resumed with the applicable brightness value. If applicable, active time functions will also be considered.

When the "Blinking" setting is selected, the group is switched on and off cyclically after the disable. Generally, the "Blinking rate" is parameterized for all groups in the "General" parameter node (x = group number 1...32). During the blinking, the logical switching state of the group will be reported as "Switched on – 1" and the brightness value as "Switch on brightness". A Soft-ON/OFF function will not be executed during the blinking. The blinking state will remain active until another bus command is received or until the manual control will provide a different brightness value.

When "Memory value" is selected, the brightness value will be set to the brightness value that was active and internally stored prior to the switch-off (via the "Switching" or "Switching central function"). This memory value is permanently stored so that the value is pre-defined to the maximum brightness after bus or mains voltage return or after programming with the ETS.
- ❏ The disable function will always be deactivated after a bus or mains voltage failure or after programming the application with the ETS. In the inverted setting ("0 = enabled; 1 = disabled"), a "0" telegram update must first be sent after the initialization before the disabled state is activated.
 - ❏ Updates of the disable object from "Activated" to "Activated" or from "Deactivated" to "Deactivated" will have no reaction on the DALI devices. When updating from "Activated" to "Activated", feedback telegrams will be transmitted to the KNX/EIB according to the adjusted disable behaviour if feedback is enabled and actively transmitting.
 - ❏ A group that has been disabled via the KNX/EIB can still be operated manually. At the end of a manual control, the Gateway will re-execute the disable function for the affected groups if the disable is still activated at this point.
 - ❏ When "Tracked brightness value" is selected: The overridden functions of the DALI Gateway (switching, dimming, brightness value, scenes) will internally still be processed during the disable. Thus, newly received bus telegrams will be evaluated and time functions will be triggered. The tracked states will be set at the end of the disable. A scene recall will not be tracked.

Setting the forced-control position function as an additional function

As shown on the functional diagram (cf. Fig. 15), the forced-control position function can also be combined with other functions of a group. In case of an active forced-control position function, the upstream functions are overridden so that the affected group will be locked.

The forced-control position function features a separate 2-bit communication object. The first bit (bit 0) of the "Forced-control position" indicated whether the group will be switched on or off by forced control. In case of a switch-on by forced control, an ETS parameter determines the brightness value to be switched on. The second bit (bit 1) activates or deactivates the forced control (cf. Table 2).

The behaviour of a group at the end of the forced-control position can be parameterized. In addition, the forced object can be initialized upon the return of bus or mains voltage.

Bit 1	Bit 0	Function
0	X	forced-control position not active ⇒ Regular control
0	x	Forced-control position not active ⇒ Regular control
1	0	Forced-control position active: Switch off
1	1	Forced-control position active: Switching on to pre-defined brightness value

Table 2: Bit coding of the forced-control position

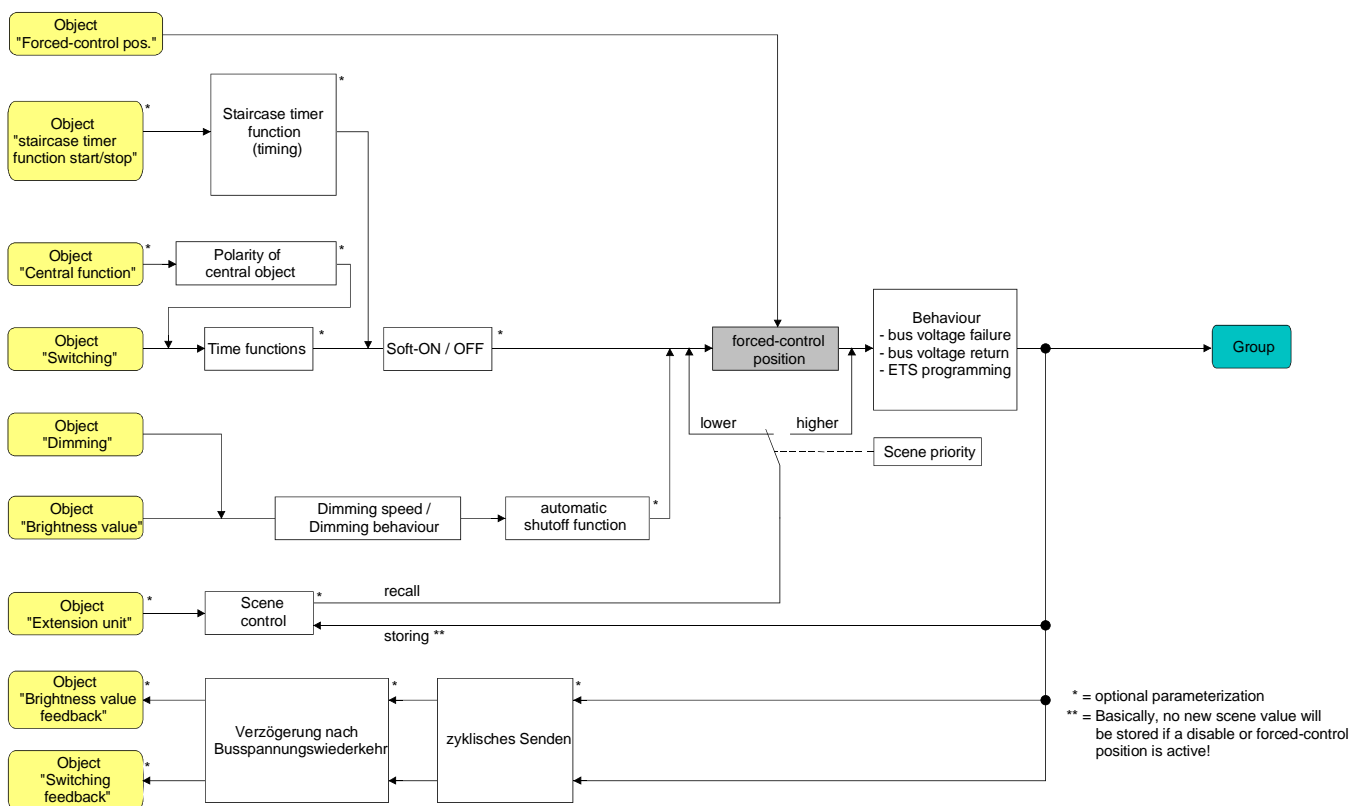

Fig.15: Functional diagram of the forced-control position function

- Set the "Type of additional function" parameter in the "Groups - [x] group name" parameter node (x = group number 1...32) to "Forced-control position function".
The forced-control position function is now enabled. The "Forced-control position " communication object and the parameters of the forced-control position function become visible.
 - Configure the "Brightness for forced-control position active, ON" parameter in the "Groups - [x] group name" parameter node to the response required if a forced control has been activated via the communication object.
In case of the "Brightness value" setting, the DALI devices of the group will set the brightness selected in the selection field when forced control has been activated. The selectable value cannot fall outside the limits of the parameterized maximum and minimum brightness.
When the "No change" setting is selected, the bus mode of the group will be locked. However, the devices will show no reaction and remain in the brightness state that was last set.
When the "Memory value" setting is selected, the brightness value will be set to the brightness value that was active and internally stored prior to the switch-off (via the "Switching" or "Switching central function"). This memory value is permanently stored so that the value is pre-defined to the maximum brightness after the return of bus or mains voltage or after programming with the ETS.
 - Set the "Response at the end of the forced-control position" parameter in the "Groups - [x] group name" parameter node to the required behaviour.
At the end of the forced-control position, the parameterized behaviour will be executed and the bus control of the group re-enabled. When the "No change" setting is selected, the devices will show no reaction and remain in the brightness state last set by the forced-control position.
When "Tracked brightness value" is selected: at the end of a forced-control position function, the brightness state received during or set before the function can be resumed. If applicable, active time functions will also be considered.
- ⓘ Updates of the forced-control position object from "Forced-control position active" to "Forced-control position active" while tracking the forced switching status or updates from "Forced-control position not active" to "Forced-control position not active" will cause no reaction. When updating from "Forced-control position active" to "Forced-control position active", feedback telegrams will be transmitted to the KNX/EIB according to the adjusted forced behaviour if feedback is enabled and actively transmitting.
- ⓘ A group that has been disabled via the KNX/EIB can still be operated manually. At the end of a manual control, the Gateway will re-execute the forced response for the affected groups if the forced-control position is still activated at this point.
- ⓘ At the end of the forced-control position with "Tracked brightness value" setting selected": The overridden functions of the DALI Gateway (switching, dimming, brightness value) will internally still be processed during a forced-control position. Thus, newly received bus telegrams will be evaluated and time functions will be triggered. The tracked states will be set at the end of the forced control. A scene recall will not be tracked.
- ⓘ The current state of the object of the forced-control position will be stored in case of bus or mains voltage failure.

- Set the "Response to bus voltage return" parameter in the "Groups - [x] group name" parameter node to the required behaviour.

After bus or mains voltage return, the parameterized state will be adopted in the "Forced-control position" communication object. In case of an active forced-control position, the group will be addressed and locked by forced control immediately after the return of bus/ mains voltage to the corresponding state until the forced-position condition is cancelled via the bus. In this case the "Response to bus voltage return" parameter in the "Groups - [x] group name" parameter node will not be evaluated for the affected group.

When set to "Status as prior to bus voltage failure" the status of the forced-control position that was last set and stored internally prior to bus or mains voltage failure will be resumed after the return of bus or mains voltage. An ETS programming operation will delete the stored state (reaction same as "No forced-control position active").

If the tracked "No forced-control position" state is active, the "Response to bus voltage return" parameter, which is independent of forced control, will be executed after the bus voltage returns. In case of an activated forced-control position the DALI devices of the group will be switched on to the brightness value provided by the "Brightness for forced-control position active, ON" parameter.

- ❗ After programming the application or the parameters with the ETS, the forced control position function will always be deactivated (object value "0").

Feedback for switching status and brightness value:

The DALI Gateway can track the current switching status and brightness value of a DALI group via separate feedback objects. It can also transmit them to the bus if the bus voltage has been switched on.

The following feedback objects can be independently enabled for each DALI group...

- Switching status feedback (1-bit),
- Brightness value feedback (1-byte).

The Gateway will compute the object value of the feedback objects every time switching or dimming is taking place. Even if a group is controlled via manual control or the scene function, the Gateway will track the switching status or the brightness value and update the feedback objects.

The switching status feedback object will be updated during the following events...

- immediately after switching on a DALI group (if applicable, only after a On-delay has lapsed and at the beginning of a SOFT-ON dimming operation / applies also to a Staircase timer function),
- immediately after switching off a DALI group (if applicable, only after a Off-delay has lapsed and at the beginning of a SOFT-Off dimming operation / applies also to a Staircase timer function),
- immediately after switch-off by the automatic Shutoff function,
- at the beginning of a dimming operation when increasing brightness (relative increase of brightness or brightness value = 1...100 %) of a DALI group,
- at the end of a dimming operation when increasing brightness of a group (brightness value = 0 %),
- only if the switching status changes during "Normal operation" (thus not during dimming without changes to the switching status, e.g. from 10 % to 50 % brightness),
- during updates of the switching status from "OFF" to "OFF" if the DALI group has already been shut off,
- always at the beginning or the end of a disable or forced-control position function (even if it does not cause the switching status to change),
- always at the return of bus/ mains voltage or at the end of a programming operation with the ETS (if applicable, even if time-delayed).

The brightness value feedback object will be updated during the following events...

- at the end of a relative (4-bit) or an absolute (1-byte) dimming operation.
- immediately after switching on a DALI group if switch-on brightness has been set (if applicable, only after an On-delay has lapsed and at the beginning of a SOFT-ON dimming operation / applies also to a Staircase timer function),
- immediately after switching off a DALI group (if applicable, only after a Off-delay has lapsed and at the beginning of a SOFT-Off dimming operation / applies also to a Staircase timer function),
- immediately after switch-off by the automatic Shutoff function,
- only if the brightness value changes during the 'normal operation' (in case a preset brightness value has been exceeded or under-run the maximum or minimum brightness by external relative or absolute dimming, the Gateway will update a brightness value feedback according to the maximum and minimum brightness),
- when updating the switching status from "ON" to "ON" or from "OFF" to "OFF",
- during each scene recall (even if it does not cause the brightness value to change),
- always at the beginning or the end of a disable or forced-control position function (even if it does not cause the brightness value to change),
- always after the return of bus/ mains voltage or at the end of a programming operation with the ETS (if applicable, even if time-delayed).

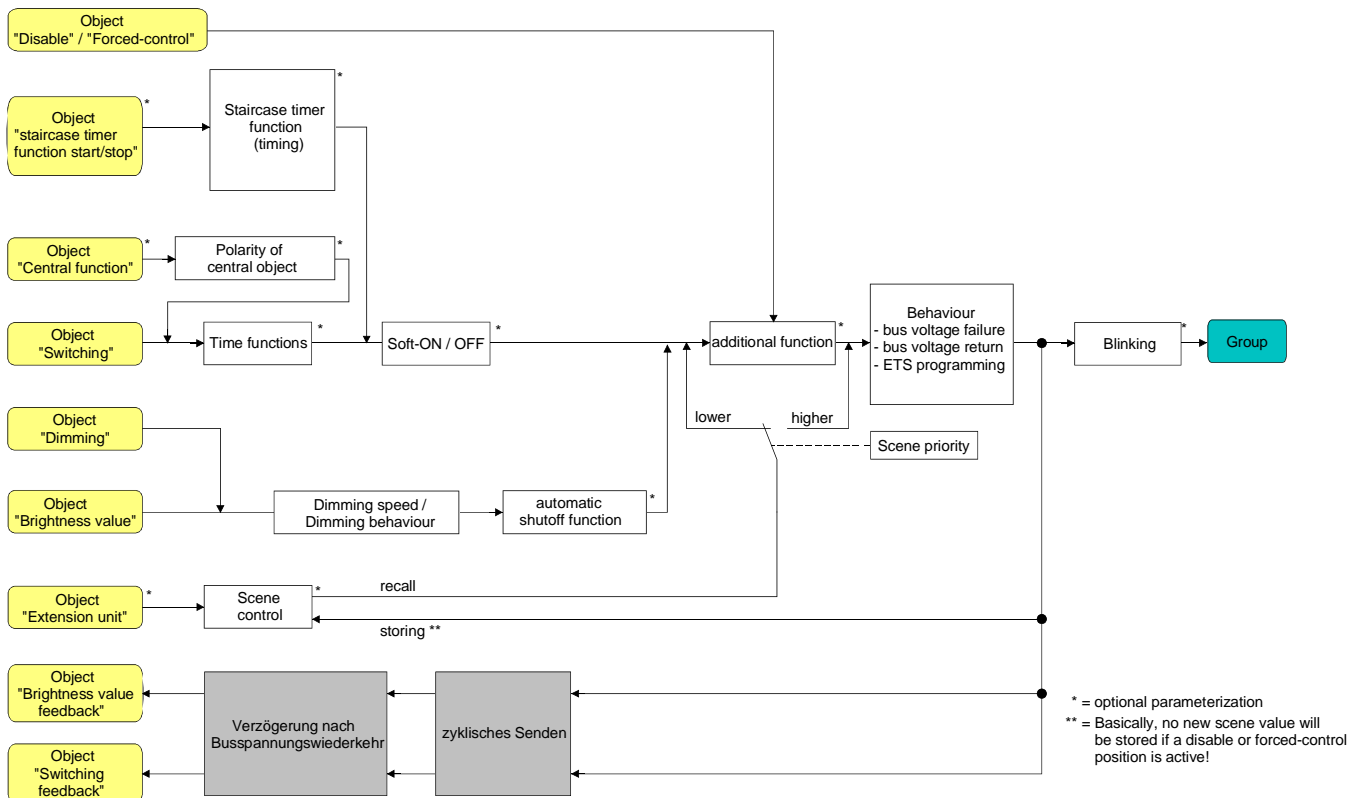

Fig. 16: Functional feedback diagram

- i Disable function as an additional function: A 'blinking' DALI group will always be reported back as "Switched on" and with the switch-on brightness. Switching status feedback will be transmitted for disabled groups as well, if the outputs, for example, have been manually adjusted.
- i The characteristic dimming curve is logarithmic – as it is common in a DALI system. Thus, the brightness behaviour of the DALI lights during the dimming will adjust to the sense of brightness of the human eye. The DALI Gateway automatically converts the linear dimming progress in the KNX/EIB into a logarithmic one (0 / 0 % ... 255 / 100 %). A value feedback to the KNX/EIB will also be converted. This means that the internal calculation process may result in slight differences between the brightness value that is specified and the brightness value that is returned (e.g. specification = 50% -> returned = 49 %)!

Activating the switching status feedback function

The switching status feedback can be used as an active message object or as a passive status object. As an active message object, the switching status feedback information will also be directly transmitted to the bus. As a passive status object, there will be no telegram transmission after an update. In this case, the object value must be read-out. The ETS automatically sets the object communication flags required for proper functioning.

The "Switching status feedback ?" parameter is separately created for each DALI group in the "Groups - [x] group name - switching" parameter node.

- Set parameter to "Yes, feedback object is active message object"

The "Switching status feedback" object will be enabled. The switching status will be transmitted once the status has been updated. After a bus/ mains voltage return or after programming with the ETS, a feedback telegram will be automatically transmitted.

- Set parameter to "Yes, feedback object is passive status object"

The "Switching status feedback" object will be enabled. The switching status will be transmitted only if the feedback object is read by the bus. After bus voltage return or after programming with the ETS, there will be no automatic transmission of the feedback.

Setting switching status feedback on return of bus/ mains voltage or after programming with the ETS

If used as an active message object, the switching status feedback information is transmitted to the bus after bus voltage return or after programming with the ETS. In these cases, the feedback telegram can be time-delayed with the delay being preset globally for all DALI groups together (cf. "Delay after bus/ mains voltage return").

- Set the "Time delay for feedback telegram after bus voltage return" parameter in the "Groups - [x] groupname - switching" to "Yes".

The switching status telegram transmission will be delayed after bus/ mains voltage return or after programming with the ETS. No feedback telegram is transmitted during a running delay time, even if the switching state changes during this delay.

- Set the "Time delay for feedback telegram after bus voltage return" parameter in the "Groups - [x] groupname - switching" to "No".

The feedback switching status telegram will be transmitted immediately after bus/ mains voltage return or after programming with the ETS.

Setting the cyclical transmission function for the switching status feedback telegram

In addition to being transmitted in case of an update, the switching status feedback telegram can also be transmitted cyclically via the active message object.

- Set the "Cyclical transmission of feedback telegram?" parameter in the "Groups - [x] group name - switching" to „Yes“.
Cyclical transmission is now activated.
 - Set the "Cyclical transmission of feedback telegram?" parameter in the "Groups - [x] group name - switching" to „No“.
Cyclical transmission is now deactivated which means that a feedback telegram is transmitted to the bus only if one of the switching states has been updated.
- ❗ The cycle time is defined centrally for all DALI groups in the "Groups" parameter node.
- ❗ During an active delay time, no feedback telegram will be transmitted even if a switching state has changed.

Activating brightness value feedback

The brightness value feedback can be used as an active message object or as a passive status object. In case of an active message object the brightness value feedback telegram will also be directly transmitted to the bus after each update. As a passive status object, there will be no telegram transmission after an update. In this case, the object value must be read-out. The ETS automatically sets the object communication flags required for proper functioning.

The "Brightness value feedback ?" parameter is separately created for each DALI group in the "Groups - [x] group name - dimming" parameter node.

- Set parameter to "Yes, feedback object is now active message object"
The "Brightness value feedback" object will be enabled. The brightness value will be transmitted once it has been updated. After a bus/ mains voltage return or after programming with the ETS, a feedback telegram will be automatically transmitted.
- Set parameter to "Yes, feedback object is passive status object"
The "Brightness value feedback" object will be enabled. The brightness value will be transmitted only if the feedback object is read-out by the bus. After bus voltage return or after programming with the ETS, there will be no automatic transmission of the feedback.

Setting the brightness value feedback on return of bus/ mains voltage or after programming with the ETS

If used as an active message object, the brightness feedback information is transmitted to the bus after bus voltage return or after programming with the ETS. In these cases, the feedback telegram can be time-delayed with the delay time being preset globally for all DALI groups together (cf. "Delay after bus/ mains voltage return").

- Set the "Time delay for feedback telegram after bus voltage return" parameter in the "Groups - [x] groupname - dimming" to "Yes".
The brightness feedback transmission will be delayed after bus/ mains voltage return or after programming with the ETS. No feedback telegram is transmitted during a running delay time, even if the brightness has changed during this delay.
- Set the "Time delay for feedback telegram after bus voltage return" parameter in the "Groups - [x] groupname - dimming" parameter node to "No".
The brightness feedback transmission will be transmitted immediately after bus/ mains voltage return or after programming with the ETS.

Setting the cyclical transmission function for the brightness feedback telegram

In addition to being transmitted in case of an update, the brightness value feedback telegram can also be transmitted cyclically via the active message object.

- Set the "Cyclical transmission of feedback telegram?" parameter in the "Groups - [x] group name - dimming" parameter node to „Yes“.
Cyclical transmission is now activated.
- Set the "Cyclical transmission of feedback telegram?" parameter in the "Groups - [x] group name - dimming" parameter node to „No“.
Cyclical transmission is now deactivated meaning that a feedback telegram is transmitted to the bus only if a brightness value has been updated.

- i The cycle time is defined centrally for all DALI groups in the "Groups" parameter node.
- i During an active delay time, no feedback telegram will be transmitted even if a brightness value has changed.

Dimming response and dimming speeds

The brightness for the devices of a DALI group can be changed by a dimming operation. The available range of brightness is defined by the maximum and minimum brightness provided by the ETS (cf. Figure 17).

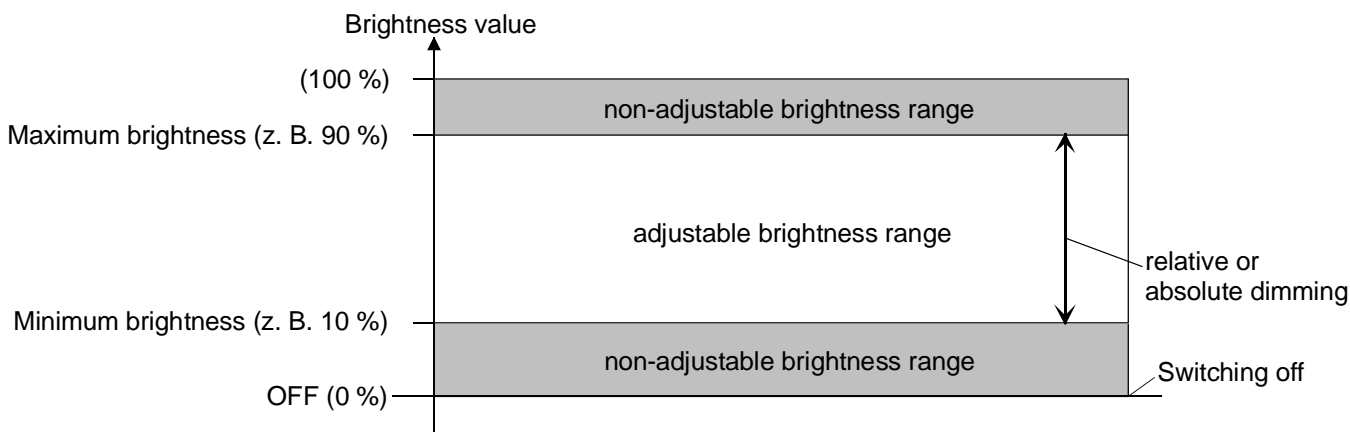

Figure 17: Adjustable range of brightness available for dimming (example)

Dimming a DALI group can take place via...

- relative dimming:

A relative dimming can be triggered either via the 4-bit “Dimming” communication object that is separately available for each group or manually via a long key-press. The data format of the “Dimming” object corresponds – as is usually the case with dimming actuators – to the KNX standard according to DPT “3.007” so that the dimming telegram provides the direction (increase/decrease) and the relative dimming increments. Dimming can also be stopped. Relative dimming executed manually and locally at the DALI Gateway takes place for as long as the corresponding key is pressed. Dimming stops once the key is released or the maximum or minimum brightness has been reached.

The dimming speed for relative dimming can be parameterized separately for each group in the plug-in of the DALI Gateway.

- absolute dimming:

absolute dimming will be triggered by providing a brightness value. This value can be provided by the KNX/EIB via the 1-byte “Brightness value” communication object separately available in each group. In addition, it is also possible to set brightness values via a disable or forced-control position function or via the scene function. An absolute dimming can be activated by providing brightness values even in case of bus voltage failure or bus/ mains voltage return or after programming with the ETS.

When providing a brightness value via the object or via a scene recall it is possible to program with the ETS plug-in whether the value will be instantly jumped to or dimmed to over a dimming time. In the case of all other dimming functions, the brightness values are always instantly jumped to.

- Even if brightness values are instantly jumped to the dimming will take a short time with the DALI devices of a group. This applies also to the switching without the Soft-ON or – OFF function. This dimming procedure depends on the system. The brightness value instantly jumped to will be dimmed up within 0.7 s (short fading). This time cannot be changed.

The setting of a dimming time for the relative dimming or for the absolute dimming (with the brightness values dimmed to) of the DALI Gateway is system-related for the entire brightness range of the system (cf. figure 18). The time entered in the ETS defines the maximum duration for the logarithmic dimming common in the DALI system over the entire brightness range from 0 % to 100 %. The dimming increments are directly derived from the parameterized times.

Examples:

Parameterized time for relative dimming = 10 s / adjusted brightness value = 50 % → relative dimming from 50 % to 100 % → the dimming procedure requires 5 s.

Parameterized time for absolute dimming = 20 s / adjusted brightness value = 25 % → absolute dimming from 25 % to 100 % → the dimming procedure requires 15 s.

- When parameterizing the dimming times the time for the dimming will be always defined across the entire brightness range (0...100 %). A minimum or maximum brightness parameterized in the ETS does not limit the dimming times but will solely determine the dimmable range.

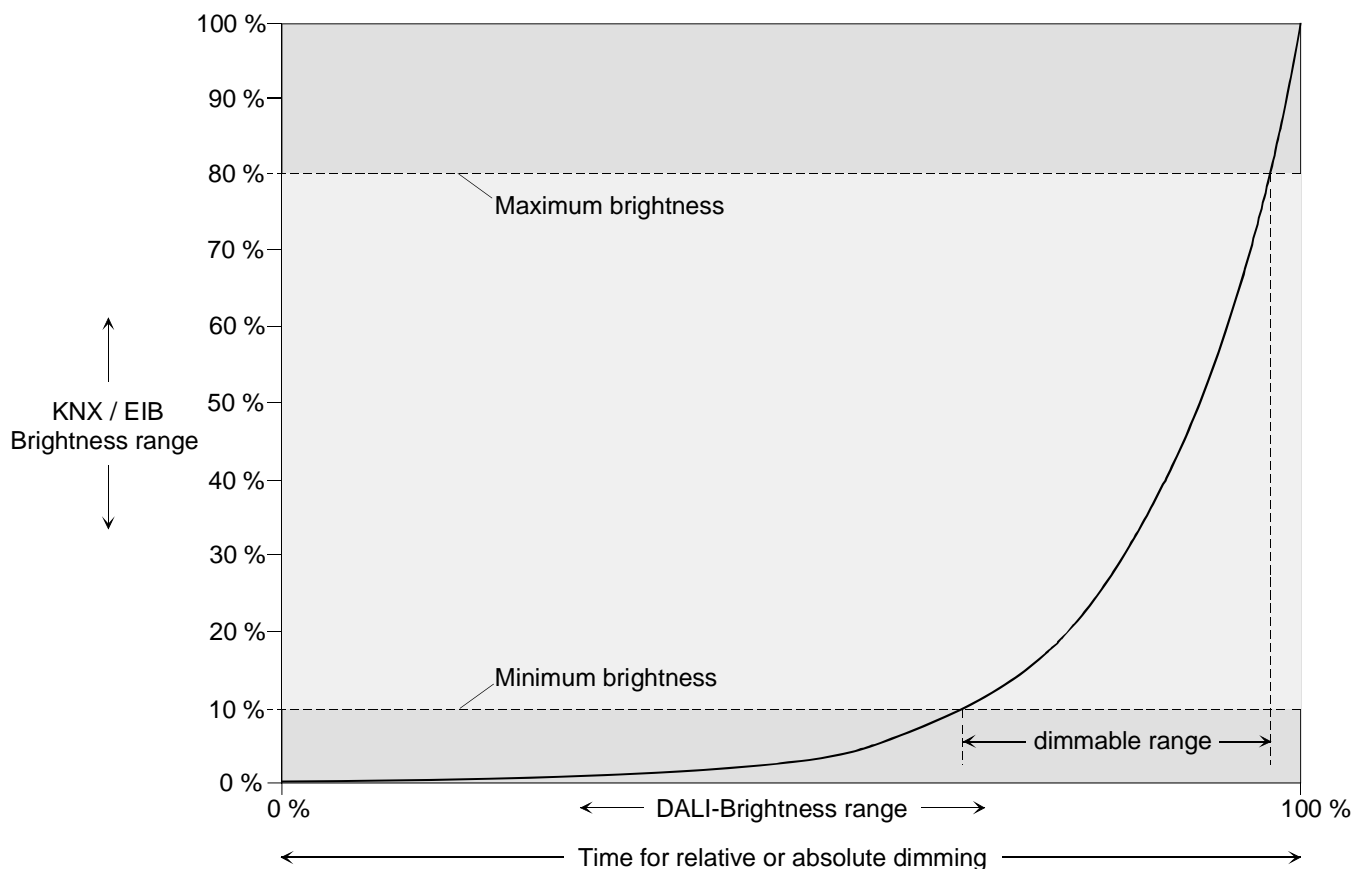

Figure 18: characteristic dimming curve for relative or absolute dimming for example with minimum and maximum brightness

The characteristic dimming curve shown in figure 18 is logarithmic – as it is common in a DALI system. Thus, the brightness behaviour of the DALI lights during the dimming will adjust to the sense of brightness of the human eye. The DALI Gateway automatically converts the linear dimming progress in the KNX/EIB into a logarithmic one (0 / 0 % ... 255 / 100 %). A value feedback to the KNX/EIB will also be converted. This means that the internal calculation process may result in slight differences between the brightness value that is specified and the brightness value that is returned (e.g. specification = 50% -> returned = 49 %)!

Setting the dimming time for relative dimming

The dimming time for the relative dimming can be separately set for each group in the plug-in of the DALI Gateway.

- Set the “Time for relative dimming (0...100 %)” parameter in the "Groups - [x] group name - dimming" parameter node to the desired dimming time.

Setting the dimming response for absolute dimming

The dimming response for the absolute dimming can be separately set for each group in the plug-in of the DALI Gateway via the “Brightness value” object.

- Set the “Dimming response to a brightness value” parameter in the "Groups - [x] group name - dimming" to „Dim“.

A new brightness value received will be set for the absolute dimming according to the computed dimming increments.

- Set the “Dimming response to a brightness value” parameter in the "Groups - [x] group name - dimming" to „Jump to“.

As soon as a new brightness value is received it will be instantly jumped to.

i In addition, it is also possible to set brightness values via a disable or forced-control position function. An absolute dimming can be activated by providing brightness values even in case of bus voltage failure or bus/ mains voltage return or after programming with the ETS. In case of these absolute dimming functions the brightness values will always be instantly jumped to. In case of a scene recall the dimming response can be configured separately (cf. 4.2.4.5 “Scene function”)

Setting the dimming time for absolute dimming

The dimming time for the absolute dimming can be separately set for each group in the plug-in of the DALI Gateway via the “Brightness value” object.

The dimming response must be parameterized to “Dim”.

- Set the “Time for absolute dimming (0...100 %)” parameter in the "Groups - [x] group name - dimming" parameter node to the desired dimming time.

Automatic shutoff

The shutoff function permits the automatic shutoff of a DALI group after the light intensity has been dimmed to a brightness value or jumped to and after this new brightness value falls below a shutoff brightness adjusted in the ETS. There is the option available to configure a delay until the shutoff (cf. figure 19).

The Shutoff function will be activated once a constant brightness value has been reached. Thus only after a completed dimming operation. A new dimming operation that also ends below the shutoff brightness will restart a configured delay, if applicable. The Shutoff function will be halted if the shutoff brightness has been exceeded by a dimming operation.

By applying the automatic shutoff function it is possible, for example, to not only set the lighting to a minimum brightness via relative dimming but also to shut it off. Another application, for example, is the time controlled 'Good night shutoff' for the dimmed lighting of a children's room.

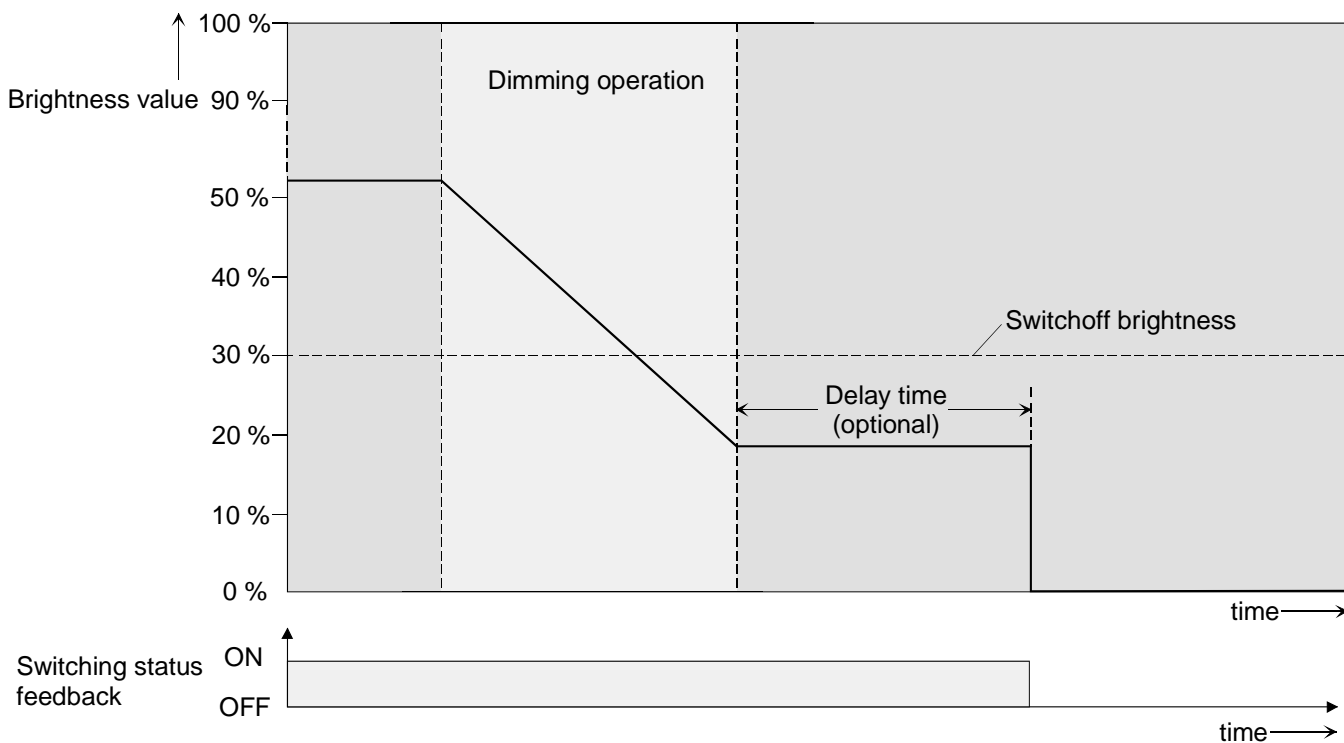

Figure 19: Dimming and switching response of the automatic shutoff function

- ❶ Basically, the shutoff takes place without the Soft-OFF function - instantly.
- ❶ The shutoff brightness can be adjusted within the dimmable brightness range between the parameterized maximum and minimum brightness. There will be no automatic shutoff if the shutoff brightness = minimum brightness since the value may not remain under the shutoff brightness. The shutoff function will be constantly active if the shutoff brightness has been configured to maximum brightness and if the maximum brightness can be under-run at any time.
- ❶ The feedback objects for the switching status and the brightness value will be updated via the automatic shutoff function after the shutoff.

The shutoff function can also be combined with other functions of the DALI Gateway. In this case make sure that the disable function, the forced-control position function or the scene function will override the shutoff function (cf. figure 20). The shutoff automatic can only be activated via a dimming operation that was initiated via the 4-bit ("Dimming") or 1-byte ("Brightness value") communication objects. If the shutoff function is overridden, the DALI Gateway will terminate the processing of the delay time and the evaluation of the shutoff brightness.

Switching-on (switch-on brightness) via the "Switching" communication object will not activate the shutoff function.

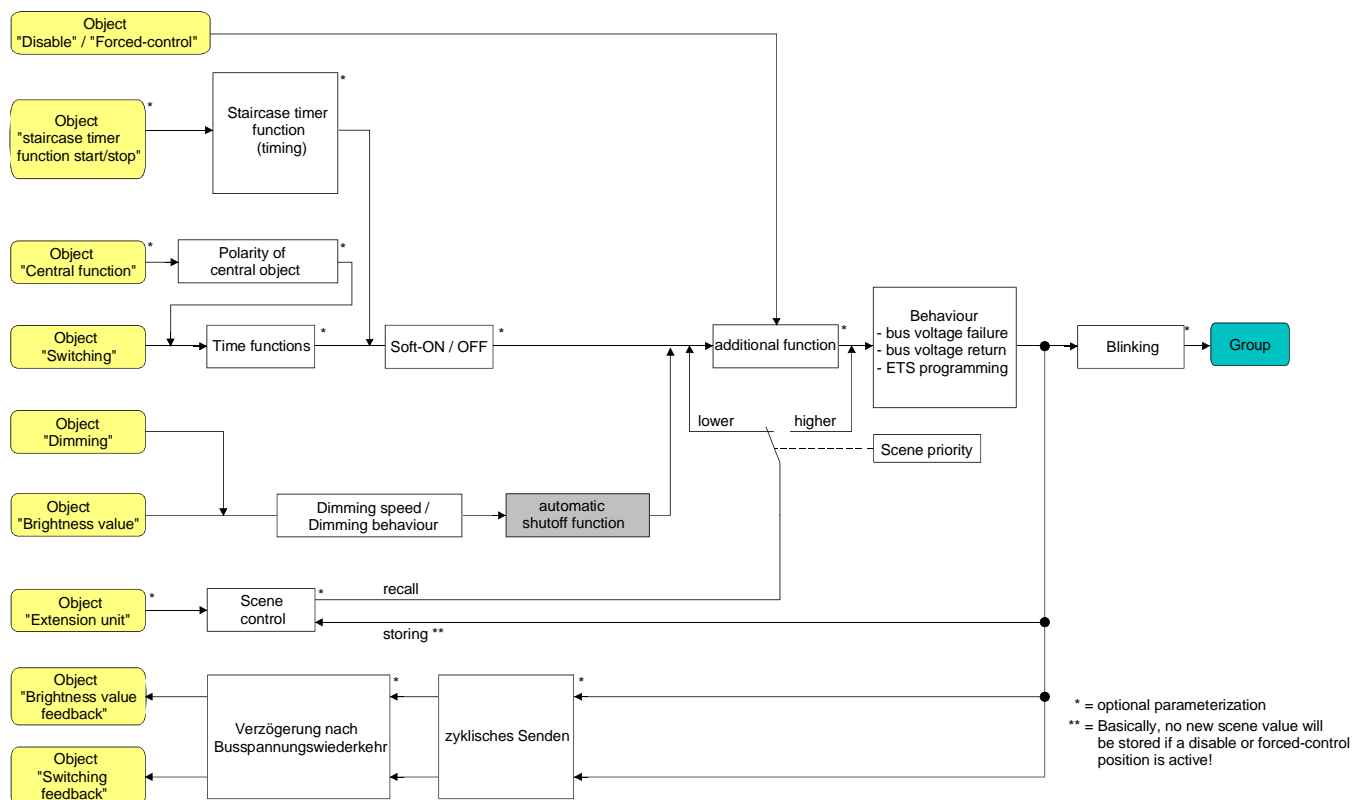

Fig. 20: Functional diagram of the automatic shutoff function

Enabling the automatic shutoff function

The automatic shutoff function can be set separately for each group in the plug-in of the DALI Gateway.

- Set the "Automatic shutoff when falling below a specified brightness value ?" parameter in the "Groups - [x] group name - dimming" to "Yes".

The automatic shutoff function is now enabled. Other parameters will become visible.

Setting the shutoff brightness

The shutoff function requires the definition of the shutoff brightness. The shutoff brightness is set separately for each DALI group.

The shutoff function must be enabled.

- Set the "Shutoff when brightness value is smaller" parameter in the "Groups - [x] group name - dimming" parameter node to the required brightness value.

Once a dimming operation causes a value to fall below the parameterized shutoff brightness and once the brightness has been set to constant, the DALI group will shut off or will start the delay until the shutoff. The selectable parameter must be within the limits of the maximum and minimum brightness.

Setting the delay of the shutoff function

A time delay can be activated before the shutoff function will automatically shut off when falling below the shutoff brightness at the end of a dimming operation. There is the option available to enable the time delay separately for each DALI group.

The shutoff function must be enabled.

- Configure the "Delay until shutoff ?" parameter in the "Groups - [x] group name - dimming" to "Yes".

Once a dimming operation causes a value to fall below the parameterized shutoff brightness and once the brightness has been set to constant, the DALI Gateway will trigger the delay time. The DALI group will completely shut off once the delay time has lapsed. The delay time can be retriggered by other dimming operations.

Time delays

Up to two time functions can be independently set for each DALI group. The time functions act solely on the "Switching" or "Switching central function" communication objects (if a central has been activated for the affected output) and will delay the received object value as a function of telegram polarity (cf. fig. 21).

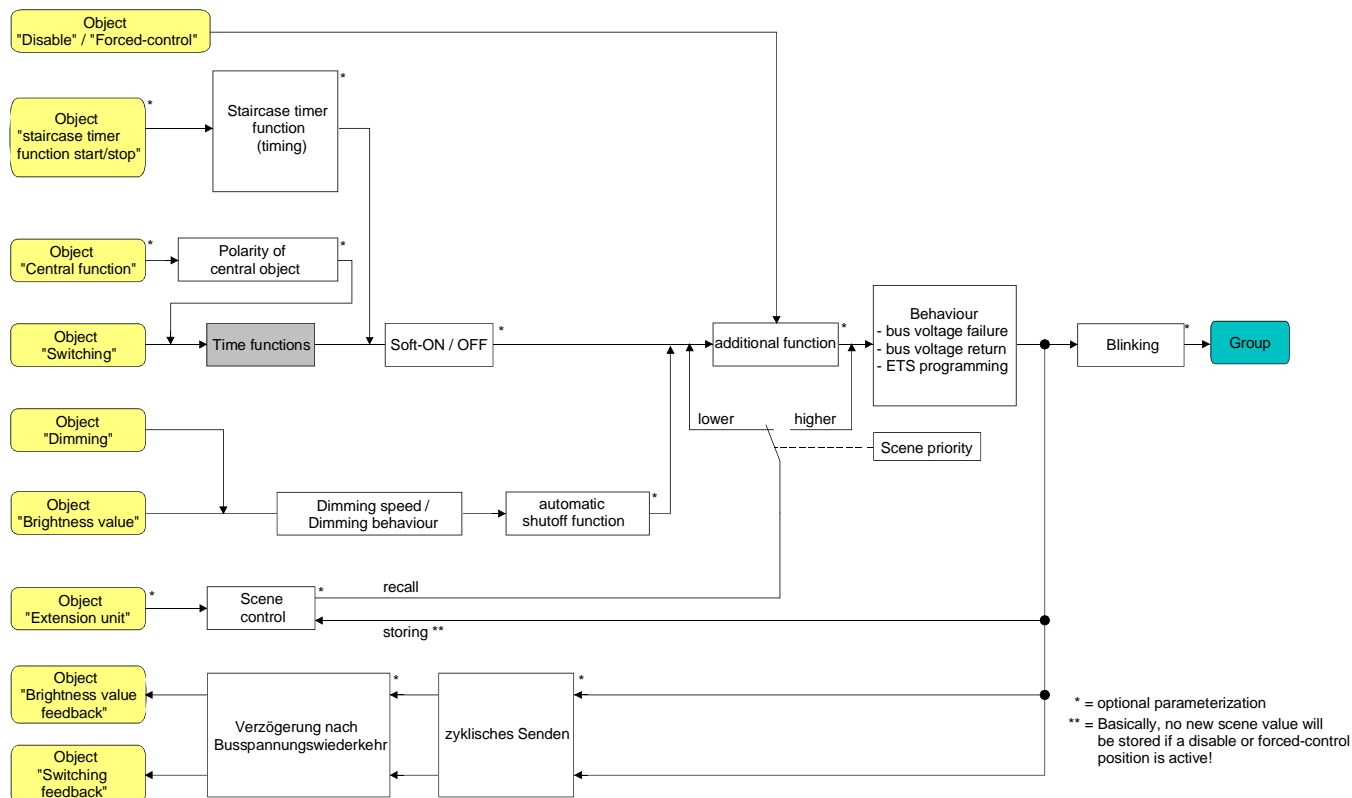

Fig.21: Functional diagram of the time delays

Activating an ON-delay

The On-delay can be parameterized separately for each group in the plug-in of the DALI Gateway.

- Set the "Selection of time delay" parameter in the "Groups - [x] group name – Switch-on/switch-off behaviour" parameter node to "ON-delay" or to "ON-delay and OFF-delay". Parameterize the desired On-delay time.

The ON-delay is now enabled. The parameterized time will start after receiving an ON telegram via the "Switching" object. A subsequent ON-telegram will retrigger the time only if the "ON-delay retriggerable?" parameter has been set to "Yes". An OFF-telegram received during the ON-delay will terminate the delay and set the switching status to "OFF".

Activating an OFF-delay

The Off-delay can be activated separately for each group in the plug-in of the DALI Gateway.

- Set the "Selection of time delay" parameter in the "Groups - [x] group name – Switch-on/switch-off behaviour" parameter node to "OFF-delay" or to "ON-delay and OFF-delay". Parameterize the desired Off-delay time.

The OFF-delay is now enabled. The parameterized time will start after receiving an OFF telegram via the "Switching" object. A subsequent OFF-telegram will retrigger the time only if the "OFF-delay retriggerable ?" parameter has been set to "Yes". An OFF-telegram received during the OFF-delay will terminate the delay and set the switching status to "OFF".

- ❗ Feedback: if a time delay has been preset and if the switching state is changed via the "Switching" object, the delay time must have elapsed before feedback telegrams will be transmitted. Updates of the object from "ON" to "ON" or from "OFF" to "OFF" by retriggering during a running delay time has no effect on the switching status feedback.
- ❗ At the end of a disable or forced-control position function, the brightness state received during or set prior to the function can be resumed. Residual times of time functions are resumed, if they have not completely elapsed at the time that the disable or forced-control position functions are disabled.
- ❗ The time delays have no influence on the Staircase timer functions, if these are enabled.
- ❗ A time delay in progress will be completely terminated by a reset of the actuator (bus/mains voltage failure or ETS programming).

Soft-ON/OFF function

The Soft functions permit the slowed-down switching on or off of a DALI group if a switching command is received via the "Switching" or "Switching central function" communication objects.

If a Soft-ON function is activated, dimming will be executed until the parameterized switch-on brightness has been reached. This will also be the case if the DALI group has been switched on to a brightness value that is smaller than the switch-on brightness value. If a Soft-OFF function is activated dimming will take place after receiving an OFF telegram until 0 % brightness is reached (cf. figure 22).

The dimming speeds can be parameterized separately for the Soft-ON as well as the Soft-OFF function in the ETS plug-in. As is the case with the relative or absolute dimming, the dimming time will be provided for the entire brightness range and thus for a brightness change of 0 % to 100 %. The DALI Gateway computes the dimming speed for a dimming increment of the Soft functions from the provided dimming time.

The Soft-ON or the Soft-OFF functions cannot be retriggered due to the reception of other switching telegrams while tracking the switching status. The Soft-functions can be activated and configured separately in the ETS plug-in.

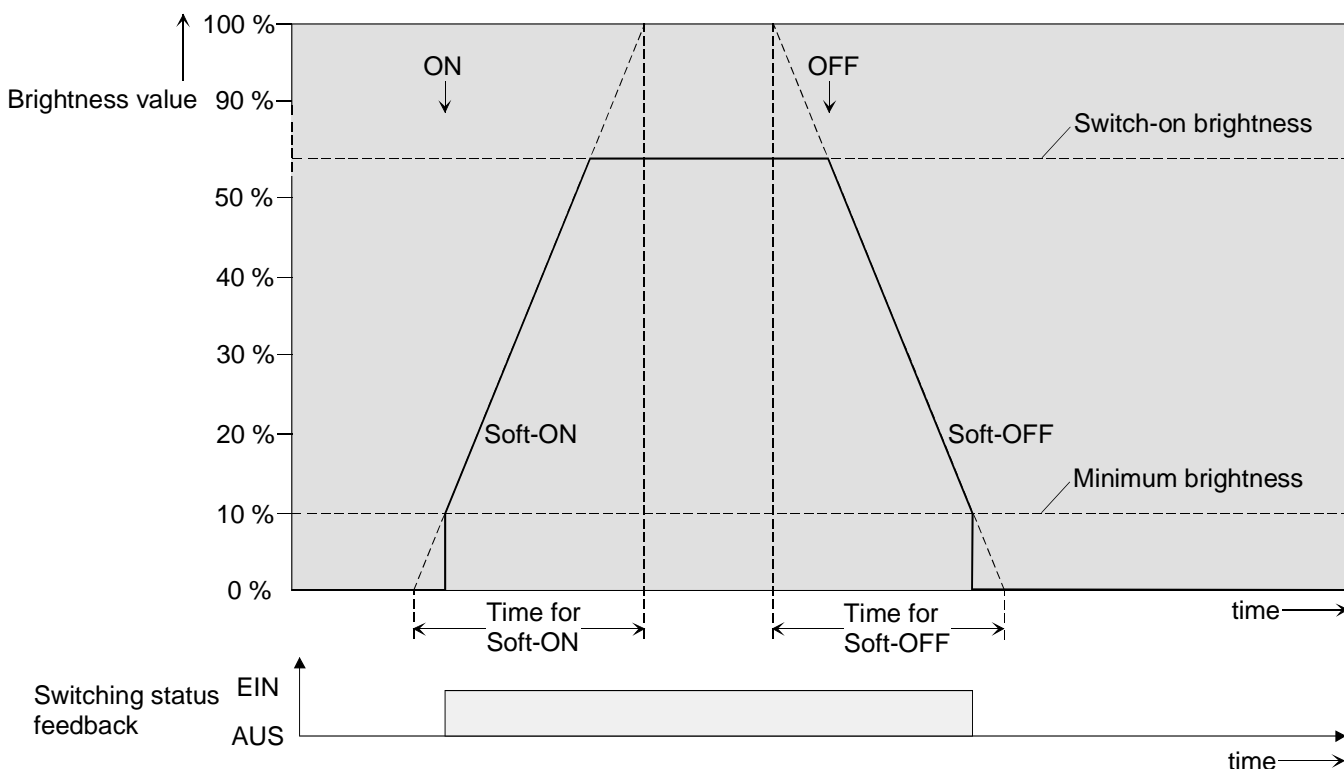

Figure 22: Dimming response of the Soft-ON/OFF functions
for example: minimum brightness > 0%

- ❗ The dimming of a Soft-ON function starts with the minimum brightness configured in the ETS plug-in. If a DALI group is switched off (brightness value = 0 %) and then switched on, the group will jump to the parameterized minimum brightness and will start the Soft-ON dimming with the switch-on brightness (cf. figure 22).

Figure 23 shows the functional diagram of the Soft functions. The Soft functions will also affect the switching edges of the Staircase timer function.

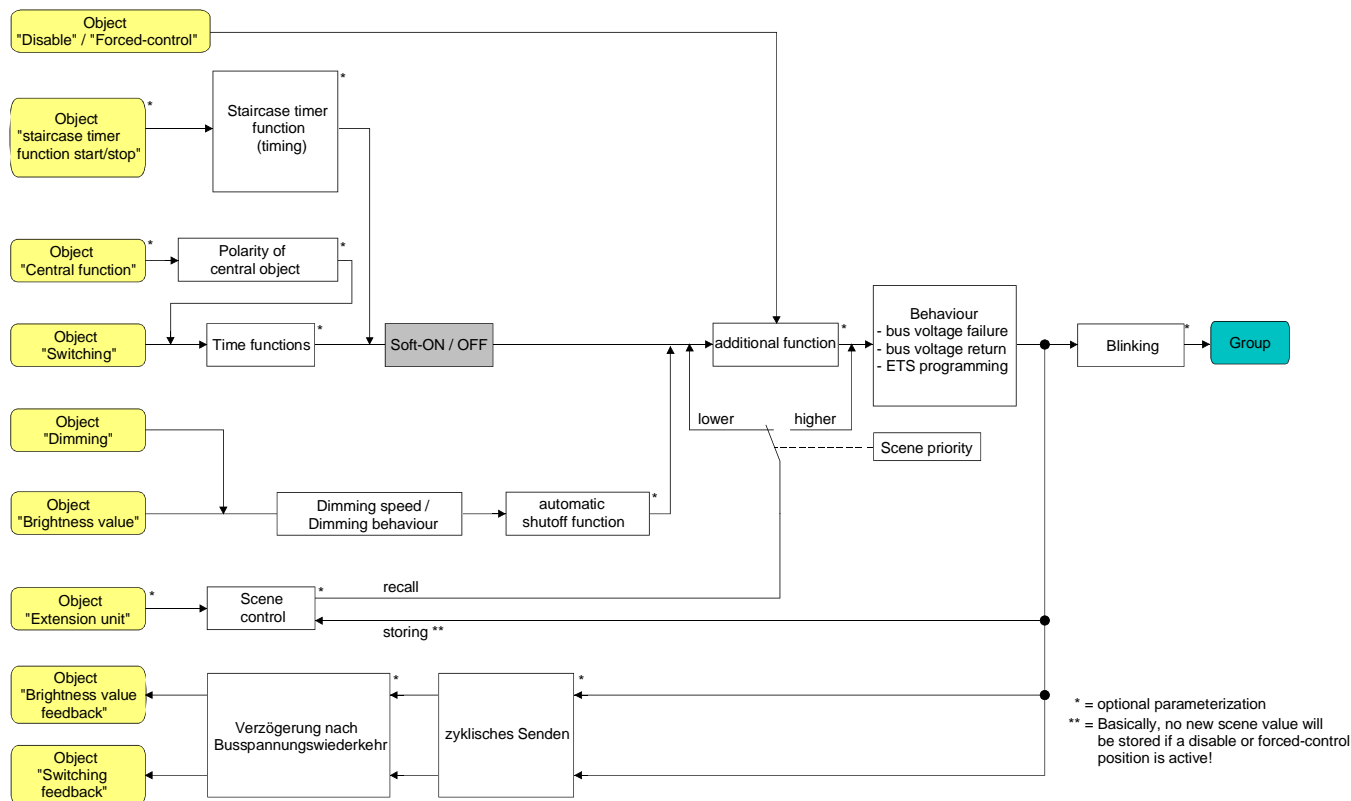

Fig. 23: Functional diagram of the Soft functions

i A DALI group that has been disabled via the bus may also blink depending on the parameterization. An ON and OFF blinking will not be dimmed with the Soft functions.

Setting and enabling the Soft-ON function

The Soft-ON function can be set separately for each group in the plug-in of the DALI Gateway.

- Set the “Soft-ON function ?” parameter in the “Groups - [x] group name – Switch-on/ switch-off behaviour” parameter node to “Yes”.
The Soft-ON function is now enabled. The parameter for the dimming time of the Soft-ON function becomes visible.
- Configure the “Time for Soft-ON (0...100 %)” parameter in the "Groups - [x] group name – switch-on/switch-off behaviour" to the required dimming time.

Setting and enabling the Soft-OFF function

The Soft-OFF function can be set separately for each group in the plug-in of the DALI Gateway.

- Set the "Soft-OFF function" parameter in the "Groups - [x] group name – Switch-on/ switch-off behaviour" parameter node to "Yes".

The Soft-OFF function is now enabled. The parameter for the dimming time of the Soft-OFF function becomes visible.

- Configure the "Time for Soft-OFF (0...100 %)" parameter in the "Groups - [x] group name – switch-on-/switch-off behaviour" parameter node to the required dimming time.

Staircase timer function

The Staircase timer function that can be parameterized separately can be used for implementing time-controlled staircase lighting or functionally similar applications. The Staircase timer function must have been enabled in the "Groups - [x] group name – Staircase timer function" parameter node to make the required communication objects and parameters visible. The Staircase timer function can be parameterized only for the groups 1 ... 16.

The Staircase timer function is controlled via the "Start/Stop Staircase timer function" communication object and depends on the "Switching" object of the group (cf. figure 24). This permits a 'parallel operation' of time and normal control, with always the last command being executed.

A telegram to the "Switching" object during an active Staircase timer function ends the staircase lighting time prematurely and sets the switching status according to the object value (time delays taken into account). Similarly, the switching state of the "Switching" object can be overridden by a Staircase timer function.

In combination with a disable function a time-independent permanent lighting function can also be set up (cf. "Disable function").

The Staircase timer function can be extended by a pre-warning function. The brightness of the DALI group can be reduced during the pre-warning. In acc. with DIN 18015-2, the pre-warning function is designed to warn anyone present in the staircase that the lights will go out shortly.

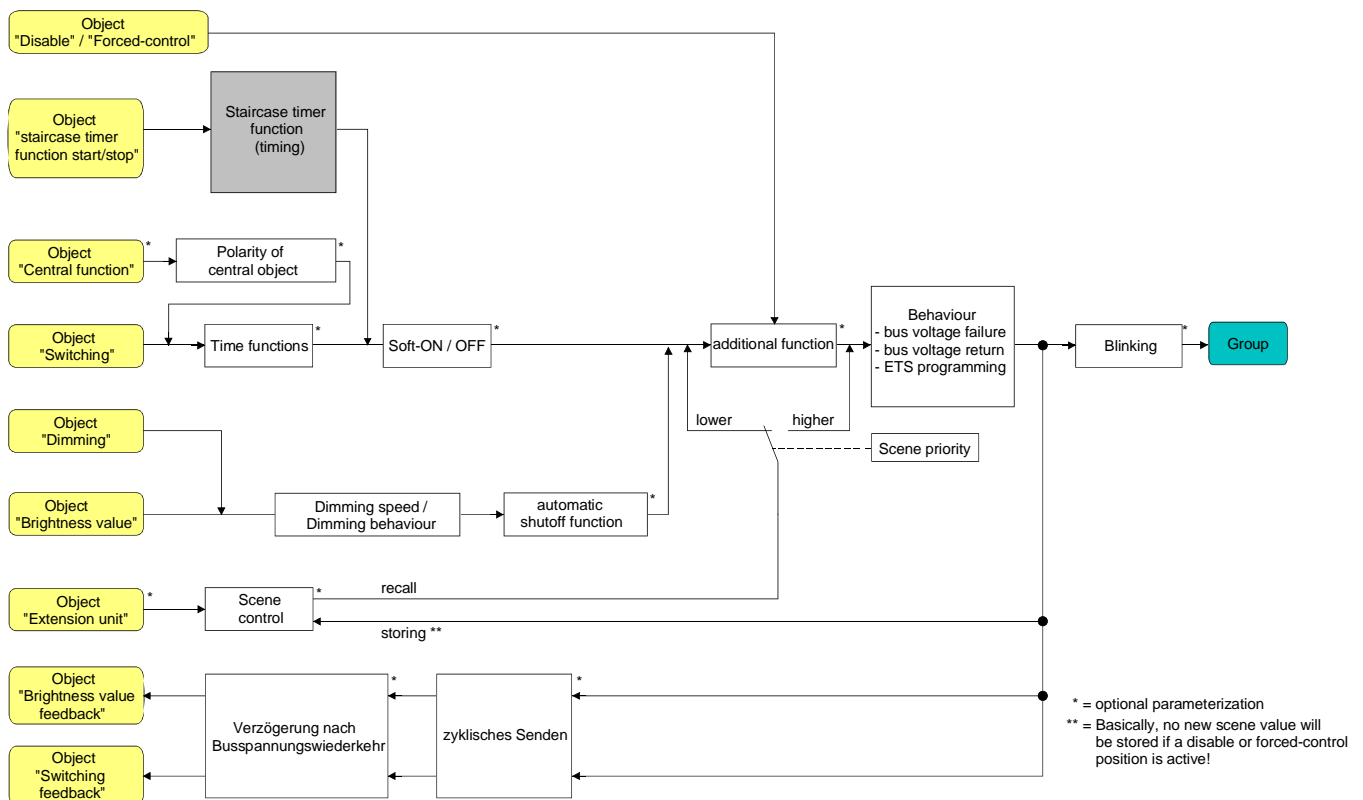

Fig. 24: Functional diagram of the Staircase timer function

Defining the switch-on behaviour of the Staircase timer function

An ON-telegram to the "Staircase timer start / stop" object activates the staircase lighting time (T_{ON}) the duration of which is defined by the "Staircase lighting time" parameter. The DALI group switches to switch-on brightness. At the end of the staircase lighting time, the DALI group switches off or optionally activates the pre-warning time ($T_{prewarn}$) of the pre-warning function (cf. Setting the pre-warning function of the Staircase timer function). Considering a pre-warning function, the Staircase timer function has the switch-on behaviour as shown in Fig. 25.

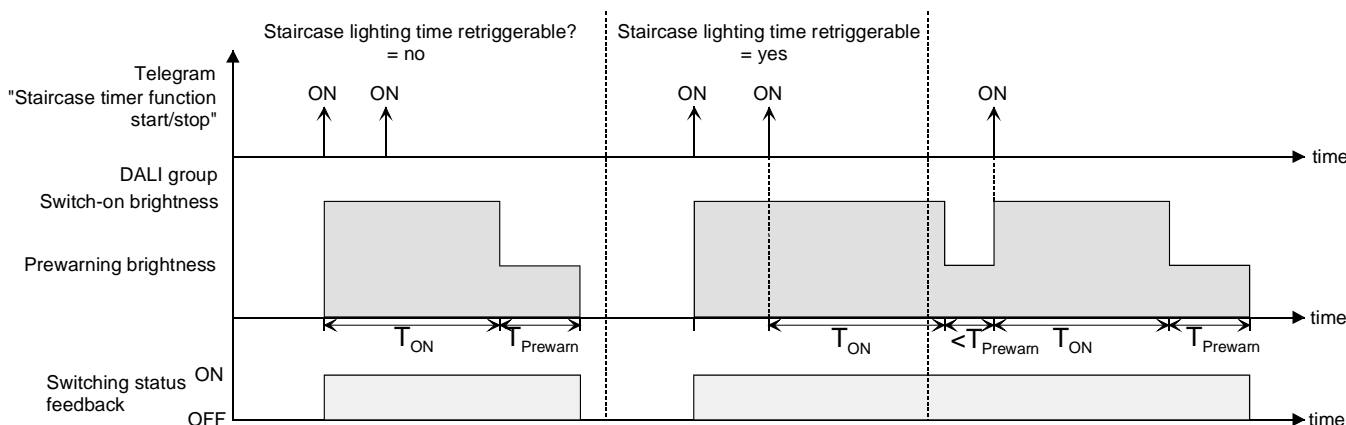

Fig. 25: Switch-on behaviour of the Staircase timer function without Soft functions

In addition, the switch-on can be influenced by the Soft functions of the DALI Gateway. With a possible Soft-ON-delay and Soft-OFF delay function, the Staircase timer function has the switch-on behaviour as shown in Fig. 26.

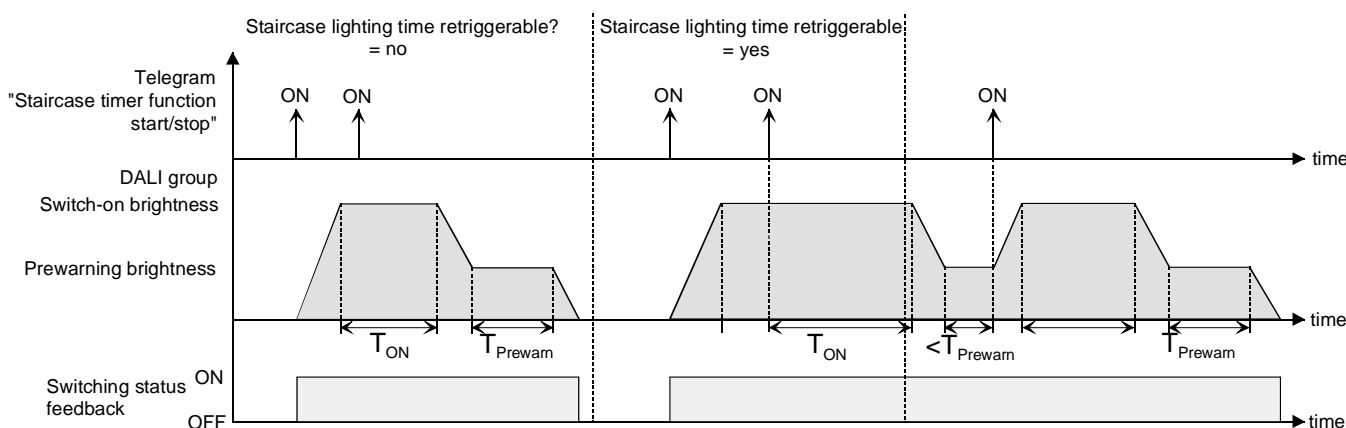

Fig. 26: Switch-on behaviour of the Staircase timer function with Soft functions
(for example: with minimum brightness = 0 %)

- Set the "Staircase timer function ?" parameter in the "Groups - [x] group name – Staircase timer function" parameter node to "Yes".
The Staircase timer function is now enabled. Other parameters will become visible.
 - Configure the required switch-on time of the Staircase timer function with the "Staircase lighting time" parameter.
 - Set the "Staircase lighting time retriggerable ?" parameter to "Yes".
Any ON-telegram received during the ON-phase of the staircase lighting time will retrigger the staircase lighting time completely.
 - Alternatively, set the "Staircase lighting time retriggerable ?" parameter to "No".
ON-telegrams received during the ON-phase of the staircase lighting time will be discarded. The staircase lighting time will not be retriggered.
- ⓘ An ON-telegram received during the pre-warning time will always retrigger the staircase lighting time independent of the "Staircase lighting time retriggerable ?" parameter.

Defining the switch-off behaviour of the Staircase timer function

In a Staircase timer function, the reaction to an OFF-telegram to the "Staircase timer start / stop" object can also be parameterized. Without an OFF-telegram, the devices of the DALI group might switch off after the pre-warning time has elapsed. With a possible pre-warning function, the Staircase timer function has the switch-off behaviour as shown in Fig. 27.

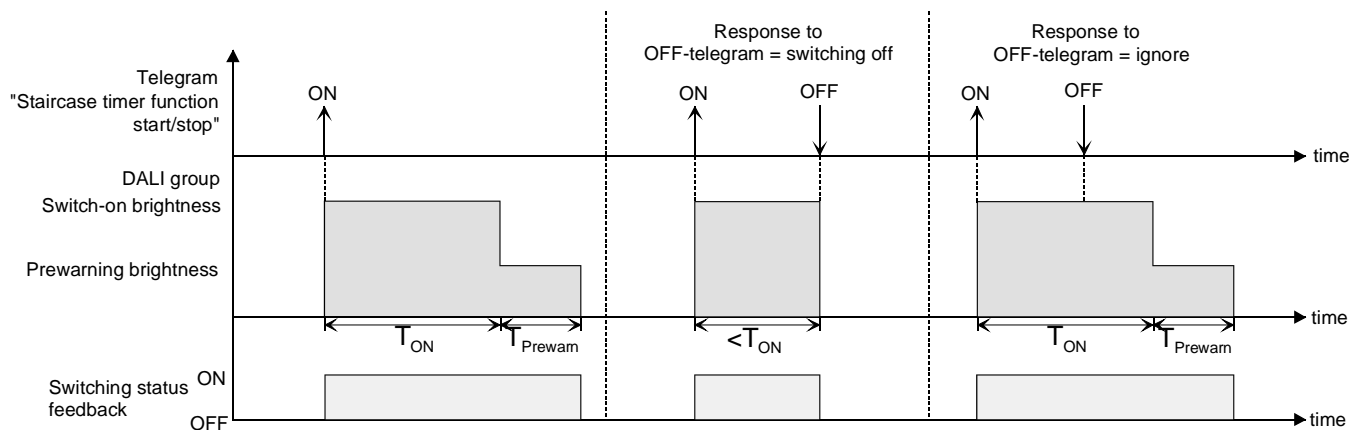

Fig. 27: Switch-off behaviour of the Staircase timer function without Soft functions

In addition, the switch-off can be influenced by the Soft functions of the DALI Gateway. With a possible Soft-ON-delay and Soft-OFF delay function, the Staircase timer function has the switch-off behaviour as shown in Fig. 28.

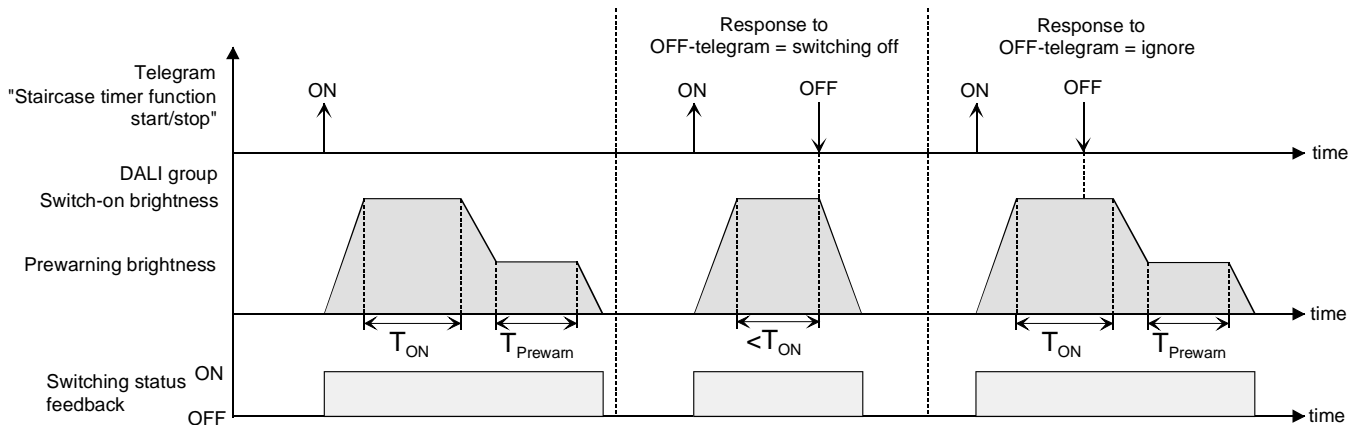

Fig. 28: Switch-off behaviour of the Staircase timer function with Soft functions
(for example: with minimum brightness = 0 %)

The "Response to OFF-telegram" parameter defines whether the staircase lighting time (T_{ON}) of the Staircase timer function can be stopped prematurely. This parameter is found in the "Groups - [x] group name – Staircase timer function" parameter node

The Staircase timer function must be enabled.

- Set the "Response to OFF-telegram" parameter to "Switch-off"

The devices of the DALI group shut off immediately once an OFF-telegram is received via the "Staircase timer start / stop" object during the ON-phase of the staircase lighting time. If the staircase lighting time is stopped prematurely by such a telegram, there will be no pre-warning, i.e. the pre-warning time has not been started.

A shut off is also possible during dimming of a Soft function or during a pre-warning.

- Set the "Response to OFF-telegram" parameter to "Ignore".

OFF telegrams that were received during the ON-phase of the staircase function via the "Staircase timer start / stop" object will be discarded. The staircase lighting time will be completed, if applicable, with a pre-warning.

Setting the pre-warning function of the Staircase timer function

The pre-warning function complies with DIN 18015-2 and is intended to alert anyone present in the staircase that the lights will go out shortly. The devices of the affected DALI group can be set to a pre-warning brightness before the group shuts off completely. Usually, the pre-warning brightness will be less intense than the switch-on brightness. The parameters for the pre-warning time (T_{prewarn}) and the pre-warning brightness can be set separately (cf. Figure 29).

The pre-warning time is added to the staircase lighting time (T_{ON}). The pre-warning time has an effect on the value of the feedback objects so that the value "0" is tracked in the feedback object only after the pre-warning time has elapsed.

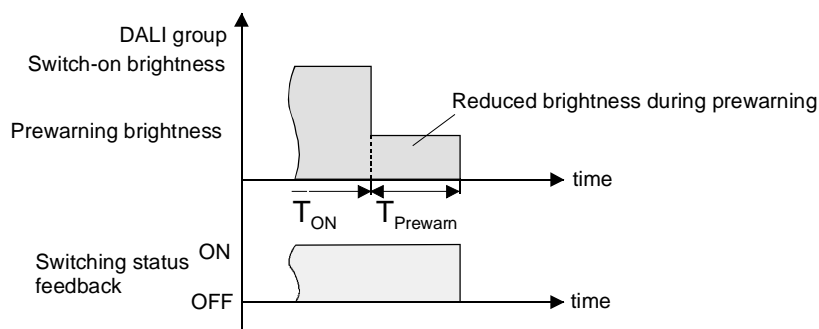

Fig. 29: The pre-warning of the Staircase timer function without Soft-ON function

In addition, the pre-warning function can also be extended by the Soft-OFF function. With a possible Soft-OFF-delay, the switch-off behaviour of the staircase lighting function shows the switch-off behaviour after the pre-warning time as illustrated in fig. 30.

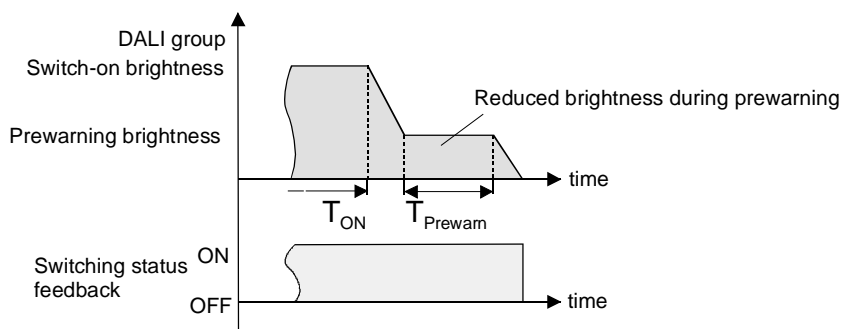

Fig. 30: The pre-warning function of the Staircase timer function with Soft-OFF function
(for example: with minimum brightness = 0 %)

- ❶ The pre-warning brightness must not necessarily be smaller than the switch-on brightness. Basically, the pre-warning brightness can be parameterized to values that lie between the maximum and minimum brightness.

The Staircase timer function must be enabled.

- Set the "Activate pre-warning time ?" parameter in the "Groups - [x] group name – Staircase timer function " parameter node to "Yes".

The pre-warning function is now enabled. The desired pre-warning time (T_{prewarn}) can now be set.

- Set the "Reduced brightness during pre-warning time" parameter in the "Group - [x] group name – Staircase timer function" parameter node to the desired brightness value.

The DALI group will be set to the parameterized brightness value within the pre-warning time.

- ❗ An ON-telegram sent to the "Staircase timer start / stop" object during an active pre-warning function will stop the pre-warning time. The staircase lighting time will always be restarted (independent of the "Staircase lighting time retriggerable ?" parameter). The "Response to OFF-telegram" parameter is also evaluated during the pre-warning time so that an active pre-warning can be stopped prematurely by switching off.

Setting the behaviour of the Staircase timer function after bus/ mains voltage return

Optionally, the Staircase timer function can be automatically started after a bus or mains voltage return. The Staircase timer function must be enabled.

- Set the "Response to bus voltage return" parameter in the "Groups - [x] group name" parameter node to "Start Staircase timer function".

The staircase lighting time of the Staircase timer function is started immediately after bus or mains voltage return.

- ❗ When using this setting make sure that the Staircase timer function has been programmed and enabled beforehand. In case the Staircase timer function has not been enabled, this setting will produce no reaction after the return of bus/ mains voltage.
- ❗ The parameterized behaviour will only be executed, if no forced-control position has been activated after a bus voltage return.

4.2.4.5 Scene function

The DALI Gateway permits the creation of up to 16 scenes of its own. Each scene can be assigned an available DALI group. A scene brightness value can also be parameterized and stored in the DALI Gateway for each assigned group. Thus, the devices of the DALI groups can also be integrated in scene controls.

The individual scenes must be created as necessary in the “Scenes” parameter node. Scenes can be created by selecting the “Scenes” node in the tree structure view followed by the “New” command via the context menu (right mouse click).

After selecting a created scene in the tree structure view the scene configuration appears in the right subwindow of the plug-in. (cf. Figure 31).

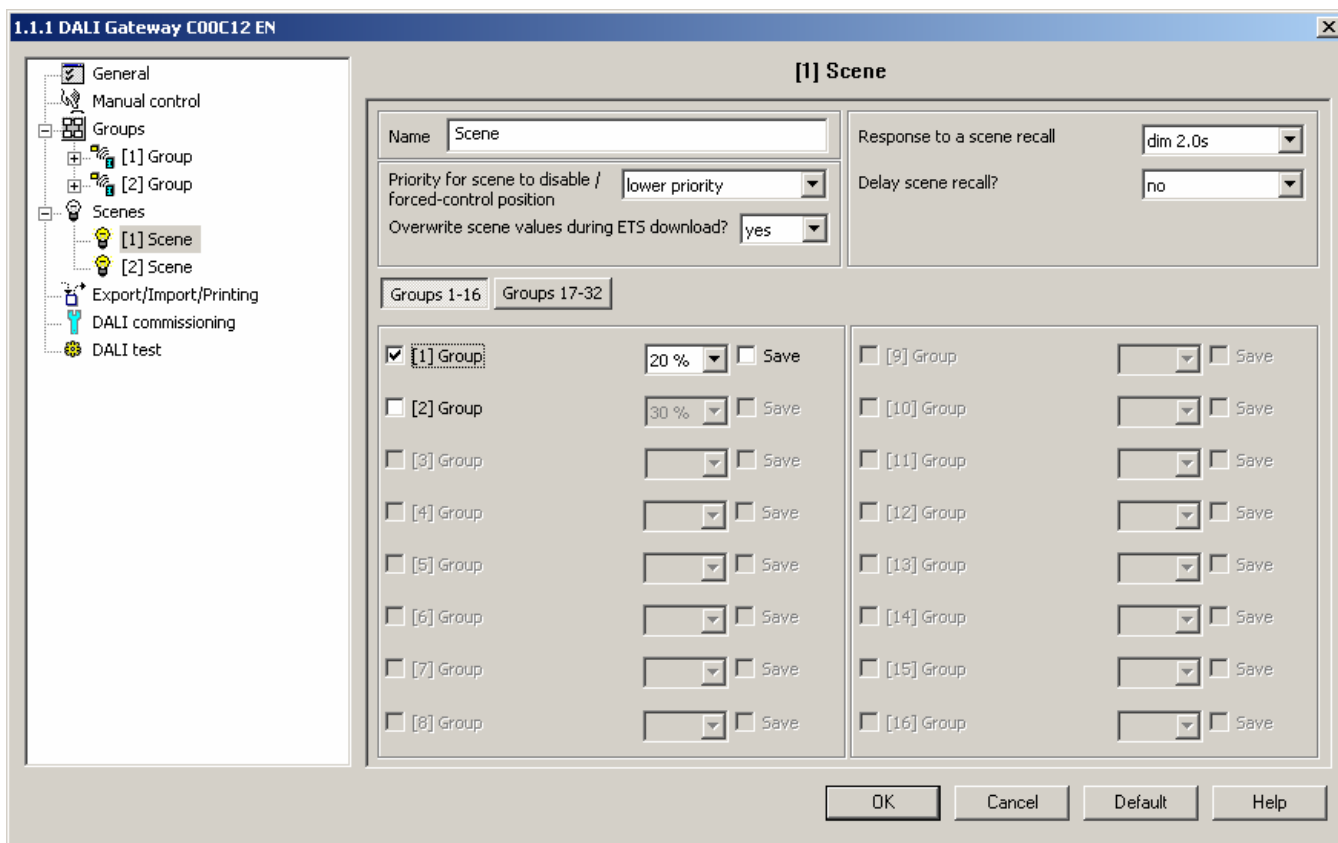

Figure 31: Configuration page of a scene
for example: two created scenes and two DALI groups

Created groups can also be copied via the “Copy” command in the context menu of a scene node and inserted as a new scene in the “Scenes” node. The parameter settings of the copied group will be adopted.

It is also possible to insert a previously copied scene into an already existing scene. All parameter settings of the existing scene will be adopted by the copied scene.

Created scenes can be deleted at any time by selecting a scene and executing the "Delete" command in the context menu.

Each scene can be assigned a name. The scene must be selected and opened via the "Rename" command in the context menu. It is recommended to assign each scene a unique name (e.g. "Lecture desk", "Meeting large", etc.). The name may not exceed 28 characters and may include alphanumerical as well as special characters.

For better orientation and differentiation of the individual scenes, the name will only be shown in the plug-in. A scene name can also be edited in the parameter configuration of a scene via the "Name" parameter.

The scene brightness values are recalled or stored via a separate scene extension object affecting several channels by means of extension telegrams. The data point type of the extension object makes it possible to control each scene separately via their fixed scene number (1...16). Optionally, each scene recall can also be delayed.

A scene recall overrides a set brightness value via the "Brightness value" object as well as a switching or dimming operation via the "Switching", "Switching central function" and "Dimming" objects of a group. A Staircase timer function will also be overridden by a scene recall. The priority of the scene function to the disable or forced-control position functions of a group can be parameterized for each scene. That makes it possible to have a scene recall override a disable or forced-control position function. Alternatively, a scene can have a lower priority preventing disable or forced-control position functions to be overridden by a scene recall.

A function overridden by a scene recall will be re-executed if the function has been updated via the KNX/EIB.

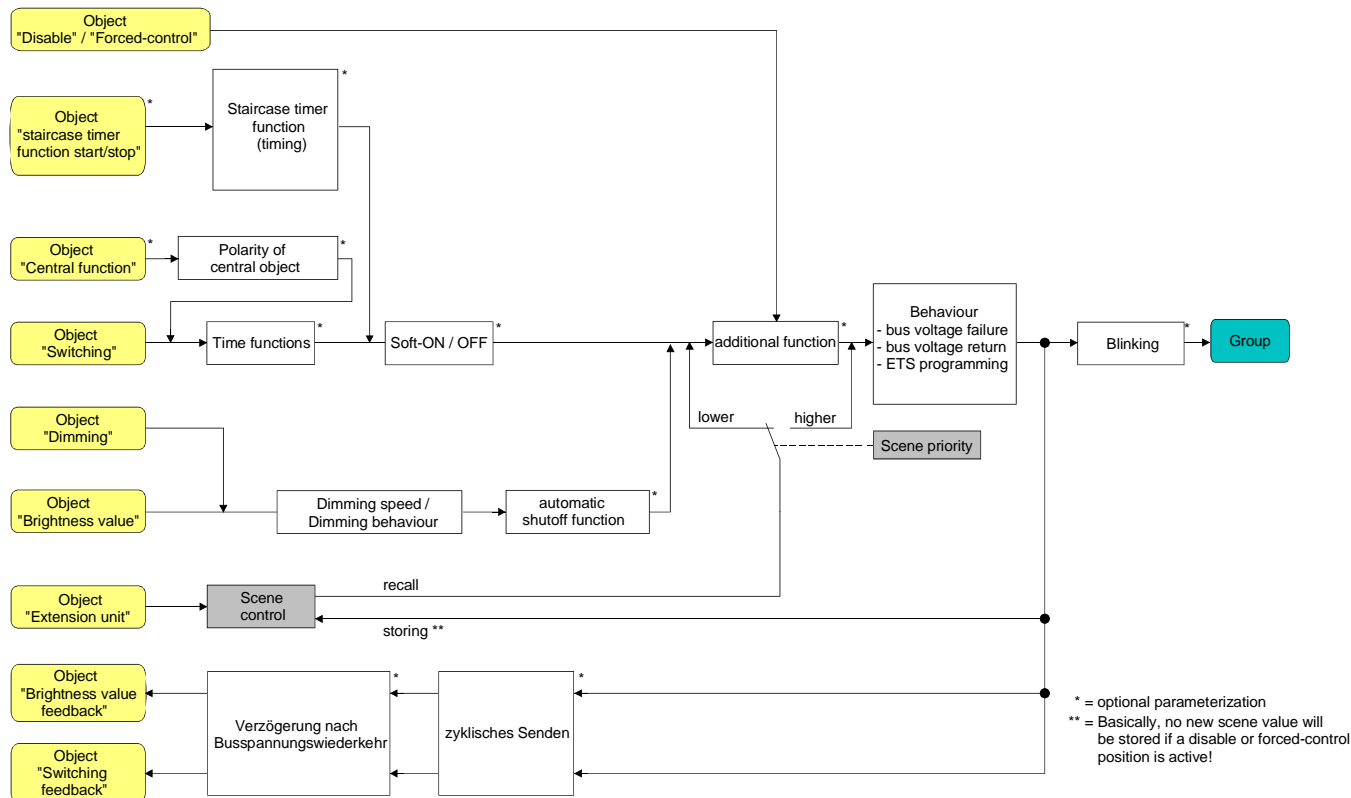

Fig. 32: Functional diagram of the scene function

Configuring the group assignment of a scene

All groups can be assigned to a scene without any restrictions. Each group can be independently assigned by activating the check box in front of the scene configuration (cf. Figure 33). Groups that have not been activated by the check box are not assigned to the scene. All groups of the DALI Gateway that are not created are masked in grey and cannot be edited.

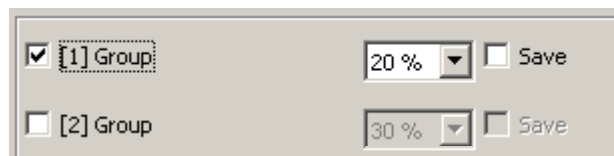

Figure 33: Part of the group assignment of a scene

For better clarity the available groups (1...32) are divided into two pages in the subwindow of the scene configuration which can be separately shown. Pressing the "Groups 1-16" and "Groups 17-32" buttons within the scene configuration window allows for the switching between the pages.

- Activate the check box of those DALI groups that are to be assigned to the selected scene. The activated groups are now assigned to the scene. The group-oriented parameters of the scene brightness value and the scene memory function will be enabled.

Setting the scene brightness values

The brightness value to be set in case of a scene recall must be specified for each DALI group that has been assigned to a scene.

A group must be assigned to a scene in order to be able to edit the scene brightness value of a group.

- Specify the required scene brightness value for each DALI group assigned to the scene in the "Scene - [x] scene name" parameter node.
When recalling a scene the brightness value parameterized in each case will be set for the devices of a DALI group.
- ❗ When programming with the ETS the parameterized brightness values will be accepted into the DALI Gateway only if the "Overwrite scene values during ETS download" parameter has been set to "Yes".
- ❗ The scene brightness value that can be selected in the ETS plug-in must be within the limits of the maximum and minimum brightness parameterized for each group.
- ❗ The same DALI devices can be assigned different groups several times during the DALI commissioning (Multiple assignment: e.g. electronic ballast device 1 is assigned to group A and group B). If groups (e.g. A & B) have been assigned to a scene and if these groups include the same devices (e.g. electronic ballast device 1), there will be a conflict in case of different scene brightness values. In this case, the multiple assigned devices will be set to the scene brightness value of the group with the highest number.

Setting the storage behaviour for the scene function

Upon reception of a storage telegram the current brightness values for all the DALI groups assigned to a scene can be internally stored via the scene extension object. The brightness values to be stored prior to the storing can be influenced by all functions of the individual groups (e.g. switching, dimming, manual control).

A group must be assigned a scene in order to be able to edit the scene storage behaviour of the group.

- Activate the "Save" check box for the DALI groups in the "Scene - [x] Scene name" parameter node that are to respond to the memory function (cf. Figure 33).

The memory function is now activated for the DALI group. On reception of a memory telegram via the "Extension unit" object, the current brightness value for this group will be internally stored.

- Deactivate the "Save" check box for the DALI groups in the "Scene - [x] Scene name" parameter node that are to respond to the memory function (cf. Figure 33).

The memory function is now deactivated for the DALI group. A memory telegram received via the "Extension unit" object will be discarded.

i When saving scene brightness values they will be permanently and internally stored in the DALI Gateway and will overwrite the value of a group that was programmed last via the ETS. The brightness values parameterized in the ETS will be accepted into the DALI Gateway only if the "Overwrite scene values during ETS download" parameter has been set to "Yes".

i Independent of the set scene priority no new scene values will be stored for an assigned group if a disable or a forced-control position has been activated in this group.

Setting the scene priority

The priority of the scene function over the disable or forced-control position functions of a group can be parameterized for each scene. That makes it possible to have a scene recall override a disable or forced-control position function of an assigned DALI group. Alternatively, a scene can have a lower priority preventing disable or forced-position functions to be overridden by a scene recall.

The scene priority can be configured separately for each created scene.

- Set the "Priority for scene to disable / forced-control position" parameter in the "Scenes - [x] Scene name" parameter node to „Lower priority“.

The scene now has a lower priority to the additional functions of the assigned groups. A scene recall or a scene memory will be prevented for the groups that have an additional function activated.

- Set the "Priority to disable scene / forced-control position" parameter in the "Scenes - [x] Scene name" parameter node to „Higher priority“.

The scene now has a higher priority over the additional functions of the assigned groups. A scene recall or a scene memory will always be executed when receiving a scene extension telegram..

- ❗ Independent of the set scene priority with enabled scene memory function, no new scene values will be stored for an assigned group if a disable or a forced-control position has been activated in this group!
- ❗ At the end of a disable/forced-control position with "Tracked brightness value" setting selected: At the end of the additional function the scene recall that was received during the forced function will not be tracked.
- ❗ When set to "Higher priority": A scene recall will not statically lock the secondary functions of a group. The higher priority only defines that during the scene recall the scene brightness value will be set and override the brightness value previously specified. After the recall of a scene it is possible to have the scene brightness value subsequently be changed again by other functions of the Gateway (e.g. while terminating an additional function or by switching or dimming).

Setting the ETS download behaviour for the scene function

During storage of a scene, the scene values are stored permanently in the device (cf. "Setting the storage behaviour for scene functions"). To prevent the stored values from being replaced during ETS programming of the application or parameters by the originally programmed scene switching states, the DALI Gateway can inhibit the overwriting of scene values. As an alternative, the original values can be reloaded into the device during each programming run of the ETS.

The ETS download behaviour can be separately configured for each scene.

- Set the "Overwrite scene values during ETS download" parameter in the "Scenes - [x] scene name" parameter node to "Yes".
During each ETS programming of the application or parameters, the scene values parameterized in the ETS will be programmed into the Gateway. If applicable, the scene values stored in the device by means of a memory function will be overwritten.
 - Set the "Overwrite scene values during ETS download" parameter in the "Scenes - [x] scene name" parameter node to "No".
If applicable, the scene values stored in the device with a memory function will be maintained. If no scene values have been stored, the switching scene brightness values last programmed in the ETS remain valid.
- ❗ When the Gateway is commissioned for the first time, this parameter should be set to "Yes" so that the scenes are initialized with valid scene values.

Setting a scene recall delay for the scene function

Optionally, the evaluation of each scene recall can also be delayed. This allows, for example to have dynamical scene sequences to be configured in combination with several actuators or Gateways with cyclical scene telegrams.

The scene recall delay can be separately configured for each scene.

- Set the "Delay scene recall ?" parameter in the "Scenes - [x] scene name" parameter node to "Yes". Parameterizes the delay time.
The delay time is now activated. The delay affects only the scene recall of the relevant scene. The delay time will be started on arrival of a recall telegram. The corresponding scene will be recalled and set to the corresponding scene brightness value only after this time has elapsed.
 - Set the "Delay scene recall ?" parameter in the "Scenes - [x] scene name" parameter node to "No".
The delay time is now deactivated. A scene recall will be executed without delay immediately after the reception of a scene recall telegram.
- ⓘ Each scene recall telegram will restart and then also retrigger the delay time. If a new scene recall telegram is received while a delay is active (scene recall not yet executed), the old (and not yet recalled scene) will be discarded and only the scene received last will be executed.
- ⓘ The scene recall delay has no influence on the storage of scene values. A scene memory telegram within a scene recall terminates the delay time and thus the scene recall.
- ⓘ In case of bus or mains voltage failure all time functions will be stopped. That will abort all scene recalls that are currently being delayed and causes a scene recall received shortly before a bus or mains voltage failure to get lost if the corresponding delay time has not yet lapsed. Even if a higher-priority function has been activated (e.g. manual control, forced-control position function, disable function) a delayed scene recall for the relevant groups will be completely aborted.

Setting the response to a scene recall

A scene can be configured whether the light intensity dims to or instantly jumps to the scene brightness values for the assigned groups. Thus a scene recall can be executed independent of the adjusted dimming response of the groups.

The response to a scene recall can be separately configured for each scene.

- Set the "Response to a scene recall?" parameter in the "Scenes - [x] scene name" parameter node to "Jump to".

The scene brightness values of the relevant scene will be immediately jumped to in case of a recall.

- Set the "Response to a scene recall" parameter in the "Scenes - [x] scene name" parameter node to "Dim". At the same time, define the time required to dim to the scene brightness value.

The brightness will be dimmed to the scene brightness values of the relevant scene. The dim fading is now activated. The time parameter defines the time of the dimming required to reach the scene brightness value. The brightness value of a group that starts with the dimming has no significance. Thus the dimming in case of a scene recall always requires the exact specified time.

4.2.4.6 DALI commissioning

Starting the DALI commissioning

The plug-in embedded in the ETS 3 makes it easy to configure the DALI Gateway as well as to create and parameterize the required DALI groups. Also, the plug-in allows the DALI to be commissioned via the KNX/EIB bus line. No additional tool and no special programming link is required.

Important note:

The DALI commissioning must be executed after all groups have been created and configured at the KNX/EIB (all required parameter must be preset and all group addresses be assigned). It is also necessary to program the DALI Gateway with the ETS 3 at least once prior to the DALI commissioning so that the Gateway has been physically addressed and the application program has been loaded (cf. Chapter 2.4 "Commissioning").

Once all the requirements have been met, the "DALI commissioning" on the parameter page of the plug-in with the same name can be executed. The commissioning environment becomes visible in the right subwindow of the plug-in after opening the commissioning page and a successfully established communication with the DALI Gateway (cf. figure 34).

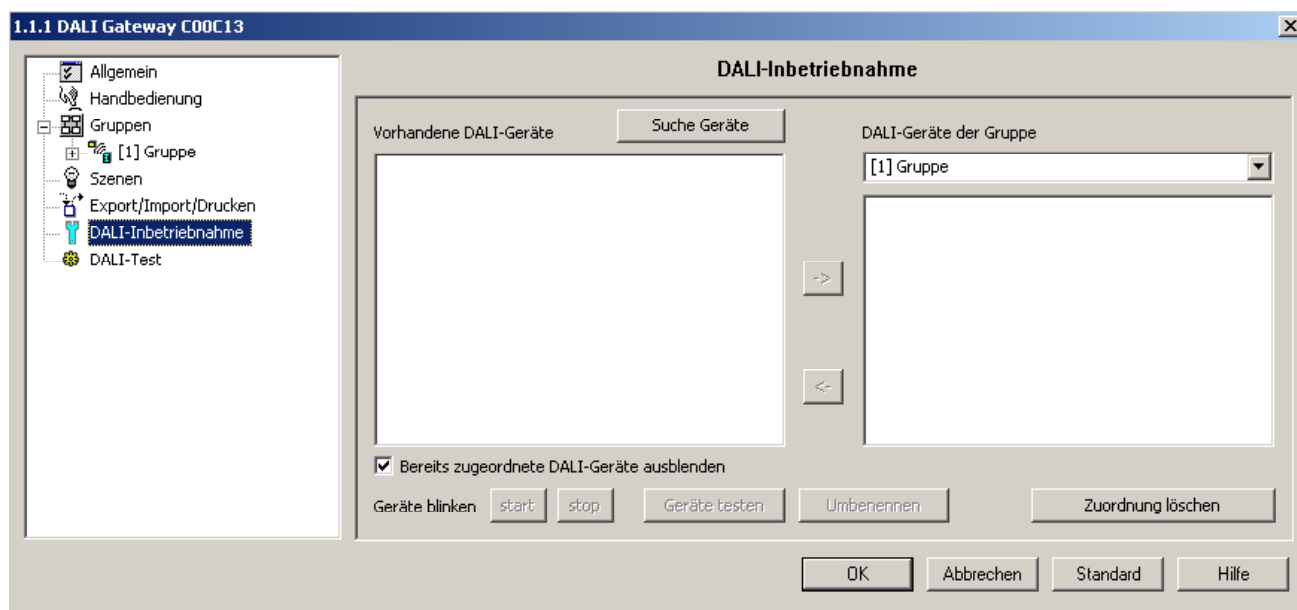

Figure 34: DALI commissioning environment in the ETS 3 plug-in. Example: application program of version "0.4" or "1.4"

When opening the commissioning environment the plug-in first attempts to communicate with the DALI Gateway via the bus connection of the ETS (cf. figure 35 on the following page) and verifies whether a DALI commissioning is possible. For this reason the DALI Gateway must be connected to the KNX/EIB and the bus as well as the mains voltage supply must be switched on if the DALI commissioning is called up. In addition the ETS 3 must have a working communication interface to the bus (e.g. RS-232 or USB).

i The Gateway does not verify the operability of the DALI line in this situation.

In case a connection link to the DALI Gateway can not be established in this situation, the plug-in will abort the commissioning prematurely and will not show the commissioning environment. The following lists the possible causes for a faulty connection and their corresponding remedies...

- Cause: no functioning ETS 3 communication interface to the KNX/EIB.
Remedy: verify the connection in the ETS 3 under "Tools – Options – Communication" . If needed, set up the connection.
- Cause: the physical address and the application program have not been programmed via the ETS 3.
Remedy: close the plug-in and program the physical address and the application program first.
- Cause: KNX/EIB bus voltage at the DALI Gateway or at the local data interface is not connected or switched on.
Remedy: connect and switch on bus voltage.
- Cause: mains voltage supply on the DALI Gateway is not switched on.
Remedy: switch on the mains voltage supply on the Gateway.

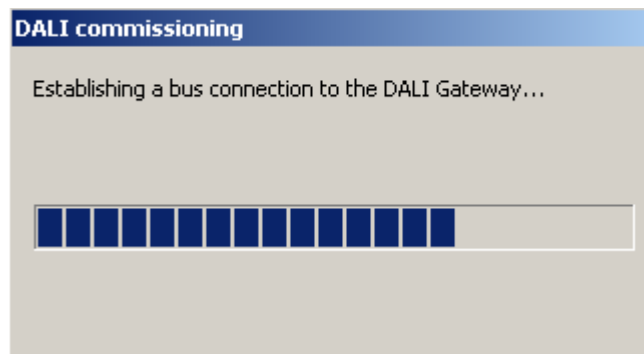

Figure 35: Establishing a bus connection to the DALI Gateway for the DALI commissioning

Once completed the DALI commissioning can proceed, for example, by assigning the DALI devices to the groups.

Assigning DALI devices to groups

During the DALI commissioning, the DALI devices (max. of 64) will be assigned to the groups of the Gateway. It is the group assignment that makes it possible to control the DALI devices individually (individual assignment – only one device in the group) or collectively (multiple assignment – several devices in a group) via the KNX/EIB.

For the groups 1...16 of the DALI Gateway it is possible to assign several DALI devices to a group (multiple assignment). The addressing at the DALI takes place via group addresses that the DALI Gateway configures as "hidden" to the user. The DALI Gateway handles them independently. When completing the DALI commissioning, all relevant devices will be automatically programmed.

Only individual assignments can be parameterized for the groups 17...32. Each group can be assigned only one DALI device. In this case, the DALI addressing takes place via an internally created individual address. Only one device can be uniquely addressed. This individual address is also automatically assigned by the DALI Gateway during the DALI commissioning.

In principle, it is also possible to assign a DALI device to several groups. In order to simplify the device assignment, the ETS application program of version "0.4" or "1.4" provides an option in the plug-in to prevent an assignment of DALI devices to several groups. This makes the device assignment easier and more clearly. Alternatively, an assignment of devices to several groups can be permitted with this application program version, if required.

The application program of version "0.2" or "1.2" always allows the assignment of DALI devices to several groups. It is recommended to use the application program of version "0.4" or "1.4" when configuring the project in the ETS.

The commissioning environment of the plug-in is divided into two windows. The left window lists the devices found in the DALI system. The right window displays the created groups. This is where the DALI devices are assigned to the groups.

Searching for DALI devices

During the first commissioning all connected DALI devices have to be searched for and identified first. In case the DALI Gateway had been in use at least once, the searching will only be required if new devices have been added to the DALI system or if the ETS product database has been modified thus completely reconfiguring the device. The DALI commissioning will be completed by writing (and thus storing) the commissioning parameters (identified devices with short address, names of the devices, group assignment) into the ETS database. When the commissioning environment is started the stored data will be displayed.

During the first commissioning no DALI devices will be displayed in the left window. In order to continue the commissioning all devices connected to the DALI line will have to be searched for first.

For the DALI Gateway to find and identify all DALI devices during the device search the DALI system must be fully connected and switched on.

In addition, the mains voltage of the DALI Gateway must be switched on.

- Click on or select the “Search for devices” button in the commissioning environment.
The DALI Gateway will search for existing DALI devices. The Gateway scans the DALI line progressively and will identify the connected devices one after another. The search can take some time depending on the number of connected DALI devices. The plug-in will show the progress made during the search (cf. figure 36). The plug-in differentiates whether a DALI device has been identified for the first time or whether it has been identified before during a commissioning. Taking this distinction into account the plug-in displays the devices found while the search is still in progress. If the DALI is commissioned for the first time all devices found will be identified as 'new device'. All identified devices (older ones as well as new ones) will be listed in the left window of the commissioning environment once the search has been completed. Each identified DALI device will be labelled with a unique short address which is displayed in front of the device name ([1]...max. [64] / cf. figure 37 on the next page).



Figure 36: Progress bar during a DALI device search

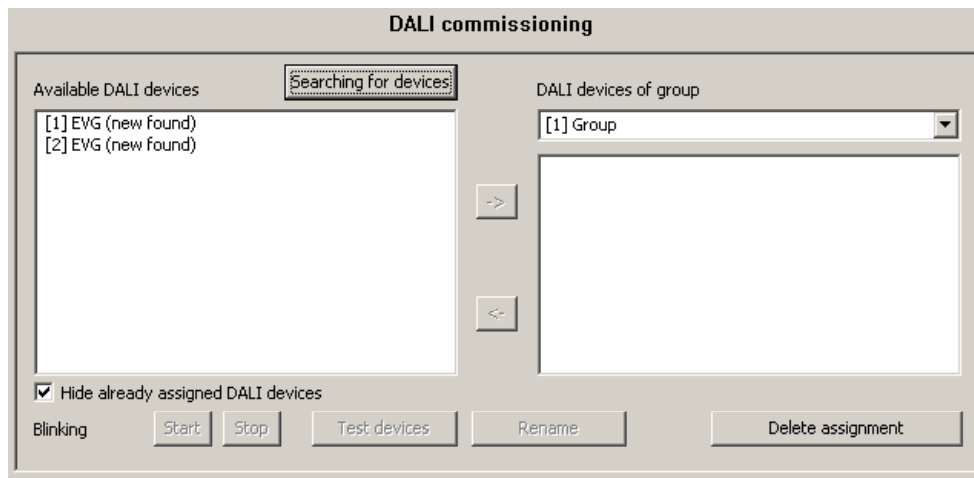

Figure 37: An example of the device list after a search
(the example shows two newly identified electronic ballast devices)

- i** The DALI Gateway will not detect an error in the DALI line during a device search. In case of a short-circuit, for example, the Gateway will attempt to establish a cyclical DALI communication. Since it will fail in its attempt, the plug-in will not stop searching for devices. In case of a cable break, for example, the DALI devices will not be detected.
- i** By default, the plug-in of the DALI Gateway will identify the names of the devices found for the first time as “Electronic ballast device (new device)”. Each DALI device will be named “Electronic Ballast Device”. The device can later be renamed. The designation “new device” will be displayed only until either the device has been renamed or until the commissioning environment of the plug-in has been quit. For this reason it is recommended to assign a unique name immediately after the device search has been completed.
- i** During the device search all connected DALI devices will switch to their implemented minimum brightness. That allows to determine whether the device actually work and whether they respond to the device search.

Assigning names to DALI devices

All new DALI devices should be renamed after the device search so that the individual devices can be clearly identified and to make it easier to find them in the DALI installation. Known devices can also be renamed any time.

- Click on or select a device listed in the left window of the commissioning environment.
- Click on the "Rename" button.

A dialogue box will open for renaming the device. Names cannot have more than 28 characters. The name may include alphanumerical as well as special characters. It is recommended to assign a unique name to each device (e.g. “Light 1 Window South”, “Light 2 Window South”, Light 1 Office Middle” etc. / cf. figure 38 on the following page).

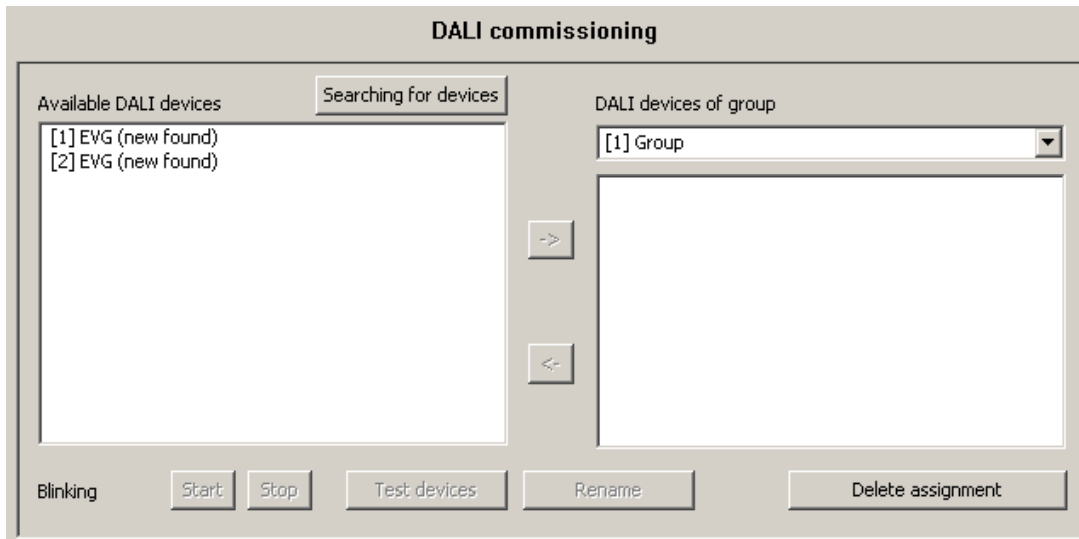

Figure 38: Assigning a name to identified devices

- i** The short address of a device shown in square brackets in front of the device name cannot be edited.
- i** The short addresses of the identified devices are assigned randomly. Several test functions available in the plug-in can be used to detect during the name assignment which device is actually identified in the list entry. The “Start”, “Stop”, and “Test devices” buttons running the test functions are found in the lower margin of the commissioning environment (cf. figure 38). The devices to be tested have to be selected in the left partition first.

Clicking on the “Start” button will start a periodical blinking (approx. 0.2 Hz) of the selected devices. Blinking devices are identified in the list box by the addition of "--> Blinking". The blinking will cease only by clicking on the “Stop” button.

Clicking the “Test devices” button will open the extended testing environment of the DALI commissioning. At this point the devices that have previously been selected can be switched on and off. In addition, a signal blinking periodically or in defined intervals can be transmitted to the applicable devices.

Assigning groups

After all devices connected to the DALI Gateway have been identified and renamed the devices can be assigned to the created groups.

For this purpose the DALI devices listed in the left window have to be moved into the right window of the selected group. The assignment can be done by activating the "->" button between the two subwindows. An assignment can be cancelled by selecting an assigned device and by activating the "<-" button.

Using the same procedure it is also possible to have several devices simultaneously assigned or cancelled.

It is possible to assign devices to more than just one group. The DALI commissioning environment of the ETS plug-in differs depending on the application program as follows...

In case of application programs of version "0.4" or "1.4" (recommended), it is initially only possible to assign a DALI device to only one group. This makes the device assignment easier and more clearly and the explicit assignment does not result in group overlappings. The check box "Hide already assigned DALI devices" in the commissioning dialog is checked in this case (cp. fig. 39). This is the default configuration of the plug-in.

Alternatively, the multiple group assignment of a DALI device can be activated, if required. To do so, the check box "Hide already assigned DALI devices" can be deselected.

The application programs of version "0.2" or "1.2" always allow for a multiple assignment. No difference is made whether a DALI device may only be assigned to a group once or several times. The check box "Hide already assigned DALI devices" is not available.

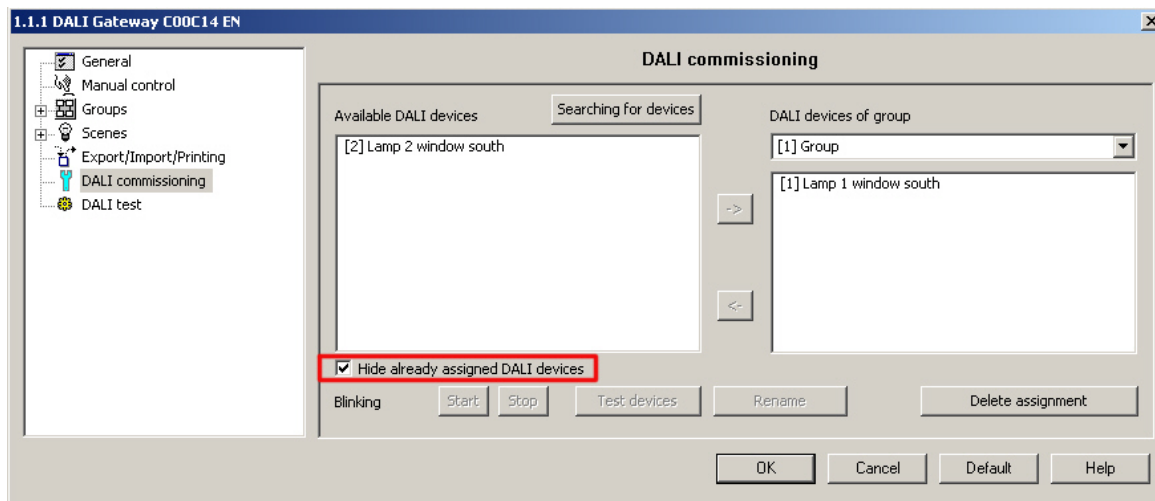

Figure 39: Check box "Hide already assigned DALI devices" in the DALI commissioning dialog of the ETS plug-in

Procedure for the group assignment when using the application program of version "0.4" or "1.4" with the ticked check box "Hide already assigned DALI devices" (default):

- Select the required group for the devices in the right subwindow of the DALI commissioning environment (cp. fig. 40).

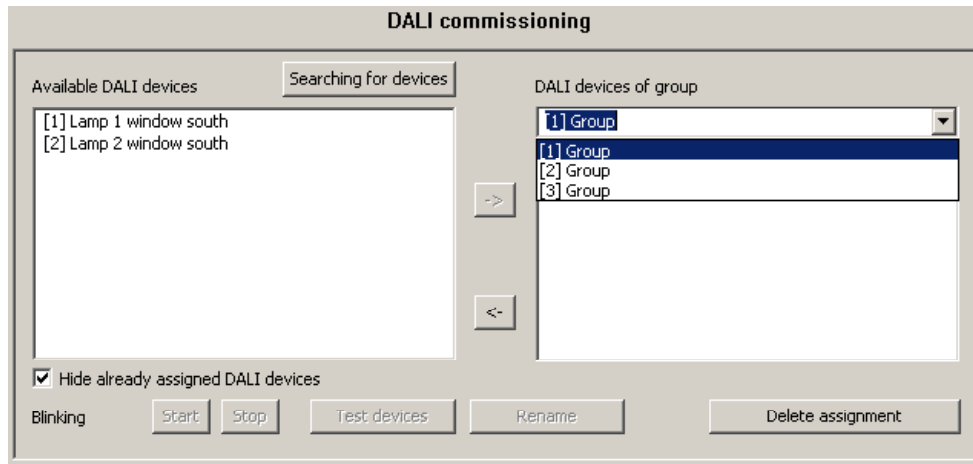

Fig. 40: Select group

- Assign one or several existing DALI devices to the group.
The assigned devices will be removed from the list box in the left subwindow and will appear for the selected group in the right subwindow (cp. fig. 41).

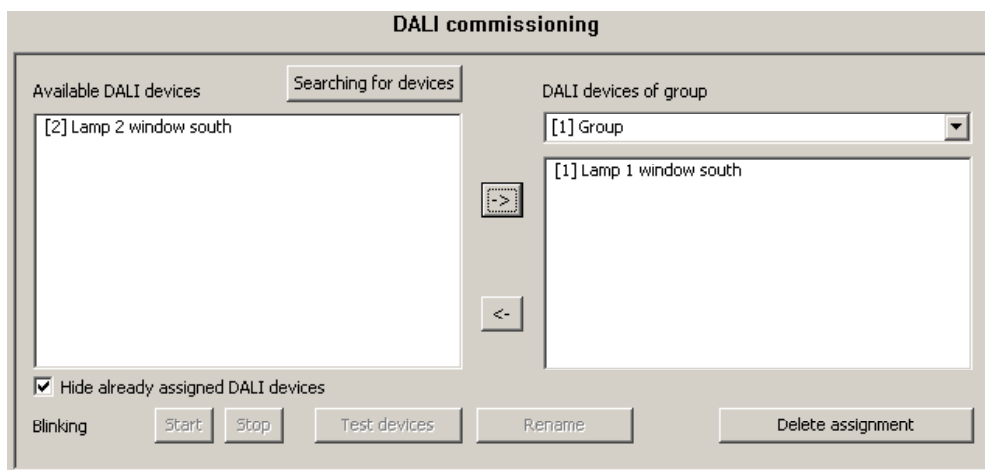

Fig 41: Assigning a device to a group

- Select, if applicable, another group from the right subwindow.
The left subwindow will only display the remaining and unassigned devices.
- Assign yet another or several of the remaining DALI devices to the group.
The assigned devices will be removed from the list box in the left subwindow and will be displayed for the selected group in the right subwindow.
- If applicable, carry out assignments for other groups as described.

Procedure for the group assignment when using the application program of version "0.2 " or "1.2" or when using the application program of version "0.4" or "1.4" with a deleted check box "Hide already assigned DALI devices ":

- Select the required group that will have devices assigned to them from the right subwindow of the DALI commissioning environment (cp. figure 42).

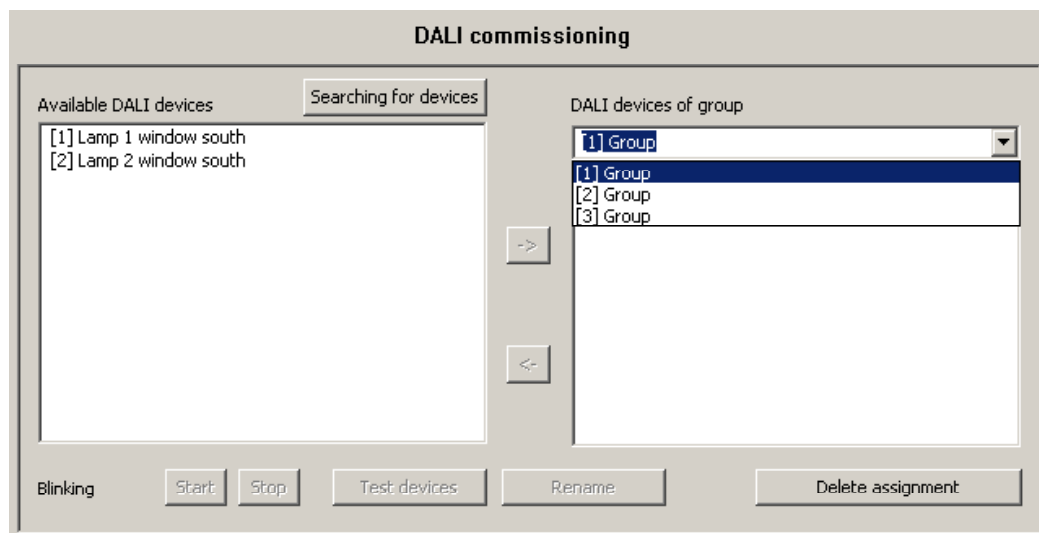

Figure 42: Selecting a group

- Assign one or several available DALI devices to the group.
The assigned devices will be removed from the list box in the left subwindow and will appear for the selected group in the right window (cf. figure 43).

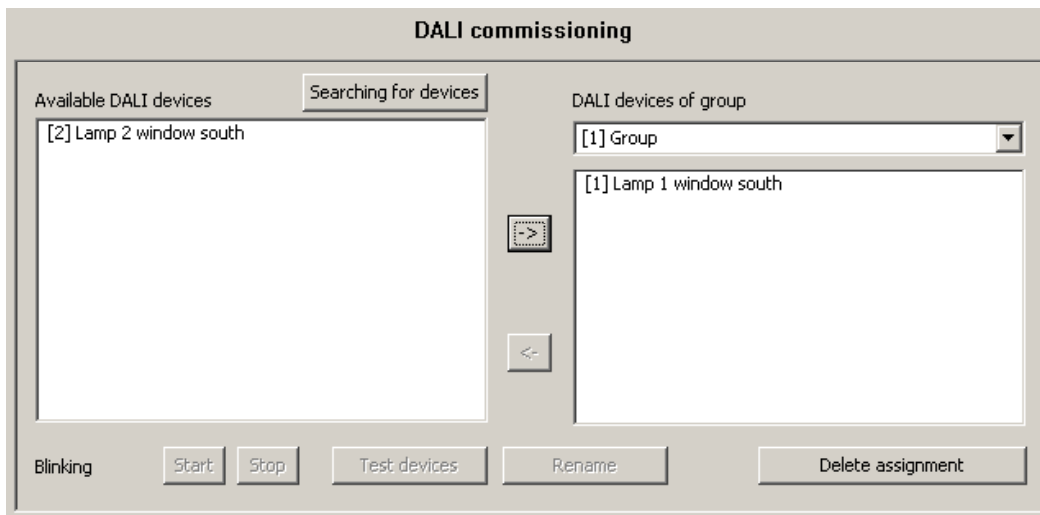

Figure 43: Assigning a device to a group

- If applicable, select another group from the right subwindow.
All available devices will again become visible in the left subwindow if no assignment has yet been made for the selected group.
 - Again, assign one or several available DALI devices to the group.
The assigned devices will be removed from the list box in the left subwindow and will appear for the selected group in the right window.
In case a device that has already been assigned is to be assigned to another group, the plug-in will report that the device has already been assigned to another group so that feedbacks of switching states and brightness values may no longer be distinct. After the message has been confirmed, the plug-in will make an assignment overlapping the groups. Devices that are assigned to several groups will be identified in the right subwindow by a "**".
In this case, the check box " Hide already assigned DALI devices " is disabled and can only be selected in the further course of the DALI commissioning if all multiple assignments of DALI devices to groups have been cancelled.
 - If applicable, proceed with group assignments as described.
- i** In case of the application program of version "0.4" or "1.4", it is possible to select the previously deleted check box " Hide already assigned DALI devices " anytime during the commissioning unless there have been assignments of DALI devices to several groups. Selecting the check box will then prevent a multiple assignment of DALI devices.

- ❗ Several devices can be assigned to the groups 1...16. Only one device can be assigned to each of the groups 17...32.
- ❗ DALI devices that are assigned several groups will always adjust to the state adjusted last via one of the assigned groups. In this case, the switching status or the brightness value feedback of a group is not necessarily unique.
Example 1: Group 2 is set to 10% brightness. Group 3 is then dimmed to a brightness value of 20%. The lamps of group 3 will accept the brightness value of 20% that was called up last. The feedback of group 2 remains on 10%, although some of the devices that belong to the group have been set to 20% brightness.
Example 2: group 2 is switched on and assumes the brightness value of 100%. The status of group 3 remains at 0% brightness (OFF) internally in the DALI Gateway. The brightness of group 3 has now been increased. The lamps of group 3 will adjust to the dimming (increasing brightness starting at minimum brightness) even though these lamps had been switched on before via group 2.
Basically, the assignment of DALI devices to groups is arbitrary. For the reasons mentioned above it is recommended not to assign the devices to several groups at the DALI. Preferably, the devices should be allocated to separate instead of overlapping groups. A KNX/EIB link via the group addressing in the ETS is also preferred.
- ❗ In the plug-in each group can be separately parameterized. During the programming with the ETS, the individual DALI devices will be programmed with the parameter data of the assigned groups. All devices assigned to a DALI group will be put into operation in the exact same way.
If, however, DALI devices have been assigned to several groups these devices will receive the project design with the highest group number.
- ❗ By activating the "Delete assignment" button in the lower margin of the commissioning environment all assignments between the DALI devices and the different groups can be deleted. However, not only the assignments will be reset in the plug-in but the commissioning parameters of the DALI Gateway will also be adjusted. The plug-in will establish a communication to the Gateway via the bus connection of the ETS 3 and delete all assignment in the device memory. This may take some time. The progress is shown during the deleting. In case of a faulty bus communication the plug-in will abort the operation without deleting any assignments in the project design or in the device. DALI devices previously identified are not deleted but will have no group assignments.
- ❗ The "Default" button will reset all commissioning parameters. Assignments of DALI devices to groups get lost from the project design and the DALI Gateway if the "Default" button in the commissioning environment has been activated!

Completing the DALI commissioning

Once the required DALI devices have been assigned to the groups in the plug-in, the commissioning can be completed. The commissioning parameters will be automatically transferred into the DALI Gateway after completion. For this reason the plug-in will communicate with the DALI Gateway via the ETS 3 bus connection.

The DALI Gateway must be connected to the KNX/EIB and the bus; the mains voltage must be switched on.

The ETS 3 must have a working communication interface to the bus (e.g. RS-232 or USB).

- The commissioning environment of the plug-in must be quit before the commissioning parameters are transferred into the DALI Gateway and into the devices. Select a different parameter page in the tree node view of the plug-in or close the plug-in by activating the "OK" button.

The synchronisation for the commissioning will now be executed. The process may take some time and depends on the number of the created groups and the connected DALI devices. The plug-in will program the Gateway with the group assignments first. A progress bar indicates the current progress (cf. figure 44).

Once the group assignments have been updated in the DALI Gateway, the connected DALI devices can now be updated as well. The Gateway communicates with the connected devices via the DALI line programming them automatically (cf. figure 45 on the following page).

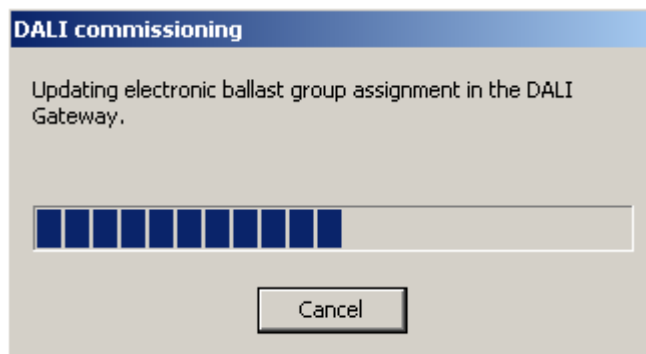

Figure 44: Synchronising the commissioning parameters between plug-in and DALI Gateway

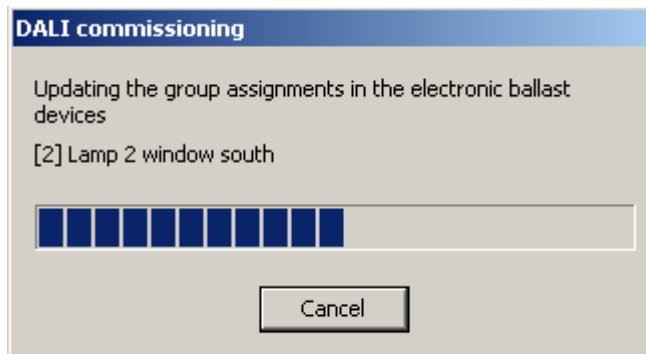

Figure 45: Synchronising the commissioning parameters between plug-in and DALI device

- Close the plug-in in order to complete the commissioning and to accept all required parameter settings. Then re-program the application program of the DALI Gateway with the ETS 3 (cf. Chapter 2.4 “Commissioning”).
- ❗ During the synchronisation of the commissioning parameters between plug-in and DALI device the Gateway verifies the operability of the DALI line. In case no communication can be established, the plug-in will abort the incomplete process displaying an error message. In this case the error located in the DALI line must be eliminated, the commissioning environment of the plug-in must be re-opened and closed in order to proceed with the synchronisation for the commissioning.
- ❗ When closing the commissioning environment the commissioning parameters (identified devices with short address, names of the devices, group assignment) will be written and stored into the ETS database. The stored data will be displayed the next time the commissioning environment is started.
- ❗ By activating the “Delete assignment” button in the lower margin of the commissioning environment, all assignments between the DALI devices and the different groups can be deleted. However, not only the assignments will be reset in the plug-in but the commissioning parameters of the DALI Gateway will also be synchronised. The plug-in will establish a communication to the Gateway via the bus connection of the ETS 3 and delete all assignments in the device memory. This may take some time. The progress is shown during the deleting. In case of a faulty bus communication the plug-in will abort the operation without deleting any assignments in the project design or in the device.
DALI devices previously identified are not deleted but will have no group assignments.

4.2.4.7 DALI test

Starting the DALI test

The plug-in of the DALI Gateway provides several options for a complete and comprehensive test of the DALI installation. It is possible to address and to switch individual devices during the device-oriented DALI test after a DALI commissioning and to read-out or preset brightness values. The status of the individual device can also be displayed.

During the group-oriented test all created DALI groups (1...32) can be separately switched or their brightness value can be separately changed (absolute brightness set point or relative dimming). It is also possible to check for the functioning of the configured scenes (1...16).

The DALI test can only be executed if the group and scene assignments in the addressed DALI Gateway is current after a DALI commissioning or after a new parameterization of group parameters. Thus, it is necessary to program the DALI Gateway with the ETS 3 prior to a DALI test in case there have been any changes to the device configuration (cf. Chapter 2.4 "Commissioning" and 4.2.4.5 "DALI commissioning").

Once all the requirements have been met, the "DALI test" on the parameter page of the plug-in with the same name can be executed. The commissioning environment becomes visible in the right subwindow of the plug-in after opening the test page and a successfully established communication with the DALI Gateway (cf. figure 46).

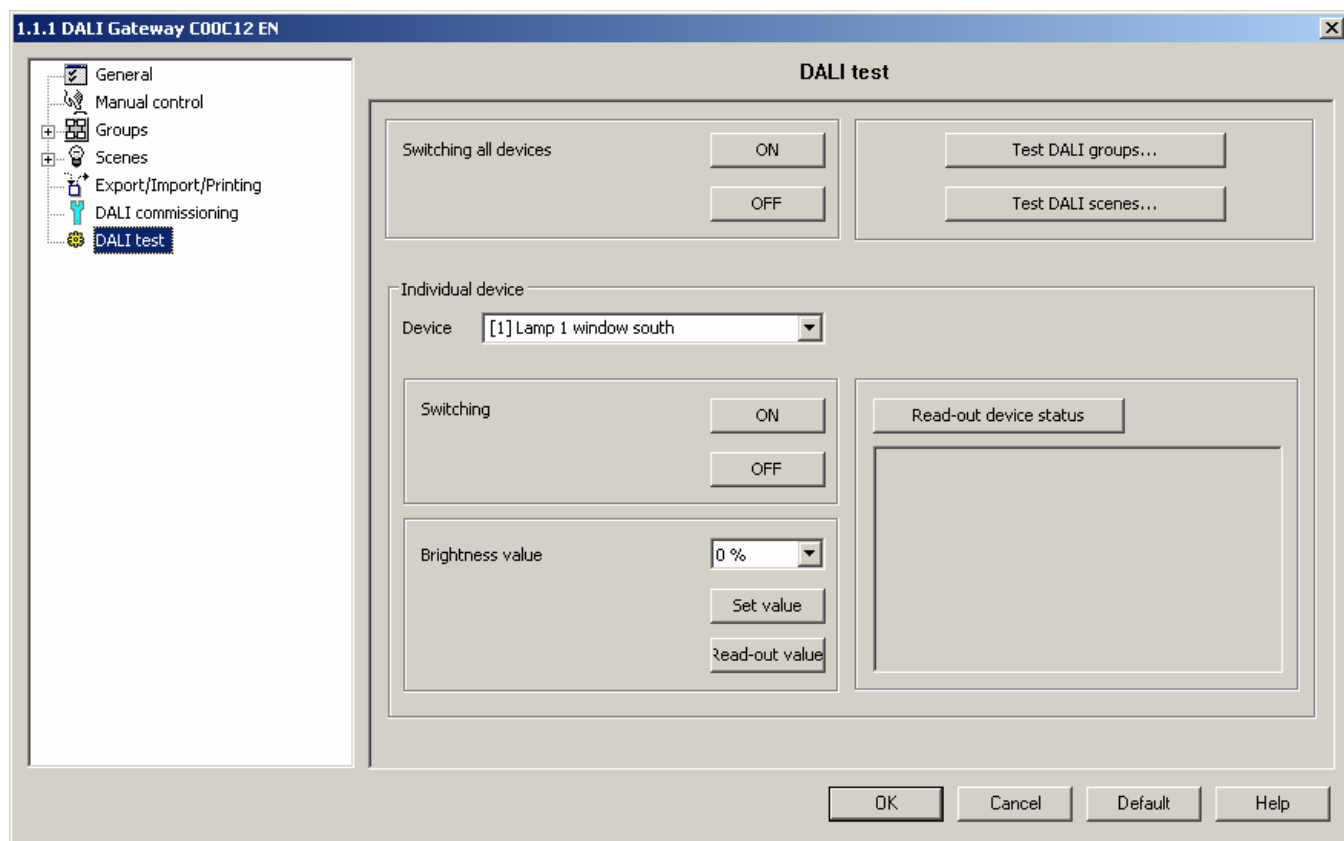

Figure 46: DALI test environment in the ETS 3 plug-in

When opening the test environment the plug-in first attempts to communicate with the DALI Gateway via the bus connection of the ETS and verifies whether a DALI test is possible. For this reason the DALI Gateway must be connected to the KNX/EIB and the bus and the mains voltage supply must be switched on if the DALI test is to be called up. In addition, the ETS 3 must have a working communication interface to the bus (e.g. RS-232 or USB).

In case a connection to the DALI Gateway cannot be established in this situation, the plug-in will abort the test prematurely and will not show the test environment. The following lists the possible reasons for a faulty connection and their corresponding remedies...

- Cause: no functioning ETS 3 communication interface to the KNX/EIB.
Remedy: verify the connection in the ETS 3 under "Tools – Options – Communication" . If needed, set up the connection.
- Cause: the physical address and the application program have not been programmed via the ETS 3.
Remedy: close the plug-in and program the physical address and the application program first.
- Cause: KNX/EIB bus voltage at the DALI Gateway or at the local data interface is not connected or switched on.
Remedy: connect and switch on bus voltage.
- Cause: mains voltage supply on the DALI Gateway is not switched on.
Remedy: switch on the mains voltage supply on the Gateway.

Device-oriented DALI test

Once a DALI commissioning has been executed and the devices have been identified, these devices can be checked for their proper functioning with the device-oriented DALI test. This can be done in the device-oriented test environment (cf. figure 47).

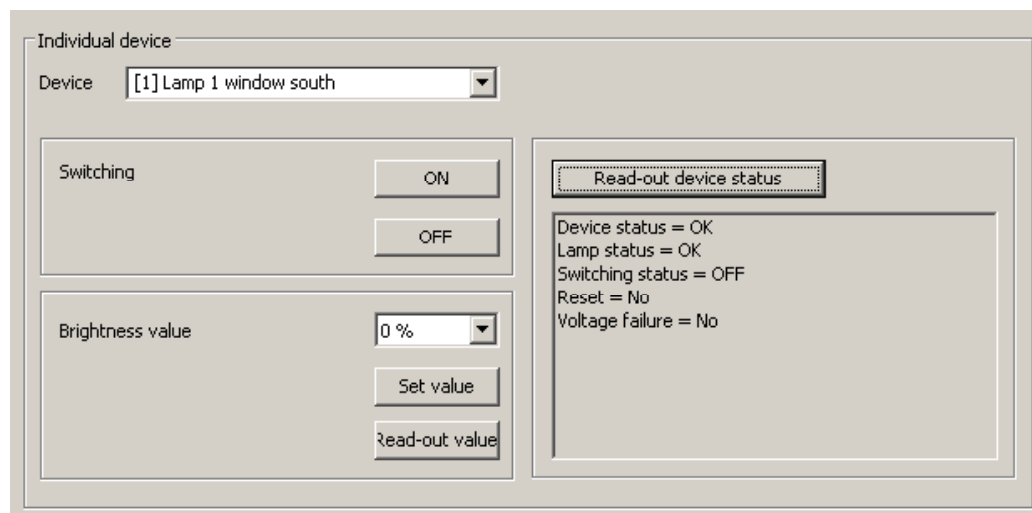

Figure 47: Device-oriented DALI test environment

The device to be tested must first be selected in the "Device" drop-down menu. The drop-down menu lists all identified DALI devices – identified in square brackets by the individual short address and the device name. Only one device at a time can be tested.

The selected device can then independently be switched on or switched off. In addition, it is possible to preset an absolute brightness value. When activating the "Set value" button the brightness value selected in the drop-down menu will be transmitted to the applicable device which should immediately accept this brightness value. The brightness value that can be set does not depend on the group parameterization for minimum or maximum brightness. Hence, the entire brightness range is available for the device-oriented test.

In the same way, the brightness value of the DALI device currently set can be requested by activating the "Read-out value" button. The read-out value will be displayed in the drop-down menu above.

By activating the "Read-out device status" it is possible to have the internal device states displayed. This permits to read-out and display the general device status (device error, e.g. internal electronic ballast error), the lamp status (e.g. defect lamps, cable break to the lamp socket), the current switching status, the reset status and the status of the mains voltage supply of the device.

The status information of a reset or a mains voltage failure depends on the DALI device in use. Not all devices will track these states.

- ❗ The Gateway can detect an error in the DALI line (e.g. short-circuit or interrupted line) during the device-oriented test only if information is to be read-out by the devices (read-out of value or device status). The plug-in will then report an error.
- ❗ The commands during the device-oriented DALI test will be forwarded to the devices directly via the DALI line. Group assignments will be ignored so that group objects during the test are not tracked preventing differences between the objects and the actual states of the devices incorporated in the groups.

DALI test affecting several devices

Once a DALI commissioning has been executed and the devices have been identified, these devices can be tested for their proper functioning with the DALI test. For that purpose the devices can be switched on or off altogether via a broadcast switching command (cf. figure 48).

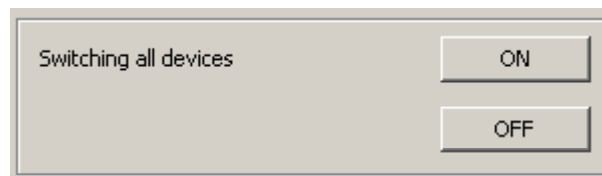

Figure 48: DALI test environment for a test affecting several devices

- ❗ A DALI test affecting several devices cannot detect an error in the DALI line (e.g. short-circuit or interrupted line).
- ❗ The commands during this test will be directly forwarded to the devices via the DALI line. Group assignments will be ignored so that group objects during the test are not tracked preventing differences between the objects and the actual states of the devices incorporated into the groups.

Group-oriented DALI test

The group-oriented DALI test can be executed once the groups have been created and parameterized in the device configuration and once the DALI commissioning including group assignments of the devices has been completed. Activate the "Test DALI groups" button in the DALI test environment. The group-oriented test environment will then open (cf. figure 49).

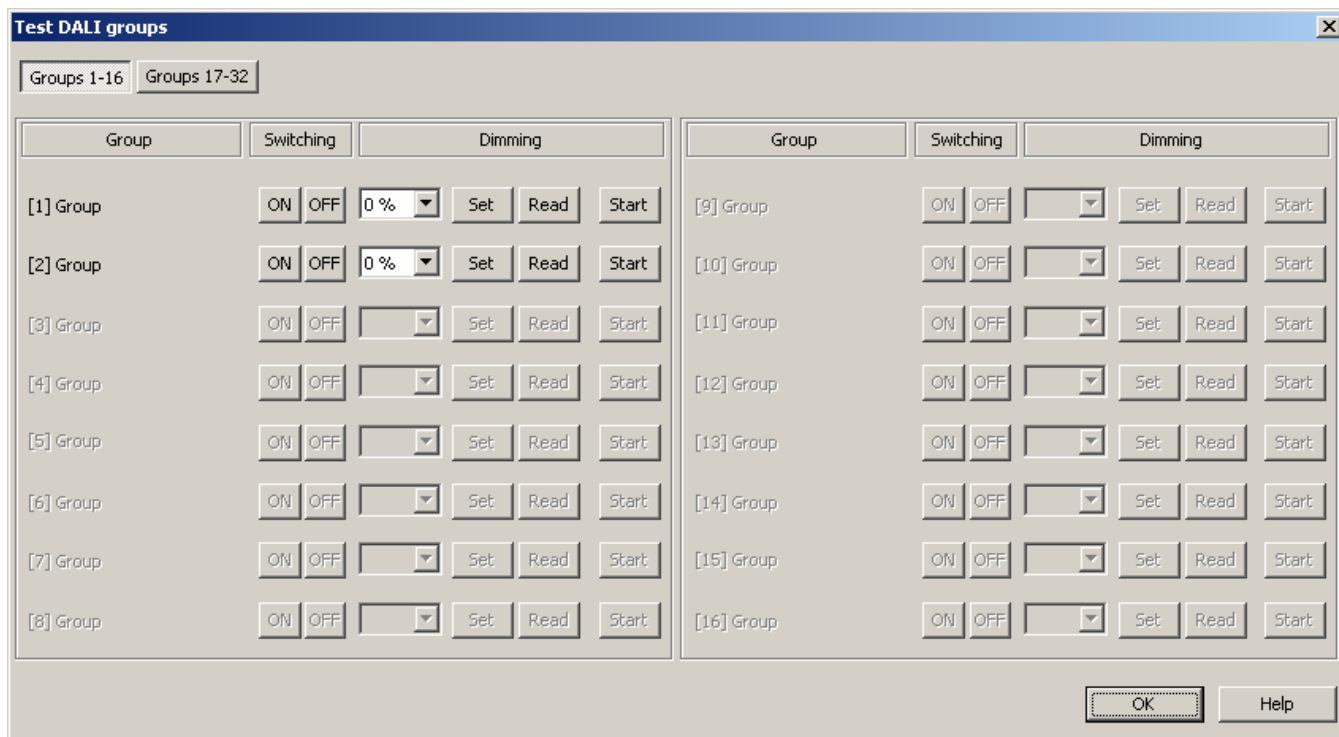

Figure 49: Group-oriented DALI test environment (in this example with two created groups)

For better clarity the available groups (1...32) are divided into two pages which can be shown separately. The page views can be switched by clicking on the "Groups 1-16" and "Groups 17...32" in the top margin of the page. Only those groups that have been created in the device configuration can be edited and thus tested. Groups not created are masked in grey.

During the group-oriented DALI test each group can be independently switched on or off and dimmed (relative or absolute dimming).

Activating the "ON" or "OFF" button will immediately cause the switching of the devices that have been assigned to the corresponding group.

Alternatively, an absolute brightness value can be specified that can be transmitted to the devices of the group by activating the "Set" button. The brightness value that can be set depends on the group parameterization for minimum or maximum brightness. If applicable, only a restricted brightness range can be adjusted during the group-oriented DALI test.

In the same way the brightness value of the DALI device currently set can be requested by activating the "Read" button. The read-out value will be displayed in the drop-down menu found next to it. The displayed value might slightly deviate from the one specified last as the value is rounded.

In addition, the devices of the group can be dimmed by a relative dimming operation. A relative dimming operation is initiated by activating the "Start" button. Starting at the current brightness value the dimming proceeds with the parameterized dimming speed within the brightness range specified for the group. A relative dimming operation can be stopped by activating the "Stop" button. If the "Start" button is activated again, dimming will take place in the opposite direction. A relative dimming to 0 % brightness (OFF) is not possible.

- ❗ A group-oriented DALI test can not detect an error in the DALI line (e.g. short-circuit or interrupted line).
- ❗ All actions during the group-oriented DALI test will be implemented internally via the corresponding KNX/EIB objects of the groups. The internal object values, for example, will be read-out during the readout of the brightness values. When a group is activated the switching object will be written. Feedback will also be created for the KNX/EIB and the corresponding DALI group parameters will be included. If no device has been assigned to the groups during the DALI commissioning there will be no reaction in the DALI system.
- ❗ DALI devices that are assigned several groups will always adjust to the state set last via one of the assigned groups. In this case, the feedback of the switching status or the brightness value of a group is not always unique.
Example 1: Group 2 is set to 10% brightness. Group 3 is then dimmed to a brightness value of 20%. The lamps of group 3 will accept the brightness value of 20% that was called up last. The feedback of group 2 remains on 10%, although some of the devices that belong to the group have been set to 20% brightness.
Example 2: group 2 is switched on and assumes the brightness value of 100%. The status of group 3 remains at 0% brightness (OFF) internally in the DALI Gateway. The brightness of group 3 has now been increased. The lamps of group 3 will adjust to the dimming (increasing brightness starting at minimum brightness) even though these lamps have been switched on before via group 2.

Scene-oriented DALI test

The scene-oriented DALI test can be executed once the groups have been created and parameterized in the device configuration and once the DALI commissioning including group assignments of the devices has been completed. Activate the "Test DALI scenes" button in the DALI test environment. The scene-oriented test environment will then open (cf. figure 50). Not only the groups embedded in the scenes can be tested during the scene test. So it is also possible to define a scene by reading-out and storing scene values.

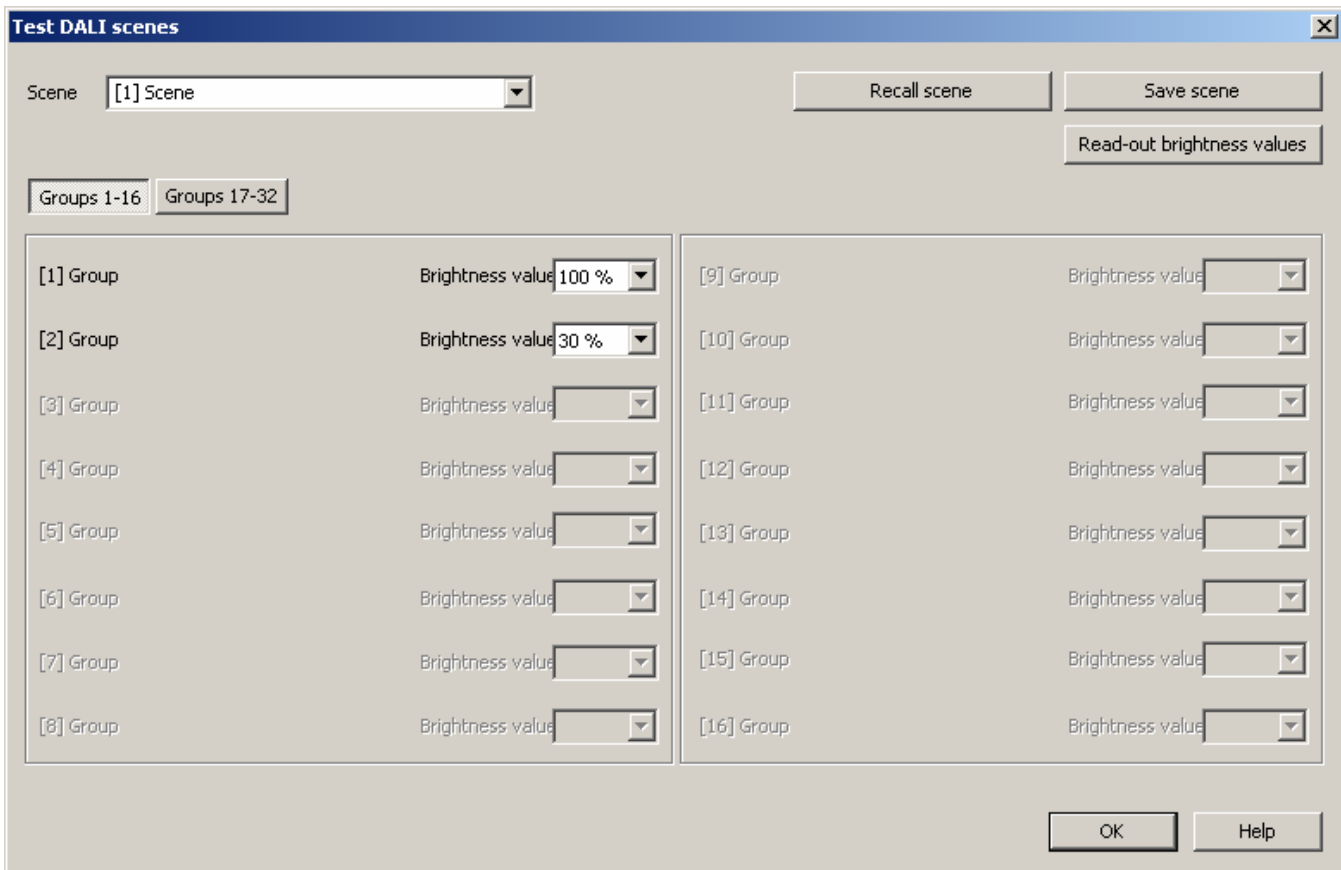

Figure 50: Scene-oriented DALI test environment (in this example with two created groups)

First, the scene to be tested has to be selected. For this purpose, one of the scenes created in the device configuration must be selected in the "Scene" drop-down menu. After the selection the assigned groups become visible and can be edited.

For better clarity the available groups (1...32) are divided into two pages that can be shown separately. The page views can be switched by clicking on the "Groups 1-16" and "Groups 17-32" in the top margin of the window. Only those groups that have been assigned a scene can be edited and thus tested. All groups not assigned are masked in grey.

The brightness values pre-defined in the scene configuration (parameter page "Scene") become visible in the corresponding drop-down menus of the groups when the scene-oriented DALI tests are started.

By activating the "Recall scene" button, a scene will be recalled with the brightness values that have been pre-defined during the scene configuration. The preset brightness values shown in the group drop-down menus of the test environment have no significance.

The brightness values for each group specified in the test environment will be accepted and stored in the scene configuration of the plug-in and the DALI Gateway only after the "Save scene" button has been activated. Thus, the brightness values originally pre-defined in the scene configuration will be overwritten.

It is possible to have the values currently set in the groups read-out before new brightness values for a scene are saved. The read-out brightness values will be displayed in the drop-down menus of the groups and can be edited at a later time and subsequently be saved for the scene.

- ❗ A scene-oriented DALI test cannot detect an error in the DALI line (e.g. short-circuit or interrupted line).
- ❗ All actions during the scene-oriented DALI test will be implemented internally via the corresponding KNX/EIB objects of the groups. For example, the internal object values will be read-out during the read-out of the brightness values. Also, feedback will be transmitted to the KNX/EIB during a scene recall. If no device has been assigned to the groups during the DALI commissioning there will be no reaction in the DALI system.
- ❗ If a DALI device has been assigned several groups and if these groups have been assigned to a scene, the brightness values of the groups with the highest group number will be recalled or saved for the multiple assigned devices. In this case, the feedback of the switching status or the brightness value of a group is not always unique.

4.2.4.8 Delivery state

In the delivery state the device behaves passively, i.e. no telegrams will be transmitted to the bus. A collective control of the connected DALI devices via the manual control broadcast on the device is possible if connected to the mains voltage. There will be no feedback to the bus during manual control. Other functions of the Gateway are deactivated.

The device can be programmed and put into operation via the ETS (only if the mains voltage is switched on). The physical address is preset to 15.15.255.



Upon delivery the following properties have been configured...

- Manual control: Broadcast
- Dimming speed manual control (0 %...100 %): 3.5 s
- Minimum brightness: 0,1 %
- Maximum brightness: 100 %
- Response to bus voltage failure: No response.
- Setting the response to bus voltage return: No response.
- Response to the mains voltage return at the DALI Gateway: No response by the DALI Gateway.
(Normally, the DALI devices initialize upon return of mains voltage to the "PowerOnLevel" that was programmed last.)

 The delivery state can be re-established any time by unloading the application program with the ETS.

4.2.5 Parameters

Description:	Values:	Remarks:
<input checked="" type="checkbox"/> General		
DALI error status feedback ?	Yes, feedback object is active message object Yes, feedback object is passive status object No	The error status of the DALI devices can be reported to the bus. Setting "Yes" activates the reporting function and enables the corresponding object. Moreover, the parameter defines whether the feedback telegrams are transmitted actively (telegram transmission in case of changes) or passively (telegram transmission only as a response to a Read request). The communication flags of the object are automatically set by the ETS according to the setting.
DALI Gateway mains voltage failure/return feedback ?	Yes (in case of voltage failure and return) Yes (only in case of voltage failure) No	The DALI Gateway is able to monitor its supply voltage (mains voltage connection) and can transmit a message telegram to the bus in case of failure even before shutting down. Setting "yes" activates the reporting function and enables the corresponding object. Moreover, it determines whether the message is to be transmitted only in case of supply voltage failure or also in case of supply voltage return.
DALI short-circuit feedback ?	Yes No	The DALI Gateway can transmit a message telegram to the bus if it detects a short-circuit in the DALI line. The "yes" setting activates the reporting function and enables the corresponding object. Alternatively, the "no" setting deactivates the short-circuit message.
		<p>i The "DALI short-circuit" or "DALI voltage failure" messages will only be triggered if the corresponding event has taking place and in case the mains voltage for the DALI Gateway is active.</p> <p>i The "DALI error status", "DALI short-circuit" or "DALI voltage failure" messages will not automatically be transmitted to the bus after the return of bus voltage with bus voltage applied at the DALI Gateway.</p>

Enable DALI device replacement manually ?	Yes No	After the start of the automatic device replacement, the DALI Gateway can check the DALI system via manual control for the integrity of the DALI devices incorporated in the system. Thus, the DALI Gateway is able to detect, for example, replaced electronic ballast devices and to program them with the appropriate project data. The automatic device replacement can be initiated locally via manual control (press the  and ALL OFF key simultaneously at least for 10 s) only if this parameter has been set to „Yes“. If set to “No” a manual operation will show no response.
Blinking rate	1 s 2 s 5 s 10 s	At the beginning and at the end of a disable function, if used, groups can also be parameterized to "blinking". In this case the corresponding devices of the groups will periodically change their switching status. The "Blinking rate" parameter generally defines the ON-time and the OFF-time of a "blinking" signal for all groups. Example: Blinking rate = 1 s 1 s on → 1 s off → 1 s on → 1 s off ...
Central function ?	Yes No	The "Yes" setting enables the central function and thus the "Central function" object. An assignment of individual DALI groups to the central function is possible only if the function is enabled.
Central object polarity	0 = deactivated / 1 = activated 1 = deactivated / 0 = activated	This parameter determines the polarity of the central object.  This parameter becomes visible only if the central function is enabled.

Manual control

Manual control in case of bus voltage failure	Disabled Enabled	In case of a bus voltage failure (bus voltage switched off) you can determine whether manual control is to be enabled or disabled.
Manual control during bus mode	Disabled Enabled	For the bus mode (bus voltage switched on) you can determine whether manual control is to be enabled or disabled.
Disable function for manual control ?	Yes No	The manual control can be disabled via the bus even with the manual control mode activated. For this purpose the disable object can be enabled at this point.
Polarity of disable object for manual control	0 = enabled / 1 = disabled 1 = enabled / 0 = disabled	This parameter determines the polarity of the disable object. ⓘ Visible only in case of enabled disable function for manual control. ⓘ After a bus/ mains voltage return or after programming with the ETS, the disable function will be immediately active (object value "0") in case of the setting: "1 = enabled / 0 = disabled".
Transmit manual control status ?	Yes No	The current status of the manual control can be transmitted to the bus via a separate status object if bus voltage is active (setting: "yes").

Function and polarity of status object

0 = inactive; 1 = manual control is active

0 = inactive; 1 = permanent manual control is active

This parameter specifies the information contained in the status object. The object will always be "0" if the manual control has been deactivated.

The object will be "1" if the manual control has been activated (temporarily or permanently).

The object will be "1" only if the permanent manual control has been activated.

i This parameter is visible only if the transmission of the manual control status has been enabled.

i After bus voltage return, the status will be actively transmitted to the bus ("0") only if a manual control that was activated during bus voltage failure has been terminated by the return of the bus voltage. The status telegram will be transmitted without delay.

Behaviour at the end of permanent manual control during bus mode

No change

Track outputs

The behaviour of the Gateway at the end of the permanent manual control depends on this parameter.

All telegrams received during an active permanent manual control for direct control (switching, dimming, brightness value, scenes) will be discarded. After the end of the permanent manual control, the current status of all groups remains unchanged. If, however, a forced-control position or a disable function has been activated before or during manual control, the Gateway will set the response parameterized for this function for the relevant groups.

During an active permanent manual control all incoming telegrams are internally tracked. At the end of the manual control the groups will be set according to the command received last or to the status that existed prior to the manual control.

Bus mode of individual groups can be disabled

Yes

No

Individual groups can be locally disabled during a permanent manual control so that the disabled groups can no longer be addressed via the bus. A disable via manual control will only be permitted if this parameter has been set to "yes".

Groups

<p>Time for the cyclical transmission of the feedback telegram</p>	<p>00:00:10 ... 23:59:59 [hh:mm:ss] 20 s</p>	<p>Depending on the parameterization, all active feedback telegrams of the Gateway can transmit their status also cyclically to the bus. The "Time for cyclical transmission of feedback telegram" parameter generally defines the cycle time for all groups.</p> <p><i>Presetting: 20 seconds</i></p>
<p>Time delay for feedback telegram after bus voltage return</p>	<p>00:00 ... 59:59 [mm:ss] 5 s</p>	<p>To reduce telegram traffic on the bus line after bus voltage activation (bus reset) or mains supply activation, after connection of the device to the bus line or after programming with the ETS, it is possible to delay all active feedback telegrams of the Gateway. In this case the parameter specifies a delay time for all devices. Feedback telegrams for bus initialization will be transmitted to the bus only after the time parameterized at this point has elapsed.</p> <p><i>Presetting: 5 seconds</i></p> <p> The "DALI error status", "DALI short-circuit" or "DALI voltage failure" messages will basically be transmitted without any time delay.</p>

 [x] Group (x = 1 ... 32) The name of the group can be edited and will be displayed in the node..

Name	0 ... 28 characters Group	<p>The group can be assigned a unique name (e.g. "Office window side 1". The project name will be displayed in the group view in the left plug-in window.</p> <p>The name serves as a better orientation in the plug-in. The name will not be programmed into the device.</p>
Minimum brightness	0,1 % 0,2 % 0,5 % 1 % 3 % 5 % 10 % 15 % 20 % 25 % 30 % 35 % 40 % 45 % 50 % 55 % 60 % 65 % 70 %	<p>This parameter will set the minimum brightness of the DALI group will be set. The parameterized value will not be under-run regardless of the operating state of the Gateway.</p> <p>i The value to be set at this point cannot exceed the parameterized maximum brightness (minimum brightness < maximum brightness).</p> <p>i During the editing of the minimum brightness the ETS plug-in will check all parameterized brightness values of the group (e.g. switch-on brightness, scene values etc.) to see whether the values will fall below the minimum brightness. In that case, the plug-in will report a conflict of values and offers the following option...</p> <ul style="list-style-type: none"> – the brightness values can be adjusted to the minimum brightness or – the setting of the minimum brightness will be reset to the original value. <p>i In case values are received via the brightness value object that fall short of the parameterized minimum brightness, the Gateway will set the minimum brightness as the new brightness value for the affected group.</p>

Maximum brightness	30 %	<p>This parameter will set the maximum brightness of the DALI group will be set. The parameterized value will not be exceeded regardless of the operating state of the Gateway.</p> <p>i The value to be set at this point cannot fall below the parameterized minimum brightness (minimum brightness < maximum brightness).</p> <p>i During the editing of the maximum brightness the ETS plug-in will check all parameterized brightness values of the group (e.g. switch-on brightness, scene values etc.) to see whether the values will exceed the maximum brightness. If this is the case, the plug-in will report a conflict of values and offers the following option...</p> <ul style="list-style-type: none">– the brightness values can be adjusted to the maximum brightness or– the setting of the maximum brightness will be reset to the original value. <p>i In case values that are received via the brightness value object exceed the parameterized maximum brightness, the Gateway will set the maximum brightness as the new brightness value for the affected group.</p>
	35 %	
	40 %	
	45 %	
	50 %	
	55 %	
	60 %	
	65 %	
	70 %	
	75 %	
	80 %	
	85 %	
	90 %	
	95 %	
100 %		

Switch-on brightness

This parameter determines the brightness value that the group is adjusted to each time there is a switch-on via the "Switching" or "Switching central function" object.

Brightness value

When switching on, the group will be adjusted to the brightness value specified in the drop-down menu next to the parameter. The adjustable value must be within the limits of the parameterized maximum and minimum brightness.

Memory value (brightness prior to the last shut-off)

When switching on, the brightness value equals the one that was active and internally stored prior to the switch-off (via the "Switching" or "Switching central function"). This memory value non-permanently stored so that the value is pre-defined to the maximum brightness after the return of bus or mains voltage or after programming with the ETS.

i If the no Soft-on function is activated, the brightness value will be activated when switching on.

Behaviour after ETS programming

The Gateway permits to separately set the brightness value for each group after programming with the ETS.

Switch-off

The group will be switched off.

Brightness value

The group will be adjusted to the brightness value specified in the drop-down menu next to the parameter. The adjustable value is restricted by the parameterized minimum and maximum brightness.

No change

After the ETS programming, the DALI devices of a group will show not response and keep the current brightness value or remain switched off.

i The parameterized behaviour will be executed after every application or parameter download by the ETS. A simple download of the physical address alone or partial programming of only the group addresses has the effect that this parameter is disregarded and that the parameterized "Response to bus voltage return" will be executed

Response to bus voltage
failure

The Gateway permits to set separately the brightness value for each DALI group after a bus voltage failure.

Switch-off

The group will be switched off.

Brightness value

The group will be adjusted to the brightness value specified in the drop-down menu next to the parameter. The adjustable value is restricted by the parameterized minimum and maximum brightness.

No change

Following a bus voltage failure, the DALI devices of a group will not react and keep the current brightness value or remain switched off.

Response to bus voltage return		<p>The Gateway permits to separately set the brightness value for each DALI group after bus or mains voltage return separately.</p> <p>The group will be switched off.</p>
	Switch-off	
	Brightness value	<p>The group will be adjusted to the brightness value specified in the drop-down menu next to the parameter. The adjustable value is restricted by the parameterized minimum and maximum brightness.</p>
	Brightness value as prior to bus voltage failure	<p>After bus/ mains voltage return, the brightness value that was internally stored last <u>prior</u> to the bus/ mains voltage failure will be tracked.</p>
	No change	<p>Following a bus/ mains voltage failure, the DALI devices of a group will show no response and keep the current brightness value or remain switched off.</p>
	Start Staircase timer function	<p>Independent of the "Switching" object, the Staircase timer function will be activated after bus/ mains voltage return. Make sure that the Staircase timer function has been enabled. In case the Staircase timer function has not been enabled, this setting will produce no reaction after the return of bus/ mains voltage.</p> <p>i Setting "Brightness value as prior to bus voltage failure": When programming the application or the parameters with the ETS, the internally stored switching state will be reset to "Off – 0".</p> <p>i The parameterized response will always be executed after bus/ mains voltage return. It must be pointed out that after a bus/ mains voltage return a forced-control position might also be activated which, if applicable, can affect the brightness status of the group.</p>
Type of additional function	No additional function	
	Disable function	
	Forced-control position function	<p>This parameter can be used to define and to enable the additional function. The disable function can only be parameterized as an alternative to the forced-control position function.</p>

Polarity of disable object **0 = enabled / 1 = disabled**

1 = enabled / 0 = disabled

This parameter defines the polarity of the disable object.

i The disable function will always be deactivated (object value "0") after a bus or mains voltage return or after programming the application with the ETS. In the inverted setting ("1 = enabled; 0 = disabled"), a "0" telegram update must first be transmitted after the initialization before the disabled status will be activated.

i This parameter becomes visible only if the disable function is enabled.

Response at the beginning of the disable function

Switch-off

The behaviour of the DALI group at the beginning of the disable function can be parameterized.

At the beginning of the disable the group will be switched off and locked.

Blinking

During the disable the DALI devices will blink on and off while the bus mode of the group is locked. Generally, the blinking time for all groups is parameterized on the "General" parameter card. During blinking, the logic switching state is "ON - 1". The brightness reported back is the switch-on brightness. A Soft-ON/OFF function will be ignored during the blinking.

Brightness value

At the beginning of the disable, the group will be adjusted to the brightness value specified in the drop-down menu next to the parameter. The adjustable value is restricted by the parameterized minimum and maximum brightness.

No change

At the beginning of the disable, the DALI devices of a group will not react and keep the current brightness value or remain switched off. The bus mode of the group will be locked.

Memory value (brightness prior to the last shutoff)

At the beginning of the disable, the brightness value will be set to the value that was active and internally stored prior to the switch-off (via the "Switching" object). This memory value is permanently stored so that the value is pre-defined to the maximum brightness after the return of bus or mains voltage or after programming with the ETS. The bus mode of the group will be locked afterwards.

i An output disabled via the bus can still be manually controlled at the Gateway!

i This parameter becomes visible only if the disable function is enabled.

Response at the end of the disable function

The behaviour of the DALI group at the end of the disable function can be parameterized.

Switch-off

At the end of the disable the group will be switched off and re-enabled.

Blinking

After the end of the disable, the DALI devices of the group will be re-enabled for the bus mode blinking on and off. Generally, the blinking time is parameterized for all groups on the "General" parameter card. During blinking, the logic switching state is "ON - 1". The brightness reported back is the switch-on brightness. A Soft-ON/OFF function will be ignored during the blinking. The blinking status will remain active until another bus command is received or until the manual control will provide a different status.

Brightness value

At the end of the disable, the group will be adjusted to the brightness value specified in the drop-down menu next to the parameter. The adjustable value is restricted by the parameterized minimum and maximum brightness.

No change

At the end of the disable the DALI devices of a group will not react and keep the current brightness value or remain switched off. The bus mode of the group will be re-enabled afterwards.

 This parameter becomes visible only if the disable function is enabled.

Response at the end of the disable function (continued)	Memory value (brightness prior to the last shutoff)	At the end of the disable, the value will be adjusted to the brightness value that was active and internally stored prior to the last switch-off (via the "Switching" or "Switching central function" object). This memory value is non-permanently stored so that the value is pre-defined to the maximum brightness after the return of bus voltage or after programming with the ETS. The bus mode of the group will be re-enabled afterwards. Time functions will be included.
	Tracked brightness value	At the end of a disable, the status received or set prior to the executed disable function will be resumed with the applicable brightness value. If applicable, active time functions will also be considered. [i] This parameter becomes visible only if the disable function is enabled.

Response to bus voltage return

The communication object of the forced-control position function can be initialized after bus voltage return. The brightness status of the DALI group can be influenced if the forced-control position function is activated.

No forced-control position active

No forced-control position will be activated after bus voltage return.

Status as prior to bus voltage failure

The status of the forced-control position will be set to the status that was permanently stored at the time of bus voltage failure. After programming the application or the parameters with the ETS, the value is internally set to "not active". In case of an activated function the DALI devices of the group will be switched on to the brightness value provided by the "Brightness for forced-control position active, ON" parameter.

Forced-control position active, switching off

The forced-control position will be activated. The DALI devices of the group will be switched off by forced control.

Forced-control position active, switching on

The forced-control position will be activated. The DALI devices of the group will be switched on to the brightness value provided by the "Brightness for forced-control position active, ON" parameter.

i After programming the application or the parameters with the ETS, the forced-control position will always be deleted.

i This parameter becomes visible only if the forced-control position function has been enabled.

Brightness for forced-control position active, ON

If the forced-control position is active and a forced switching is "ON", the parameter will determine the behaviour of the Group's DALI devices.

Brightness value

The group will be adjusted to the brightness value specified in the drop-down menu next to the parameter. The adjustable value is restricted by the parameterized minimum and maximum brightness.

No change

The DALI devices of a group will not react and keep the current brightness value or remain switched off.

Memory value (brightness prior to the last shutoff)

The value will be adjusted to the brightness value that was active and internally stored prior to the last switch-off (via the "Switching" or "Switching central function" object). This memory value is permanently stored so that the value is pre-defined to the maximum brightness after the return of bus or mains voltage or after programming with the ETS.

i This parameter becomes visible only if the forced-control position function has been enabled.

Response at the end of the forced-control position function

The response of the DALI group at the end of the forced-control position can be parameterized.

No change

At the end of the forced-control position, the DALI devices of a group will not react and keep the current brightness value or remain switched off. The bus mode of the group will be re-enabled afterwards.

Tracked brightness value

At the end of a forced control, the status received or set prior to the executed forced-control position function will be resumed with the applicable brightness value. If applicable, active time functions will also be considered. The bus mode of the group will be re-enabled afterwards.

i This parameter becomes visible only if the forced-control position function has been enabled.

Switching

Switching status feedback ?		The current switching state of the DALI group can be reported back separately to the bus.
	Yes, feedback object is active message object	Feedback and object are activated. The status is transmitted in non-inverted form. The object transmits actively (telegram transmission after change or, if applicable, in cycles).
	Yes, feedback object is passive status object	Feedback and object are activated. The status is transmitted in non-inverted form. The object is passive (telegram transmission only as a response to a read request).
	No	No feedback object available for the group. Feedback is deactivated. <input type="checkbox"/> The communication flags of the object are automatically set by the ETS plug-in according to the setting.
Time delay for feedback telegram after bus voltage return ?	Yes	The feedback telegram can be transmitted to the bus with a delay after bus voltage return or after programming with the ETS. The "Yes" setting activates the delay time of the feedback in case of bus voltage return. Generally, the delay time will be parameterized on the "group" parameter page. <input type="checkbox"/> This parameter becomes visible only in case of an actively transmitting feedback object.
	No	
Cyclical transmission of feedback telegram ?		The object value of the feedback can be transmitted cyclically.
	Yes (cyclical transmission and transmission in case of changes)	The feedback telegram is transmitted to the bus cyclically and after a change of status. Generally, the cycle time will be programmed on the "Groups" parameter card for all feedback telegrams.
	No (transmission only in case of changes)	The feedback telegram is transmitted to the bus only after the status has changed. <input type="checkbox"/> This parameter becomes visible only in case of an actively transmitting feedback object.

Assignment to central
function ?

Yes

This parameter determines the assignment
of the DALI group to the central function.

The group is assigned to the central
function.

No

The group is not assigned to the central
function.

 This parameter becomes visible only if
the central function is enabled.

Dimming

<p>Time for relative dimming (0...100%)</p>	<p>00:00:01 ... 05:59:59 [hh:mm:ss] 5 s</p>	<p>This parameter will set the relative time increments (4-bit dimming). The time entered defines the maximum duration for the dimming across the entire brightness range from 0 % to 100 % brightness.</p>
<p>Dimming response to a brightness value</p>	<p>Dim Jump to</p>	<p>This parameter determines whether a brightness value received via the bus (absolute dimming) will be instantly jumped to or whether light intensity will dim to the brightness.</p>
<p>Time for absolute dimming (0...100%)</p>	<p>00:00:01 ... 23:59:59 [hh:mm:ss] 5 s</p>	<p>This parameter will set the time for the increments increments (1-byte dimming). The time entered defines the maximum duration for the dimming across the entire brightness range from 0 % to 100 % brightness.</p> <p>i This parameter becomes visible only when set to: "Dimming response to a brightness value" = "Dim".</p>
<p>Automatic shutoff when falling below a specified brightness ?</p>	<p>Yes No</p>	<p>The automatic shutoff function for a group can be activated. If activated, the DALI devices of the group will shut off completely as soon as a parameterized brightness has been reached or under-run at the end of a dimming operation and, if applicable, after the delay time has lapsed.</p>
<p>Shutoff when brightness value smaller</p>	<p>0.1 % ... 100 %; 5 %</p>	<p>This parameter determines the brightness to be reached or under-run at the end of a dimming operation that will cause the group to be switched off, if applicable, after the delay time has lapsed.</p> <p>i The adjustable value is restricted by the parameterized minimum and maximum brightness. The standard setting will also adapt accordingly.</p> <p>i If the shutoff brightness has been under-run by a disable or forced-control position function or a staircase pre-warning function, the shutoff function will not be executed.</p> <p>i This parameter becomes visible only if the shutoff function has been enabled.</p>

Delay until shutoff ?	<p>Yes</p> <p>No</p>	<p>This parameter activates the delay time of the automatic shutoff function. After the delay time has lapsed the DALI group will shut off if the shut-off brightness has been reached or under-run at the end of a dimming operation.</p> <p>i This parameter becomes visible only if the shutoff function has been enabled.</p>
Delay time until shutoff	<p>00:01 ... 59:59 [mm:ss]</p> <p>30 s</p>	<p>This parameter will set the delay time for the shutoff function. After the time set at this point has lapsed the DALI group will be shut off if the shutoff brightness has been reached or under-run at the end of a dimming operation.</p> <p>i This parameter becomes visible only if the shutoff function has been activated and the delay time has been enabled.</p>
Brightness value feedback ?	<p>Yes, feedback object is active message object</p> <p>Yes, feedback object is passive status object</p> <p>No</p>	<p>The current brightness value of the DALI group can be reported back separately to the bus.</p> <p>Feedback and object is activated. The object transmits actively (telegram transmission after change or, if applicable, in cycles).</p> <p>Feedback and object is activated. The object is passive (telegram transmission only as a response to a read request).</p> <p>No feedback object available for the group. Feedback is deactivated.</p> <p>i The communication flags of the object are automatically set by the ETS plug-in according to the setting.</p>
Time delay for feedback telegram after bus voltage return ?	<p>Yes</p> <p>No</p>	<p>The feedback telegram can be transmitted to the bus with a delay after bus voltage return or after programming with the ETS. The "Yes" setting activates the delay time of the feedback in case of bus voltage return. Generally, the delay time will be parameterized on the "group" parameter card.</p> <p>i This parameter becomes visible only in case of an actively transmitting feedback object.</p>

Cyclical transmission of
feedback telegram ?

The object value of the feedback can be
transmitted in cycles.

Yes (cyclical transmission and
transmission in case of
changes)





The feedback telegram is transmitted to the
bus in cycles and after a change of status.
Generally, the cycle time will be
programmed on the "Groups" parameter
card for all feedback telegrams.

**No (transmission only in
case of changes)**

The feedback telegram is transmitted to the
bus only after the status has changed.

This parameter becomes visible only in
case of an actively transmitting feedback
object.

Switch-on/switch-off behaviour

Selection of time delay	<p>None</p> <p>ON-delay</p> <p>OFF-delay</p> <p>ON-delay and OFF-delay</p>	<p>The “Switching” and “Switching central function” communication objects can be separately evaluated. This parameter is used to define the desired mode of operation of the time delay and to enable the other delay parameters.</p>
ON-delay time	<p>00:00:01 ... 23:59:59 [hh:mm:ss]</p> <p>30 s</p>	<p>This parameter is used for programming the duration of the ON-delay</p> <p> This parameter becomes visible only if the On-delay or the On and OFF-delay has been activated.</p>
ON-delay retriggerable ?	<p>Yes</p> <p>No</p>	<p>An active ON-delay can be retriggered by another "1" telegram (setting "yes") Alternatively, retriggering can be suppressed (setting "No").</p> <p> This parameter becomes visible only if the On-delay or the On and OFF-delay has been activated.</p>
OFF-delay time	<p>00:00:01 ... 23:59:59 [hh:mm:ss]</p> <p>30 s</p>	<p>This parameter is used for programming the duration of the OFF-delay</p> <p> This parameter becomes visible only if the Off-delay or the On and OFF-delay has been activated.</p>
OFF-delay retriggerable ?	<p>Yes</p> <p>No</p>	<p>An active OFF-delay can be retriggered by another "0" telegram (setting "yes") Alternatively, retriggering can be suppressed (setting "No").</p> <p> This parameter becomes visible only if the Off-delay or the On and OFF-delay has been activated.</p>
Soft-ON function ?	<p>Yes</p> <p>No</p>	<p>The Soft-ON function permits a slowed-down switch-on of the DALI group. If the function is activated (setting “Yes”) a dimming operation is started until the switch-on brightness is reached on reception of a switch-on telegram via the “Switching” or “Switching central function” objects.</p>

Time for Soft-ON (0...100%)	00:00:01 ... 23:59:59 [hh:mm:ss] 5 s	This parameter determines the dimming increment time for the Soft-ON function. The time entered defines the maximum duration for the Soft-ON dimming across the entire brightness range from 0 % to 100 % brightness. ⓘ The Soft-ON time cannot be retriggered. ⓘ This parameter becomes visible only if the Soft-ON function is enabled.
Soft-OFF function ?	Yes No	The Soft-OFF function allows for a slowed-down switch-off of the DALI group. If the function is activated (setting "Yes") a dimming operation is started until the switch-on brightness is reached on reception of a switch-off telegram via the "Switching" or "Switching central function" objects.
Time for Soft-OFF (0...100%)	00:00:01 ... 23:59:59 [hh:mm:ss] 5 s	This parameter determines the dimming increment time for the Soft-OFF function. The time entered defines the maximum duration for the Soft-OFF dimming across the entire brightness range from 100 % to 0 % brightness. ⓘ The Soft-OFF time cannot be retriggered. ⓘ This parameter becomes visible only if the Soft-OFF function is enabled.



Staircase timer function (applies only to DALI groups 1...16!)

Staircase timer function ?	Yes	This parameter can enable the Staircase timer function and the corresponding communication objects.
	No	
Staircase lighting time	00:00:01 ... 23:59:59 [hh:mm:ss] 2 min	This parameter is used for programming the duration of the Staircase timer function. <input type="checkbox"/> This parameter will be visible only if the Staircase timer function has been enabled.
Staircase lighting time retriggerable ?	Yes	An active switch-on time can be retriggered (setting "Yes"). Alternatively, retriggering can be suppressed (setting "No"). <input type="checkbox"/> This parameter will be visible only if the Staircase timer function has been enabled.
	No	
Response to OFF telegram		An active switch-on time can be cancelled prematurely by switching off the Staircase timer function.
	Switch-off	The staircase lighting time is cancelled if an OFF-telegram to the "Staircase timer start / stop" object has been received.
	Ignore	OFF telegrams will be ignored. The switch-on time will be fully completed. <input type="checkbox"/> This parameter will be visible only if the Staircase timer function has been enabled.
Activate pre-warning time ?		Once the switch-on time of a Staircase timer function has ended, the DALI devices of the group are able to produce a pre-warning prior to the shutoff (brightness reduction). The pre-warning function is designed to warn anyone present in the staircase that the lights will go out shortly.
	Yes	The pre-warning function is activated.
	No	The pre-warning function is deactivated. <input type="checkbox"/> This parameter will be visible only if the Staircase timer function has been enabled.

Reduced brightness during pre-warning time	0.1 % ... 100 %; 10 %	<p>This parameter determines the reduced brightness to be adjusted at the time of the pre-warning.</p> <ul style="list-style-type: none"><input type="checkbox"/> The adjustable value is restricted by the parameterized minimum and maximum brightness. The standard setting will also adjust accordingly.<input type="checkbox"/> The reduced brightness will not start the shutoff function when it reaches or falls short of the specified shutoff brightness.<input type="checkbox"/> This parameter will be visible only if the Staircase timer function has been activated.
Pre-warning time	00:01 ... 59:59 [mm:ss] 30 s	<p>This parameter is used for programming the duration of the pre-warning time. The pre-warning time is added to the switch-on time. During the time parameterized at this point, the reduced brightness will be adjusted.</p> <ul style="list-style-type: none"><input type="checkbox"/> This parameter will be visible only if the Staircase timer function has been enabled and the pre-warning time has been activated.

Overwrite scene values during ETS download ?	No Yes	During storage of a scene, the scene values (current brightness values of the affected groups) are stored internally in the device. To prevent the stored values from being replaced during ETS programming by the originally programmed scene values, the Gateway can inhibit the overwriting of the scene values (setting: "No"). Alternatively, the original values can be reloaded into the device during each ETS programming (setting: "Yes").
Delay scene recall ?	Yes No	A scene is recalled via the scene extension object. If needed, the scene recall at the Gateway can be delayed after reception of a recall telegram (setting: "Yes"). Alternatively, the recall takes place immediately after the reception of the telegram (setting: "No"). i A recall delay has no influence on the storage of scene values.
Delay time	00:00:01 ... 05:59:59 [hh:mm:ss] 5 s	The parameter defines the delay time to be transmitted in case of a scene recall. i This parameter is visible only if the "Delay scene recall ?" parameter is set to "Yes".