

Product name: **One-channel universal dimming actuator FM**
 Design: FM (flush-mounted type)
 Article no.: **1058 00**
 ETS search path: Gira Giersiepen / illumination / dimmer / universal dimming actuator FM 210 W

Functional description

The universal dimming actuator works on the phase cut-on or cut-off principle and permits switching and dimming of incandescent lamps, HV halogen lamps and LV halogen lamps with conventional and electronic transformers. The device auto-detects the load characteristics of the connected consumer and selects the appropriate dimming principle.

In addition, the device is equipped with two extension inputs which - depending on parameterization - can act directly on the dimming output (local control of output via input 1) or alternatively as binary inputs on the KNX/EIB. The potential-free switch or push-button contacts are connected to a common reference potential at the universal dimming actuator. As a binary input, the device can transmit telegrams for switching or dimming, for blind/shutter control or for value transmitter applications (dimming value transmitter, light-scene extension). Connecting 230 V signals or other external voltages to the extension inputs is not permitted.

Illustration:

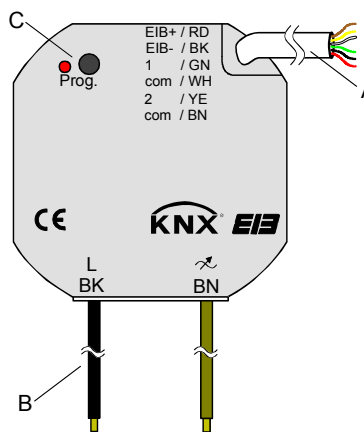

Dimensions:

Ø: 53 mm
 height (H): 28 mm

Controls:

A low-voltage connecting wire
 red: bus (+)
 black: Bus (-)
 green: extension input 1
 white: reference potential (com)
 yellow: extension input 2
 brown: reference potential (com)

B load connecting wires
 1 x black: L (phase conductor)
 1 x brown:  (dimming output)

C: programming button / LED (red)

Technical data

KNX/EIB supply	
Cable type:	YY 6 x 0.6 mm; red: bus (+) / black: bus (-)
Voltage:	21 – 32 V DC SELV
Power consumption:	typically 150 mW
Connection:	approx. 33 cm ready-made; connecting terminal (0.6 – 0.8 mm)
External supply	Connection to phase conductor (two-wire circuit)

instabus KNX/EIB System

Actuator



Input:

Number:	2	(depending on parameterization either as extension inputs for local control of the actuator or as independent binary inputs acting on the bus)
Cable type:	YY 6 x 0.6 mm	
	green:	extension input 1
	white:	common reference potential (com)
	yellow:	extension input 2
	brown:	common reference potential (com)
Cable length:	approx. 33 cm ready-made, extendible to 5 m max.	
Scanning voltage:	approx. + 5 V DC against "com"; continuous signal	
Loop resistance:	max. 1 kilohm for safe detection of a "1" signal (rising edge)	

Output

Number:	1
Switch type:	Power MOS-FET, phase cut-on or cut-off
Rated voltage:	230 V AC +/- 10 % 50 / 60 Hz
Rated current:	0.9 A
Connectable load:	50 – 210 W / VA
Minimum load:	50 W / VA (output connected!)
Total power loss:	max. 2 W
Cable type:	2 x H05 V-K 0.5 mm ² with tinned ends / connect in compliance with installation prescriptions using the push-lock terminals supplied with the device.
Cable length:	approx. 20 cm ready-made
Dimmable loads:	230 V incandescent lamps : phase cut-off HV halogen lamps : phase cut-off LV lamps with TRONIC transformers : phase cut-off LV lamps with conventional transformers : phase cut-on

Loads consisting of a mix of the specified loads can also be connected to the device. Do not mix capacitive and inductive loads.

If mixed loads are used with conventional transformers, the share of resistive loads connected (incandescent lamps, HV halogen lamps) must not exceed 50 %.

The connected load including transformer losses must not exceed the permissible total load.

Response to voltage failure:	Outputs:	depending on parameterization "parameter description")
	Inputs:	no reaction
Response to bus voltage return:	Outputs:	depending on parameterization (cf. "Parameter description")
	Inputs:	depending on parameterization (cf. "Parameter description")

Type of protection	IP 20
Safety class:	III
Mark of approval:	KNX / EIB
Ambient temperature:	-5 °C ... +45 °C
Storage / transport temperature:	-25 °C ... +70 °C (storage above +45 °C reduces the lifetime)
Mounting position:	any
Minimum distances:	none
Type of fastening:	e.g. placing in deep flush-mounting box (∅ 60 mm x 60 mm)

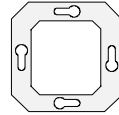

Wiring diagram and terminals

Load connection:

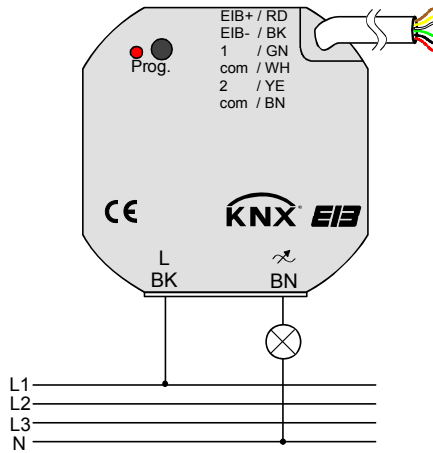

Bus connection and connection of extensions:

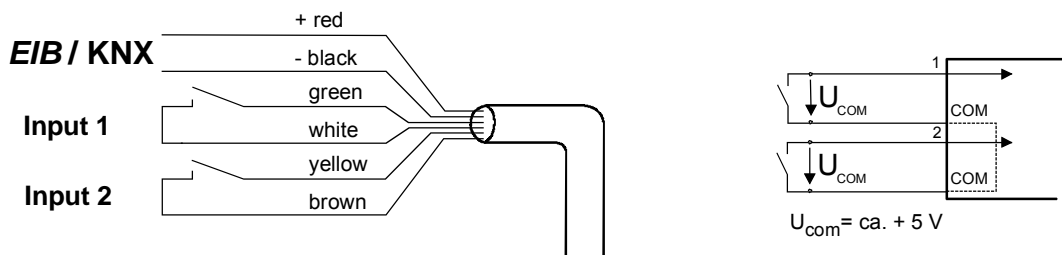

A spacing of 4 mm minimum between extra low-voltage lines (bus and extension inputs) and the load lines (230 V) must be ensured (see fig. A).

It is recommended to install the universal dimming actuator in two interconnected flush-mounting boxes (see fig. B). Besides the bus and extension terminals, box (A) can, for instance, also accommodate a two-circuit switch (C). The other box (B) accommodates the universal dimming actuator and the 230 V terminals. The 6-wire connecting cable (D) is led through the box junction. The reference potential "com" can be interconnected with the reference potentials of other universal dimming actuators UP of the same design.

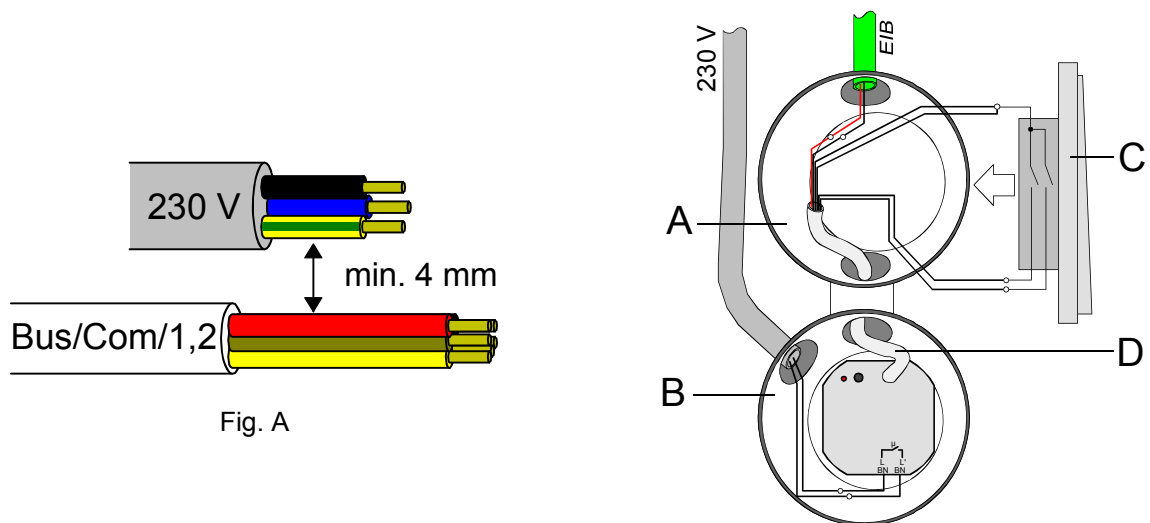
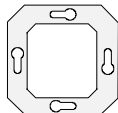

Fig. A

Fig. B

instabus KNX/EIB System

Actuator



Hardware information

Dimming output:

- After the installation and after switching on of the mains voltage, the universal dimming actuator auto-detects the load characteristics of the connected consumer and selects the appropriate dimming principle.

230 V incandescent lamps	: phase cut-off
HV halogen lamps	: phase cut-off
LV lamps with TRONIC transformers	: phase cut-off
LV lamps with conventional transformers	: phase cut-on

Loads consisting of a mix of the specified loads can also be connected to the device.

Caution: Do not connect capacitive (e.g. electronic transformers) together with inductive loads (e.g. conventional transformers) to the dimming actuator.

Do not connect motors to the device.

If mixed loads are used with conventional transformers, the share of resistive loads connected (incandescent lamps, HV halogen lamps) must not exceed 50 %. Conventional transformers must be operated with at least 85% of their rated load. The connected load including transformer losses must not exceed the permissible total load.

The auto-detection procedure may be accompanied by brief flickering of the lamps and lasts between 1 and 10 seconds depending on power supply conditions. KNX/EIB commands received during the auto-detection phase will be executed on completion of this phase.

- Mains failures of more than 0.7 seconds will result in the dimming actuator shutting off. After return of the mains voltage, the device repeats the load auto-detection procedure.
- In the event of short-circuit or overload, the load is disconnected in permanence after 7s in the phase cut-off mode (capacitive and resistive loads) and after 100 ms in the phase cut-on mode (inductive loads). After removal of the short-circuit or overload, the dimming actuator must at first be deactivated via the bus (switching command "OFF" or "Brightness value = "0") or disconnected from the mains (also load failure or bus reset) before it can be switched on again.
- The output is switched off when the ambient temperature is too high. After cooling down, the dimming actuator repeats the auto-detection procedure and starts with the brightness preset by the KNX/EIB.

Extension inputs and bus connection:

-  Never connect mains voltage (230 V) or other external voltages to the extension inputs. Connecting an external voltage endangers the electrical safety of the entire KNX/EIB system (SELV / no electrical insulation). Persons may be put at risk and devices and installations may be irreparably damaged.
- Make sure during the installation that there is always sufficient insulation between mains voltage and the bus or the extensions. A minimum spacing of 4 mm must be ensured between the bus/extension wires and the mains wires.
- Non-used wires of the 6-wire connecting cable must be insulated with respect to one another and with respect to external voltages.
- To avoid EMC disturbances, the lines to the inputs should not be laid parallel to lines and cables carrying mains voltage.

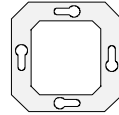

Software information

ETS search path:

Gira Giersiepen / illumination / dimmer / universal dimming actuator FM 210 W

ETS symbol:

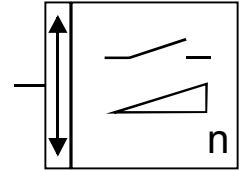

Application:

Summarized description:

Name:

Date:

Page:

Version:

Single-channel switching and dimming with Dimming, 2 x inputs 301901
time functions, disabling functions, light-
scenes and checkback function. Two
additional extension inputs.

02.07

5

10589190

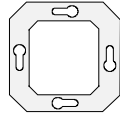

Application: Dimming, 2 x inputs 301901

Scope of functions

Inputs:

General

- Mode of functioning of the inputs parameterizable:
 - acting as extension inputs directly on the dimming output:
double-sided actuation: input 1 → brighter - ON / input 2 → darker – OFF
(corresponds to condition of device on delivery)
 - acting as general binary inputs separately on the bus

Function as binary inputs to the bus

- Switching, dimming, shutter/blind and value transmitter functions freely assignable to the max. 2 inputs
- Disable object for disabling of individual inputs (polarity of disable object presettable)
- Delay on return of bus voltage and debouncing time centrally adjustable
- Response to bus voltage return separately parameterizable for each input
- Telegram rate limitation generally parameterizable for all inputs

Switching function

- Two independent switching objects available for each input (switching commands individually parameterizable)
- Command for rising and falling edge individually adjustable (ON, OFF, TOGGLE, no reaction).
- Independent cyclical transmission of switching objects depending on edge or on object value selectable.

Dimming function

- Single-sided and double-sided actuation
- Time between dimming and switching and dimming step width presettable
- Telegram repetition and stop telegram transmission possible

Shutter/blind function

- Command for rising edge adjustable (no function, UP, DOWN, TOGGLE)
- Operation concept parameterizable ("Step - Move – Step" resp. "Move – Step")
- Time between short-time and long-time operation presettable (only with "Step - Move - Step")
- Slat adjustment time presettable (time during which a "Move" command can be terminated by releasing a push-button on the input)

Value transmitter and light-scene extension functions

- Nature of edge (push-button as n.o. contact, push-button as n.c. contact, switch) and value of edge parameterizable
- Value change in push-button mode possible with long press on the button for value transmitter
- In light-scene extension with storage function, a light-scene can be stored without preceding recall

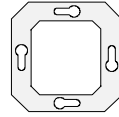

Output:

- Switching and dimming of lamps
- Switch-on and dimming response presettable with parameters
- Switching status checkback possible via separate communication object
- Adjusted brightness value checkback possible via separate communication object or via brightness value object (T-flag set)
- "Soft-ON", "Soft-OFF" and time dimmer parameterizable
- Gradual or direct approach to selected brightness levels
- Time-delayed shut-off possible when brightness drops below shut-off brightness level
- Short-circuit message (also overload) and load failure message (also mains failure) possible
- Light-scene operation (recall of up to eight internally stored brightness levels as light-scenes)
- Disable mode can be activated via an object with parameterized brightness value at the beginning and at the end of the disable mode
- Response of the dimming actuator to failure and return of bus voltage adjustable
- Delay on return of bus voltage centrally adjustable

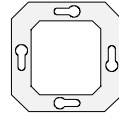

Number of addresses (max):	26	dynamic table handling	Yes <input checked="" type="checkbox"/>	No <input type="checkbox"/>
Number of assignments (max):	27	maximum number of assignments	53	
Communication objects:	19			

Objects for the binary inputs (extension inputs), if acting on the bus:

Function: no function (for both inputs ²⁾)

No further input objects

Function: Switching (for both inputs ²⁾)

Object	Function	Name	Format	Flag
<input checked="" type="checkbox"/> 1 – 2	Switching object X.1 (X = 1 to 2)	Input 1 – Input 2	1 bit	C, W, T, (R) ¹
<input checked="" type="checkbox"/> 9 – 10	Switching object X.2 (X = 1 to 2)	Input 1 – Input 2	1 bit	C, W, T, (R) ¹

Function: Dimming (for both inputs ²⁾)

Object	Function	Name	Format	Flag
<input checked="" type="checkbox"/> 1 – 2	Switching	Input 1 – Input 2	1 bit	C, W, T, (R) ¹
<input type="checkbox"/> 9 – 10	Dimming	Input 1 – Input 2	4 bit	C, T, (R) ¹

Function: Shutter (for both inputs ²⁾)

Object	Function	Name	Format	Flag
<input type="checkbox"/> 1 – 2	Short operation (STEP)	Input 1 – Input 2	1 bit	C, T, (R) ¹
<input type="checkbox"/> 9 – 10	Long operation (MOVE)	Input 1 – Input 2	1 bit	C, T, (R) ¹

Function: Value transmitter (function: dimming value transmitter for both inputs ²⁾)

Object	Function	Name	Format	Flag
<input type="checkbox"/> 1 – 2	Value	Input 1 – Input 2	1 byte	C, T, (R) ¹

Function: Value transmitter (Function: Light-scene extension with/without storage function for all 2 inputs ²⁾)

Object	Function	Name	Format	Flag
<input type="checkbox"/> 1 – 2	Light-scene extension	Input 1 – Input 2	1 byte	C, T, (R) ¹

Function: Sperren (für alle 2 Eingänge ³⁾)

Object	Function	Name	Format	Flag
<input checked="" type="checkbox"/> 17 – 18	Disabling	Input 1 – Input 2	1 bit	C, W, (R) ¹



Objects for the dimming output:

Function: Output

Object	Function	Name	Format	Flag
☐ 0	Switching	Output	1 bit	C, W, (R) ¹
☐ 3	Dimming	Output	4 bit	C, W, (R) ¹
☐ 4	Brightness value ⁴	Output	1 byte	C, W, T, (R) ¹
☐ 5	Switching checkback	Output	1 bit	C, T, (R) ¹
☐ 6	Brightness value checkback ⁴	Output	1 byte	C, T, (R) ¹
☐ 7	Disabling	Output	1 bit	C, W, (R) ¹
☐ 11	Light-scene extension	Output	1 byte	C, W, (R) ¹
☐ 12	Short-circuit message	Output	1 bit	C, T, (R) ¹
☐ 13	Load failure message	Output	1 bit	C, T, (R) ¹

- 1: Objects marked (R) permit read-out of the current object status (set R-flag).
- 2: The "No function", "Switching", "Dimming", "Shutter/blind" and "Value transmitter" functions can be selected per input. The names of the communication objects and the object table (dynamic object structure) will change accordingly.
- 3: A disable function is not available if the function of the inputs is parameterized for "No function"
- 4: The current brightness value is internally retained in the brightness value object. If the parameter "*Value response object activated?*" = NO and if the T-flag is set, the current brightness value will be transmitted via brightness value object 4, when the brightness changes. If the brightness value response object (object 6) is activated, there will be no active checkback via object 4.

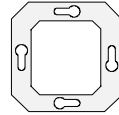

Functional description for the inputs

Mode of functioning

The universal dimming actuator is equipped with two extension inputs which - depending on parameterization - can act directly on the dimming output (local control) or alternatively on the KNX/EIB as independent binary inputs.

In the state as delivered (unprogrammed actuator), the extension inputs act directly on the dimming output. For this reason, the actuator can be commissioned and operated already 'on site' only by connecting the bus voltage and without needing sensors.

- Inputs acting on dimming output

The extension inputs only act directly and internally on the dimming output of the actuator. In double-sided actuation, input 1 is used to increase the brightness or to switch ON and input 2 to reduce the brightness or to switch OFF. The dimming output is controlled as follows:

Input	Contact at input	Actuation *	Relay switching state
1	closed (rising edge)	short	switching on (with switch-on brightness)
	opened (falling edge)	long ---	increase brightness no reaction or dimming stop **
2	closed (rising edge)	short	switching off
	opened (falling edge)	long ---	reduce brightness no reaction or dimming stop **

*: The time after which a long-time operation is executed (time between switching and dimming) is fixed at approx. 520 ms.

** : Opening of the contact at the input after the start of a dimming cycle (> 520 ms) immediately ends the cycle (stop command). Opening of the contact shows no reaction if the dimming cycle has not yet been performed (< 520 ms).

For direct action, the extension inputs do not have parameters of their own so that the parameter cards for the inputs are not available. Operating both inputs simultaneously is not possible!

After return of bus voltage, the actuator responds to changes of the extension signal status only after the time parameterized for the "Delay after bus voltage return" has elapsed.

During the delay, pulse edges or signals present at the inputs are not evaluated and disregarded. The time of delay is generally parameterized for all inputs and also for the outputs.

It is possible to parameterize a general telegram rate limitation. In this case, no telegram will be transmitted to the KNX/EIB within the first 17 s after return of the bus voltage, for instance, in case of control from the extensions and an enabled switching status checkback for the output.

instabus KNX/EIB System

Actuator



- Inputs acting separately on the bus

The inputs of the universal dimming actuator act independently of the dimming output and separated from one another on the KNX/EIB. Depending on parameterization, the functions "Switching", "Dimming", "Blind/shutter" or "Value transmitter" can be selected for each input (cf. "Parameter description"). When "No function" is selected, the corresponding input is deactivated.

When the "Dimming" setting is selected, the extension objects can be combined via group addresses with the objects of the dimming outputs. The actuator can thus be controlled via its own inputs even if the extension signals are set for acting on the bus (e.g. group control of several universal dimming actuators).

The functional description of the inputs on the following pages is valid only if the extensions are set for acting on the bus.

Dimming value transmitter: change by means of long key press

In the event of dimming value transmitter parameterization, the value to be transmitted can be changed by means of a long key-press (> 5 s) if the value is to be transmitted on the rising or the falling edge. In this case, the programmed value is increased by the parameterized step width and transmitted. After releasing of the input contact, the value last transmitted remains stored. On the next long key-press, the direction of value change is reversed.

Example:

Value (0...255) 17
Step width (1...10) 5

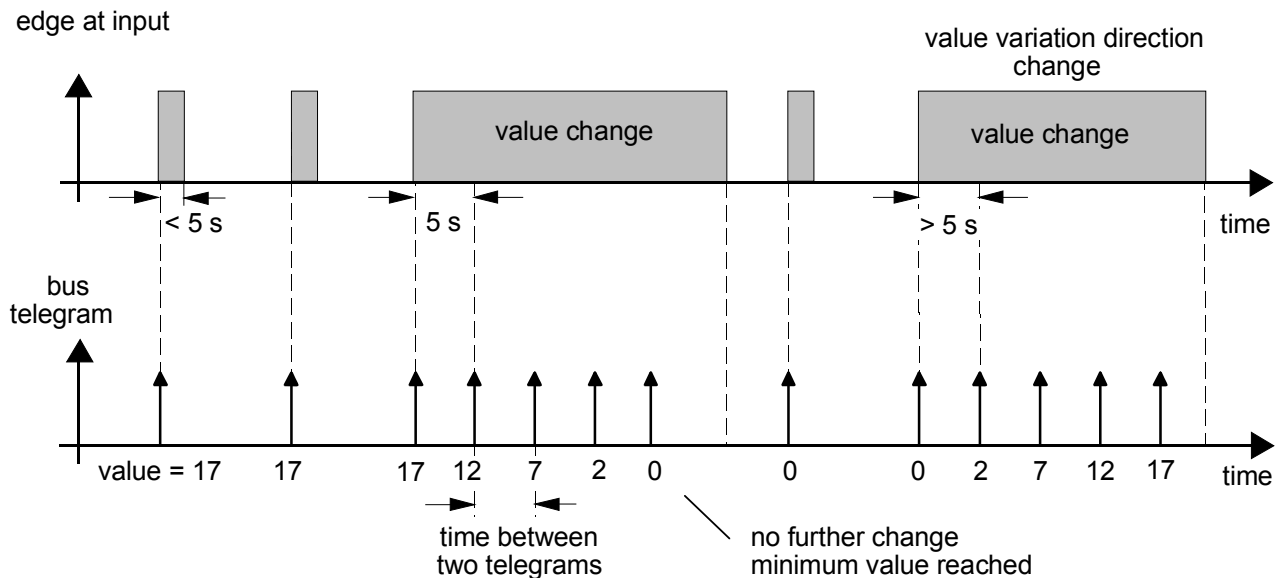

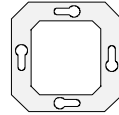
**Notes:**

- There is no overrun and no underrun during value variation. When the maximum (255) resp. the minimum (0) value is reached during a variation cycle, no more telegrams are transmitted.
- To ensure that the concerned lighting switches off or on with the max. value during a value variation, the limit values (values "0" resp. "255") are always transmitted when the limits of the variation range are reached. This is also the case when the parameterized step width does not directly account for these values (cf. example above: step width = 5; value "2" is transmitted, thereafter value "0").
To ensure that the original starting value can be set again during a new change (change of variation direction), the first value jump will not correspond to the preset step width (cf. example above: step width = 5; value "0" is transmitted, thereafter values "2", "7" etc.).
- When values are changed, the newly set values are stored in the RAM.
After a bus voltage failure or a bus reset, the changed values will be replaced by the values originally parameterized in the ETS.

Light-scene extension with / without storage function

In a parameterization as light-scene extension without storage function it is possible to recall a light-scene. In case of a rising edge, a falling edge or a rising and a falling edge, the parameterized light-scene number is transmitted immediately.

In a parameterization as light-scene extension with storage function it is possible to generate a storage telegram depending on the light-scene to be transmitted. A long actuation of the n.o. contact (rising edge) or of the n.c. contact (falling edge) causes the corresponding storage telegram to be transmitted. In this case, the time for a long press is parameterizable (however not below 5 s). After a short press < 1 s, the parameterized light-scene number (without storage telegram) is transmitted. If the actuation is longer than 1 s, but shorter than 5 s, no telegram will be transmitted at all. In addition, it is possible to transmit only a storage telegram without preceding light-scene recall. In this case, the "Storage function only" parameter must be set to "YES".

Examples for light-scene extension with storage function:

- 1.) storage function only = NO:
- 2.) storage function only = YES:

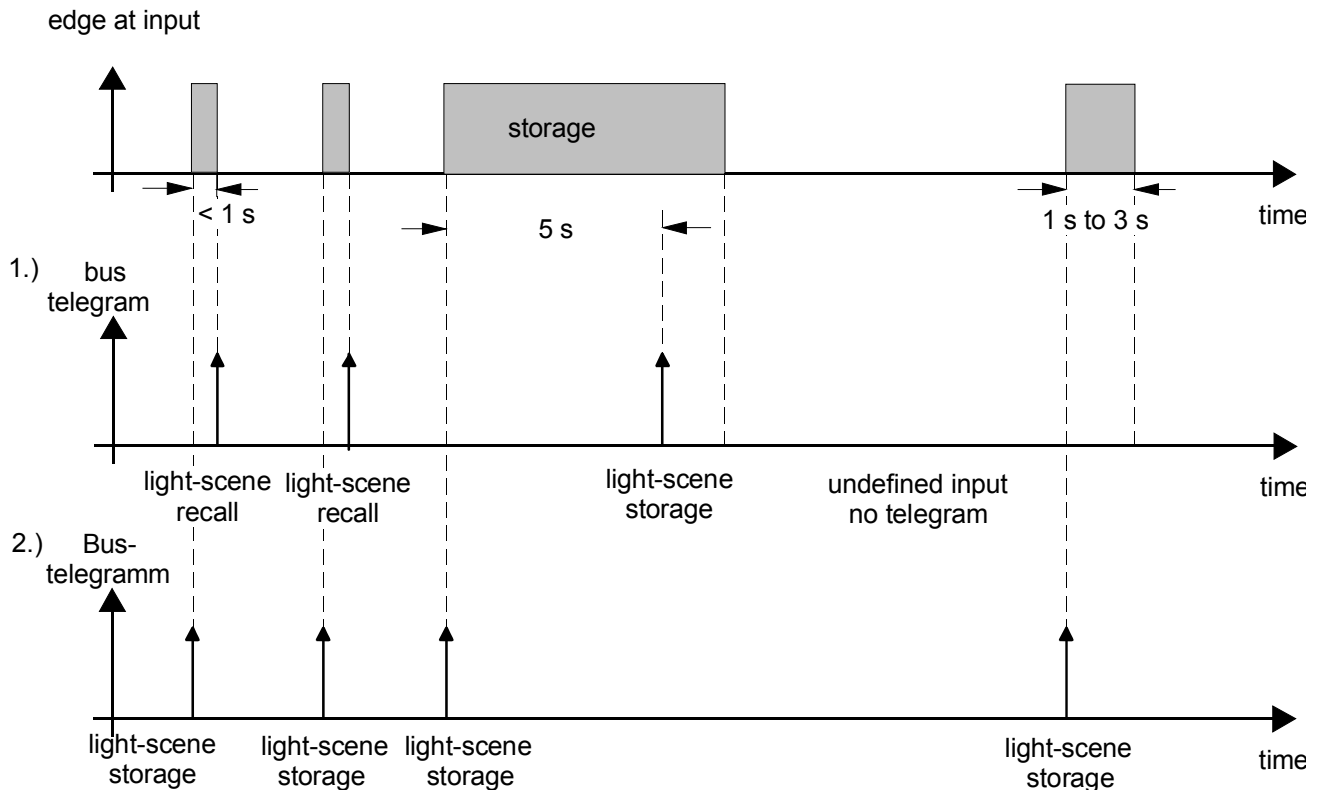
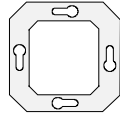

storage function only = NO:

If a rising or a falling edge is detected at the input (depending on parameterization), the timer is started. If the key is released within the first second, the corresponding light-scene is recalled immediately. If the key is pressed longer, the storage telegram is transmitted after 5 s.

storage function only = YES:

The storage telegram is transmitted immediately after detection of the corresponding edge.

Response to bus voltage return

It is possible to specify separately for each input whether a reaction or what kind of reaction is to take place on return of bus voltage. Thus, a defined telegram can be transmitted to the bus depending on the input signal or by forced control.

The defined reaction takes place only after the parameterized "Delay after bus voltage return" has elapsed. During the delay, pulse edges or signals present at the inputs are not evaluated and disregarded. The time of delay is generally parameterized for all inputs and also for the outputs.

It is possible to parameterize a general telegram rate limitation. In this case, no telegram is transmitted within the first 17 s after bus voltage return.

It should be noted that the parameterized "delay on return of bus voltage" is active during this period as well. The parameterized reaction on return of bus voltage occurs, however, only after the 17 seconds have elapsed.

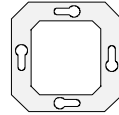

Disable function

Each input can be independently configured for a certain reaction at the beginning or at the end of disable. It is also possible to parameterize the input for "No reaction". Only in this case will dimming or shutter control procedures or value changes in progress before activation of the disable function continue to be executed until the end when disable is active. In all other cases, the parameterized command will be transmitted immediately at the beginning of disable. During an active disable, edges or signals at the corresponding inputs are not evaluated.

Updates on disable objects (disable or enable) will always lead to the transmission of the corresponding command parameterized for "the beginning resp. the end of disable".

During an active disable, no cyclical transmission takes place via the disabled input.

If cyclical transmission did take place before activation of the disable function, no cyclical transmission will take place anymore at the end of disable when "No reaction" is parameterized. In this case, the object value will again be transmitted cyclically only after an update on the switching object. In all other cases, the object value will again be transmitted cyclically after the end of disable.

Cyclical transmission

The object value transmitted is always the object value retained internally or externally in the switching objects. For this reason, the object value is transmitted cyclically even if "No reaction" is assigned to a rising or a falling edge.

Cyclical transmission takes place also directly after the return of bus voltage, if the parameterized value of the telegram after bus voltage return corresponds to the object value parameterization for cyclical transmission. If telegram rate limitation is enabled, cyclical transmission will occur at the earliest after 17 seconds.

During an active disable, no cyclical transmission takes place via the disabled input.



Description of output functions

Response to bus voltage failure or response on return of bus voltage

The behaviour of the dimming output in case of bus voltage failure is parametrizable. The connected lighting can thus either be switched off or adjusted to a predefined brightness level. Alternatively, the setting "no change" has the effect that the preset brightness does not change in the event of bus voltage failure.

The behaviour of the dimming output in case of bus voltage return is parametrizable in the same way. The connected lighting can thus either be switched off or adjusted to a predefined brightness level. Alternatively, the lighting conditions that were active before bus voltage failure can be maintained (setting: "Brightness level at the time of bus voltage failure"). Any brightness changes that were started before bus voltage failure, will be accounted for by time functions (Soft-ON, Soft-OFF, Time dimmer, Switch-off function) After programming with the ETS, the "Value at bus voltage failure" is = "0".

The preset reaction to bus voltage return will only occur after the parameterized "delay on bus voltage return" has elapsed. During the delay period, the output is off and does not show any reaction. The actuator can, however, be controlled via the bus. Updates of the switching and brightness value object (also by light-scenes) during the delay period are stored and executed only after the delay has elapsed. Any control commands reaching the actuator from the extensions during the delay period are without function.

It is possible to parameterize a general telegram rate limitation. In this case, no telegrams are transmitted via the reporting and response objects within the first 17 s after return of bus voltage. It should be noted that the parameterized "delay on return of bus voltage" is active during this period as well. The parameterized reaction on return of bus voltage takes place, however, only after the delay period has elapsed. In this case, however, the checkback concerning the states of the actuator is transmitted only after 17 seconds.

A short-circuit message and the load failure message will be updated on return of the bus voltage with their new state and transmitted to the bus. The bus transmission will be effected, however, only after the "Delay on return of bus voltage" (if parameterized) has elapsed.

A disable function activated before bus voltage failure is always deactivated after the return of bus voltage.

Disable function

The dimming actuator can be disabled via the bus so that the preset brightness value remains constant during an activated disable state. At the beginning and at the end of the disable state, the actuator can be set to a parameterized brightness (cf. also the description of the disable function parameters).

A disable function activated before bus voltage failure is always deactivated after the return of bus voltage. During the delay period after return of bus voltage, the output is off and shows no reaction. The actuator can, however, be controlled via the bus. Updates of the disable object during the delay period will be stored and executed only after the delay has elapsed.

Brightness value object

The currently set brightness value is retained in the brightness value object. If the R-flag of this object is set, the current value can be read out. A transmission of the brightness value by setting the C-flag is possible, if the parameter "Value response object available ?" is set to "NO".

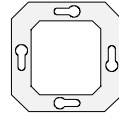

Short-circuit message / load failure

Short-circuit message:

In case of malfunctions, the dimming actuator is capable of transmitting various 1-bit messages to the bus. If the actuator detects a short-circuit or an overload on the consumer side, the load will be definitely disconnected after 7s in phase cut-off operation (capacitive and resistive loads) and after 100 ms in phase cut-on operation (inductive loads). In this case, an "ON" telegram can be transmitted via the "short-circuit" message object at the time the device is switched off. The short-circuit message is activated by the parameter setting "Report short-circuit? = Yes" and the corresponding communication object is enabled.

After removal of the short-circuit or the overload condition, the dimming actuator must at first be switched off via the bus in order to avoid accidental reactivation. The device can be switched off either by an "OFF" switching command or by a brightness value = "0" (also from light-scene).

The load is reactivated as usual via bus control. If the short-circuit is then no longer existing, an "OFF" telegram will be transmitted via the "short-circuit" message object after 7 seconds. If the short-circuit condition is still persisting, the message remains active.

On the other hand, a short-circuit message is reset when the mains voltage is switched off and on again and in case of a load failure or a bus reset.

Load failure message:

If the dimming actuator detects an open-circuit condition on the consumer side (e.g. filament of light bulb defective or mains fuse blown in a transformer) or a mains failure with the load connected, the actuator can transmit a 1-bit load failure message to the bus. In this case, an "ON" telegram is transmitted as soon as a failure is detected. The reporting function is enabled by the parameter setting "Report load failure ? = Yes" and the communication object is indicated.

An "OFF" telegram will be transmitted via the "load failure" message object only after the load failure condition has been corrected (e.g. by replacing the defective bulb or fuse). After a load failure, the universal dimming actuator re-adapts itself automatically to the load and adjusts the lamp to the previous brightness or to the brightness value retained during the failure.

Information on short-circuit or load failure messaging:

- If both, short-circuit and load failure messaging is used, the message telegrams behave as follows:
If a load failure is signalled via the "load failure" message object ("ON"), this message will be followed immediately by an "OFF" telegram transmitted by the actuator to the bus via the "short-circuit" message object. This sequence ensures that a short-circuit message transmitted before will be "reset" by a load failure (for instance by a mains shut-off).
If a short-circuit is signalled via the "short-circuit" message object ("ON"), this message will be followed immediately by an "OFF" telegram transmitted by the actuator to the bus via the "load failure" message object. This sequence ensures that a load failure message transmitted before will be "reset" by a short-circuit.
- As a short-circuit will result in the connected lamp being switched off, this malfunction also has an effect on the brightness status of the dimming actuator. In the event of a short-circuit, a switching status message "OFF" and/or a value response "0" will therefore be transmitted to the bus. After rectification of the fault and after reactivation, the actuator updates the response values in accordance with the adjusted brightness.
A load failure does not result in the load being shut off automatically and therefore has no effect on switching status or value checkbacks of the dimming actuator.
- The short-circuit and the load failure message will be updated on return of the bus voltage with their new state and transmitted to the bus. The bus transmission will be effected, however, only after the "Delay on return of bus voltage" (if parameterized) has elapsed. It is possible to parameterize a general telegram rate limitation. In this case, no telegrams will be transmitted via the message objects within the first 17 s after bus voltage return.

Actuator



Checkback of switching status / dimming value

If the switching state of the dimming actuator changes from "OFF" to "ON" or from "ON" to "OFF", a corresponding switching telegram will be transmitted to the bus via the switching status checkback object. If the "Soft-ON" function is activated and started, an "ON" response telegram is transmitted once at the beginning of a dimming cycle. If the "Soft-OFF" function is activated and started, an "ON" response telegram is transmitted at the beginning of a dimming cycle. An "OFF" response telegram will be sent only after the dimming cycle has ended. If the "Soft-OFF" function is started by an elapsed time dimmer function, an "OFF" response telegram will be transmitted to the bus only after the dimming cycle has ended.

A corresponding switching status response telegram will also be sent in the event of value updates of the switching objects ("OFF" to "OFF" or "ON" to "ON").

As soon as a brightness value has been received via the brightness value object or is being preset via the switching or dimming object and when this brightness value is constant (dimming cycle finished), a telegram will be transmitted via the value response object or via the brightness value object (depending on the parameter "Value checkback parameter available?").

In the event of updates of the brightness value object (e.g. from value "70" to value "70") no checkback will be sent.

The response object value will be updated after the return of the bus voltage when the delay has elapsed and transmitted actively to the bus. With the telegram rate limitation enabled, no telegram will be transmitted via the response object within the first 17 s after return of bus voltage. The checkback is stored and will be transmitted when the 17 s delay has elapsed.

If applicable, the object status can be read out by a visualization software (set R-flag).

Delivery state

In the state as delivered (unprogrammed actuator), the extension inputs act directly on the dimming output. For this reason, the actuator can be commissioned and operated already 'on site' only by connecting the bus voltage and without needing sensors.

The output remains off when the bus voltage is applied. The actuator responds to state changes of the extension signals only after 390 ms (delay after bus voltage return).

During the delay after the return of bus voltage, pulse edges or signals present at the inputs are not evaluated and disregarded.

When the bus voltage is applied, the extension inputs control the dimming output as follows:

Input	Contact at input	Actuation *	Relay switching state
1	closed (rising edge)	short	switching on (100 %)
	opened (falling edge)	long	increase brightness
2	closed (rising edge)	---	no reaction or dimming stop **
	opened (falling edge)	short	switching off
	closed (rising edge)	long	reduce brightness
	opened (falling edge)	---	no reaction or dimming stop **

*: The time after which a long-time operation is executed (time between switching and dimming) is fixed at approx. 520 ms.

** : Opening of the contact at the input after the start of a dimming cycle (> 520 ms) immediately ends the cycle (stop command). Opening of the contact shows no reaction if the dimming cycle has not yet been performed (< 520 ms).

Operating both inputs simultaneously is not possible!

In the event of bus voltage failure, the actuator shows no reaction. No time functions are active. No group addresses are preprogrammed at the factory.

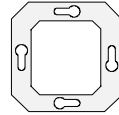

Parameters		
Description	Values:	Comment:
 General		
Input action	inputs acting together on dimming output inputs acting separately on bus	Defines whether the extension inputs of the actuator act directly on the dimming output (local operation) or, as an alternative, separately as binary inputs on the KNX/EIB. The input parameter cards are visible only if "Action = separate action on bus" has been selected. The setting "Action = combined action on dimming output" corresponds to the delivery state.
Delay on return of bus voltage Base	130 ms 34 s 260 ms 1,1 min 520 ms 2,2 min 1 s 4,5 min 2,1 s 9 min 4,2 s 18 min 8,4 s 35 min 17 s 1,2 h	After return of bus voltage, the application program of the universal switching actuator can be disabled for a defined period of time until the corresponding reactions take place. During this time, no signals present on the inputs will be evaluated and the dimming output will not be activated either. An checkback signal, too, will be transmitted at the earliest after the end of the delay. Defines the time base of the delay period. $Time = Base \cdot Factor$
Delay on return of bus voltage Factor (3... 127)	3 to 127, 17	Defines the time factor of the delay period. $Time = Base \cdot Factor$ Presetting: 1 s ; 17 = 17 s
Debouncing time for binary inputs Factor (10...255) * 0.5 ms	0 to 255, 60	Defines the software debouncing time for all binary inputs in common. A signal edge at the input will be evaluated with a delay corresponding to the time defined. $Time = 0.5 \text{ ms} \cdot Factor$ Presetting: 0.5 ms · 20 = 10 ms
Telegram rate limitation	enabled disabled	The telegram rate limitation can be enabled or disabled. When the telegram rate limitation is enabled, no telegrams will definitely be transmitted in the first 17 s after bus voltage return.

instabus KNX/EIB System

Actuator



General		
Telegrams per 17 s	30 60 100 127	When the telegram rate limitation is enabled, the maximum number of telegrams within 17 s can be preset here.
Output 1		
Basic brightness (brightness value = 1) (depending on lamp)	level 1 level 2 level 3 (incandescent lamps) level 4 level 5 (standard halogen) level 6 level 7 level 8	Adaptation of basic brightness (lowest dimming level / brightness value = 1) to local conditions Level 1 is the lowest basic brightness.
Response to bus voltage failure:	OFF basic brightness 10% 20% 30% 40% 50% 60% 70% 80% 90% maximum brightness no change	Defines the behaviour of the device in case of bus voltage failure.
Response to bus voltage return	OFF basic brightness 10% 20% 30% 40% 50% 60% 70% 80% 90% maximum brightness brightness value at bus voltage failure	Defines the behaviour of the device in case of bus voltage return. If the setting is "Brightness value at bus voltage failure", the lights will be switched on with the brightness value that was active before bus voltage failure. The value is stored permanently in an EEPROM After programming with the ETS, the value is "0"

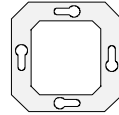



Output 1		
Switch-on brightness: Switching on with	basic brightness 10% 20% 30% 40% 50% 60% 70% 80% 90% maximum brightness brightness value before last shut-off	Defines the switch-on brightness on reception of an ON telegram via object 0. If the setting is "Brightness value before last shut-off", the lights will be switched on with the brightness value that was active before last shut-off via the switching object. If the actuator was already off before the last shut-off (brightness value = 0) or if the device has been programmed with the ETS, the "Brightness before last shut-off" is = "1" (basic brightness).
Response on reception of a value	go direct to brightness value approach brightness value gradually	Defines whether a brightness value received is to be set by gradual approach via object 4 or by directly.
Time between 2 out of 255 dimming steps, Base	0,5 ms 2,1 s 8 ms 33 s 130 ms	Defines the time base valid for 2 of the 255 dimming steps. The relative dimming speed is set by changing the length of the dimming steps. Time = Factor · Base
Time between 2 out of 255 dimming steps, Factor	3...255, 24	Time factor for the interval between two dimming steps Presetting: 24 · 0.5 ms = 12 ms
Shutoff function	YES NO	Defines whether the dimming actuator is to shut off after a parametrizable time on reaching a constant brightness which is below a presettable shut-off brightness. <p>brightness value</p> <p>shutoff brightness value</p> <p>time delay</p> <p>basic brightness value</p> <p>time</p> <p>telegram darker or brightness value</p> <p>end of dimming control (e.g. stop-telegramm)</p>

instabus KNX/EIB System

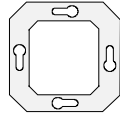
Actuator



 Ausgang 1				
Shutoff at brightness value below	5 % 10 % 15 % 20 % 25 % 30 % 35 % 40 %	45 % 50 % 55 % 60 % 65 % 70 % 75 % 80 %	85 % 90 % 95 % maximum brightness	On reaching a constant brightness below this shut-off brightness, the dimming actuator switches off after a parametrizable time delay
Delay until shut-off, Base	0,5 ms 8 ms 130 ms	2,1 s 33 s		Base of shut-off delay. Time delay = Base · Factor
Delay until shut-off, Factor	3...255, 10			Factor of shut-off delay. Presetting: 10 · 130 ms = 1.3 s
 Output 1, Enable				
Time functions ?	YES NO			Defines whether the parameters for the soft functions and / or the time dimmer functions are to be enabled.
Disable function	YES NO			Defines whether the parameters for the disable function are to be enabled.
Light-scenes ?	YES NO			Defines whether the parameters for the light-scene function are to be enabled.
Checkback switching status ?	YES NO			Defines whether the switching status is to be checkbackd.
Value response object available ?	YES NO			Defines whether the dimming value is to be checkbackd via the value response object (YES) or via the brightness value object (NO). For an checkback via the brightness value object, the C-flag must have been set.
Report short-circuit ?	YES NO			Defines whether a short-circuit or an overload is to be reported.
Report load failure ?	YES NO			Defines whether a load failure or a mains failure is to be reported.

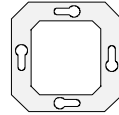

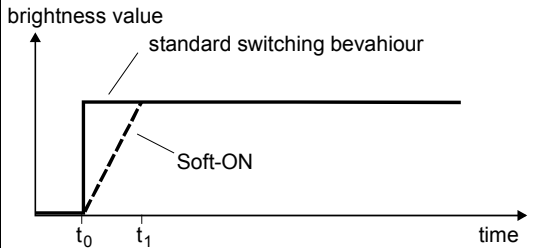
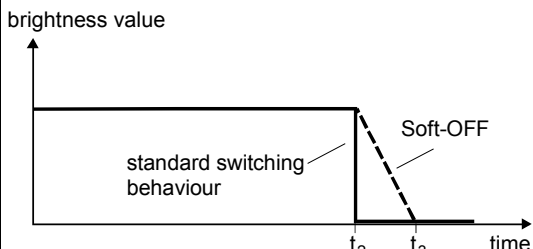
Output 1, Time functions		
"Soft-ON" function ?	YES NO	Defines whether the Soft-ON function is activated.
Soft-ON time for a dimming step, Base	0,5 ms 2,1 s 8 ms 33 s 130 ms	Setting for slower switch-on: Increase brightness up to the parameterized switch-on brightness (non retriggerable)  $t_1 - t_0$: time for Soft-ON Time base of a dimming step with Soft-ON Time = Base · Factor
Soft-ON time for a dimming step, Factor (3...255)	3...255, 24	Time factor of a dimming step with Soft-ON Presetting: $24 \cdot 0,5 \text{ ms} = 12 \text{ ms}$
"Soft-OFF" function ?	YES NO	Defines whether the Soft-OFF function is activated.
Soft-OFF time for a dimming step	0,5 ms 2,1 s 8 ms 33 s 130 ms	Setting for slower shut-off: Reduce brightness until shut-off (non retriggerable)  $t_3 - t_2$: time for Soft-OFF Time base of a dimming step with Soft-OFF Time = Base · Factor
Soft-OFF time for a dimming step Factor (3...255)	3...255, 24	Time factor of a dimming step with Soft-OFF Presetting: $24 \cdot 0,5 \text{ ms} = 12 \text{ ms}$

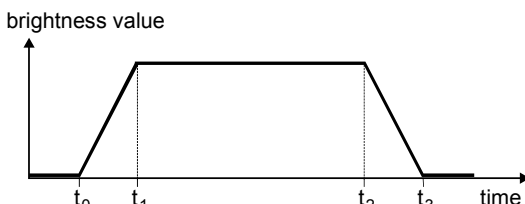

 Output 1, Time functions		
Activate time dimmer function (staircase function)?	YES NO	The time dimmer starts a timer switch function when switched on (ON telegram). When the preset time delay has elapsed, the dimming actuator is automatically switched off (retriggerable) The Soft-ON and the Soft-OFF function can also be activated. The time dimmer function can be stopped prematurely with an OFF command.  $t_1 - t_0$: time for Soft-ON (optional) $t_2 - t_1$: time between ON and OFF $t_3 - t_2$: time for Soft-OFF (optional)
Time between ON and OFF Base	0,5 ms 2,1 s 8 ms 33 s 130 ms	Time delay = Base · Factor
Time between ON and OFF Factor(3...255)	3...255, 80	Time delay = Base · Factor Presetting: 80 · 130 ms = 10.4 s
Disabling object polarity	non-inverted (disable = 1; enable = 0) inverted (disable = 0; enable = 1)	The dimming actuator is disabled when the disable object value = 1. The dimming actuator is disabled when the disable object value = 0.
Brightness at the beginning of disable	OFF basic brightness 10% 20% 30% 40% 50% 60% 70% 80% 90% maximum brightness no action brightness value before last shut-off	Defines the brightness value set at the output at the beginning of disable. When "no action" is selected, the brightness currently set remains active. If "brightness value before last shutoff" was selected, the lights will be switched on at the beginning of disable with the brightness value that was active before the last shutoff via the switching object. If the actuator was already off before the last shutoff (brightness value = 0) or if the device has been programmed with the ETS, the "brightness before last shutoff" is = "1" (basic brightness).



Output 1, Light-scenes		
Brightness for light-scene 1	OFF basic brightness 10% 20% 30% 40% 50% 60% 70% 80% 90% maximum brightness	Setting of the brightness value for light-scene 1 Only with "Representation of the light-scene values = as a percentage"
Brightness for light-scenes 2 - 8	see light-scene 1	
Storage function	YES NO	Defines whether a brightness set with a dimming actuator can be stored as a light-scene.
Input 1 (only if "Input action = separately on bus")		
Function of input 1	no function switching dimming blind/shutter value transmitter	Defines the function of input 1.
Function of input 1 = "no function"		
		No further parameters
Function of input 1 = "Switching"		
Command on rising edge Switching object 1.1	no reaction ON OFF TOGGLE	Defines the command transmitted with a rising edge via switching object 1.1. "TOGGLE" switches over the object value.

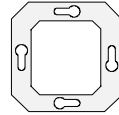

Input 1 (only if "Input action = separately on bus")		
Function of input 1 = "Switching"		
Command on falling edge Switching object 1.1	no reaction ON OFF TOGGLE	Defines the command transmitted with a falling edge via switching object 1.1. "TOGGLE" switches over the object value.
Command on rising edge Switching object 1.2	no reaction ON OFF TOGGLE	Defines the command transmitted with a rising edge via switching object 1.2. "TOGGLE" switches over the object value.
Command on falling edge Switching object 1.2	no reaction ON OFF TOGGLE	Defines the command transmitted with a falling edge via switching object 1.2. "TOGGLE" switches over the object value.
Response to bus voltage return	no reaction transmit current input status transmit ON telegram transmit OFF telegram	Permits defining the reaction that is to take place after return of bus voltage. The parameterized delay after return of bus voltage must have elapsed before the action defined will be executed. No reaction The current state of the inputs corresponding to the parameterization for rising and falling edge will be transmitted. Transmits an ON signal. Transmits an OFF signal.
Cyclical transmission?	no cyclical transmission repeat when ON repeat when OFF repeat when ON and OFF	Cyclical transmission can be realized via the switching objects depending on the object value. No cyclical transmission. Cyclical transmission active when the object value is "ON". Cyclical transmission active when the object value is "OFF". Cyclical transmission always active independent of object value.



Input 1 (only if "Input action = separately on bus")			
Function of input 1 = "Switching"			
Time base for cyclical transmission Switching object 1.1	1 sec 2.1 s 4.2 s 8.4 s 17 s 34 s 1.1 min 34 s	1.1 min 2.2 min 4.5 min 9 min 18 min 35 min 1.2 h	Defines the time base for cyclical transmission via switching object 1.1. Time = Base · Factor
Time base for cyclical transmission Switching object 1.2	1 s 2.1 s 4.2 s 8.4 s 17 s 34 s 1.1 min 34 s	1.1 min 2.2 min 4.5 min 9 min 18 min 35 min 1.2 h no cyclical transmission via switching object X.2	Defines the time base for cyclical transmission via switching object 1.2. Cyclical transmission via switching object 1.2 can be disabled when "No cyclical transmission via switching object X.2" is selected. Time = Base · Factor
Time base for cyclical transmission Switching object 1.1 and 1.2 Factor (3... 127)	3 to 127, 60		Defines the time base for cyclical transmission via both switching objects. Time = Base · Factor Presetting: 1 s · 60 = 60 s
Input 1, Disable (HA)			
Disabling function (HA)	enabled disabled		The disable function can be enabled or disabled.
Disabling object polarity (HA)	disable = 1 (enable = 0) disable = 0 (enable = 1)		This parameter defines the polarity of the disable object.
Response at the beginning of disable Switching objects 1.1 and 1.2 (HA)	no reaction ON OFF TOGGLE		When disable is active, both switching object are disabled. This parameter defines the command transmitted at the beginning of disable via both switching objects. "TOGGLE" toggles the object values.
Response at the end of disable Switching objects 1.1 and 1.2 (HA)	no reaction ON OFF transmit current input status		When disable is active, both switching object are disabled. This parameter defines the command transmitted at the end of disable via both switching objects. With "Transmit current input status", the current input status will be transmitted corresponding to the parameterization for the rising and the falling edge.

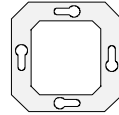

Input 1 (only if "Input action = separately on bus")		
Function of input 1 = "Dimming"		
Operation	<p>Single-button actuation: brighter/ darker (TOGGLE)</p> <p>double- button actuation: brighter (ON)</p> <p>Double- button actuation: darker (OFF)</p> <p>double- button actuation: brighter (TOGGLE)</p> <p>Double- button actuation: darker (OFF)</p>	<p>Defines the response to a rising edge at the input.</p> <p>After a brief press on the button at the input, the object value of the switching object is toggled and a corresponding telegram transmitted. A long press triggers a dimming telegram (brighter / darker). The dimming direction is stored only internally and toggled for successive dimming cycles.</p> <p>A short press on the button at the input sends an ON telegram, whereas a long press triggers a dimming telegram (brighter).</p> <p>A short press on the button at the input sends an OFF telegram, whereas a long press triggers a dimming telegram (darker).</p> <p>A short press on the button at the input toggles the object value of the switching object and sends a corresponding telegram, whereas a long press triggers a dimming telegram (brighter).</p> <p>A short press on the button at the input toggles the object value of the switching object and sends a corresponding telegram, whereas a long press triggers a dimming telegram (darker).</p>
Time between switching and dimming Base	130 ms 260 ms 520 ms 1 sec	Time after which the dimming function is executed ("long press"). Time = Base · Factor
Time between switching and dimming Factor (3... 127)	4 to 127, 4	Time after which the dimming function is executed ("long press"). Time = Base · Factor Presetting: 130 ms · 4 = 520 ms

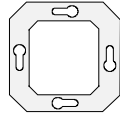

Input 1 (only if "Input action = separately on bus")		
Function of input 1 = "Dimming"		
Response to bus voltage return	<p>no reaction</p> <p>transmit ON telegram</p> <p>transmit OFF telegram</p>	<p>Permits defining the reaction that is to take place after return of bus voltage. If a delay after return of bus voltage has been parameterized, this delay must have elapsed before the reaction defined occurs.</p> <p>No reaction</p> <p>ON signal is transmitted.</p> <p>OFF signal is transmitted.</p>
Increase brightness by	<p>100 % 6 %</p> <p>50 % 3 %</p> <p>25 % 1.5 %</p> <p>12.5 %</p>	<p>A dimming telegram permits increasing the brightness by a max. value of X %. This parameter defines the max. dimming step width of a dimming telegram. The parameter is independent of the preset mode of operation.</p>
Reduce brightness by	<p>100 % 6 %</p> <p>50 % 3 %</p> <p>25 % 1.5 %</p> <p>12.5 %</p>	<p>A dimming telegram permits reducing the brightness by a max. value of X %. This parameter defines the max. dimming step width of a dimming telegram. The parameter is independent of the preset mode of operation.</p>
Transmit stop telegram ?	<p>YES</p> <p>NO</p>	<p>When a button at the input is released (falling edge), a stop telegram is transmitted or not.</p>
Repeat telegram ?	<p>YES</p> <p>NO</p>	<p>Cyclical repetition of dimming telegrams during a long press.</p>
Time between two telegrams Base	<p>130 ms</p> <p>260 ms</p> <p>520 ms</p> <p>1 sec</p>	<p>Time between two telegrams when telegram repetition is selected. After this time, a new dimming telegram will be sent. Only if "Repeat telegram ?" = "YES".</p> <p>Time = Base · Factor</p>
Time between two telegrams Factor (3... 127)	<p>3 to 127, 10</p>	<p>Time between two telegrams when telegram repetition is selected. After this time, a new dimming telegram will be sent. Only if "Repeat telegram ?" = "YES".</p> <p>Time = Base · Factor</p> <p>Presetting: 130 ms · 10 = 1.3 s</p>

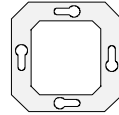

Input 1, Disable (HA)		
Disabling function (HA)	enabled disabled	The disable function can be enabled or disabled.
Disabling object polarity (HA)	disable = 1 (enable = 0) disable = 0 (enable = 1)	This parameter defines the polarity of the disable object.
Response at the beginning of disable (HA)	no reaction ON OFF TOGGLE	This parameter defines the command transmitted at the beginning of disable via the switching object. "TOGGLE" toggles the object values.
Response at the end of disable (HA)	no reaction OFF	This parameter defines the command transmitted at the end of disable via the switching object.
Input 1 (only if "Input action = separately on bus")		
Function of input 1 = "Blind/shutter"		
Command on rising edge	no function OFF ON TOGGLE	Defines the response to a rising edge at the input. Input deactivated. A brief press triggers a STEP telegram (UP), a long press triggers a MOVE telegram (up). A brief press triggers a STEP telegram (DOWN), a long press triggers a MOVE telegram (down). This setting toggles the travel direction internally for each long press (MOVE). When a STEP telegram is transmitted by a brief press, this STEP always occurs in opposite direction to the last MOVE. Several successive STEP telegrams occur in the same direction.
Response to bus voltage return	no reaction UP DOWN	Permits defining the reaction that is to take place after return of bus voltage. If a delay after return of bus voltage has been parameterized, this delay must have elapsed before the reaction defined will be executed. No reaction Transmits a MOVE (UP) command. Transmits a MOVE (DOWN) command.



<p> Input 1 (only if "Input action = separately on bus")</p>		
<p> Function of input 1 = "Blind/shutter"</p>		
<p>Operating concept</p>	<p>step – move – step</p>	<p>Defines the telegram sequence after a key-press (rising edge).</p> <p>Step – Move – Step:</p> <p>A rising edge sends a STEP and time T1 (time between short- and long-time operation) is started. This STEP serves the purpose of stopping a continuous move. When a falling edge is detected within T1, the binary input sends no further telegram.</p> <p>If no falling edge has been detected during T1, the binary input automatically sends a MOVE after T1 and starts time T2 (slat adjusting time). If a falling edge is then detected within T2, the binary input sends a STEP. This function is used for the adjustment of the slats. T2 should correspond to the time required for a slat rotation through 180°.</p>
	<p>move - step</p>	<p>Move - Step:</p> <p>A rising edge at the input sends a MOVE and time T1 (slat adjusting time) is started. If a falling edge is detected within T1, the binary input sends a STEP. This function is used for the adjustment of the slats. T1 should correspond to the time needed for a slat rotation through 180°.</p>

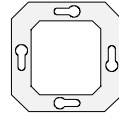

Input 1 (only if "Input action = separately on bus")			
Function of input 1 = "Blind/shutter"			
Time between short- and longtime operation Base	130 ms 260 ms 520 ms 1 s 2,1 s 4,2 s	8,4 s 17 s 34 s 1,1 min 34 s	Time after which the long-time operation function is executed. Only with operation concept = "Step - Move -Step". Time = Base · Factor
Time between short- and longtime operation Factor (4... 127)	4 to 127, 4		Time after which the long-time operation function is executed. Only with operation concept = "Step - Move -Step". Time = Base · Factor Presetting: 130 ms · 4 = 520 ms
Slat adjustment time Base	130 ms 260 ms 520 ms 1 s 2,1 s 4,2 s	8,4 s 17 s 34 s 1,1 min 34 s	Time during which a MOVE telegram for slat adjustment can be terminated by releasing the push-button at the input Time = Base · Factor
Slat adjustment time Factor (3... 127)	3 to 127, 20		Time during which a MOVE telegram for slat adjustment can be terminated by releasing the push-button at the input Time = Base · Factor Presetting: 130 · 20 ms = 2.6 s
Input 1, Disable (HA)			
Disabling function (HA)	enabled disabled		The disable function can be enabled or disabled.
Disabling object polarity (HA)	disable = 1 (enable = 0) disable = 0 (enable = 1)		This parameter defines the polarity of the disable object.
Response at the beginning of disable (HA)	no reaction ON OFF TOGGLE		This parameter defines the command transmitted at the beginning of disable via the long-time object. "TOGGLE" toggles the travel direction last executed (stored internally).
Response at the end of disable (HA)	no reaction ON OFF TOGGLE		This parameter defines the command transmitted at the end of disable via the long-time object. "TOGGLE" toggles the travel direction last executed (stored internally).

Actuator



Input 1 (only if "Input action = separately on bus")		
Function of input 1 = "Value transmitter"		
Function as	dimming value transmitter light-scene recall without memory function light-scene recall with storage function	Defines the function to be executed.
Value transmitter function = "Dimming value transmitter"		
Transmit value	on rising edge (push-button as n.o. contact) on falling edge (push-button as n.c. contact) on rising and falling edge (switch)	Defines the edge that triggers an action.
Value on rising edge (0...255)	0 to 255, 100	Defines the value transmitted on a rising edge. Only if "Transmit value = on rising edge (push-button as n.o. contact)" and "Transmit value = on rising and falling edge (switch)"
Value on falling edge (0...255)	0 to 255, 0	Defines the value transmitted on a falling edge. Only if "Transmit value = on falling edge (push-button as n.c. contact)" and "Transmit value = on rising and falling edge (switch)".

Actuator

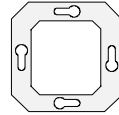

Response to bus voltage return	<p>no reaction</p> <p>reaction as with rising edge</p> <p>reaction as with falling edge</p> <p>transmit current input status</p>	<p>Permits defining the reaction that is to take place after return of bus voltage. If a delay after return of bus voltage has been parameterized, this delay must have elapsed before the reaction defined occurs.</p> <p>No reaction</p> <p>The value parameterized for the rising edge will be transmitted.</p> <p>Only if "Transmit value = on rising edge (push-button as n.o. contact)" and "Transmit value = on rising and falling edge (switch)"</p> <p>The value parameterized for the falling edge will be transmitted.</p> <p>Only if "Transmit value = on falling edge (push-button as n.c. contact)" and "Transmit value = on rising and falling edge (switch)".</p> <p>The current state of the inputs corresponding to the parameterization for rising and falling edge will be transmitted.</p> <p>Only if "Transmit value = on rising and falling edge (switch)".</p>
Value change by long press?	<p>YES</p> <p>NO</p>	<p>With a long press (< 5 s), the current value can be cyclically reduced or increased by the parameterized step width (see below) and transmitted. After this value variation, the value last transmitted remains stored. The parameter defines whether a value change is possible.</p> <p>Only if "Transmit value = on rising edge (push button as n.o. contact)" and "Transmit value = on falling edge (push button as n.c. contact)"</p>
Time between two telegrams Base	<p>130 ms</p> <p>260 ms</p> <p>520 ms</p> <p>1 sec</p>	<p>Time base for the time between two cyclical telegrams for value change.</p> <p>Only if "Value change by long press ? = YES"</p>
Time between two telegrams Factor (3... 127)	<p>3 to 127, 3</p>	<p>Time factor for the time between two cyclical telegrams for value change.</p> <p>Only if "Value change by long press ? = YES"</p> <p>Time = Base · Factor</p> <p>Presetting: 520 · 3 ms = 1.56 s</p>



Step width (1...10)	1 to 10, 10	Width of the step by which the set value will be reduced or increased by a long press. Only if "Value change by long press ? = YES"
 Input 1, Disable (HA)		
Disabling function (HA)	enabled disabled	The disable function can be enabled or disabled.
Disabling object polarity (HA)	disable = 1 (enable = 0) disable = 0 (enable = 1)	This parameter defines the polarity of the disable object.
Response at the beginning of disable (HA)	<p>no reaction</p> <p>reaction as with rising edge</p> <p>reaction as with falling edge</p> <p>transmit current input status</p>	<p>This parameter defines the reaction taking place at the beginning of disable.</p> <p>No reaction</p> <p>The value parameterized for the rising edge will be transmitted. Only if "Transmit value = on rising edge (push-button as n.o. contact)" and "Transmit value = on rising and falling edge (switch)"</p> <p>The value parameterized for the falling edge will be transmitted Only if "Transmit value = on falling edge (push-button as n.c. contact)" and "Transmit value = on rising and falling edge (switch)".</p> <p>The current state of the inputs corresponding to the parameterization for rising and falling edge will be transmitted. Only if "Transmit value = on rising and falling edge (switch)".</p>

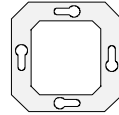

Input 1, Disable (HA)		
Response at the end of disable (HA)	<p>no reaction</p> <p>reaction as with rising edge</p> <p>reaction as with falling edge</p> <p>transmit current input status</p>	<p>This parameter defines the reaction taking place at the end of disable.</p> <p>No reaction</p> <p>The value parameterized for the rising edge will be transmitted.</p> <p>Only if "Transmit value = on rising edge (push-button as n.o. contact)" and "Transmit value = on rising and falling edge (switch)"</p> <p>The value parameterized for the falling edge will be transmitted</p> <p>Only if "Transmit value = on falling edge (push-button as n.c. contact)" and "Transmit value = on rising and falling edge (switch)".</p> <p>The current state of the inputs corresponding to the parameterization for rising and falling edge will be transmitted.</p> <p>Only if "Transmit value = on rising and falling edge (switch)".</p>
Input 1 (only if "Input action = separately on bus")		
Function of input 1 = "Value transmitter"		
Value transmitter function = "Light-scene extension without storage function"		
Transmit light-scene number	<p>on rising edge (push-button as n.o. contact)</p> <p>on falling edge (push-button as n.c. contact)</p> <p>on rising and falling edge (switch)</p>	Defines the edge that triggers an action.
Light-scene on rising edge (1...64)	1 to 64, 1	<p>Defines the light-scene transmitted on a rising edge.</p> <p>Only if "Transmit light-scene number = on rising edge (push-button as n.o. contact)" and "Transmit value = on rising and falling edge (switch)"</p>

instabus KNX/EIB System

Actuator

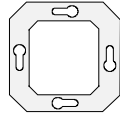

Light-scene on falling edge (1...64)	1 to 64, 1	<p>Defines the light-scene transmitted on a falling edge.</p> <p>Only if "Transmit light-scene number = on falling edge (push-button as n.c. contact)" and "Transmit value = on rising and falling edge (switch)"</p>
Response to bus voltage return	<p>no reaction</p> <p>reaction as with rising edge</p> <p>reaction as with falling edge</p> <p>transmit current input status</p>	<p>Permits defining the reaction that is to take place after return of bus voltage. If a delay after return of bus voltage has been parameterized, this delay must have elapsed before the reaction defined occurs.</p> <p>No reaction</p> <p>The light-scene parameterized for the rising edge will be transmitted.</p> <p>Only if "Transmit light-scene number = on rising edge (push button as n.o. contact)" and "Transmit light-scene number = on rising and falling edge (switch)"</p> <p>Defines the light-scene transmitted on a falling edge.</p> <p>Only if "Transmit light-scene number = on falling edge (push button as n.c. contact)" and "Transmit light-scene number = on rising and falling edge (switch)"</p> <p>The current state of the inputs corresponding to the parameterization for rising and falling edge will be transmitted.</p> <p>Only if "Transmit light-scene number = on rising and falling edge (switch)"</p>
<p> Input 1, Disable (HA)</p>		
Disabling function (HA)	<p>enabled</p> <p>disabled</p>	<p>The disable function can be enabled or disabled.</p>
Disabling object polarity (HA)	<p>disable = 1 (enable = 0)</p> <p>disable = 0 (enable = 1)</p>	<p>This parameter defines the polarity of the disable object.</p>

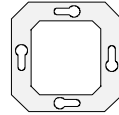

 Input 1, Disable (HA)		
Response at the beginning of disable (HA)	<p>no reaction</p> <p>reaction as with rising edge</p> <p>reaction as with falling edge</p> <p>transmit current input status</p>	<p>This parameter defines the reaction taking place at the beginning of disable.</p> <p>No reaction</p> <p>The value parameterized for the rising edge will be transmitted.</p> <p>Only if "Transmit value = on rising edge (push-button as n.o. contact)" and "Transmit value = on rising and falling edge (switch)"</p> <p>The value parameterized for the falling edge will be transmitted</p> <p>Only if "Transmit value = on falling edge (push-button as n.c. contact)" and "Transmit value = on rising and falling edge (switch)".</p> <p>The current state of the inputs corresponding to the parameterization for rising and falling edge will be transmitted.</p> <p>Only if "Transmit value = on rising and falling edge (switch)".</p>
Response at the end of disable (HA)	<p>no reaction</p> <p>reaction as with rising edge</p> <p>reaction as with falling edge</p> <p>transmit current input status</p>	<p>This parameter defines the reaction taking place at the end of disable.</p> <p>No reaction</p> <p>The value parameterized for the rising edge will be transmitted.</p> <p>Only if "Transmit value = on rising edge (push-button as n.o. contact)" and "Transmit value = on rising and falling edge (switch)"</p> <p>The value parameterized for the falling edge will be transmitted</p> <p>Only if "Transmit value = on falling edge (push-button as n.c. contact)" and "Transmit value = on rising and falling edge (switch)".</p> <p>The current state of the inputs corresponding to the parameterization for rising and falling edge will be transmitted.</p> <p>Only if "Transmit value = on rising and falling edge (switch)".</p>

instabus KNX/EIB System

Actuator



	Input 1 (only if "Input action = separately on bus")	
	Function of input 1 = "Value transmitter"	
	Value transmitter function = "Light-scene extension with storage function"	
Transmit light-scene number	on rising edge (push-button as n.o. contact) on falling edge (push-button as n.c. contact)	Defines the edge that triggers an action.
Light-scene on rising edge (1...64)	1 to 64, 1	Defines the light-scene transmitted on a rising edge. Only if "Transmit light-scene number = on rising edge (push-button as n.o. contact)"
Light-scene on falling edge (1...64)	1 to 64, 1	Defines the light-scene transmitted on a falling edge. Only if "Transmit light-scene number = on falling edge (push-button as n.c. contact)"
Response to bus voltage return	no reaction reaction as with rising edge reaction as with falling edge	Permits defining the reaction that is to take place after return of bus voltage. If a delay after return of bus voltage has been parameterized, this delay must have elapsed before the reaction defined occurs. No reaction The light-scene parameterized for the rising edge will be transmitted. Only if "Transmit light-scene number = on rising edge (push-button as n.o. contact)" Defines the light-scene transmitted on a falling edge. Only if "Transmit light-scene number = on falling edge (push-button as n.c. contact)"
Storage function only ?	YES NO	It is possible to send only a storage telegram without preceding light-scene recall.
Time of a long press for storage Base	130 ms ¹⁾ 260 ms ²⁾ 520 ms ³⁾ 1 s ⁴⁾	Time base for the time of a long press to transmit a storage telegram. Only if "Storage function only? = NO" Time = Base · Factor

Actuator

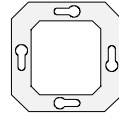

Time of a long press for storage Factor (24...127) ¹⁾ Factor (13...127) ²⁾ Factor (9...127) ³⁾ Factor (4...127) ⁴⁾	24 to 127, 38 ¹⁾ 13 to 127, 19 ²⁾ 9 to 127, 10 ³⁾ 4 to 127, 5 ⁴⁾	Time factor for the time of a long press to transmit a storage telegram Only if "Storage function only? = NO" Time = Base · Factor Presetting: 520 ms · 10 = 5.2 s Note: Important: The factor range depends on the selected base. Therefore, only times > 3 s can be parameterized.
Input 1, Disable (HA)		
Disabling function (HA)	enabled disabled	The disable function can be enabled or disabled.
Disabling object polarity (HA)	disable = 1 (enable = 0) disable = 0 (enable = 1)	This parameter defines the polarity of the disable object.
Response at the beginning of disable (HA)	no reaction reaction as with rising edge reaction as with falling edge	This parameter defines the reaction taking place at the beginning of disable. No reaction The value parameterized for the rising edge will be transmitted. Only if "Transmit value = on rising edge (push-button as n.o. contact)" The value parameterized for the falling edge will be transmitted Only if "Transmit value = on falling edge (push-button as n.c. contact)"
Response at the end of disable (HA)	no reaction reaction as with rising edge reaction as with falling edge	This parameter defines the reaction taking place at the end of disable. No reaction The value parameterized for the rising edge will be transmitted. Only if "Transmit value = on rising edge (push-button as n.o. contact)" The value parameterized for the falling edge will be transmitted Only if "Transmit value = on falling edge (push-button as n.c. contact)"
Input 2 see input 1!		