

Issue:
08.03.2011
63yz0x20

Blind actuator 2-gang 230 V AC
Blind actuator 4-gang 230 V AC
Blind actuator 8-gang 230 V AC

Order-No. 2152 00

Order-No. 1039 00

Order-No. 2161 00

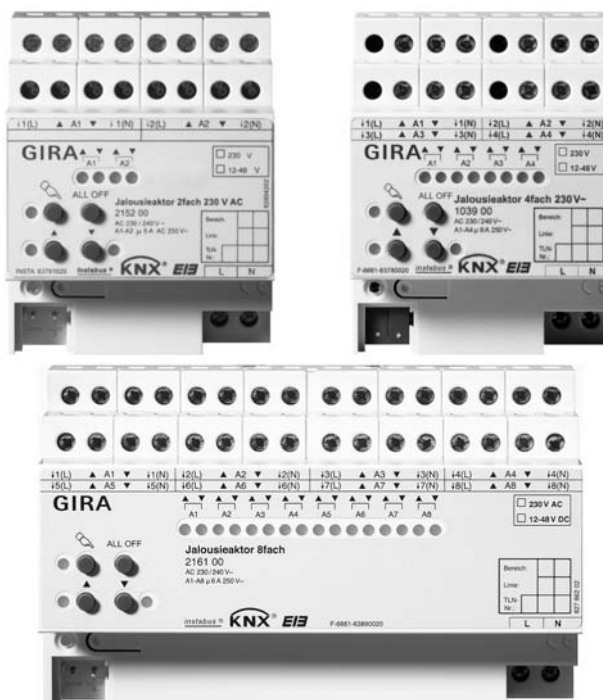

Contents

1	<u>Product definition</u>	<u>3</u>
1.1	Product catalogue	3
1.2	Function	3
2	<u>Fitting, electrical connection and operation</u>	<u>4</u>
2.1	Safety instructions	4
2.2	Device components	5
2.3	Fitting and electrical connection	7
2.4	Commissioning	12
2.5	Operation	15
3	<u>Technical data</u>	<u>18</u>
4	<u>Software description</u>	<u>19</u>
4.1	Software specification	19
4.2	Software "Venetian blind"	22
4.2.1	Scope of functions	22
4.2.2	Software information	23
4.2.3	Object table	24
4.2.4	Functional description	33
4.2.4.1	Description of channel-independent functions	33
4.2.4.2	Channel-oriented functional description	40
4.2.4.3	Delivery state	97
4.2.5	Parameters	98
5	<u>Appendix</u>	<u>137</u>
5.1	Index	137

1 Product definition

1.1 Product catalogue

Product name: Shutter/blind actuator 2fold 230 V AC / 1fold 12-48 V DC DRA / Shutter/blind actuator 4fold 230 V AC / 2fold 12-48 V DC DRA / Shutter/blind actuator 8fold 230 V AC / 4fold 12-48 V DC DRA

Use: Actuator

Design: Rail-mounted device (REG)

Order-No. 2152 00 / 1039 00 / 2161 00

1.2 Function

The Venetian blind actuator receives telegrams from sensors or other controllers using the KNX/EIB and, together with the independent relay contacts, it switches electrically-powered Venetian blinds, roller shutters, awnings, venting louvres or similar blinds for mains voltage 230 V AC (4 or 8-channel, depending on the device) or low voltage 12...48 V DC (either 1, 2 or 4-channel, depending on the device). Each relay output is equipped with mains-operated monostable switching relays so that the preferred contact positions are maintained also during bus voltage failure.

The controls (4 pushbuttons) on the front panel of the device permit switching the relays on and off by hand in parallel with the KNX / EIB even without bus voltage or in a non-programmed state. This feature permits fast checking of connected motors for proper functioning.

The function properties settable independently for each output channel using the ETS comprise, for example, separately configurable movement times, alternatively an automatic limit position detection for 230 V drives with mechanical limit position switches, expanded feedback functions, allocations to up to 5 different safety functions, a sun protection function for a wide range of requirements, and the link to scenes of forced movements (scenes or forced movements for 4/8-channel device movement only from ETS3.0d). Centralised control of all outputs is also possible. Moreover, the preferred states of the relays in case of bus voltage failure or bus / mains voltage return and after ETS programming can be preset separately.

For project design and commissioning of this device, we recommend using the ETS3.0 from Version d patch A. The advantages with regard to downloading (shorter loading times) are available only if this ETS version or later versions are used. In addition, the full scope of functions with the 4/8-channel device variant is only possible from ETS3.0d onwards. For ETS2 and older versions of ETS3, a separate product database is available.

The shutter actuator has its own mains supply independent of the connected drives. For actuation of the outputs, the 230 V mains supply must always be switched on. The integrated bus coupler is supplied from the bus voltage or the mains voltage, meaning that the device can only be programmed using the ETS when the KNX/EIB bus voltage is switched on. The device is designed for mounting on DIN rails in closed compact boxes or in power distributors in fixed installations in dry rooms.

2 Fitting, electrical connection and operation

2.1 Safety instructions

Electrical equipment may only be installed and fitted by electrically skilled persons. The applicable accident prevention regulations must be observed.

Failure to observe the instructions may cause damage to the device and result in fire and other hazards.

Before working on the device or exchanging the connected loads, disconnect it from the power supply (switch off the miniature circuit breaker), otherwise there is the risk of an electric shock.

The blind actuator is not suited for safe disconnection of the mains.

For parallel connection of several drives to an output it is indispensable to observe the corresponding instructions of the manufacturers. There is otherwise risk of irreparable damage to the drives.

Use only curtains with mechanical or electronic limit switches. Check the limit switches for correct adjustment.

Do not connect mains voltage and SELV / PELV circuits to the same blind actuator.

Do not connect any three-phase motors.

Make sure during the installation that there is always sufficient insulation between the mains voltage and the bus. A minimum distance of at least 4 mm must be maintained between bus conductors and mains voltage cores.

The device may not be opened or operated outside the technical specifications.

2.2 Device components

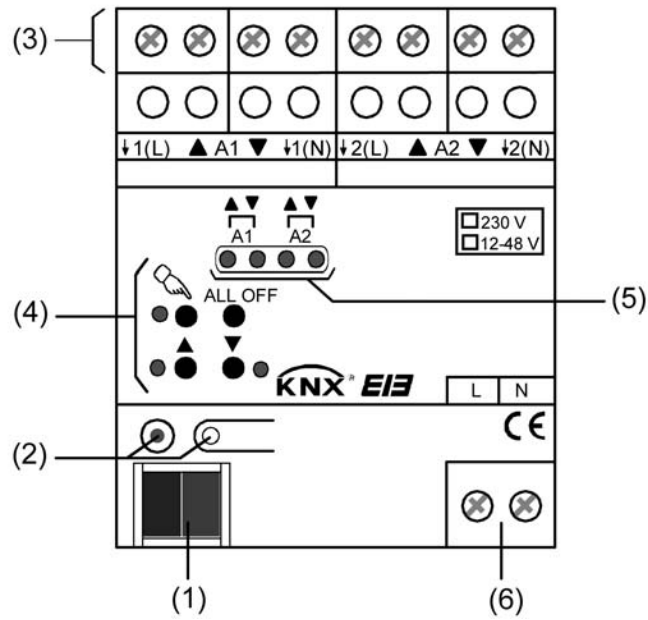

Figure 1: Device components of the shutter actuator 1/2-channel REG

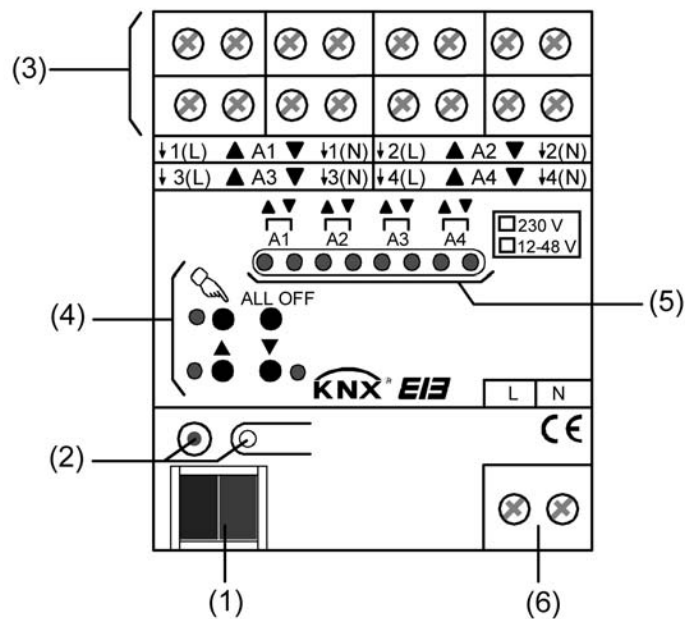

Figure 2: Device components of the shutter actuator 2/4-channel REG

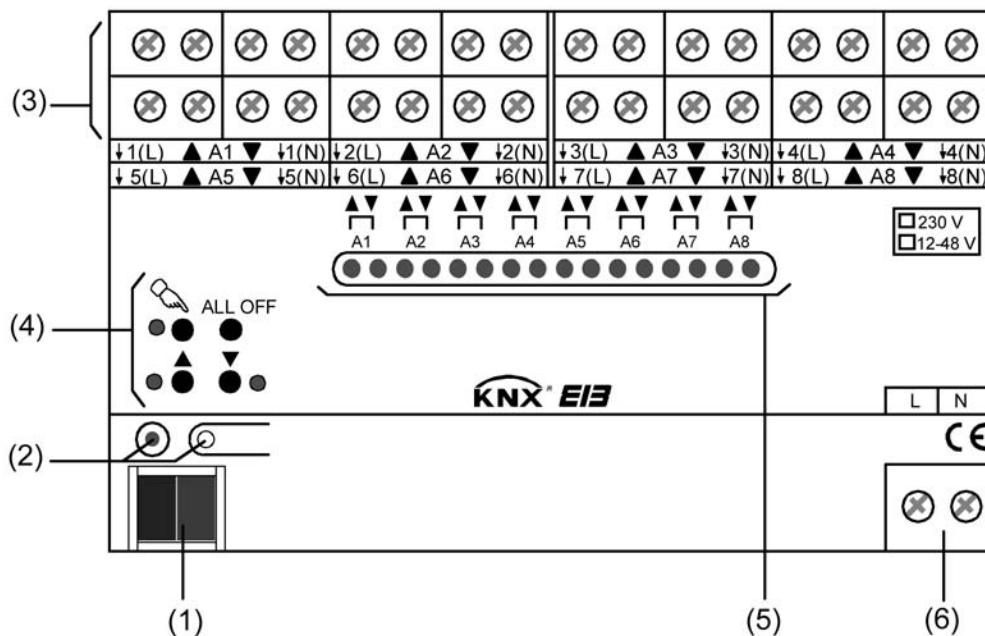

Figure 3: Device components of the shutter actuator 4/8-channel REG

- (1) KNX/EIB bus connection
- (2) Programming button and programming LED (red). The programming LED flashes slowly when the safe-state mode is active.
- (3) Screw terminal for connection of the motors.
- (4) Button field for manual control
- (5) Status LED of the outputs with direction display (2 LEDs for each output):
 LED off: output switched off
 LED on: Output switched on (movement up "▲" or movement down "▼")
 LED flashing slowly: output in manual control
 LED flashing quickly: output blocked by manual control
- (6) Mains voltage terminal for power supply to the device electronics

Dimensions of shutter actuator 1/2-channel REG:

Width (W): 72 mm (4 modules) / height (H): 90 mm / depth (D): 70 mm

Dimensions of shutter actuator 2/4-channel REG:

Width (W): 72 mm (4 modules) / height (H): 90 mm / depth (D): 70 mm

Dimensions of shutter actuator 4/8-channel REG:

Width (W): 144 mm (8 modules) / height (H): 90 mm / depth (D): 70 mm

2.3 Fitting and electrical connection



DANGER!

Electrical shock when live parts are touched.

Electrical shocks can be fatal.

Before working on the device, disconnect the power supply and cover up live parts in the working environment.



CAUTION!

Danger of destruction if several drives are connected in parallel to one output.

Limit switch contacts can weld together and drives, curtains and the shutter actuator can be destroyed.

Observe the manufacturer's instructions and use cutoff relays, if necessary.

Fitting the device

- Fit the device by snapping it onto a mounting rail in acc. with DIN EN 60715. The screw terminals for connection of the motors should be at the top



A KNX/EIB data rail is not required.



Observe the temperature range (-5 °C ...+45 °C) and ensure sufficient cooling, if necessary.

Connecting the power supply for the device electronics

- Connect the bus (standard bus terminal) and the mains voltage as shown in the connection diagram .

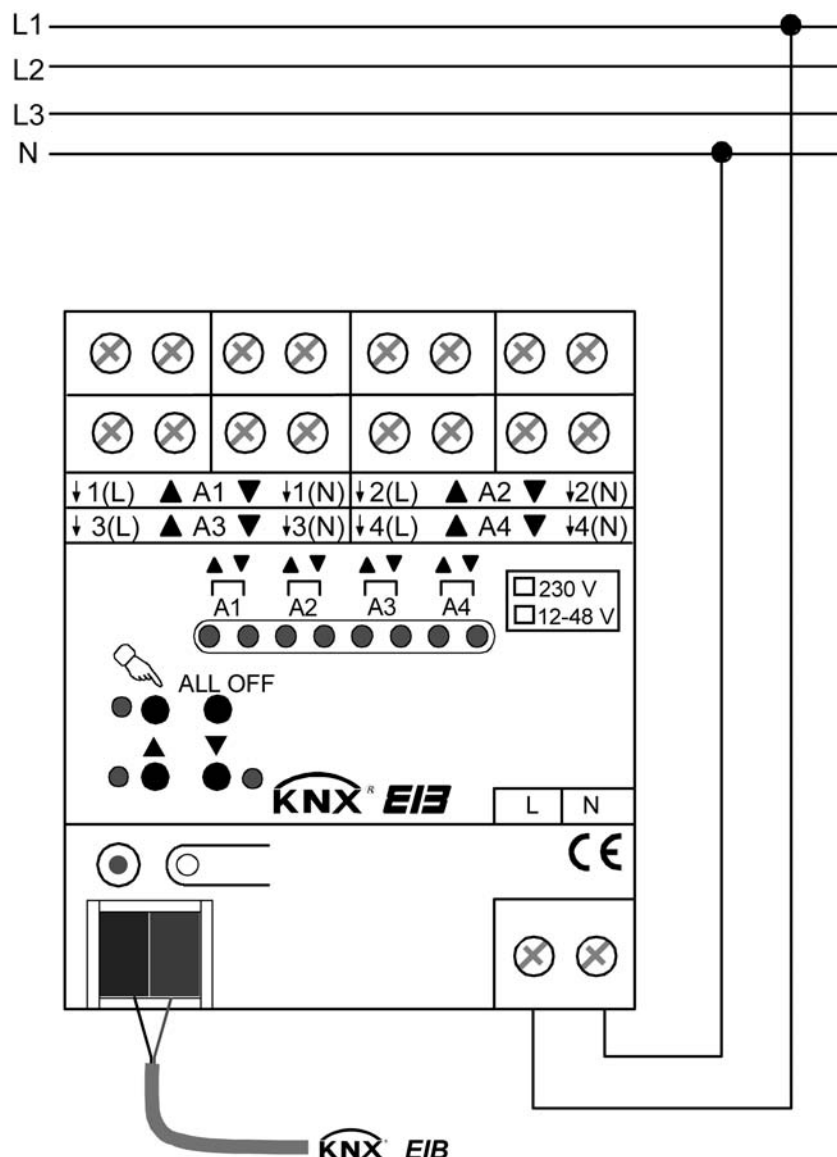

Figure 4: Electrical connection of mains voltage

- i** The connection diagram shows an example for connection of the power supply to the shutter actuator 2/4-channel REG.
- i** The device can be used with different phase conductors (L1, L2, L3).
- i** For actuation of the outputs – even in manual control mode – the mains supply must be on. The power supply for the device electronics (BCU with application program) is drawn from the bus voltage or from the mains voltage.
- i** The connection of the drives depends on the type of supply (230 V AC or 12 – 48 V DC) and on the automatic end position detection and is described on the following pages.

Connecting the device for 230 V drives (without automatic end position detection)

Without the automatic end position detection, the travelling times of the different blinds are programmed in the ETS independent of one another. After commissioning, the preset times can be changed only by reprogramming of the parameters.

The shutter actuator must be set in the ETS to 230 V operation.

- Connect the drives as shown in the wiring example (Figure 5).
- Tick the box "230 V" on the device label.

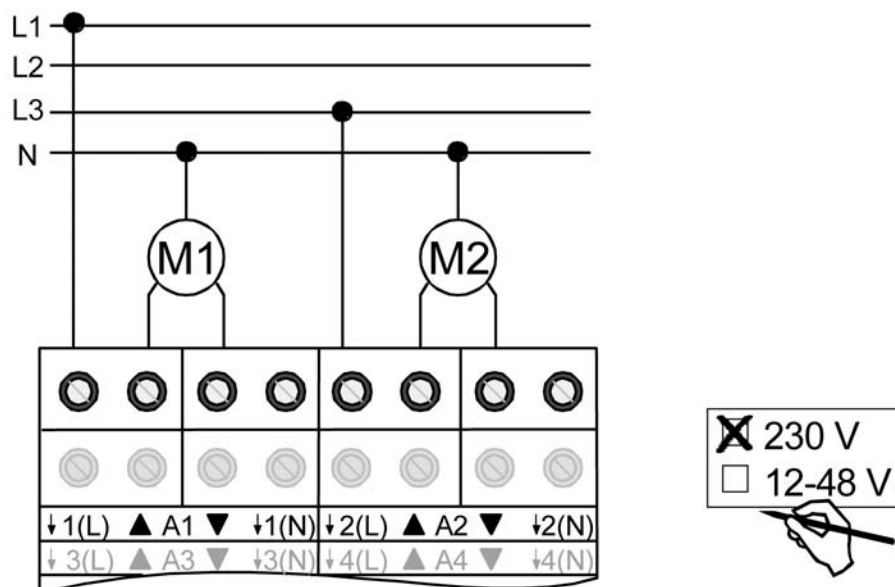

Figure 5: Electrical connection for 230 V drives

- i** Observe the admissible load ratings (cf. 'Technical data').
- i** The device can be used with different phase conductors (L1, L2, L3).
- i** In the type of supply described (Figure 5), it is not absolutely necessary to connect the N conductor to the shutter actuator. If, however, drives with high-resistance travel direction inputs (e.g. drives with electronic limit switches) are connected, then it is necessary to also connect the N conductor to the corresponding terminal of the shutter actuator. The data of the drive manufacturer should be observed.
If the N conductor is connected and the affected output is energised for a long period without an interruption through retriggering, then this may cause unpermitted heating of the Venetian blind actuator. Observe maximum switch-on time (cf. "Technical data").
- i** The N terminals are used only for automatic end position detection and must not be used as N potential for other loads in the distribution.
- i** Venting louvres must be connected in such a way that they open in travel direction "UP - ▲" and close in travel direction "DOWN - ▼".

Connecting the device to 230 V drive motors (with automatic end position detection)

If programmed and connected accordingly, the Venetian blind actuator auto-detects the travelling time of a connected output and stores it. In drives with mechanical limit switches, the actuator measures the voltage against the N conductor (connected to the device) in order to detect the end positions. In operation, the Venetian blind actuator can adapt itself to changes in the travelling times of the drives (e.g. caused by ageing of the motors).

The shutter actuator must be set in the ETS to 230 V operation.

The automatic end position detection must have been activated in the ETS for the output concerned.

Only 230 V AC drives with mechanical limit switches may be connected to the device.

Connect only one drive to each output.

The blinds controlled by the device must not be blocked.

- Connect the drives as shown in the wiring example (Figure 6).
- Tick the box "230 V" on the device label.

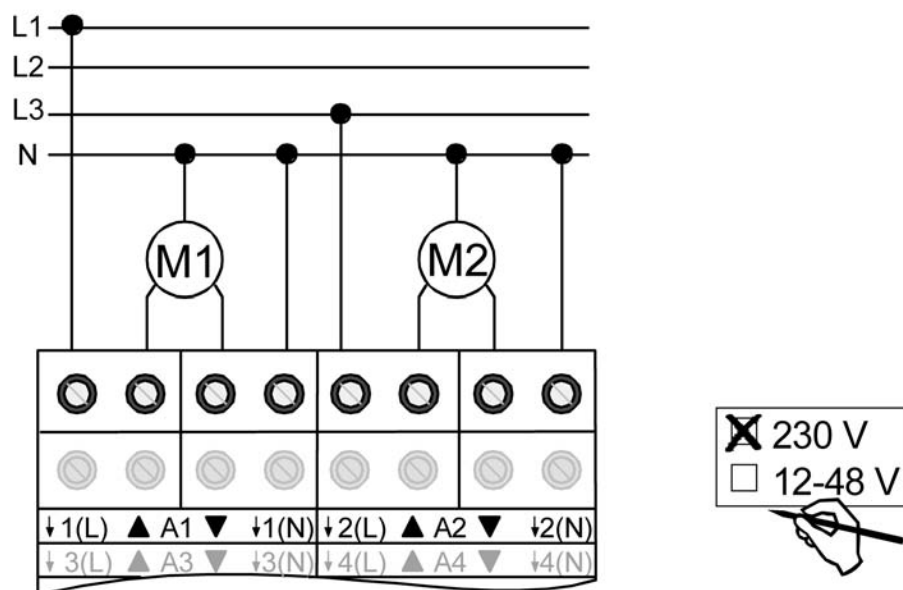

Figure 6: Electrical connection for 230 V drive motors for automatic limit position detection

- i** Observe the admissible load ratings (cf. 'Technical data'). The automatic end position detection cannot be used for 12...48 V DC drives or for drives with electronic limit switches and for drives connected to the outputs of the Venetian blind actuator via isolating relays.
- i** The device can be used with different phase conductors (L1, L2, L3).
- i** The neutral conductor of the respective motor must be connected to the N terminals of the device (observe existing ELCB wiring). The N terminals are used only for automatic end position detection and must not be used as N potential for other loads in the distribution. The N conductor connections of the individual outputs and of the mains connection terminal are internally not connected.
- i** If an output is energised without interruption for a prolonged time due to retriggering, the device may heat up excessively. Observe maximum switch-on time (cf. "Technical data").
- i** The automatic end position detection is performed during commissioning and the detected travelling time permanently stored.
- i** Venting louvres must be connected in such a way that they open in travel direction "UP - ▲" and close in travel direction "DOWN - ▼".

Connecting the device for 12 ... 48 V DC drive motors (without automatic end position detection)

The travelling times of the different blinds are programmed in the ETS independently of one another. After commissioning, the preset times can be changed only by reprogramming of the parameters. In operation of 12...48 V DC drives, the outputs of the Venetian blind actuator are combined into pairs (O1/O2, O3/O4, ...). Each output pair controls a single drive.

The Venetian blind actuator must be set in the ETS to 24 V DC operation.

- Connect the drives as shown in the wiring example (Figure 7).
- Tick the box "12...48 V" on the device label.

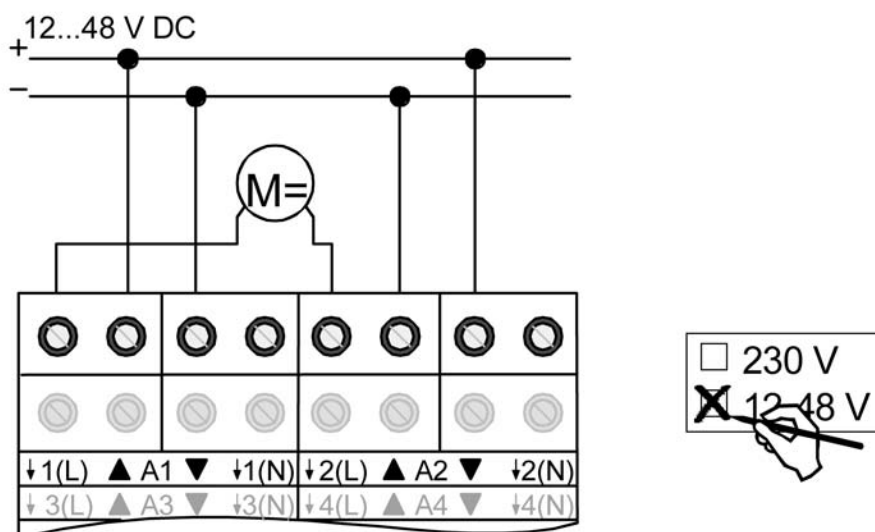

Figure 7: Electrical connection for 12 ... 48 V drives

- i** Observe the admissible load ratings (cf. 'Technical data').
- i** In 12...48 V DC operation, the outputs of the Venetian blind actuator are combined into channel pairs even for manual control. The status LEDs always indicate the relay states of the paired output.
- i** Venting louvres must be connected in such a way that they open in travel direction "UP - ▲" and close in travel direction "DOWN - ▼".

Installing / removing the protective cap

To protect the bus lines against hazardous voltages, especially in the area of the connecting terminals, a protective cap can be installed.

The cap is installed with the bus terminal in place and the connected bus line led out at the rear.

- To install the cap: slide the cap over the bus connecting terminal until you feel it engage (Figure 8).
- To remove the cap: Remove the cap by pressing the sides slightly and by pulling it out to the front (Figure 8).

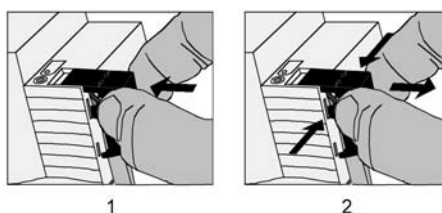

Figure 8: Installing / removing the protective cap for the bus connection

2.4 Commissioning

After installation of the actuator and connection of the bus line, the power supply and of all electrical drives, the device can be put into operation. The following procedure is generally recommended...



DANGER!

Electrical shock when live parts are touched.

Electrical shocks can be fatal.

Before working on the device, disconnect the power supply and cover up live parts in the working environment.

Measuring the travelling times (only without automatic end position detection)

For the purpose of positioning blinds, shutters and awnings or for adjusting the opening angle of venting louvers, the actuator needs accurate information about the maximum travelling time.

Switch on the mains supply.

- If not yet done, move the blind/shutter into the upper end position (open venting louver completely).
The upper limit-stop position is reached (venting louver opened).
- Start the measuring time and move the blind/shutter by manual control into the lower end position (close the venting louver completely).
- Stop the time measurement when the lower limit (when the completely closed) position is reached.
- Enter the measured value in the ETS (cf. "software description").

i It is recommended to perform several time measurements and to take the average of these values.

i The travelling time can also be determined after commissioning with the ETS (bus operation).

Measuring the travelling time extension (only without automatic end position detection)

When travelling upwards, blinds or shutters have a tendency of moving more slowly due to their own weight or to external physical influences (e.g. temperature, wind, etc.). The same applies to venting louvers where opening may take longer than closing.

For this reason, the blind actuator takes the parameterized travelling time extension into account when moving upwards or when opening the louvers (long-time operation / positioning). The extension is computed as a percentage of the travelling times in both directions.

The blind/shutter (venting louver) must be in the lower end position (venting louver closed).

Switch on the mains supply.

- If not yet done, move the blind/shutter into the lower end position (close venting louver completely)
Lower end position reached (venting louver closed).
- Start the measuring time and move the blind/shutter by manual control into the upper end position (open the venting louver completely).
- Stop the time measurement when the upper limit (the completely open) position is reached.
- Express the measured value as a percentage of the determined blind/shutter travelling time and enter the value in the ETS (cf. software description).

i It is recommended to perform several time measurements and to take the average of these values.

i The travelling time extension can also be determined after commissioning with the ETS (bus operation).

Storing the travelling times (only with automatic end position detection)

When the end position detection is active, the device can approach defined positions only if the travelling times for each output have been stored. An end position detection is to be performed whenever the device has been programmed with the ETS (download of the application or partial programming of parameters). The travelling times should be programmed in undisturbed conditions (no control operations, no wind, no snow and no obstacles).

Only for 230 V drives with mechanical limit switches.

The automatic end position detection must have been activated in the ETS (cf. "software description").

The N conductors for the outputs concerned must be connected to the actuator.

During the period of detection of the limit positions, the mains voltage must be present without failures at the actuator and at the drives.

The power supply of the actuator must have been on uninterrupted for at least 20 seconds.

- If not yet done, move the blind/shutter into the upper end position (open venting louver completely). The upper limit-stop position is reached (venting louver opened).
- Move the blind/shutter (venting louver) by manual control or via the bus into the lower end position (close the venting louver completely).
Lower end position reached (venting louver closed).

- Move the blind/shutter into the upper end position (open venting louver completely).

The travelling time is now stored. If necessary, repeat the procedure for other outputs.

- i** The blind actuator stores the blind/shutter positions permanently (EEPROM).
- i** Without stored travelling times, the blind actuator generates an "Invalid position" message for each output which can also be transmitted to the bus, if parameterized. The evaluation of this message can be used as an indicator for a successful teaching procedure.
- i** In operation, the blind actuator regularly adapts itself to changes in the curtain travelling times (e.g. ageing of the drives). In case of deviations from the original value, the travelling time thus determined will be used temporarily for computing the positions and stored only in a volatile memory (RAM).
- i** In addition to the times programmed during the first commissioning after ETS programming, the user always has the possibility of re-teaching travelling times 'manually' thereafter. To do so, the user must activate the permanent manual control mode (cf. chapter "Operation") and move the blind/shutter without interruption from one end position into the other. Simple travel movements (from top to bottom or vice versa) are sufficient for programming a new travelling time which is then stored in an NV memory.
- i** In case of slatted blinds, the travelling time of the slats cannot be taught by automatic end position detection. In this case, the actuator always resorts to the value parameterized in the ETS. As the slat moving time is in a fixed proportion to the travelling time of the curtain, a correction of the travelling time of the curtain automatically entails a correction of the slat moving time.
- i** The maximum travelling time is basically limited to 20 minutes. If the process of learning a new travelling time is not terminated after 20 minutes (no limit position detected), the actuator will end the learning process by itself (stop). The minimum travelling time is limited to 1 second.
- i** If the actuator was not in a position to learn a correct travel time (e.g. teaching runs longer than 20 minutes, no end position detection after ETS programming or abortion of travel before reaching an end position), the travelling time is not valid. In this case, the output concerned cannot approach fixed positions. If position values are nevertheless transmitted or activated via the bus (e.g. sun protection), the actuator translates all values between 0...49% (0...127) into an upward travel and all position values between 50% ...100% (128...255) into a downward travel. The travelling time corresponds in this case to the maximum travelling time (20 minutes).

Measuring the slat moving time (only for blinds without or with automatic end position detection)

In the case of blinds with slats, the slat moving time is for technical reasons part of the overall travelling time of the blinds/shutters. The slat moving time is the time required for a movement between the slat positions "closed – 100 %" and "open – 0 %". In order to compute the opening angle of the slats, the actuator needs an information about the slat moving time.

In case of slatted blinds, the travelling time of the slats cannot be taught by automatic end position detection. For this reason, the slat moving time must always be measured 'manually'.

The slats must be completely closed (as in case of downward travel of the blind).

Switch on the mains supply.

- Start the measuring time and open the slats completely by manual control (as in case of upward travel of the blind).
 - Take the measuring time when the completely open position is reached.
 - Enter the measured value in the ETS (cf. "software description").
- i** It is recommended to perform several time measurements and to take the average of these values.
- i** The slat-moving time can also be determined after commissioning with the ETS (bus operation).

Commissioning with the ETS

- Switch on bus voltage.
Check: the red programming LED must light up when the programming button is pressed.
 - Download the physical address and the application data with the ETS.
- i** When the mains supply is on, the outputs of the actuator can be switched manually even if there is no bus voltage or if the actuator is not yet programmed. Due to this feature, the drives connected to the individual outputs can be checked for proper functioning already during site operation.

Performing a reference travel (optional)

The blind actuator can approach predefined blind/shutter or louver positions only if the current positions are known. For this purpose, each output must be given the opportunity to synchronize itself whenever the supply voltage is switched on or after every ETS programming run (physical address, application program, partial download). The synchronization is performed by means of the reference travel.

Switch on the mains supply.

- If not yet done, move the blinds/shutters to the upper end position (open venting louver completely).
 - Wait until the output relay has switched off (not only the limit switch of the drive).
The reference travel is terminated.
- i** The blind actuator stores the blind/shutter, slat or louver positions temporarily. After each supply voltage failure (failure of the bus voltage and of the mains voltage) or after programming with the ETS, the actuator therefore automatically performs a reference travel for each output before a new position can be approached.
- i** After bus voltage return, the blind actuator generates an "invalid position" message for each output which can also be transmitted to the bus, if so parameterized. The message is cancelled (inverted message value) as soon as a reference travel can be performed. In case of automatic end position detection, a travelling time must have been learnt beforehand.

2.5 Operation

All outputs of the blind actuator can also be operated manually. The keypad with 4 function keys and 3 status LEDs on the front panel of the device can be used for setting the following modes of operation...

- bus control: operation from touch sensors or other bus devices
- Temporary manual control: manual control locally with keypad, automatic return to bus control,
- Permanent manual control: local manual control with keypad.

- i** The operating modes can be enabled or disabled by parameter settings in the ETS.
- i** When manual control is active, the outputs cannot be controlled via the bus.
- i** Manual control is possible only while the actuator is supplied with power from the mains. The manual control mode ends in case of bus voltage return or mains voltage failure.
- i** Manual control in the bus mode can be disabled by a telegram. The manual mode is terminated on activation of the disabling function.
- i** Further details concerning the manual mode, especially with respect to the possible parameter settings and the interaction with other functions of the blind actuator can be found in chapter "Software description" of the present documentation.

Controls and indicators for manual control

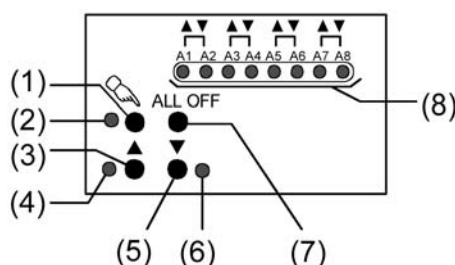

Figure 9: Controls and indicators for manual control on the front panel of the device.

- (1) Key Activation / deactivation of manual control
- (2) LED : indicates permanent manual control.
- (3) Key : Sustained press: upward travel output (long-time operation) / brief press: output stop.
- (4) Status LED : indicates an active travel movement in the manual mode (up / open).
- (5) Key : Sustained press: downward travel output (long-time operation)/ brief press: output stop.
- (6) Status LED : indicates an active travel movement in the manual mode (down / close).
- (7) Key ALL OFF stop all drives (only in permanent manual control).
- (8) Status LEDs : indicate the state of the individual outputs. One of the LEDs is lit up during an active travel movement in the corresponding direction initiated by bus or by manual control. One of the LEDs flashes when the corresponding output has been selected in manual control. One of the LEDs flashes fast when the corresponding output has been disabled during manual control.

Priorities

The blind actuator distinguishes between different functions that can be active at an output. In order to prevent conflicting output states, each available function has a certain priority. The function with the higher priority overrides the function with the lower priority.

- 1st priority: manual control (highest priority),
- 2nd priority: forced position,
- 3rd priority: safety function(s),

Priority levels 4 and 5 can be parameterized in the ETS. The options are then

- 4th priority: sun protection function
- 5th priority: direct operation via the bus (short-time/long-time operation, positioning, scenes, central function),

or...



- 4th priority: direct operation via the bus (short-time/long-time operation, positioning, scenes, central function),
- 5th priority: sun protection function

or...

- 4th priority: sun protection function and direct operation via the bus (short-time/long-time operation, positioning, scenes, central function).

Activating the temporary manual control

Manual control is enabled in the ETS.

- Press the  key briefly (< 1 s).
The two status LEDs of A1 are flashing (LED  remains off)
- i** In 12...48 V DC operation the LEDs of the output pair A1/A2 are flashing.
- i** After 5 s without a key-press, the actuator returns automatically to bus operation.



Deactivating temporary manual control

Temporary manual control was activated.

- No key-press for 5 s
- or -
- Select all outputs one after another by a brief press of the key. Thereafter, press the key once again.
- or -
- Switch the mains power supply off or reset the bus (bus voltage return). Temporary manual control is terminated. The Status LEDs A1...max. A8 display the status according to bus operation when mains voltage is switched on.
- i** The state set via manual control is not changed when temporary manual control is switched off. If, however, a function with a priority higher than that of the direct operation (e.g. forced position or safety function) has been activated via the bus before or during manual control, the actuator executes the function with the higher priority for the outputs concerned.

Activating permanent manual control

Manual control is enabled in the ETS. Bus operation or temporary manual control is active.

- Press the  key for at least 5 s.
The status LED  is illuminated. The two status LEDs of A1 are flashing. Permanent manual control is active:
- i** In 12...48 V DC operation the LEDs of the output pair A1/A2 are flashing.

Deactivating permanent manual control

Permanent manual control is active.

- Press the  key for at least 5 s.
- or -

- Select all outputs one after another by a brief press of the key. Thereafter, press the key once again.
- or -
- Switch the mains power supply off or reset the bus (bus voltage return). The status LED goes out. The Status LEDs A1...max. A8 display the status according to bus operation when mains voltage is switched on.
- i** Depending on the configuration of the actuator in the ETS, the outputs will be set to the state last adjusted in the manual mode or to the state internally tracked (direct operation, forced position, safety or sun protection position) when the permanent manual mode is shut off.

Controlling an output manually

Manual control (permanent or temporary) is activated.

- Select the desired output: Press the  key briefly (if necessary, repeatedly).
The Status LEDs of the selected output A1...max. A8 flash. If the selected output is active controlling a travel movement, the "▲" or "▼" status LEDs on the keypad are lit up additionally.
- Operate the output by pressing the ▲ button or ▼ button.
Short: Stop drive.
Long: Move drive up/down (long time operation) or open/close venting louvre.
The selected drive motor executes the corresponding commands immediately.
- i** In 12...48 V DC operation the LEDs of an output pair are always flashing when the output is selected.

Shutting off all outputs (stopping all drives)

Permanent manual control is active:

- Press the ALL OFF key
All outputs are shut off immediately (stop). The outputs are not locked. Individual activation is again possible after shutoff.
- i** The "ALL-OFF" function is not available in temporary manual control.

Disabling bus control of individual outputs manually

Permanent manual control is active:

Disabling of the bus control mode must have been enabled in the ETS.

- Select the output: Press the  key briefly (if necessary, repeatedly).
The Status LEDs of the selected output A1...max. A8 flash. If the selected output is active controlling a drive movement, the "▲" or "▼" status LEDs on the keypad are lit up additionally.
- Press the ▲ and the ▼ key simultaneously for at least 5 s.
The appropriate output is locked (control via the bus not possible). The Status LEDs of the selected output A1...max. A8 flash rapidly.
- i** To unlock, proceed in the same way.
- i** In 12...48 V DC operation the LEDs of an output pair are always flashing when the output is selected.
- i** An output that has been disabled in manual control can thereafter only be operated in permanent manual control.

3 Technical data

General

Mark of approval	KNX / EIB / VDE
Ambient temperature	-5 ... +45 °C
Storage/transport temperature	-25 ... +70 °C (Storage above +45 °C reduces the lifetime.)
Installation position	as desired (preferably top output terminals)
Minimum distances	none
Fixing type	Snapping onto top hat rails in closed housing (e.g. small distribution board, etc.)

Terminals for mains supply and outputs

Connection mode	Screw terminal
Single stranded	0.5 ... 4 mm ²
Finely stranded without conductor sleeve	0.35 ... 4 mm ²
Finely stranded with conductor sleeve	0.14 ... 2.5 mm ²
Connection torque	max. 0.8 Nm

KNX/EIB supply

KNX medium	TP 1
Commissioning mode	S-mode
Rated voltage KNX	DC 21 ... 32 V SELV
Power consumption KNX	typical 150 mW
Connection mode KNX	Standard terminal

External supply

Rated voltage	AC 230 / 240 V ~
Mains frequency	50 / 60 Hz
Power consumption	max. 5.6 VA
Power loss	
Order-No. 2152 00	max. 4.5W
Order-No. 1039 00	max. 4.5W
Order-No. 2161 00	max. 6W

Outputs

Contact type	μ contact, monostable
Mains frequency	50 / 60 Hz
Switching voltage	AC 250 V ~
Switching voltage DC	DC 12 ... 48 V
Switching current AC 250 V	AC 6 A
Contact rating DC 12/24 V	6 A
Switching current DC 48 V	3 A
Minimum switching current AC	100 mA
Minimum DC switching current	100 mA
Blind/shutter travelling time	max. 20 min
Duty cycle	max. 50% (cycle time ≤ 40 min)

4 Software description

4.1 Software specification

ETS search paths:	- shutter / shutter / Shutter/blind actuator 2fold 230 V AC / 1fold 12-48 V DC DRA
	- shutter / shutter / Shutter/blind actuator 4fold 230 V AC / 2fold 12-48 V DC DRA
	- shutter / shutter / Shutter/blind actuator 8fold 230 V AC / 4fold 12-48 V DC DRA
BAU used:	TPUART + μ C
KNX/EIB type class:	3b device with cert. Physical layer + stack
Configuration:	S mode standard
PEI type:	"00" _{Hex} / "0" _{Dec}
PEI connector:	No connector

Available applications for "Venetian blind actuator 1/2-channel REG"

No.	Short description	Name	Version	from mask version
1	Multi-functional Venetian blind application with separately configurable travelling times; alternatively automatic end position detection for 230 V drives with mechanical limit switches, expanded feedback functions, assignments to up to 5 different safety functions and a sun protection function adapted to the highest requirements. Also allows inclusion in scenes or forced movements. Centralised control of all outputs is also possible. Moreover, the preferred states of the relays in case of bus voltage failure or bus / mains voltage return and after ETS programming can be preset separately.	shutter/blind 20C401	0.1 for ETS 2 and ETS 3.0a...c	705
2	Multi-functional Venetian blind application with separately configurable travelling times; alternatively automatic end position detection for 230 V drives with mechanical limit switches, expanded feedback functions, assignments to up to 5 different safety functions and a sun protection function adapted to the highest requirements. Also allows inclusion in scenes or forced movements. Centralised control of all outputs is also possible. Moreover, the preferred states of the relays in case of bus voltage failure or bus / mains voltage return and after ETS programming can be preset separately.	shutter/blind 20C411	1.1 for ETS3.0 Version d onwards	705

Available applications for "Venetian blind actuator 2/4-channel REG"

No.	Short description	Name	Version	from mask version
1	Multi-functional Venetian blind application with separately configurable travelling times; alternatively automatic end position detection for 230 V drives with mechanical limit switches, expanded feedback functions, assignments to up to 5 different safety functions and a sun protection function adapted to the highest requirements. Also allows inclusion in scenes or forced movements. Centralised control of all outputs is also possible. Moreover, the preferred states of the relays in case of bus voltage failure or bus / mains voltage return and after ETS programming can be preset separately.	shutter/blind 20A802	0.2 for ETS 2 and ETS 3.0a...c	705
2	Multi-functional Venetian blind application with separately configurable travelling times; alternatively automatic end position detection for 230 V drives with mechanical limit switches, expanded feedback functions, assignments to up to 5 different safety functions and a sun protection function adapted to the highest requirements. Also allows inclusion in scenes or forced movements. Centralised control of all outputs is also possible. Moreover, the preferred states of the relays in case of bus voltage failure or bus / mains voltage return and after ETS programming can be preset separately.	shutter/blind 20A812	1.2 for ETS3.0 Version d onwards	705

Available applications for "Venetian blind actuator 4/8-channel REG"

No.	Short description	Name	Version	from mask version
-----	-------------------	------	---------	-------------------

- | | | | | |
|---|---|-------------------------|---|-----|
| 1 | Multi-functional Venetian blind application with separately configurable travelling times; alternatively automatic end position detection for 230 V drives with mechanical limit switches, expanded feedback functions, assignments to up to 5 different safety functions and a sun protection function adapted to the highest requirements. Centralised control of all outputs is also possible. Moreover, the preferred states of the relays in case of bus voltage failure or bus / mains voltage return and after ETS programming can be preset separately.
No inclusion in scenes or forced movements. | shutter/blind
20AD01 | 0.1
for ETS 2
and ETS
3.0a...c | 705 |
| 2 | Multi-functional Venetian blind application with separately configurable travelling times; alternatively automatic end position detection for 230 V drives with mechanical limit switches, expanded feedback functions, assignments to up to 5 different safety functions and a sun protection function adapted to the highest requirements. Integration into scenes or forced positions also available. Centralised control of all outputs is also possible. Moreover, the preferred states of the relays in case of bus voltage failure or bus / mains voltage return and after ETS programming can be preset separately. | shutter/blind
20AD11 | 1.1
for ETS3.0
Version d
onwards | 705 |

4.2 Software "Venetian blind"

4.2.1 Scope of functions

General

- Venetian blind actuator, 1/2-channel REG: 2-channel operation for direction connection of two 230 V AC drive motors. Alternatively, the Venetian blind actuator can be configured to 1-channel operation for direct control of a 12...48 V DC drive.
Venetian blind actuator 2/4-channel REG: 4-channel operation for direct connection of four 230 V AC drive motors. Alternatively, the Venetian blind actuator can be configured to 2-channel operation for direct control of two 12...48 V DC drives.
Venetian blind actuator 4/8-channel REG: 8-channel operation for direct connection of eight 230 V AC drive motors. Alternatively, the Venetian blind actuator can be configured to 4-channel operation for direct control of four 12...48 V DC drives.
Both actuators: mixed operation of 230 V and 12...48 V DC motors is not possible.
- Behaviour in case of bus voltage failure and bus voltage return as well as after ETS programming presettable for each output.
- Central control of all Venetian blind outputs via 1-bit long-time operation telegram possible.
- Active feedback telegrams can be globally delayed after bus voltage return.
- Manual control of outputs independent of the bus (for instance, building site operation) with LED status indicators.

Channel-oriented functions

- Each output offers the full scope of functions without any restrictions. All channel-oriented functions can be parameterized separately for each output. This feature permits independent and multi-functional control of the blind outputs.
- Mode of operation parameterizable: control of blinds with slats, shutters or venting louvers.
- Separately parameterizable blind/shutter travelling times with travelling time extension for moves into the upper end position.
- Optionally with automatic end position detection (automatic determination of the blind/shutter travelling time) for 230 V drive motors with mechanical limit switches.
- For blinds with slats, a slat-moving time can be independently parameterized
- Travel direction change-over time and the times for short-time and long-time operation (step, move) presettable.
- Blind/shutter or slat position feedback telegram (only with bus control). In addition, an invalid blind/shutter position or an invalid travel movement can be reported back. Active (transmitting after changes) or passive (object readout) feedback functions.
- Assigning of outputs to up to 5 different safety functions (3 wind alarms, 1 rain alarm, 1 frost alarm) optionally with cyclical monitoring. The safety functions (objects, cycle times, priority) are programmed device-oriented and in common for all outputs. The assignment of individual outputs to the safety functions and the safety measures can be parameterized for each channel.
- An extensive sun protection function with fixed and variable blind/shutter or slat positions at the beginning and at the end of the function can be activated separately for each output. Dynamic slat offset for slatted blinds included. Also with enlarged sun protection feature for integration into sophisticated shading control programs (operated via separate automatic and disabling object). Optionally also with automatic heating/cooling and presence detection function.
- Forced-position function can be implemented for each blind output (forced positions available with 4/8-channel device variant only with ETS3.0d and higher).
- Integration in scenes possible: up to eight internal scenes can be parameterized for each output (when using the 4/8-channel device variant the scene function is only available with ETS3.0d and higher).

4.2.2 Software information

ETS project design and start-up

For configuration and commissioning of this device, we recommended using ETS3.0d. Advantages with regard to downloading (significantly shorter loading times) and parameter programming can be expected only if this ETS patch version or later versions are used. The advantages are gained through the use of the new mask version 7.5 and the parameter presentation of ETS3.

The product database required for the ETS3.0d is offered in the *.VD4 format. The appropriate application program has the version number "1.x".

For the ETS2 and older versions of the ETS3 a separate product database in the *.VD2 format is available. The application program for these ETS versions is version number "0.x".

With regard to the scope of configuration functions described in this documentation, the two application programs differ for the Venetian blind actuator, 4/8-channel. In the version "0.x"there are no scene and forced position functions.

When older ETS versions are updated to the level of version ETS3.0d or to that of later versions, an additional tool in the form of an ETS3 add-in is available. This tool is able to convert older product databases with the application version "0.x" – for example from existing ETS2 projects – into the new application format (Version "1.x"). This way you can make use of the advantages of the ETS3.0d application easily and without changing the configuration. The ETS3 add-in can be obtained separately and free of charge from the manufacturer.

Safe-state mode

If the device does not work properly - for instance as a result of errors in the project design or during commissioning - the execution of the loaded application program can be halted by activating the safe-state mode. The safe-state mode does not permit controlling the outputs via the bus and by hand. The actuator remains passive since the application program is not being executed (state-of-execution: terminated). Only the system software is still functional so that the ETS diagnosis functions and also programming of the device continue to be possible.

Activating the safe-state mode

- Shut off the bus and the mains voltage supply.
- Press and hold down the programming button.
- Switch on the bus or mains voltage. Release the programming button only after the programming LED starts flashing slowly.

The safe-state mode is activated. With a new brief press of the programming button, the programming mode can be switched on and off as usual also in the safe-state mode. The programming LED will nevertheless continue to flash independently of the programming mode as long as the safe-state mode is active.

- i** The safe-state mode can be terminated by switching off the supply voltage (bus or mains) or by programming with the ETS.

Unloading the application program

The application program can be unloaded with the ETS. In this case, manual control as part of the application program is not available either.

4.2.3 Object table

Number of communication objects:	1/2-channel: 46 (max. object number 55 - gaps in between)
	2/4-channel: 84 (max. object number 107 - gaps in between)
	4/8-channel: 160 (max. object number 211 - gaps in between)
Number of addresses (max):	254
Number of assignments (max):	255
Dynamic table management	No
Maximum table length	255

Channel-independent objects

Function: Manual operation

Object	Function	Name	Type	DPT	Flag
 ⁰	Disabling	Manual operation	1-bit	1.003	C, W, -, (R) ₁

Description 1-bit object for disabling the buttons for manual control on the device. The polarity can be configured.

Function: Manual operation

Object	Function	Name	Type	DPT	Flag
 ¹	Status	Manual operation	1-bit	1.002	C, -, T, (R) ¹

Description 1-bit object for manual control status transmission. The object is "0", when manual control is deactivated (bus control). The object is "1", when manual control is being activated. You can configure whether the temporary or the permanent manual control will be indicated as status information or not.

Function: Venetian blind central function

Object	Function	Name	Type	DPT	Flag
 ²	Central movement	All Venetian blind outputs	1-bit	1.008	C, W, -, (R) ₁

Description 1-bit object for central actuation (long-time movement) of assigned Venetian blind outputs. The polarity can be configured.

1: Each communication object can be read out. For reading, the R-flag must be set.

Function: Safety function

Object	Function	Name	Type	DPT	Flag
 ³	Wind alarm 1	Safety	1-bit	1.005	C, W, -, (R) 1

Description 1-bit object for central activation or deactivation of the first wind alarm ("0" = wind alarm deactivated / "1" = wind alarm activated).

Function: Safety function

Object	Function	Name	Type	DPT	Flag
 ⁴	Wind alarm 2	Safety	1-bit	1.005	C, W, -, (R) 1

Description 1-bit object for central activation or deactivation of the second wind alarm ("0" = wind alarm deactivated / "1" = wind alarm activated).

Function: Safety function

Object	Function	Name	Type	DPT	Flag
 ⁵	Wind alarm 3	Safety	1-bit	1.005	C, W, -, (R) 1

Description 1-bit object for central activation or deactivation of the third wind alarm ("0" = wind alarm deactivated / "1" = wind alarm activated).

Function: Safety function

Object	Function	Name	Type	DPT	Flag
 ⁶	Rain alarm	Safety	1-bit	1.005	C, W, -, (R) 1

Description 1-bit object for central activation or deactivation of the rain alarm ("0" = rain alarm deactivated / "1" = rain alarm activated).

Function: Safety function

Object	Function	Name	Type	DPT	Flag
 ⁷	Frost alarm	Safety	1-bit	1.005	C, W, -, (R) 1

Description 1-bit object for central activation or deactivation of the frost alarm ("0" = frost alarm deactivated / "1" = frost alarm activated).

1: Each communication object can be read out. For reading, the R-flag must be set.

Channel-oriented objects:

Function: Long time operation

Object	Function	Name	Type	DPT	Flag
<input type="checkbox"/> ← 10, 36, 62, 88, 114, 140, 166, 192	Long time operation	Output 1 - 8 ¹	1-bit	1.008	C, W, -, (R) 2

Description 1-bit object for activation of long time operation

Function: Short time operation

Object	Function	Name	Type	DPT	Flag
<input type="checkbox"/> ← 11, 37, 63, 89, 115, 141, 167, 193	Short time operation	Output 1 - 8 ¹	1-bit	1.007	C, W, -, (R) 2

Description 1-bit object for activation of short time operation or for stopping a drive movement.

 Function: Forced position³

Object	Function	Name	Type	DPT	Flag
<input type="checkbox"/> ← 12, 38, 64, 90, 116, 142, 168, 194	Forced position	Output 1 - 8 ¹	2-bit	2.008	C, W, -, (R) 2

Description 2-bit object for forced control of an output. The object state after bus voltage return can be predefined by means of a parameter.

 Function: Scene function³

Object	Function	Name	Type	DPT	Flag
<input type="checkbox"/> ← 13, 39, 65, 91, 117, 143, 169, 195	Scene extension	Output 1 - 8 ¹	1 byte	18.001	C, W, -, (R) 2

Description 1-byte object for recalling scenes or for storing new scene values.

1: The object designations are dependent of the selected channel definition. In 12...48 V DC operation, outputs 1/2, 3/4, ... are combined into channel pairs. Moreover the number of outputs depends on the device version.

2: Each communication object can be read out. For reading, the R-flag must be set.

3: This object is not present with the Venetian blind actuator 4/8-channel in the application version "0.1" (use for ETS2 and ETS3.0a...c).

Function: Sun protection function

Object	Function	Name	Type	DPT	Flag
 15, 41, 67, 93, 119, 145, 171, 197	Automatic mode	Output 1 - 8 ¹	1-bit	1.003	C, W, -, (R) ₂

Description 1-bit object for activation or deactivation of the automatic sun protection in the extended sun protection mode ("1" = automatic mode activated / "0" = automatic mode deactivated). The object is only visible, if the automatic sun protection is to be tracked immediately when the state of the automatic object changes (parameter setting).

Function: Sun protection function

Object	Function	Name	Type	DPT	Flag
 16, 42, 68, 94, 120, 146, 172, 198	Automatic mode disable	Output 1 - 8 ¹	1-bit	1.003	C, W, -, (R) ₂

Description 1-bit object for disabling of the automatic sun protection in the extended sun protection mode. The polarity can be configured. The object is only visible, if the automatic sun protection is to be tracked immediately when the state of the automatic object changes (parameter setting).

Function: Sun protection function

Object	Function	Name	Type	DPT	Flag
 16, 42, 68, 94, 120, 146, 172, 198	Automatic mode	Output 1 - 8 ¹	1-bit	1.003	C, W, -, (R) ₂

Description 1-bit object for activation or deactivation of the automatic sun protection in the extended sun protection mode. The polarity can be configured. The object is only visible, if the automatic sun protection is to be tracked only when the state of the automatic object changes next time (parameter setting).

1: The object designations are dependent of the selected channel definition. In 12...48 V DC operation, outputs 1/2, 3/4, ... are combined into channel pairs. Moreover the number of outputs depends on the device version.

2: Each communication object can be read out. For reading, the R-flag must be set.

Function: Sun protection function

Object	Function	Name	Type	DPT	Flag
 17, 43, 69, 95, 121, 147, 173, 199	Direct operation disable	Output 1 - 8 ¹	1-bit	1.003	C, W, -, (R) ₂

Description 1-bit object for disabling direct operation in the extended sun protection mode (direct operation = Move / Step / Position / Scene / Central). The polarity can be configured.

Function: Sun protection function

Object	Function	Name	Type	DPT	Flag
 18, 44, 70, 96, 122, 148, 174, 200	Sunshine / shading facade	Output 1 - 8 ¹	1-bit	1.002	C, W, -, (R) ₂

Description 1-bit object for activation or deactivation of sun shading in the simple or extended sun protection mode (sun / no sun). The polarity can be configured.

Function: Sun protection function

Object	Function	Name	Type	DPT	Flag
 19, 45, 71, 97, 123, 149, 175, 201	Sunsh./shading position ³	Output 1 - 8 ¹	1 byte	5.001	C, W, -, (R) ₂

Description 1-byte object for presetting a variable position value (0...255) for the height of the Venetian blind or roller shutter height or the venting louver position when the sun protection is active.

1: The object designations are dependent of the selected channel definition. In 12...48 V DC operation, outputs 1/2, 3/4, ... are combined into channel pairs. Moreover the number of outputs depends on the device version.

2: Each communication object can be read out. For reading, the R-flag must be set.

3: The object designation varies with the type of blind (Venetian blind, roller shutter / awning, venting louver).

Function: Sun protection function

Object	Function	Name	Type	DPT	Flag
<input type="checkbox"/> ← 20, 46, 72, 98, 124, 150, 176, 202	Slat pos. Sunshine / shading	Output 1 - 8 ¹	1 byte	5.001	C, W, -, (R) ₂

Description 1-byte object for presetting a variable slat position value (0...255) when the sun protection is active.

Function: Sun protection function

Object	Function	Name	Type	DPT	Flag
<input type="checkbox"/> ← 21, 47, 73, 99, 125, 151, 177, 203	Sunshine slat position offset	Output 1 - 8 ¹	1 byte	6.001	C, W, -, (R) ₂

Description 1-byte object for presetting a slat position angle (- 100 % ... +100 % / smaller or larger position angles are treated as + or - 100 %) for 'manual' readjustment of the slat position during active sun protection.

Function: Sun protection function – automatic heating/cooling

Object	Function	Name	Type	DPT	Flag
<input type="checkbox"/> ← 22, 48, 74, 100, 126, 152, 178, 204	Heating/cooling presence	Output 1 - 8 ¹	1-bit	1.018	C, W, -, (R) ₂

Description 1-bit object for activation of the presence mode during automatic heating/cooling. The polarity can be configured. This object is generally linked with presence detectors.

1: The object designations are dependent of the selected channel definition. In 12...48 V DC operation, outputs 1/2, 3/4, ... are combined into channel pairs. Moreover the number of outputs depends on the device version.

2: Each communication object can be read out. For reading, the R-flag must be set.

Function: Sun protection function – automatic heating/cooling

Object	Function	Name	Type	DPT	Flag
 23, 49, 75, 101, 127, 153, 179, 205	Heating/cooling switchover	Output 1 - 8 ¹	1-bit	1.100	C, W, -, (R) ₂

Description 1-bit object for switching over between heating and cooling operation during automatic heating/cooling. The polarity can be configured. This object is generally linked with room temperature controllers (object "heating/cooling switchover").

Function: Position feedback

Object	Function	Name	Type	DPT	Flag
 24, 50, 76, 102, 128, 154, 180, 206	Position feedback ³	Output 1 - 8 ¹	1 byte	5.001	C, -, T, R ^{2,4}

Description 1-byte object for position feedback of the Venetian blind or roller shutter height or louver position (0...255).

Function: Position feedback

Object	Function	Name	Type	DPT	Flag
 25, 51, 77, 103, 129, 155, 181, 207	Slat position feedback	Output 1 - 8 ¹	1 byte	5.001	C, -, T, R ^{2,4}

Description 1-byte object for position feedback of the slat position (0...255) if one shutter is controlled.

1: The object designations are dependent of the selected channel definition. In 12...48 V DC operation, outputs 1/2, 3/4, ... are combined into channel pairs. Moreover the number of outputs depends on the device version.

2: Each communication object can be read out. For reading, the R-flag must be set.

3: The object designation varies with the type of blind (Venetian blind, roller shutter / awning, venting louver).

4: Depending on the configuration, feedback objects are either actively transmitting (T flag set) or passively readable (R flag set).

Function: Position feedback

Object	Function	Name	Type	DPT	Flag
 26, 52, 78, 104, 130, 156, 182, 208	Invalid position feedback	Output 1 - 8 ¹	1-bit	1.002	C, -, T, R ^{2,3}

Description 1-bit object for reporting back an invalid position of the Venetian blind or roller shutter height or louver position ("0" = position valid / "1" = position invalid).

Function: Drive movement feedback

Object	Function	Name	Type	DPT	Flag
 27, 53, 79, 105, 131, 157, 183, 209	Drive movement feedback	Output 1 - 8 ¹	1-bit	1.002	C, -, T, R ^{2,3}

Description 1-bit object for feedback of an active drive movement (output energised - up or down). ("0" = no drive movement / "1" = drive movement).

Function: Presetting the position

Object	Function	Name	Type	DPT	Flag
 28, 54, 80, 106, 132, 158, 184, 210	Position ⁴	Output 1 - 8 ¹	1 byte	5.001	C, W, -, (R) ²

Description 1-byte object for presetting a position value (0...255) for the height of the Venetian blind or roller shutter or the venting louver position in direct operation.

1: The object designations are dependent of the selected channel definition. In 12...48 V DC operation, outputs 1/2, 3/4, ... are combined into channel pairs. Moreover the number of outputs depends on the device version.

2: Each communication object can be read out. For reading, the R-flag must be set.

3: Depending on the configuration, feedback objects are either actively transmitting (T flag set) or passively readable (R flag set).

4: The object designation varies with the type of blind (Venetian blind, roller shutter / awning, venting louver).

Function: Presetting the position

Object	Function	Name	Type	DPT	Flag
 29, 55, 81, 107, 133, 159, 185, 211	Slat position	Output 1 - 8 ¹	1 byte	5.001	C, W, -, (R) ₂

Description 1-byte object for presetting a slat position value (0...255) in direct operation.

1: The object designations are dependent of the selected channel definition. In 12...48 V DC operation, outputs 1/2, 3/4, ... are combined into channel pairs. Moreover the number of outputs depends on the device version.

2: Each communication object can be read out. For reading, the R-flag must be set.

4.2.4 Functional description

4.2.4.1 Description of channel-independent functions

Channel definition

Depending on the device variant, the Venetian blind actuator can either be configured to 2-channel, 4-channel or 8-channel operation for direct connection of 230 V AC drive motors, or, alternatively, to 1-channel, 2-channel or 4-channel operation for direct control of 12...48 V DC drives.

Both actuators: mixed operation of 230 V and 12...48 V DC motors is not possible. The "Channel definition" parameter on the "General" parameter page specifies the number of channels.

Depending on this setting, all the channel-dependent parameters and objects are created in the ETS and made visible. In 12...48 V DC operation, the outputs 1/3, 3/4 ... are combined into output pairs. The names of the output objects and the parameter page change accordingly. The outputs are combined as described also in the manual control mode.

Delay after bus voltage return

To reduce telegram traffic on the bus line after bus voltage activation (bus reset), after connection of the device to the bus line or after programming with the ETS, it is possible to delay all actively transmitted feedback telegrams of the actuator. For this purpose, a channel-independent delay can be specified (parameter "Delay after bus voltage return" on parameter page "General"). Only after the configured time elapses are feedback telegrams for initialisation transmitted to the bus.

Which of the feedback telegrams is actually delayed and which is not can be specified for each output channel and for each feedback function separately.

- i** The delay has no effect on the behaviour of the outputs. Only the feedback telegrams are delayed. The outputs can also be activated during the delay after bus voltage return.
- i** A setting of "0" for the delay after bus voltage return deactivates the delaying function altogether. In this case, all feedback telegrams, if actively transmitted, will be transmitted to the bus without any delay.

Central function

The actuator offers the possibility of linking selected individual or all output channels with a 1-bit central communication object. The behaviour in case of activating an output via the central function is comparable to a central group address linked with all "Long time operation" objects. The outputs assigned to the central function are activated in accordance with the central object value received. If necessary, the polarity of the central telegram can be configured as inverted. The behaviour of the channels is identical with the 'normal' activation via the "Long-time operation" objects. In this case the central telegram has got the same priority so the command last received (long-time or central) will be executed .

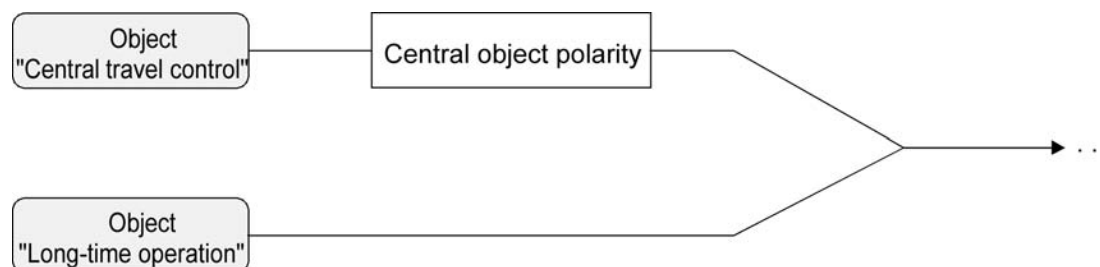

Figure 10: Function diagram "Central movement"

Enabling the central function

- Enable the central function on parameter page "General" by setting the "Central function ?" parameter to "Yes".

The "Central movement" communication object is visible.

Assigning outputs to the central function

Each output can be assigned independently to the central function.

The central function must have been enabled on parameter page "General". The assignment has otherwise no effect on the Venetian blind output.

- Set the "Assignment to central function" parameter on parameter page "Ax-Enabled functions" (x = number of output) to "Yes".

The appropriate output is assigned to the central function. It can be moved centrally.

- i** The blind, venting louvre or slat position newly set by the central function is tracked at the end of a travel movement in the feedback objects and also transmitted to the bus, if these are actively transmitting. It should be noted that the Venetian blind actuator can compute positions after application of the supply voltage only if a reference movement into the upper limit positions has been performed beforehand.
- i** The central function belongs to the set of 'direct operations' of an output. For this reason, the central function has the same priority compared with operation using the short time or long time objects, used to control the positioning objects or to recall scenes.
- i** After a bus voltage return or after programming with the ETS, the central function is always inactive (object value "0").

Manual control

All outputs of the blind actuator can also be operated manually. The keypad with 4 function keys and 3 status LEDs on the front panel of the device can be used for setting the following modes of operation...

- bus control: operation from touch sensors or other bus devices
- Temporary manual control: manual control locally with keypad, automatic return to bus control,
- Permanent manual control: local manual control with keypad.

The operation of the function keys, the control of the outputs and the status indication are described in detail in chapter "Operation".

The following paragraphs are to give a more detailed description of the parameterization, status feedback, disabling via bus control and the interactions with other functions of the blind actuator when the manual control mode is activated and deactivated.

Manual control is possible only while the blind actuator is supplied with power from the mains. The actuator is delivered with the manual control mode fully enabled. In this unprogrammed state, the individual outputs can be switched on and off also without bus voltage so that fast function checking of the connected drives (e.g. on the construction site) is possible.

After the first commissioning of the actuator with the ETS, the manual control mode can be separately enabled or disabled for different states of operation. Manual control can, for instance, be disabled during bus operation (bus voltage applied). Another option consists in the complete disabling of the manual control only in case of bus voltage failure. Manual control can therefore be completely disabled during bus operation, but also in case of bus failures only.

Enabling the manual control mode

Manual control for the different states of operation is enabled or disabled by means of the parameters "Manual control in case of bus voltage failure" and "Manual control during bus operation" on the "Manual control" parameter page.

- Set the parameter "Manual control in case of bus voltage failure" to "enabled".
Manual control is then basically enabled when the bus voltage is off. This setting corresponds to the setting of the actuator as delivered.
- Set the parameter "Manual control in case of bus voltage failure" to "disabled".
Manual control is completely disabled when the bus voltage is off. In this case, bus operation is not possible either so that the outputs of the actuator can no longer be actuated.

- i** In the configuration "Manual control in case of bus voltage failure = disabled", bus voltage failure will not terminate manual control if previously activated. The parameter configuration only has an effect if manual control is terminated first by key operation on the device. Manual control can then not be activated while the bus voltage is switched off.
- Set the parameter "Manual control during bus operation" to "enabled".
Manual control is then basically enabled when the bus voltage is on. The outputs of the actuator can be operated via the bus or manually. This setting corresponds to the setting of the actuator as delivered.
 - Set the parameter "Manual control during bus operation" to "disabled".
Manual control is completely disabled when the bus voltage is on. In this configuration, the actuator outputs can only be operated via the bus.
- i** Further parameters and communication objects of the manual control are visible only in the configuration "Manual control during bus operation = enabled". For this reason, the disabling function, the status message and bus control disabling can only be configured in the above parameter setting.

Presetting the behaviour at the beginning and at the end of manual control.

Manual control is divided into temporary and permanent manual control. Depending on these modes, the actuator behaves differently, especially at the end of the control mode. It should be noted that the operation via the bus, i.e. control of the outputs by direct operation (move / step / position / scene / central) or by the sun protection and safety functions is always disabled when the manual control is active. This means that the manual control mode has the highest priority.

Behaviour at the beginning of manual control:

The behaviour at the beginning of manual control is the same for both temporary and permanent manual control. When manual control is activated, all travel movements that were started beforehand by bus control will still be completed unless the travel movement in question is stopped by hand.

An active forced-position, safety and sun protection function can be overridden by manual control. These functions are reactivated after deactivation of the manual mode unless they have been cancelled in the meantime.

Behaviour at the end of manual control:

The behaviour at the end of manual control is different depending on whether it is temporary manual control or permanent manual control.

The temporary manual mode is shut off automatically when the last output has been addressed and when the select key is pressed once more. During a shutoff of the temporary manual control mode, the actuator goes back to 'normal' bus operation and does not change the state selected by manual control. If, however, a forced position, safety or sun protection function (independent of priority) has been activated via the bus before or during manual control, the actuator executes these functions of a higher priority again for the outputs concerned.

The permanent manual control mode is shut off, when the select key is pressed for more than 5 s. Depending on the parameterization of the actuator in the ETS, the outputs will be set to the state last adjusted in the manual mode or to the state internally tracked (direct operation, forced position, safety or sun protection position) when the permanent manual mode is shut off. The parameter "Behaviour at the end of permanent manual control during bus operation" defines the corresponding reaction.

- Set the parameter "Behaviour at the end of permanent manual control during bus operation" to "no change".
All telegrams received during an active permanent manual control mode for direct operation (long-time/short-time, positioning, central, scenes) will be rejected. After the end of the permanent manual control mode, the current state of all outputs remains unchanged. If, however, a forced position, safety or sun protection function (independent of priority) has been activated via the bus before or during manual control, the actuator executes these functions of a higher priority again for the outputs concerned.

- Set the parameter "Behaviour at the end of permanent manual control during bus operation" to "track outputs".

During an active permanent manual control all incoming telegrams (short-time telegrams – step/stop excepted) are internally tracked. At the end of the manual control mode, the outputs will be set to the tracked states or to the absolute positions last set before the permanent manual control mode. A long-time operation is not tracked, if the output is already in the corresponding end position.
- ❗ The behaviour at the end of the permanent manual control when the bus voltage is off (only manual control) is permanently set to "no change".
- ❗ The control operations triggered in the manual control mode will be transmitted via feedback objects to the bus, if enabled and actively transmitting.
- ❗ On return of bus voltage or after programming with the ETS an activated manual control mode will always be terminated. In this case, the parameterized or predefined behaviour at the end of manual control will not be executed. The actuator executes the parameterized behaviour on bus voltage return or after ETS programming instead.

Presetting a manual control disable

The manual control mode can be separately disabled via the bus, even if it is already active. As soon as a disabling telegram is received via the disabling object in case the disabling function is enabled, the actuator ends an activated manual control mode immediately and interlocks the function keys on the device panel. The telegram polarity of the disabling object is parameterizable.

The manual control mode during bus operation must be enabled.

- Set the parameter "Disabling function ?" on parameter page "Manual control" to "yes".

The disabling function of the manual control mode is enabled and the disabling object is visible.
- Select the desired telegram polarity in the "Disabling object polarity" parameter.
- ❗ If the polarity is "0 = disabled; 1 = enabled", the disabling function is immediately active on return of bus voltage or after an ETS programming operation (object value "0"). To activate the manual control in this case, an enable telegram "1" must first be sent to the disabling object.
- ❗ In case of bus voltage failure, disabling via the disabling object is always inactive (depending on parameterization, the manual control is then either enabled or completely disabled). After return of bus voltage a disabled state that was active before will be reactivated. The disabled state will be deactivated only after an enabling telegram has been received. In case of supply voltage failure (bus and mains voltage failure), a disable via the disabling object will be deactivated. An interruption of the mains supply alone has no effect on the disabled state of the manual control.
- ❗ When an active manual control is terminated by a disable, the actuator will also transmit a "Manual control inactive" status telegram to the bus, if the status messaging function is enabled.

Presetting the status message function for the manual control mode

The actuator can transmit a status message to the bus via a separate object, when the manual control mode is activated or deactivated. The status telegram can only be transmitted when the bus voltage is present. The polarity of the status telegram can be parameterized.

The manual control mode during bus operation must be enabled.

- Set the parameter "Transmit status ?" on the "Manual control" parameter page to "yes".

The status messaging function of the manual mode is enabled and the status object is visible.
- Specify in the parameter "Status object function and polarity" whether the status telegram is generally a "1" telegram whenever the manual control mode is activated or only in those cases where the permanent manual mode is activated.
- ❗ The status object is always "0", when the manual control mode is deactivated.

- i** The status will be actively transmitted to the bus ("0") only if a manual control that was activated during bus voltage failure is terminated by the return of the bus voltage. The status telegram is in this case transmitted without delay. After bus voltage return or after programming with the ETS, the value of the status object is " 0 " and can also be read out.
- i** When an active manual control is terminated by a disable, the actuator will also transmit a "Manual control inactive" status telegram to the bus.

Setting disabling of the bus control

Individual outputs can be disabled locally, so that the outputs concerned can no longer be activated via the bus. Disabling of the bus operation is initiated by means of local operation in permanent manual control, and indicated by quick flashing of the status LEDs of the outputs concerned. The disabled outputs can then be activated exclusively in permanent manual control.

The manual control mode during bus operation must be enabled.

- Set the parameter "Disable bus control of individual outputs" on the "Manual control" page to "yes".

The function for disabling the bus control is enabled and can be activated locally. As an alternative, setting this parameter can be set to "no" to prevent activation of disabling of the bus control in permanent manual control.
- i** The disabling initiated locally has the highest priority. Thus other functions of the actuator that can be activated via the bus (e.g. forced position or safety function) are overridden. Depending on the parameterization of the actuator in the ETS, the outputs will be set to the state last adjusted in the manual mode or to the state internally tracked (direct operation, forced position, safety or sun protection position) when the permanent manual mode is shut off.
- i** Locally activated disabling of the bus control is not reset in case of bus voltage failure or return. Failure of only the mains voltage also does not reset the disabling. A failure of the supply voltage (bus voltage and mains voltage failure) deactivates the disabling of the bus control.

Safety functions:

The blind actuator can handle up to five different safety functions. Each safety function has a communication object of its own so that the functions can be activated or deactivated independently of one another.

Three different wind alarms are available. These alarms can be used, for instance, to protect blinds or awnings on several building facades from wind and gusts. In addition or as an alternative, a rain alarm, for instance, as a protection for awnings, and a frost alarm as a protection against mechanical damage to lowered blinds in low temperatures can be activated and used. The telegram polarity of the safety objects is fixed: "0" = no alarm / "1" = alarm. The communication objects of the safety function are generally controlled by weather stations, which use sensors to record temperature, wind speed and rain.

The safety functions are programmed and configured in common for all shutter/blind outputs. The different outputs of the actuator can be separately assigned to all or to individual safety functions. Only assigned outputs react to a change of state of the safety objects. The reactions at the beginning of an alarm message ("1" telegram) or at the end of an alarm message ("0" telegram) can be parameterized for each channel.

As the outputs can also be assigned to several safety alarms, the priority of incoming alarm messages can be preset for several channels. Thus, the three wind alarms have the same priority with respect to one another (logic OR). The order of priority of the wind alarms with respect to the frost alarm or to the rain alarm can be parameterized.

The communication objects for the safety alarms can be monitored for the arrival of cyclical telegrams. If no telegrams are received within a presettable time, the actuator activates the safety travel movement for the outputs assigned. The safety function is terminated when a new "0" telegram is received.

For the wind alarms, the rain alarm and the frost alarm, different monitoring times between '1 minute' and '23 hours 59 minutes' can be separately selected in the ETS. A common time is configured for the wind alarms. Each wind alarm has its own timer so that the wind objects are separately checked for telegram updates.

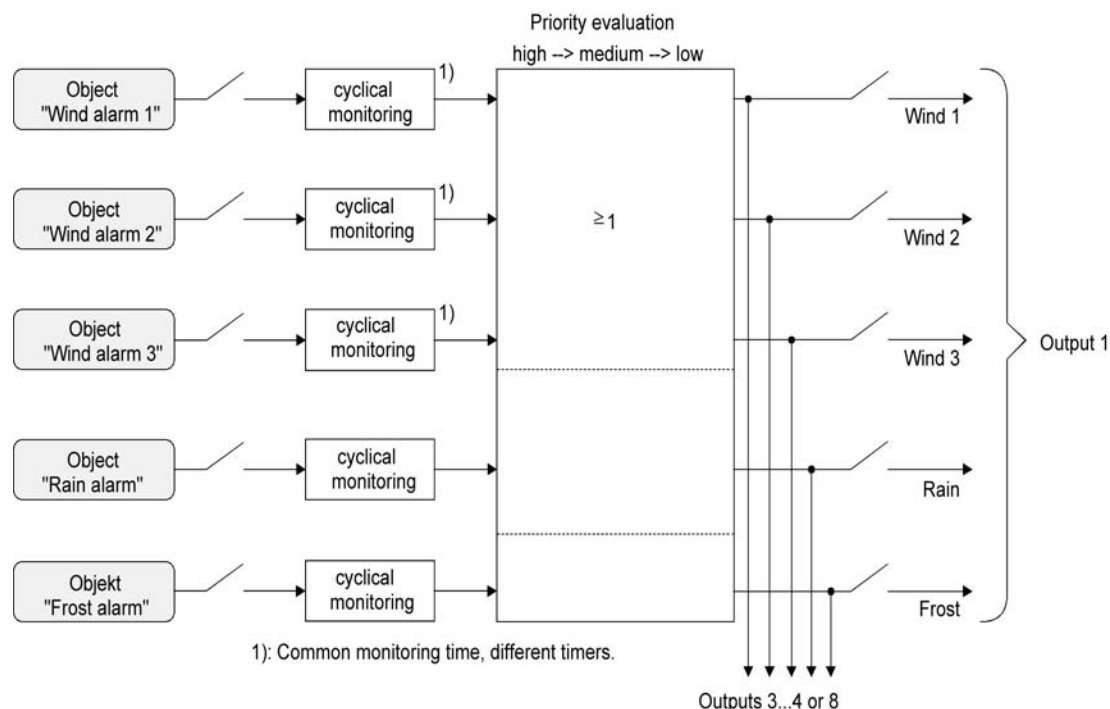

Figure 11: Function diagram of the safety function

Enabling the safety functions

The safety functions must first be globally enabled before they can be parameterized and used. After global enabling, the individual safety alarms can be enabled or disabled independently of one another.

- Set the parameter "Safety functions" on the "Safety" parameter page to "enabled".
The safety functions are globally enabled and the other parameters and the parameter page "Safety times" become visible.
- Set the parameters "Wind alarm 1", "Wind alarm 2", "Wind alarm 3", "Rain alarm" and "Frost alarm" depending on functional requirements to "enabled". The "disabled" option deactivates the corresponding alarm.

The necessary safety alarms are now enabled. The safety objects are visible and can be linked with group addresses.

- i** It should be noted that the channel-oriented assignment of blind outputs to the safety alarms (on parameter pages "Ax – Safety"; x = number of output) is operational only after the corresponding alarm has been enabled. Otherwise, an assignment is without function.
- i** An update of the safety objects ("ON" to "ON" or "OFF" to "OFF") shows no reaction.
- i** After failure of the supply voltage (bus and mains voltage failure) or after programming with the ETS, the safety functions are always deactivated. If only the mains voltage or only the bus voltage fails, the object states of the safety functions are not lost and the functions remain activated, if they were activated before. In this case it should be noted, however, that the device executes the parameterized action (parameter "Behaviour after bus or mains voltage return") when the bus or the mains voltage is restored. After such action, the outputs are, however, safety-locked and cannot be operated via the bus anymore unless the safety functions assigned are terminated.

Presetting the safety priorities

If several safety alarms are assigned to an output, it is important to preset the priority of the incoming safety telegrams. An alarm with a higher priority overrides the alarms with the lower priorities. When a safety alarm with the higher priority has ended, the safety alarm with the lower priority is executed on condition that it is active.

The safety functions must have been globally enabled.

- Arrange the "Priority of safety alarms" parameters on the "Safety" parameter page in the required order of priority.
- ❗ The three wind alarms have the same priority with respect to one another (logic OR). The last telegram update to the wind alarm objects decides which of the wind alarms will be executed. The wind alarm is completely deactivated for an assigned output only after all three objects are inactive ("0").

Presetting cyclical monitoring

If cyclical telegram monitoring of the safety objects is necessary, the individual monitoring functions must be activated separately. The monitoring functions must be enabled and the monitoring times preset on the "Safety times" parameter page.

The safety functions must have been globally enabled.

- If monitoring of the wind alarms is to be activated, the parameter "Use wind alarm monitoring function ?" must be set to "yes".
The monitoring function for the wind alarm objects is now activated. As soon as the monitoring function is activated, telegrams must be transmitted cyclically to all enabled wind alarm objects. If only one of the wind alarm telegrams is missing within the monitoring period, the wind alarm reaction will be executed for the output concerned.
- Specify the required monitoring time for the wind alarm objects in the "Wind alarm monitoring times" parameters.
- If the monitoring function is to be activated for a rain alarm, the parameter "Use rain alarm monitoring function ?" must be set to "yes".
The monitoring function for the rain alarm object is now activated. As soon as the monitoring function is activated, telegrams must be transmitted cyclically to the rain alarm object.
- Specify the required monitoring time for the rain alarm object in the "Rain alarm monitoring times" parameters.
- If the monitoring function is to be activated for a frost alarm, the parameter "Use frost alarm monitoring function ?" must be set to "yes".
The monitoring function for the frost alarm object is now activated. As soon as the monitoring function is activated, telegrams must be transmitted cyclically to the frost alarm object.
- Specify the required monitoring time for the frost alarm object in the "Frost alarm monitoring times" parameters.
- ❗ The monitoring function for the wind alarms may only be activated, if at least one wind alarm has been activated on the "Safety" page.
- ❗ The cycle time of the transmitters should be shorter than the monitoring time parameterized in the blind actuator in order to ensure that at least one telegram can be received during the monitoring time.

4.2.4.2 Channel-oriented functional description

Operating mode

Each output of the Venetian blind actuator can be independently configured for the drive type connected by defining the mode of operation. The device permits controlling slatted Venetian blinds, roller shutters, awnings and also venting louvres. Depending on the preset operating mode, the ETS adapts the parameters and communication objects for all functions of an output. For example, in the "Venetian blind" operation mode, there are also parameters and objects for slat control. There is no slat control in the "Roller shutter / awning" operating mode, but a fabric stretching function can be configured for awning use. In the "Venting louvre" operation mode, a distinction is made between the "Closing" and "Opening" drive movements, instead of an up or down movement for Venetian blinds or roller shutters.

In this documentation, Venetian blinds, roller shutters or awnings are also designated with the term "blind", if the text does not explicitly refer to a particular function (e.g. slat control). In all modes it is possible to specify positions.

Presetting the operating mode

The parameter "Mode of operation" exists separately for each shutter output on the parameter page "Ax General" (x = number of output).

- Select the required operating mode in the "Operating mode" parameter.
- i** The "Operating mode" parameter has an influence on many channel-oriented parameters and communication objects. When the operating mode is changed in the ETS, the parameters are adapted dynamically so that settings already made or links between group addresses can be reset. For this reason, the required operating mode should be configured at the beginning of the channel-oriented device configuration.
- i** Venting louvres must be connected to the outputs in such a way that they are opened in the movement direction "up - ▲" and closed in the movement direction "down - ▼".
- i** An awning travels upwards when it is rolled up.

Behaviour in case of bus voltage failure, after bus or mains voltage return or after programming with the ETS

The preferred relay contact positions in case of bus voltage failure, bus or mains voltage return or after ETS programming can be preset separately for each output. Since the actuator is equipped with mains-dependent monostable relays, the relay switching state at bus voltage failure can be defined as well.

Presetting the behaviour after ETS programming

The parameter "Behaviour after ETS programming" can be preset separately for each output channel on the parameter page "Ax General" (x = number of output). This parameter can be used to define the output relay behaviour independent of the behaviour after bus or mains voltage return.

Depending on the selected mode of operation, the ETS adapts the designations of the parameter settings ("raising" ↔ "opening the louver" / "lowering" ↔ "closing the louver").

- Set the parameter to "stop".
After programming with the ETS, the actuator switches the relays of the output to the "stop" position. A travel movement, if any, will be interrupted.
- Set the parameter to "raising" or "opening the louver".
After programming with the ETS, the actuator raises the curtain or opens the venting louver.
- Set the parameter to "lowering" or "closing the louver".
After programming with the ETS, the actuator lowers the curtain or closes the venting louver.
- i** At the beginning of each ETS programming cycle, the blind actuator always executes a "stop" command for all outputs. The manual mode, if active, will be terminated.

- i** With automatic end position detection: An ETS download of the application program or of the parameters overwrites the travelling times learnt. For this reason, it is necessary after such ETS downloads to repeat the end position detection procedure as described in chapter "Commissioning".
- i** The "Behaviour after ETS programming" as parameterized will be executed after every ETS application or parameter download. A simple download of the physical address alone or partial programming of only the group addresses has the effect that this parameter is disregarded and that the parameterized "Behaviour after bus or mains voltage return" will be executed instead. For outputs with end position detection also the travelling times learnt will be retained in this case.
- i** Programming with the ETS is possible when the bus voltage line is connected to the blind actuator and the bus voltage supply is on. An ETS download does not require the mains voltage supply to be on. If programming with the ETS was performed with bus voltage only, the parameterized "Behaviour after ETS programming" will only be executed when also the mains voltage supply of the actuator has been switched on. The "Behaviour after bus or mains voltage return" will not be activated in this case.
This reaction must be taken into account especially with actuators that are installed in pre-programmed condition into an existing electrical installation.
- i** After programming with the ETS, the safety functions, the forced positions and the sun protection function are always deactivated.

Behaviour in case of bus voltage failure presetting

The parameter "Behaviour in case of bus voltage failure" can be preset separately for each output channel under "Ax General" (x = number of output). The parameter defines the behaviour of a blind output if only the bus voltage fails. The parameterized behaviour will not be executed if manual control is active at the time of bus failure (status LEDs flashing for temporary or permanent manual control).

Depending on the selected mode of operation, the ETS adapts the designations of the parameter settings ("raising" ↔ "opening the louver" / "lowering" ↔ "closing the louver").

- Set the parameter to "stop".
In case of bus voltage failure, the actuator switches the relays of the output to the "stop" position. A travel movement, if any, will be interrupted.
- Set the parameter to "raising" or "opening the louver".
After bus voltage failure, the actuator raises the curtain or opens the venting louver.
- Set the parameter to "lowering" or "closing the louver".
After bus voltage failure, the actuator lowers the curtain or closes the venting louver.
- Set the parameter to "position approach".
In case of bus voltage failure, the connected drive can approach a position specified by further parameters (0...100 %). If blinds are controlled with the device, the slats can be positioned independently. The blind actuator performs a reference travel before the position approach, if the current position at the time of bus failure is unknown (e.g. due to power supply failure or to previous ETS programming).
- Set the parameter to "no reaction".
In the event of bus voltage failure, the relay of the output shows no reaction. Motions still in progress at the time of failure will still be completed as long as the mains voltage supply is still on.
- i** Safety, forced position or sun protection functions (independent of the selected priority) remain active even after a bus voltage failure as long as the mains voltage supply is still on. These functions will therefore be executed again at the end of a temporary or permanent manual control (if enabled in case of bus failure) even if there is no bus voltage.
- i** When the still ongoing motion or the motion parameterized in case of bus voltage failure has come to an end, the outputs can no longer be activated except by manual control (if the mains voltage is on and if manual control is enabled) or by bus/mains voltage return.

- i** A bus voltage failure will in any case result in a stop of all time functions. Thus, all scene recalls in the delay phase will be aborted and all delay times for sun protection and presence will be ended by ignoring the object value last received and still in the delay phase. A telegram update received shortly before bus voltage failure is then lost, if the corresponding delay has not yet elapsed.
- i** In the event of a mains voltage failure, all relays of the actuator will always drop out ("stop") independent of the bus voltage condition. In this state, the outputs are no longer selectable. Time functions (scene, sun protection and presence delays) are not interrupted, if only the mains voltage fails.
- i** In case of bus or mains voltage failure, the current position data of the outputs are permanently stored in the device so that the corresponding positions can be precisely tracked after bus or mains voltage return, if so parameterized. The data are stored before the reaction parameterized for the case of bus voltage failure and only if one part of the supply (mains or bus) is still present, or if the supply fails completely after the mains voltage has been available before without interruption for at least 20 seconds after the last reset (storage capacitors sufficiently charged for storage purposes). The data will not be stored, if the position data are unknown. Storage of data after failure of one part of the supply voltage happens only once...

Example 1:

Bus voltage failure -> Data storage -> Then mains voltage failure -> No further data storage,

Example 2:

Mains voltage failure -> Data storage -> Then bus voltage failure -> No further data storage.

The following rules apply for the position data to be stored:

The current curtain, slat and louver positions are stored. With blinds, the height to be stored is always referred to a slat position of 100 % (cf. "Calculating the slat position"). Positions temporarily approached will be stored also for those outputs that are involved in a travel movement at the time of data storage. On account of the fact that position data are stored as integer percentage values (0...100), a minor deviation from the positions reported back later during bus or mains voltage return (number range 0..255) cannot be avoided.

As the position values are stored only once during bus voltage failure, such positions as are varied by manual control after bus voltage failure cannot be tracked. Similarly, forced position telegrams received via the bus after a mains voltage failure or slat offset positions for the sun protection function cannot be stored and tracked either.

Stored position data are not lost during programming with the ETS.

- i** In case of bus or mains voltage failure, the current states of the forced position control or – if parameterized – also the slat offsets of the sun protection positions are stored as well.

Presetting the behaviour after bus or mains voltage return

The parameter "Behaviour after bus or mains voltage return" can be preset separately for each output channel on the parameter page "Ax General" (x = number of output).

Depending on the selected mode of operation, the ETS adapts the designations of the parameter settings ("raising" ↔ "opening the louver" / "lowering" ↔ "closing the louver").

- Set the parameter to "stop".
In case of bus or mains voltage return, the actuator switches the relays of the output to the "stop" position. A travel movement, if any, will be interrupted.
- Set the parameter to "raising" or "opening the louver".
After bus or mains voltage return, the actuator raises the curtain or opens the venting louver.
- Set the parameter to "lowering" or "closing the louver".
After bus or mains voltage return, the actuator lowers the curtain or closes the venting louver.
- Set the parameter to "position during bus / mains failure".

After bus or mains voltage return, the position value (including the slat position in the case of blinds) last selected and stored internally before bus or mains voltage failure will be tracked. The blind actuator performs a reference travel before the position approach, if the current position at the time of bus or mains voltage return is unknown (e.g. due to complete power supply failure or to previous ETS programming).

- Set the parameter to "position approach".

In case of bus or mains voltage return, the connected drive can approach a position specified by further parameters (0...100 %). If blinds are controlled with the device, the slats can be positioned independently. The blind actuator performs a reference travel before the position approach, if the current position at the time of bus or mains voltage return is unknown (e.g. due to complete power supply failure or to previous ETS programming).
- Set the parameter to "no reaction".

In the event of bus or mains voltage return, the relay of the output shows no reaction. Ongoing travel movements at the time of voltage return are completed.
- ❖ "Position during bus / mains failure" setting: If no position values could be stored in case of bus or mains voltage failure because the position data were unknown (no reference travel executed), the actuator shows no reaction with this parameterization either.
- ❖ "No reaction" setting: The commands received via the bus during a mains voltage failure (bus voltage present) are tracked when the mains voltage returns. Interrupted short- or long-time travel movements – if not completed – are restarted at full length and position approaches are continued from the break point.
- ❖ All time functions (scene, sun and presence delay) are only stopped in case of bus voltage failure so that a mains voltage failure does not result in a loss of states or time functions as long as the bus voltage is present.
- ❖ The parameterized behaviour is always executed independent of the current states of the safety or sun protection function. Safety and sun protection function can nonetheless be active even after bus or mains voltage return, if these functions have been activated before a bus voltage failure or before or during a mains voltage failure. Any direct operation can thus be overridden.

Only in case of a complete supply failure (bus voltage and mains voltage) are the sun protection or the safety functions deactivated.
- ❖ The communication object of the forced position function can be initialized separately after bus voltage return. This has an effect on the reaction of the output when the forced position is activated. A mains failure alone has no effect on the forced position. In case of a return of only the mains voltage, a previously activated forced position remains active.

The parameterized "Behaviour on return of bus or mains voltage" will only be adopted if no forced position is activated after bus voltage return.
- ❖ An active manual control is terminated on return of bus voltage. In case of mains failure, no manual control is possible.
- ❖ The device executes the parameterized "Behaviour after bus or mains voltage return" only if more than ca. 20 s have elapsed between the last ETS download of the application or of the parameters and the time when bus and mains voltage are restored. Otherwise ($T_{ETS} < 20$ s), the "Behaviour after ETS programming" will be executed also in case of a bus/mains voltage return.

If only the bus or the mains fails after an ETS download and is then restored, the actuator executes the "Behaviour after bus or mains voltage return".

Determining and configuring short-time and long-time operation

The short-time operation (Step) permits adjusting the slat tilting angle of a blind or the 'slit opening width' of a shutter. In most cases, short-time operation is activated by pressing a blind pushbutton sensor permitting manual intervention in the blind/shutter control cycle. When the actuator receives a short-time command while the blind, shutter, awning or louver is in motion, the travel movement is stopped immediately by the blind actuator.

Long-time operation (Move) is determined by the travelling time of the connected blind, shutter, awning or louver and must therefore not be preset separately. The travelling time can either be measured 'manually' and the parameters entered in the ETS or, as an alternative, automatically determined by using the automatic end position detection procedure. The control

of an output by means of a long-time or a short-time telegram is also designated as 'direct operation'.

To ensure that the curtain or the louver has definitely reached its end position at the end of long-time operation, the blind actuator always prolongs the long-time travel movement by 20% of the parameterized or learnt travelling time.

The parameterized travelling time extension will moreover be taken into account by the actuator for all upward travels or all travel movements into the open position as the drive motors are then generally not so fast due to the weight of the curtains or to external physical influences (e.g. temperature, wind, etc.). Thus, it is ensured that the upper end position is always reached even in case of uninterrupted long-time travel movements.

- i** A long-time or a short-time operation can be retriggered by a new incoming long-time or short-time telegram.
- i** A travel movement activated in the manual control mode or by a safety function is always a long-time operation. The "raising" or "lowering" commands parameterized in the ETS will equally activate the long-time operation.

Presetting the short time operation

Short-time operation is configured separately for each output and independent of the travelling time of the curtain or of the louvre. It is possible to specify in the ETS whether the output executes only a "stop" for a travel movement on reception of a short time telegram or whether the output is activated for a specific duration.

- Set the parameter "Short time operation" on parameter page "Ax - Time settings" (x = number of output) to "yes".

The Venetian blind actuator activates the output concerned for the time specified under "Duration of short time operation" when a short time telegram is received and when the output is not in the process of executing a travel movement. If the output is executing a travel movement at the time of telegram reception, the output will only just stop.

- Set the parameter "Short time operation" on parameter page "Ax - Time settings" (x = number of output) to "no (only stop)".

The Venetian blind actuator will only stop the output on reception of a short time telegram, if the output is in the process of executing a travel movement. There will be no reaction, if the output is not executing a movement at the time of telegram reception.

- i** The configured "Duration of short time operation" should correspond, for a Venetian blind, to approx. $\frac{1}{4}$ of the complete slat moving time and for a roller shutter to the full time needed for opening the roller shutter segments.
- i** The short time operation is always executed without a movement time extension.

Determining and configuring travelling times

For computing positions and also for executing long-time operation, the blind actuator needs the exact travelling time of the connected blind, shutter, awning or louver. Without using the automatic end position detection, the travelling time for a blind output must be measured 'manually' and entered as a parameter into the ETS. It is important to determine the travelling time accurately to permit positions to be approached with good precision. Therefore, it is recommended to make several time measurements and to take the average of these values before entering them into the corresponding parameter. The travelling time corresponds to the duration of a travel movement from the completely open position (upper end position / awning rolled up) to the completely closed position (lower end position / awning completely unrolled) and not vice versa! The travelling times are to be determined as a function of the different types of movements.

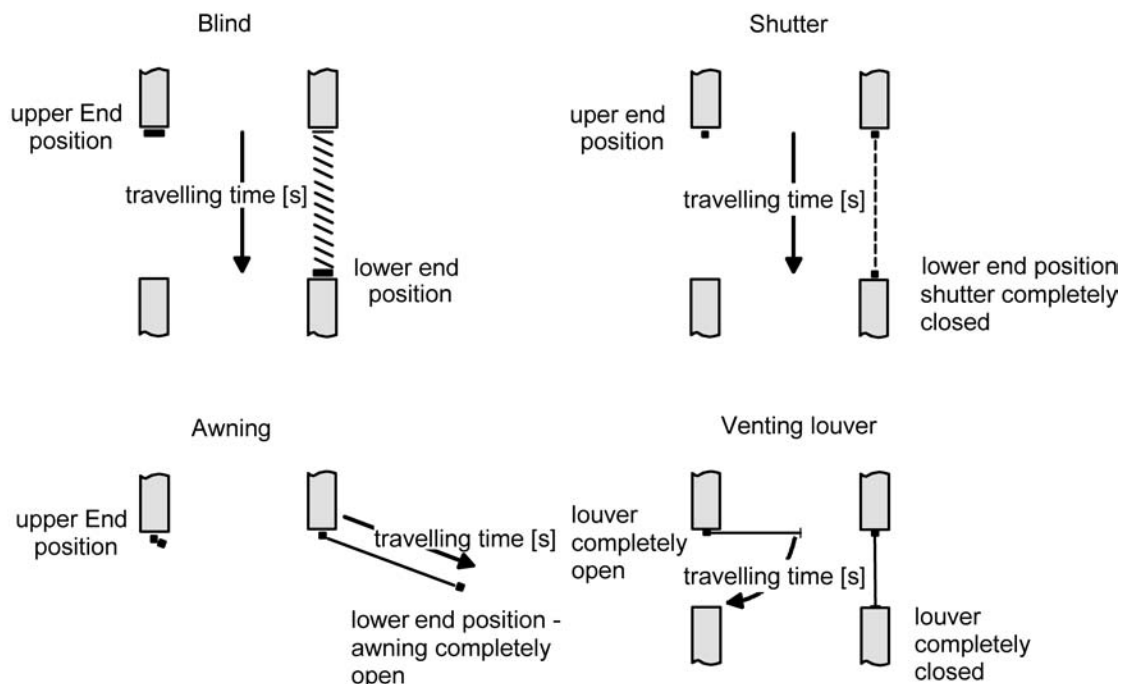

Figure 12: Travelling time as a function of the type of movement

Presetting the travelling time of blinds, shutters, awnings and louvers without automatic end position detection

The measurement of the travelling time is described in detail in chapter "Commissioning".

The automatic end detection position must be deactivated.

- Enter the exact travelling times determined in the course of the commissioning procedure into the parameters "Blind travelling time" or "Shutter/awning travelling time" or "Venting louver travelling time" on parameter page "A1 – Time settings" (x = number of output). The maximum travelling time is '19 minutes 59 seconds. The working principle does not allow longer travelling times.

i The parameterized travelling time extension will moreover be taken into account by the actuator for all upward travels or all travel movements into the open position as the drive motors are then generally not so fast due to the weight of the curtains or to external physical influences (e.g. temperature, wind, etc.).

Presetting the travelling time of blinds, shutters, awnings and louvers with automatic end position detection

If 230 V AC motors with mechanical limit switches are connected to the outputs, the travelling time of the blind, shutter, awning or louver can also be automatically determined. If the automatic end position detection function is used, a learning travel movement must be performed during commissioning. The blind output concerned is ready for full use only after the travelling time has been correctly determined (otherwise no position approaches or position feedback telegrams possible).

The measurement of the travelling time with automatic end position detection is described in detail in chapter "Commissioning".

- Set the parameter "Automatic end position detection ?" on parameter page "Ax - Time settings" (x = number of output) to "yes".

The end position detection can be performed after ETS programming.

i The blind actuator stores the travelling times in an NV memory (EEPROM) so that the times are valid even after a power supply failure. After each programming run with the ETS, the end position detection procedure must be repeated.

- i** Without stored travelling times, the blind actuator generates an "Invalid position" message for each output which can also be transmitted to the bus, if parameterized. The evaluation of this message can be used as an indicator for a successful teaching procedure.
- i** In operation, the blind actuator regularly adapts itself to changes in the curtain travelling times (e.g. ageing of the drives). In case of deviations from the original value, the travelling time thus determined will be used temporarily for computing the positions and stored only in a volatile memory (RAM).
- i** In addition to the times programmed during the first commissioning after ETS programming, the user always has the possibility of re-teaching travelling times 'manually' thereafter. To do so, the user must activate the permanent manual control mode (cf. chapter "Operation") and move the blind/shutter without interruption from one end position into the other. Simple travel movements (from top to bottom or vice versa) are sufficient for programming a new travelling time which is then stored in an NV memory.
- i** In case of slatted blinds, the travelling time of the slats cannot be taught by automatic end position detection. In this case, the actuator always resorts to the value parameterized in the ETS. As the slat moving time is in a fixed proportion to the travelling time of the curtain, a correction of the travelling time of the curtain automatically entails a correction of the slat moving time.
- i** The maximum travelling time is basically limited to 20 minutes. If the process of learning a new travelling time is not terminated after 20 minutes (no limit position detected), the actuator will end the learning process by itself (stop). The minimum travelling time is limited to 1 second.
- i** If the actuator was not in a position to learn a correct travel time (e.g. teaching runs longer than 20 minutes, no end position detection after ETS programming or abortion of travel before reaching an end position), the travelling time is not valid. In this case, the output concerned cannot approach fixed positions. If position values are nevertheless transmitted or activated via the bus (e.g. sun protection), the actuator translates all values between 0...49% (0...127) into an upward travel and all position values between 50% ...100% (128...255) into a downward travel. The travelling time corresponds in this case to the maximum travelling time (20 minutes).
- i** At first, the actuator determines a travelling time extension during the automatic travelling time measuring procedure. The travelling time extension can therefore not be parameterized separately. The travelling time extension will be taken into account by the actuator for all upward travels or all travel movements into the open position as the drive motors are then generally not so fast due to the weight of the curtains or to external physical influences (e.g. temperature, wind, etc.).

Determining and configuring the slat moving time (only with slatted blinds)

If blinds are used, the slats can be positioned independently. To enable the blind actuator to compute slat positions and to report them back to the bus, it is necessary that the actuator gets precise information about the time required for a slat rotation – even with automatic end position detection. The slat moving time must in each case be determined 'manually' and entered into the parameters.

The blind actuator is designed for controlling single-motor blind drives without working position. In this drive mode, the slats are directly adjusted by way of mechanical linkage when the height of the blind is changed. The actuator assumes that the slats are completely closed when the blind moves downwards. The actuator assumes that the slats are completely closed when the blind moves downwards (Figure 13). These blinds are the most common type on the market.

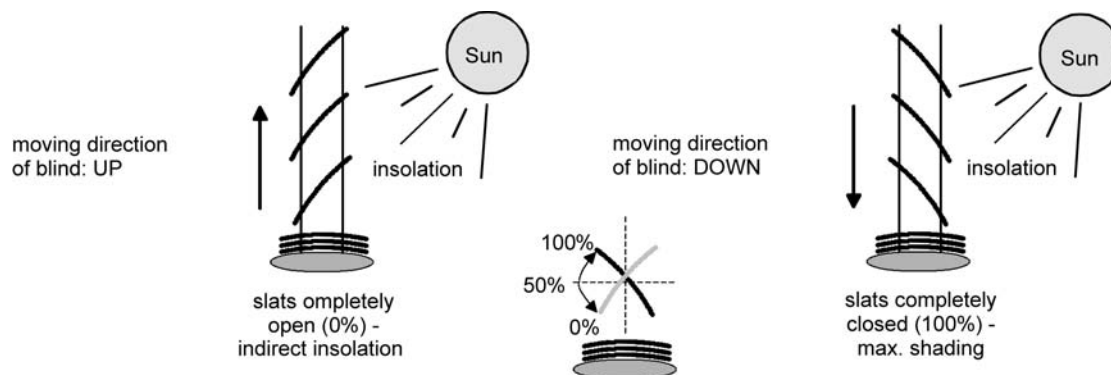

Figure 13: type 1 - slatted blinds with oblique slat position in both travel directions

There are also single-motor blind systems without working position the slats of which are horizontal during an upward travel and oblique during a downward travel. Such blind types can also be connected to the actuator in which case a completely open slat position corresponds to the slats in horizontal position (Figure 14).

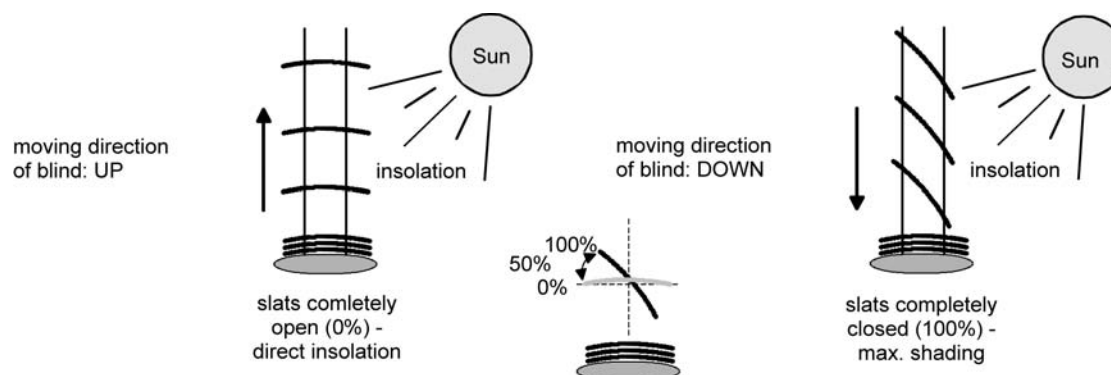

Figure 14: Type 2 - slatted blinds with oblique and horizontal slat position

Presetting the slat moving time

The measurement of the slat moving time is described in detail in chapter "Commissioning".

- Set the parameter "Slat moving time" on parameter page "Ax – Times" (x = number of output) exactly to the value determined in the course of the commissioning procedure.
- i** The slat moving time must be shorter than the preset or learnt curtain travelling time.
- i** The parameterized or measured travelling time extension will also be taken into account when slats are moved into the completely open position (upward travel).
- i** With automatic end position detection: During the automatic travelling time adaptation (e.g. in the case of drive ageing), the parameterized slat moving time – which is in a fixed proportion to the modified curtain travelling time – will internally be adapted as well. The adapted slat moving time is stored only temporarily and used in operation for the exact calculation of the slat tilting angle.

Determining and configuring the travelling time extension and the change-over time

When travelling upwards, blinds, shutters or awnings have a tendency of moving more slowly due to their own weight or to external physical influences (e.g. temperature, wind, etc.). The same applies to venting louvers where opening may take longer than closing.

For this reason, the blind actuator takes the parameterized travelling time extension into account when moving upwards or when opening the louvers. The extension is computed as a percentage representing the difference in the travelling times in the two directions. The travelling time extension must be determined during commissioning separately for each

output and entered into the ETS parameters. If the automatic end position detection is used, the blind actuator auto-determines the required travelling time extension when learning the travelling times. In this case, a separate parameterization of the time extension is not needed. The measurement of the travelling time extension is described in detail in chapter "Commissioning".

Example showing the calculation of the travelling time extension:

- "Travelling time" previously determined and parameterized: $T_{OU} = 20$ seconds,"
- Time determined for travel from lower to upper end position: $T_{UO} = 22$ seconds,
- Calculated supplementary travelling time: $T_{UO} - T_{OU} = 2$ seconds ->
2 seconds out of 20 seconds are 10 %,
- Travelling time extension to be parameterized: 10 %.

To protect the drive from irreparable damage, a fixed pause during travel direction change-over can be parameterized for each output – even with automatic end position detection. During the pause, no travel direction is active ("stop"). The necessary parameter value can normally be found in the technical documents of the drive motor used. The change-over time is accounted for in every state of operation of the actuator.

Presetting the travelling time extension

The automatic end detection position must be deactivated.

- Enter the determined travelling time extension (by rounding up the determined extension value) into the parameter "Travelling time extension for upward travel" on parameter page "Ax – General" (x = number of output).

Presetting the change-over time for travel direction changes

- Set the parameter "Change-over time for travel direction changes" on parameter page "Ax Time Settings" (x = number of output) to the required change-over interval.

i When the actuator is delivered ex factory, the change-over time is generally preset to 1 s.

Computing the curtain height or the louver position

The blind actuator has a comfortable and accurate positioning function. The actuator calculates the current position of the connected blind, shutter, awning or louver whenever these elements are adjusted either by manual or bus control. The calculated position value is a measure of the height of the curtain or of the opening width of the venting louver (Figure 15).

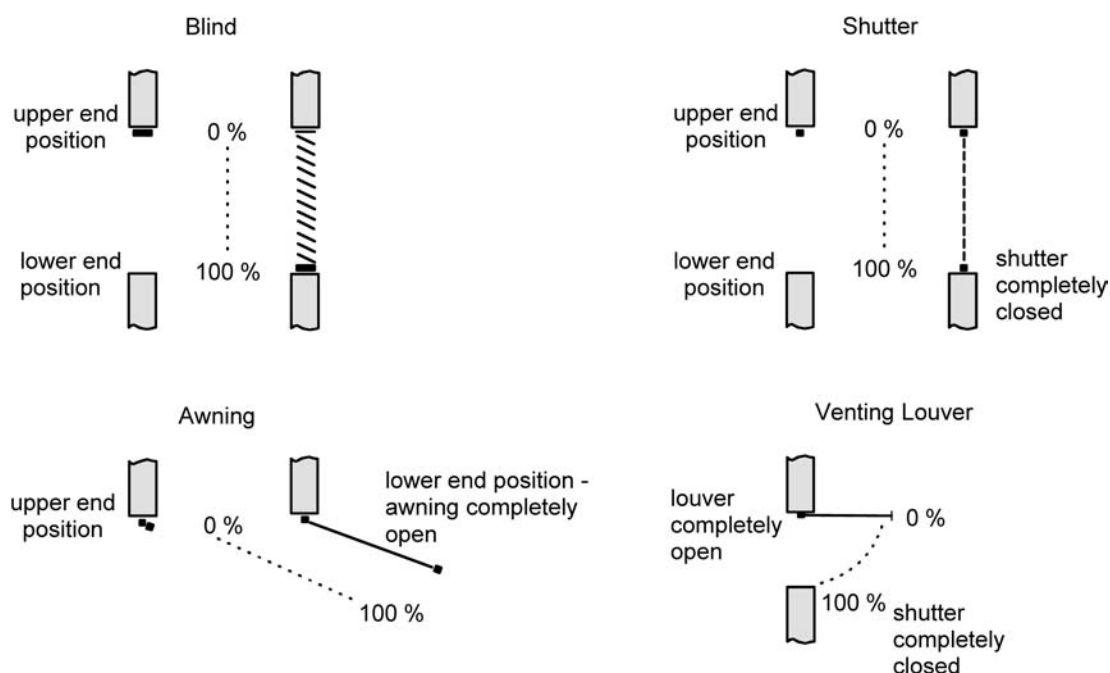

Figure 15: Positions defined as a function of the type of movement

The blind actuator derives the positions from the parameterized travelling time or from the travelling time as determined by the end position detection since conventional drives do not provide feedback about their positions. Thus, the travelling time separately parameterized for each blind output is the reference for all position approaches and of basic importance for the accuracy of the position calculations. For this reason, the travelling times should be determined with great accuracy in order to achieve the best possible positioning results.

For positioning purposes, the blind actuator calculates the travelling time required as a function of the current position.

Example 1...

The shutter connected to a certain output has an overall travelling time of 20 s. The shutter is in its upper end position (0 %). It is to be positioned at 25 %. The actuator calculates the travelling time required for approaching the desired position: $20 \text{ s} \times 0.25_{(25 \%)} = 5 \text{ s}$. The output will then lower the shutter for 5 s and thus position the curtain at height of 25 %.

Example 2...

The shutter connected to a certain output has an overall travelling time of 20 s. The shutter is in the 25 % position. It is to be positioned at 75 %. The difference between the positions is 50 %. The actuator calculates the travelling time required for bridging the difference between the positions: $20 \text{ s} \times 0.5_{(50 \%)} = 10 \text{ s}$. The output will then lower the shutter for 10 s and thus position the curtain at height of 75 %.

For all upward travels, the travelling time extension parameterized or determined by end position detection will automatically be added to the travelling time calculated.

Example 3...

The shutter connected to a certain output has an overall travelling time of 20 s. The shutter is in the 75 % position. It is to be positioned at 25 %. The difference between the positions is 50 %. The actuator calculates the travelling time without extension required for bridging the difference between the positions:

$20 \text{ s} \times 0.5_{(50 \%)} = 10 \text{ s}$. Taking the travelling time extension into account (e.g. 10 %), the actual raising time is: $10 \text{ s} \times ((100 \% + 10 \%_{(\text{extension})}) : 100 \%) = 10 \text{ s} \times 1.1 = 11 \text{ s}$. The output will then raise the shutter for 11 s and thus position the shutter curtain at a height of 25 %.

Then the lower or upper end positions (0 % or 100 %) are approached, the travelling time is always 20 % longer than the overall travelling time.

Example 4...

The shutter connected to a certain output has an overall travelling time of 20 s. The shutter is in the 50 % position. It is to be positioned at 100 %. The difference between the positions is 50 %. The actuator calculates the travelling time required for bridging the difference between the positions: $20 \text{ s} \times 0.5_{(50 \%)} = 10 \text{ s}$. Since the travel movement is to an end position, the actuator adds on a fixed amount of 20 % of the overall travelling time:

$10 \text{ s} + (20 \% : 100 \%) \cdot 20 \text{ s} = 14 \text{ s}$. The output will then lower the shutter for 14 s and thus position the curtain reliably at height of 100 %.

Example 5...

The shutter connected to a certain output has an overall travelling time of 20 s. The shutter is in the 50 % position. It is to be positioned at 0 %. The difference between the positions is 50 %.

The actuator calculates the travelling time without extension required for bridging the difference between the positions: $20 \text{ s} \cdot 0.5_{(50 \%)} = 10 \text{ s}$. Since the travel movement is to an end position, the actuator adds on a fixed amount of 20 % of the overall travelling time:

$10 \text{ s} + (20 \% : 100 \%) \cdot 20 \text{ s} = 14 \text{ s}$.

Taking the travelling time extension into account (e.g. 10 %), the actual raising time is:

$14 \text{ s} \times ((100 \% + 10 \%_{(\text{extension})}) : 100 \%) = 14 \text{ s} \times 1.1 = 15.4 \text{ s}$. The output will then raise the shutter for 15.4 s and thus position the shutter curtain at a height of 0 %.

i The blind actuator executes position approaches only if a new position deviating from the current position is preset.

- i** The blind actuator stores the blind/shutter/awning or louver positions temporarily. The blind actuator can approach newly preset blind/shutter/awning or louver positions only if the current positions are known. For this purpose, each output must be given the opportunity to synchronize itself whenever the supply voltage is switched on or after every ETS programming run (physical address, application program, partial download). The synchronization is performed with the help of a reference travel (cf. "Reference travel").
- i** Position approaches in progress will be aborted in case of bus or mains voltage failure. In case of bus voltage failure, the parameterized behaviour will be executed. In case of mains failure, the drives will be stopped. Position approaches are also interrupted when the manual control mode is activated.

Calculating the slat position (only with blinds)

In the "blinds" mode of operation, the blind actuator always calculates the slat position so that the opening angle and thus the amount of light admitted into the room by the blind can be adjusted. A new position approach by a blind will always be followed by a positioning movement of the slats. Thus, the slat positions last selected will be tracked or readjusted to a new value if a position change has taken place.

In case of single-motor blind drive systems with working position, the slats will be readjusted directly by a change of the blind curtain height. For this reason, an adjustment of the slat position will always have an influence on the position of the blind itself (Figure 16).

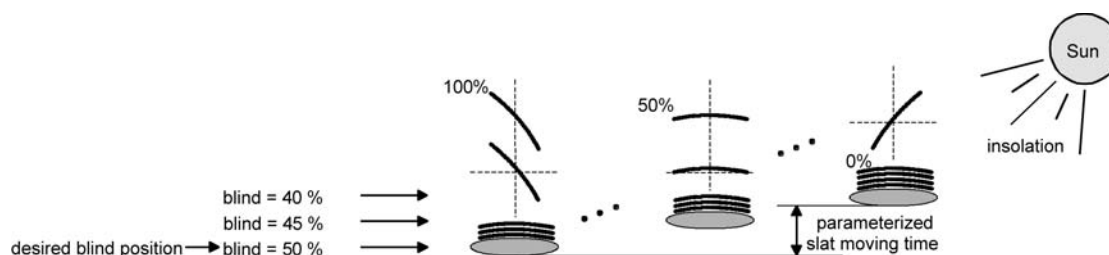

Figure 16: Example of slat positioning affecting the position of the blind (typical of slat type 1; analogous reaction for type 2.)

Since a preset slat position is to remain constant until the next change, the actuator will not change the height of the blind, if the calculated travelling time required for a change of position lies within the parameterized slat moving time.

Similarly, the actuator accounts for the ratio of the moving times of slat and blind and – in case of slat position changes – always recalculates the resulting blind position. If the position feedback objects are used (cf. "Position feedback"), the actuator transmits the blind positions changed by the adaptation also to the bus.

Example (Figure 16)...

The blind position is preset to 50 %. A change of the slat angle (100 %...0 %) initiates the calculation of a new blind position which is also tracked in the position feedback objects. If the actuator is to approach a new blind position of, let's say 47 % in this case, the actuator will not perform a travel movement as the calculated travelling time lies within the parameterized slat moving time and therefore coincides with the slat movement. A change of the blind position to 55 % in this case triggers a blind movement as the change does not lie within the slat movement (0 to 100 %).

For each positioning movement, the desired blind position is referred to a slat position of 100 %. In the event of a slat re-positioning movement (0 to 100 %), the actuator will therefore report a blind position below the desired position.

Exception: The desired blind position of 0 % (upper end position) is assigned to the slat position of 0 %. The re-adjustment of the slat position will result also in this case in a change of the blind height (brief downward travel). Only in this case will the actuator report back a blind position above the desired blind position (Figure 17). With slat type 1, the slats are generally horizontal when the blind is in its upper end position. For this reason, the calculated slat position with a

slat type 1 corresponds to the actual opening angle only after the first slat is completely extended (100%).

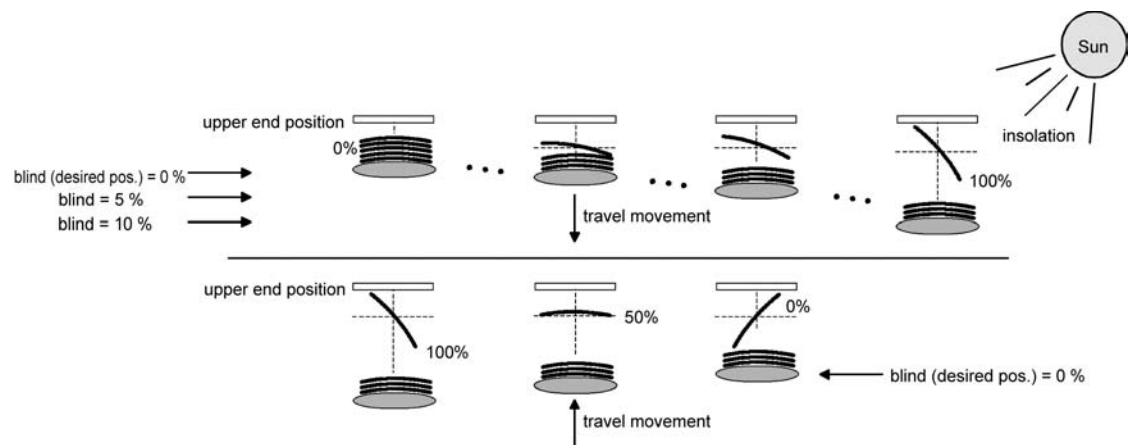

Figure 17: Example of slat positioning with the blind in upper end position (typical of slat type 1.)

Example (Figure 17)...

The blind position is preset to 50%. After an extended travel movement, the blind is safely in the upper end position. A change of the slat angle (100%...0%) initiates the calculation of a new blind position which is also tracked in the position feedback objects. If the actuator is to approach a new blind position of, let's say 5% in this case, the actuator will not perform a travel movement as the calculated travelling time lies within the parameterized slat moving time and therefore coincides with the slat movement. A change of the blind position to 55% in this case triggers a blind movement as the change does not lie within the slat movement (0 to 100%).

- i** The blind actuator executes slat position adjustments only if a new position deviating from the current slat position is preset.
- i** The blind actuator stores the slat positions temporarily. The actuator can approach newly preset slat positions only if the current position is known. For this purpose, each output must be given the opportunity to synchronize itself whenever the supply voltage is switched on or after every ETS programming run (physical address, application program, partial download). The synchronization is performed with the help of a reference travel for the slat or the blind (cf. "Reference travel").
- i** A change of the blind height will always result in a change of the slat position. After reactivation of the supply voltage or after ETS programming, the actuator will in this case generally move the slats into the 100% position, if no position has been preset for the slats.
- i** The smaller the ratio between slat moving time and blind travelling time, the more precise the position approaches and the less marked the influence of the slat angle adjustment on the height of the blind.

Reference travel

After ETS programming (physical address, application program, partial download) or after actuator supply voltage failure (bus and mains voltage) all current position data are unknown. Before the actuator can approach new positions after bus and mains voltage return or after programming, the positioning system must at first be calibrated. The positioning system can be calibrated by carrying out a reference travel.

A reference travel is the time required for a travel movement into the upper end position increased by 20% and additionally by the parameterized travel time extension (Figure 18). A reference travel is not retriggerable.

Reference travels can be executed by the following commands...

- an uninterrupted long-time travel (including also a terminated safety travel) into the upper end position activated via the corresponding communication object,
- an approach of the 0 % position,
- a manually controlled movement into the upper end position.

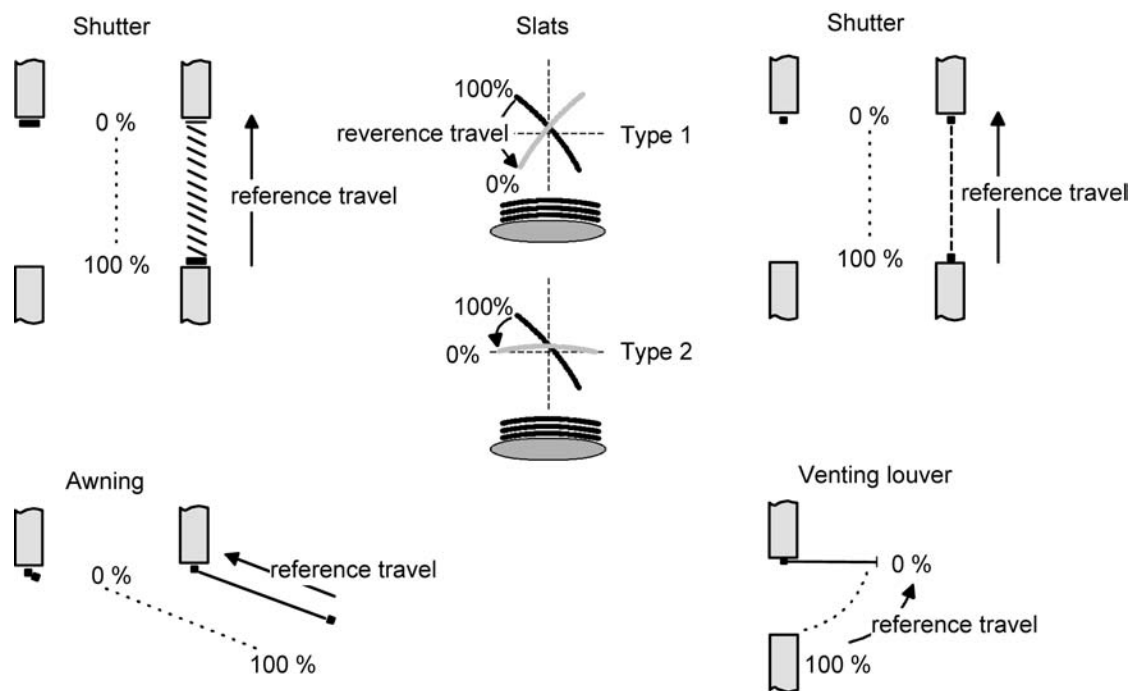

Figure 18: Reference travel

In the event of slat positioning via the corresponding communication objects after bus and mains voltage return or after programming, a slat reference movement becomes necessary if the blind has not been moved beforehand in the up or down directions for at least the parameterized slat moving time. During a slat reference movement, the actuator always moves the slats for the parameterized slat moving time into the completely open position (0 %) and then to the desired position. The slat position is also considered as calibrated when the blind has been moved by a long-time command in the up or down direction during at least the parameterized slat moving time.

- i** A terminated reference travel of the blind will also calibrate the slat position.
- i** If the reference travel is interrupted for instance by a short-time operation, the position is still unknown as before.
- i** A long-time travel into the lower end position activated via the corresponding communication object also calibrates the reference position.
- i** When the automatic end position detection is used, the reference position is automatically calibrated in the course of the initial commissioning procedure (teaching of travelling times).
- i** With the sun protection function it is moreover possible to force the actuator to perform a reference travel before each sun protection travel even if the positions are known. Thus, it is ensured that in case of sun protection the parameterized sun protection position is always precisely approached even after repeated position approaches.
- i** Using the connected drives frequently for position approaches (for instance several times a day) can result after some time in positioning inaccuracies. These deviations from the nominal position are mostly due to external physical influences. To achieve accurate positioning in operation it is recommended to perform the reference travel at least once every day. This can be achieved for instance by a central raising command transmitted to the long-time object.

Presetting the position

The following ways of presetting positions can be distinguished...

- Direct positioning via the positioning objects (direct operation),
- Positioning by activating the sun protection function,
- Position through the behaviour after bus voltage failure or bus or mains voltage return,
- Positioning by a scene recall.

Positioning via the positioning objects:

Each Venetian blind, roller shutter, awning or venting louvre can be positioned directly using the "Position ..." object, which is separate for each output. An independent positioning object exists for each of the slats. The position approached is always the position last received. The actuator does not show a reaction when the set or to be approached position value is received several times in succession.

This type of control is termed 'direct operation' just like operation via short time, long time or central objects or a scene recall. Positioning via the objects therefore has the same priority. A position movement caused by the communication objects can be interrupted at any time by a long time command, short time command, central command or a scene recall. The direct operation can be overridden by a function with a higher priority, e.g. manual control, forced position, safety or also sun protection (configurable).

The position telegrams must correspond to the 1 byte data format according to KNX datapoint type 5.001 (Scaling). The Venetian blind actuator converts the value received (0...255) linearly into a position (0...100 %) (see the following table).

Received value (0...255)	Position derived from value (0...100 %)
0	0 % (upper end position / slat or venting louvre opened)
↓	↓ (all intermediate values rounded off to 1 % increments)
255	100 % lower end position / slat or louvre closed)

Data format of positioning objects with conversion into percentage position values

It is possible that new positioning telegrams are being received while a position approach is in progress. In this case, the actuator immediately reverses the direction of travel, if the new position to be approached lies in the opposite direction.

If a slat positioning command is received during a running Venetian blind position approach, the device finishes first the Venetian blind position approach before positioning the slat. If a blind positioning command is received during a slat positioning movement, the actuator interrupts the slat positioning movement and approaches the new blind position. Only then does the actuator switch to the most recently received slat position.

In case of Venetian blind positioning, slat positioning will always be executed later. After switching on the power supply of the actuator or after programming with the ETS, it may be the case that the slat position is unknown, if no long-time command for the upward or downward travel with a duration of at least the configured slat moving time has been received or no slat positioning has taken place (no slat reference movement). In this case, the slat is moved during a Venetian blind position approach into the completely closed position (100 %). The slat position is then considered as calibrated.

- i** Optionally, the sun protection function offers the possibility of receiving the instruction of the blind height, venting louvre or slat position to be adopted during sunshine via separate communication objects and to preset these values variably. This form of variable position preset in the sun protection function is identical to presetting the positions via communication objects in direct operation. The priority of the incoming telegrams in direct operation with the sun protection activated can be additionally configured in the ETS.

Position through the sun protection function, the behaviour after bus voltage failure or bus or mains voltage return,

With the named functions of the Venetian blind actuator, the positions to be approached are configured directly in the ETS, depending on the operating mode set. The position values can be specified between 0 % and 100 % in 1 % increments.

With Venetian blinds, the height of the Venetian blind is positioned first in these cases. The configured slat position is adjusted only thereafter.

- i** Important notes for all positioning movements: Using the connected drives frequently for position approaches (for instance several times a day) can result after some time in positioning inaccuracies. These deviations from the setpoint position are mostly due to external physical influences. To achieve accurate positioning in operation it is recommended to perform the reference movement at least once every day. This can be achieved for instance by a central raising command transmitted to the long time object.

Position feedback messages

In addition to presetting positions via positioning objects, the blind actuator can track the current positions values via separate feedback objects and also transmit them to the bus, if the bus voltage is on. Thus, the preset nominal position can be distinguished from the true actual position of the drives activated.

The following feedback telegrams can be preset for each output depending on the parameterized mode of operation...

- Feedback (1 byte) of the blind, shutter, awning or venting louver position,
- Feedback (1 byte) of the slat position (only with blinds).

The individual position feedback messages can be enabled in the ETS independent of one another and have communication objects of their own.

For each travel movement the actuator calculates the current position and tracks it in the position feedback objects. The positions are tracked and the feedback objects updated even when an output has been activated via short-time or long-time telegrams or by manual control on condition that the bus voltage is on.

The feedback objects are updated after the following events...

- at the end of a travel movement – including a slat positioning movement in a blind – when the drive stops and when the new position is reached,
- in case of a travel movement into an end position already at the time the end position is reached theoretically, i.e. before the 20 % extension and the travel time extension have elapsed (exception: with automatic end position detection, the positions are updated only after the travel time has completely elapsed).

The feedback objects are not updated, if the position last reported back has not changed after a movement (for instance, when the blind is repositioned, the unchanged slat position will not be reported back a second time).

The blind actuator cannot calculate a feedback position, if the current position data after switch-on of the supply (bus voltage and mains voltage) or after ETS programming are still unknown. In these cases, the actuator must first perform a reference travel (cf. "Reference travel") so that the position can be calibrated. In case of unknown positions, the actuator automatically performs reference travels, if new positions are preset and if these positions are to be approached. As long as a position is unknown, the value of the feedback objects is "0".

Presetting position feedback for blind, shutter, awning or venting louver positions

The feedback functions can be enabled and programmed independently for each output. When feedback is enabled, the ETS adapts the parameter texts depending on the preset operating mode ("Blind position feedback", "Shutter/awning position feedback" or "Venting louver position feedback"). The status feedback can be used as an active signalling object or as a passive status object. As an active signalling object, the position feedback

information is transmitted to the bus whenever a position value changes. As a passive status object, there is no telegram transmission after a change. In this case, the object value must be read out. The ETS automatically sets the object communication flags required for proper functioning.

In case of an actively transmitting signalling object, the current position can be transmitted to the bus after bus voltage return, if the position value differs from the one last transmitted. When the position data are known, the feedback telegram can in this case be transmitted with a time delay to reduce the bus load, with the delay being preset globally for all outputs in common (cf. "Delay after bus voltage return").

The feedback functions of an output must be enabled on parameter page "Ax – Enabled functions" (x = number of output). Only then are the parameters for the feedback functions visible.

- Set the parameter "Blind position feedback", "Shutter/awning position feedback" or "Venting louver position feedback" on parameter page "Ax – Feedbacks" to "feedback object is active signalling object".

The feedback object is enabled. The position value is transmitted as soon as it changes. No value will be actively transmitted, if the position is unknown.

- Set the parameter "Blind position feedback", "Shutter/awning position feedback" or "Rückmeldung Lüftungsklappenposition" on parameter page "Ax – Feedbacks" to "feedback object is passive status object".

The feedback object is enabled. The position value will be transmitted in response only if the feedback object is read out from by the bus. If the position is unknown, a value of "0" will be reported back after readout.

The feedback function must be preset as actively transmitting function.

- If a time delay after bus voltage return should be necessary, the parameter "Time delay for feedback after bus voltage return" on parameter page "Ax – Feedbacks" must be set to "yes".

The position is then reported back with a time delay after bus voltage return. After the end of the time delay, the position last adjusted statically will be transmitted to the bus. No feedback telegram will be transmitted during a running delay, even if a position value changes during this delay.

Presetting the position feedback for slat positions (only with blinds)

The feedback functions for the slat positions can be enabled and programmed independently for each output. The status feedback - like position feedback of the blind height - can be used as an active signalling object or as a passive status object.

In case of an actively transmitting signalling object, the current slat position can be transmitted to the bus after bus voltage return, if the position value differs from the one last transmitted. When the position data are known, the feedback telegram can in this case be transmitted with a time delay to reduce the bus load, with the delay being preset globally for all outputs in common (cf. "Delay after bus voltage return").

The feedback functions of an output must be enabled on parameter page "Ax – Enabled functions" (x = number of output). Only then are the parameters for the slat position feedback functions visible.

- Set the parameter "Slat position feedback" on parameter page "Ax – Feedbacks" to "feedback object is active signalling object".

The feedback object is enabled. The position value is transmitted as soon as it changes. No value will be actively transmitted, if the position is unknown.

- Set the parameter "Slat position feedback" on parameter page "Ax – Feedbacks" to "feedback object is passive status object".

The feedback object is enabled. The position value will be transmitted in response only if the feedback object is read out from by the bus. If the position is unknown, a value of "0" will be reported back after readout.

The feedback function must be preset as actively transmitting function.

- If a time delay after bus voltage return should be necessary, the parameter "Time delay for feedback after bus voltage return" on parameter page "Ax – Feedbacks" must be set to "yes".

The position is then reported back with a time delay after bus voltage return. After the end of the time delay, the position last adjusted statically will be transmitted to the bus. Although the feedback object concerned is updated during a running delay, no feedback telegram will, however, be actively transmitted during such delay, even if a position value changes during the delay.
- ❏ Behaviour of position feedback in case of voltage failure and voltage return:

When the bus voltage returns, with the mains voltage supply to the actuator being on, the current position data are always written into the feedback objects. The positions are transmitted to the bus also in those cases where the feedback objects are actively transmitting objects and where the position data differ from the data last reported back, for instance, as a result of manual control. If the position data are unknown, the feedback objects are initialized with "0" and are not transmitted to the bus. Without mains voltage supply, the connected drives are not activated so that there is always no position feedback, even after return of the bus voltage. In case of mains voltage return, the parameterized behaviour will be executed. The feedback objects are then updated provided the bus voltage is on.
- ❏ In case of blinds operation, any position change of the blind within the limits of the slat adjustment (0 to 100 %) does not launch a travel movement and therefore no change of the feedback position data either.

'Unknown position' feedback and travel movement

In addition to position data feedback, the blind actuator can also report back enlarged 1-bit status information messages and transmit them actively to the bus, if the bus voltage is on.

The following status feedback messages can be separately preset for each output...

- invalid position feedback message,
- drive movement feedback message.

Invalid position feedback message:

After switch-on of the supply voltage (bus and mains voltage failure) or after programming with the ETS, all position data of an output are unknown. In this case – when the bus voltage is on – the blind actuator can update the feedback object "Invalid position"(object value "1") which will then signal that the object values of the 1-byte position feedback objects are invalid.

An invalid position feedback will be only be reversed (object value "0") after the position data for the blind, shutter, awning or venting louver have been calibrated by means of a reference travel.

The calibration of the slat position in a blind alone will not result in the reversal of an 'invalid position' status message.

As an option, the object value of the status feedback message can be actively transmitted to the bus in case of a value change.

When the automatic end position detection is used, the actuator will generally report back an 'invalid position' until teaching of the travel time has been successful. The evaluation of a status feedback message can thus be used to distinguish a successful learning process.

Drive movement feedback message:

The blind actuator can report back via a separate 1-bit communication object per output whether the connected drive is moving, i.e. whether the output is supplying current for any of the travel directions. The feedback object has a value of "1" when current is flowing from the output to the drive. Likewise, a "0" is written into the object if the output concerned remains in a stop position. In this case, the operation by which the output was activated (short-time or long-time operation, positioning, manual control, etc.) is of no importance.

As an option, the object value of the status feedback message can be actively transmitted to the bus in case of a value change.

A mains voltage failure in the blind actuator always results in a "0" being written into the "Travel movement" feedback object. Moreover, the feedback status is derived exclusively from the relay state of the actuator. This means that if a drive is blocked or already in its end position, the value reported back does not correspond to the actual state of the travel movement.

Presetting an 'invalid position' feedback

The feedback for an invalid position can be enabled and programmed independently for each output. When feedback is enabled, the ETS adapts the parameter texts depending on the preset operating mode ("Invalid blind position feedback", "Invalid shutter/awning position feedback" or "Invalid venting louver position feedback").

The status feedback can be used as an active signalling object or as a passive status object. As an active signalling object, the status feedback information is transmitted to the bus whenever a position value changes. As a passive status object, there is no telegram transmission after a change. In this case, the object value must be read out. The ETS automatically sets the object communication flags required for proper functioning.

If the object is an actively transmitting signalling object, the feedback telegram can be transmitted after bus voltage return with a time delay to reduce the bus load, with the delay being preset globally for all outputs in common (cf. "Delay after bus voltage return").

The feedback functions of an output must be enabled on parameter page

"Ax – Enabled functions" (x = number of output). Only then are the parameters for the feedback functions visible.

- Set the parameter "Invalid blind position feedback", "Invalid shutter/awning position feedback" or "Invalid venting louver position feedback" on parameter page "Ax – Feedbacks" to "feedback object is active signalling object".

The feedback object is enabled. A telegram is transmitted as soon as there is a change (e.g. after ETS programming, after switch-on of the supply voltage or after a reference travel).

- Set the parameter "Invalid blind position feedback", "Invalid shutter/awning position feedback" or "Invalid venting louver position feedback" on parameter page "Ax – Feedbacks" to "feedback object is passive status object".

The feedback object is enabled. A telegram will be transmitted in response only if the feedback object is read out by the bus.

The feedback function must be preset as actively transmitting function.

- If a time delay after bus voltage return should be necessary, the parameter "Time delay for feedback after bus voltage return" on parameter page "Ax – Feedbacks" must be set to "yes".

An invalid position reported back with a time delay after bus voltage return. After the end of the time delay, the object value state last adjusted will be transmitted to the bus. No feedback telegram will be transmitted during a running delay. This is also the case if a position value becomes known, for instance, after a reference travel.

- i** Automatic transmission after bus voltage return will take place only if an internal change of the object state has occurred (caused, for instance, by a reference travel during manual control).

Presetting the travel movement feedback

The feedback messages can be enabled and programmed separately for each output. The status feedback can be used as an active signalling object or as a passive status object. As an active signalling object, the status feedback information is transmitted to the bus whenever a position value changes. As a passive status object, there is no telegram transmission after a change. In this case, the object value must be read out. The ETS automatically sets the object communication flags required for proper functioning.

If the object is an actively transmitting signalling object, the feedback telegram can be transmitted after bus voltage return with a time delay to reduce the bus load, with the delay being preset globally for all outputs in common (cf. "Delay after bus voltage return").

The feedback functions of an output must be enabled on parameter page

"Ax – Enabled functions" (x = number of output). Only then are the parameters for the feedback functions visible.

- Set the parameter "Travel movement feedback" on parameter page "Ax – Feedbacks" to "feedback object is active signalling object".

The feedback object is enabled. A telegram is transmitted when the connected drive starts moving or stops.

- Set the parameter "Travel movement feedback" on parameter page "Ax – Feedbacks" to "feedback object is passive status object".

The feedback object is enabled. A telegram representing the current travel movement will be transmitted in response only if the feedback object is read out by the bus.

The feedback function must be preset as actively transmitting function.

- If a time delay after bus voltage return should be necessary, the parameter "Time delay for feedback after bus voltage return" on parameter page "Ax – Feedbacks" must be set to "yes".

A travel movement feedback telegram is transmitted with a time delay after bus voltage return, for instance, when the drive is set in motion as a result of the preset behaviour after bus voltage return. After the end of the time delay, the object value state last adjusted will be transmitted to the bus. No feedback telegram will be transmitted during a running delay. This is also the case if the drive stops or starts moving during this delay.

- i** Automatic transmission after bus voltage return will take place only if the drive starts moving on return of bus voltage or if there has been a change of the travel movement caused by the bus failure.

Safety function

The blind actuator can handle up to five different safety functions:

3 x wind alarm, 1 x rain alarm, 1 x frost alarm. Each safety function has a communication object of its own so that the functions can be activated or deactivated independently of one another.

The safety functions are programmed and configured for all shutter/blind outputs together (cf. chapter "Description of channel-independent functions – Safety functions").

The different outputs of the actuator can be separately assigned to all or to individual safety functions. Only assigned outputs react to a change of state of the safety objects. The reactions at the beginning of an alarm ("1" telegram) can be parameterized for each alarm message separately whereas the reaction at the end of an alarm ("0" telegram) can be parameterized for all alarm messages in common (Figure 19).

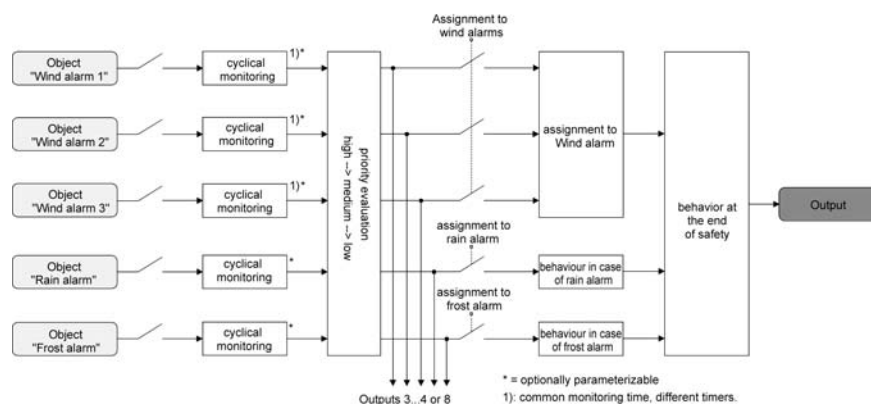

Figure 19: Function diagram of channel-oriented safety functions

An output can be assigned independently to the wind alarms, the rain alarm and the frost alarm. If an output is associated with several alarms, the preset priority decides which of the alarms will prevail and be executed. An alarm with a higher priority overrides the alarms with the lower priorities. When a safety alarm with the higher priority has ended, the safety alarm with the lower priority is executed on condition that it is active.

The order of priority of the wind alarms with respect to the frost alarm or to the rain alarm can be parameterized independent of the channel on the "Safety" parameter page. The three wind alarms have the same priority with respect to one another (logic OR). The last telegram update to the wind alarm objects decides which of the wind alarms will be executed. The wind alarm is completely deactivated only after all three objects are inactive ("0").

An output in the active safety alarm state is locked, i.e. the control of the output concerned via the bus by direct operation (short-time, long-time telegram, scenes, positioning, central) or by a sun protection function is prevented. Only a forced position and a manual control locally on the device itself have a higher priority so that these functions may override a safety interlock. At the end of a forced position or of a manual control, the safety reaction is re-executed if an assigned safety alarm is still active.

Assigning safety alarms

The individual safety alarms can be assigned separately to each output. The channels are assigned on parameter page "Ax – Safety" (x = number of output).

The safety functions must be globally enabled on the "Safety" parameter page before the output assignments are configured.

The safety function for an output must be enabled on parameter page "Ax – Enabled functions (x = number of output). Only then are the channel-related parameters for the safety function visible.

- If an assignment to the wind alarms is necessary, set the parameter "Assignment to wind alarms" to the wind alarm or the wind alarms required.
The output is assigned to the specified wind alarms.
- If an assignment to the rain alarm is necessary, set the parameter "Assignment to rain alarm" to "yes".
The output is assigned to the rain alarm.
- If an assignment to the frost alarm is necessary, set the parameter "Assignment to frost alarm" to "yes".
The output is assigned to the frost alarm.

i If an output is assigned to an alarm which is not globally enabled, the assignment is without effect.

i Important information about the activation or deactivation of a safety alarm, about the presetting of the priority and about cyclical monitoring can be found in chapter "Channel-independent functional description – Safety functions".

Presetting the behaviour at the beginning of a safety alarm

The behaviour of an output at the beginning of a safety alarm can be parameterized separately for each alarm (wind alarms in common, rain and frost alarms separately). The alarm behaviour is preset on parameter page "Ax – Safety" (x = number of output). At the beginning of a safety alarm, the actuator locks the outputs concerned, i.e. control via the bus by direct operation or by a sun protection function is prevented.

Depending on the selected mode of operation, the ETS adapts the designations of the parameter settings ("raising" ↔ "opening the louver" / "lowering" ↔ "closing the louver").

The safety functions must be globally enabled on the "Safety" parameter page.

The safety function for an output must be enabled on parameter page "Ax – Enabled functions (x = number of output). Only then are the channel-related parameters for the safety function visible.

The behaviour in case of a safety alarm can only be adjusted, if the output concerned has been assigned to the corresponding alarm. Since there is no difference between the alarm-dependent parameterizations, the selection of the parameters is described below only once.

- Set the parameter "Behaviour in case of ..." to "no reaction".
At the beginning of the alarm, the output is locked and the relay of the output shows no reaction. Any travel movements still in progress at this instant will still be completely finished.
- Set the parameter "Behaviour in case of ..." to "raising" or "opening the louver".

The actuator raises the curtain or opens the venting louver at the beginning of the alarm and locks the output thereafter.

- Set the parameter "Behaviour in case of ..." to "lowering" or "closing the louver".

The actuator lowers the curtain or closes the venting louver at the beginning of the alarm and locks the output thereafter.

- Set the parameter "Behaviour in case of ..." to "stop".

At the beginning of the alarm, the actuator switches the relays of the output to "stop" and locks the output. A travel movement, if any, will be interrupted.

- i** The safety travel time required by an output to move the drive into the end positions is determined by the "Travel time" parameter on parameter page "Ax - Time settings" or by the travel time learnt in case of automatic end position detection. Like the long-time operation, a safety travel is derived from the travel time. Downward travel: travel time + 20 %; Upward travel: travel time + 20 % + parameterized or taught-in travel time extension. Safety travels are not retriggerable.

- i** Slats of blinds are not repositioned at the end of safety travels into end positions.

Presetting the behaviour at the end of all safety alarms

The blind actuator ends the safety interlock of an output only after all safety alarms assigned to the output have become inactive. Thereafter, the output concerned shows the parameterized "Behaviour at the end of safety". The behaviour is parameterized in common for all alarms on parameter page "Ax – Forced position" (x = number of output).

Depending on the selected mode of operation, the ETS adapts the designations of the parameter settings ("raising" ↔ "opening the louver" / "lowering" ↔ "closing the louver").

The safety functions must be globally enabled on the "Safety" parameter page.

The safety function for an output must be enabled on parameter page

"Ax – Enabled functions" (x = number of output). Only then are the channel-related parameters for the safety function visible.

- Set the parameter "Behaviour at the end of safety" to "no reaction".

At the end of all safety alarms, the output is released and the relay of the output shows no reaction. Any travel movements still in progress at this instant will still be finished.

- Set the parameter "Behaviour at the end of safety" to "raising" or "opening the louver".

The actuator releases the output at the end of all safety alarms and raises the curtain or opens the venting louver.

- Set the parameter "Behaviour at the end of safety" to "lowering" or "closing the louver".

The actuator releases the output at the end of all safety alarms and lowers or closes the venting louver.

- Set the parameter "Behaviour at the end of safety" to "stop".

At the end of all safety alarms, the output is released and the actuator switches the relays of the output to "stop". A travel movement, if any, will be interrupted.

- Set the parameter "Behaviour at the end of safety" to "tracking the position".

At the end of all safety alarms, the output will be set to the state last adjusted statically before the safety function or to the state tracked and internally stored during the safety function. The position objects, the long-time object and the scene function are tracked.

- i** Parameter setting "Position tracking": The blind actuator can track absolute positions after safety release (position telegram, scene value) only if the position data are known and if the positions have been predefined. In all other cases, no reaction takes place on release of safety.

Position data can be tracked, if the output was in a defined position before the safety function or if a new position telegram was received via the position objects during the safety interlock. In the latter case, a reference travel will be executed when the safety function is enabled, if the position before or during the safety interlock was unknown. Known slat positions will also be tracked as described. This is also the case, when the height of the blind is unknown.

Long-time travel movements (travels without position preset) will, however, always be tracked.

- i** The preset "Behaviour at the end of safety" will only be executed, if the output passes over to direct operation at the end of all safety alarms. If a sun protection function is activated (independent of the preset priority with respect to direct operation), it will be also executed.

Sun protection function - General information

Each output of the blind actuator can be separately configured for the execution of a sun protection function. Sun protection is generally realized with blinds, shutters or awnings and offers an intelligent method of shading rooms, terraces or balconies during sunshine depending on the altitude of the sun in the sky and on the intensity of the sunlight (Figure 20)

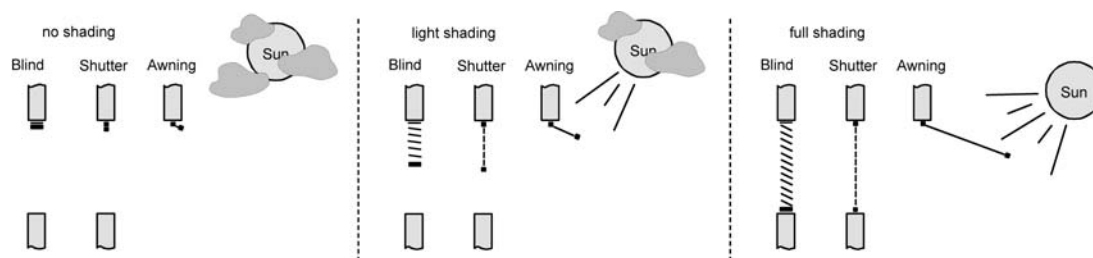

Figure 20: Sun protection principles (example)

The sun protection functions of the blind actuator can be adapted many different applications. In simple applications as, for instance, in case of direction-dependent measurement of the sun's intensity by means of a brightness sensor, the curtains controlled can be closed partly or completely to prevent being disturbed by direct sunlight. In these applications, the sun protection function merely evaluates the 1-bit sun signal from the brightness or a similar sensor (e.g. weather station with limit value monitoring) and makes a drive open or close the controlled curtains by moving them into fixed parameterized positions or into variable positions preset via the bus.

In extended applications – for instance where the degree of shading is controlled by weather stations evaluating additionally the sun angle as a function of astro coordinates and presetting the blind and also the slat positions dynamically – the sun protection function can be supplemented by an automatic control system. In such applications, the sun protection function evaluates additional bus communication objects allowing to enable or to disable the automatic control while the blind actuator is in operation. This results in a large number of combination variants with intelligent blind/shutter control systems.

Already simple sun protection applications are sufficient to permit a fixed or variable re-adjustment of the positions of blind slats for adapting the curtain to individual shading requirements. For such purpose, it is possible to preset a static slat offset in the ETS parameters, for instance, for adapting the reflection of sunlight depending on the building situation, or additionally, a dynamical slat offset via a bus communication object, for instance, for manual re-adjustment of the slat opening by persons in the room or otherwise by a central building services control system.

In all cases, the priority between an incoming sunshine or automatic telegram and the direct operation of an output (short-time, long-time telegram, scenes, positioning, central) is also

presetable in the ETS. This way, a sun protection position can, for instance, be influenced by a 'manual' operation of a touch sensor in the room and the sun protection function be interrupted. Alternatively, the protection function cannot be interrupted by a direct operation. i.e. the output is interlocked.

A sun protection function can be overridden by a safety function, a forced position or also by a manual control locally on the device itself as these functions of the blind actuator invariably have a higher priority. At the end of one of the mentioned functions with a higher priority, the same reaction as the one at the beginning of sun protection will be re-executed, if the sun protection function is still active at this time.

The blind actuator can be operated with two sun protection functions. The simple sun protection or alternatively the enlarged sun protection that can be enabled.

Sun protection function - Simple sun protection

In the simple sun protection, shading against sunlight is activated and deactivated via the 1-bit communication object "Sunshine / shading facade". The polarity of this object can be selected in the ETS. The sun protection is activated as soon as "sunshine" is signalled to the object depending on the preset polarity. After ETS programming or after switch-on of the supply voltage, the object must at first have data written into it by the bus also in case of inverted polarity before the sun protection can be activated.

A newly received object value (sun / beginning of shading or sun / end of shading) can optionally be evaluated with a time delay. This feature permits suppressing brief brightness variations caused, for instance, by passing clouds or by a thunderstorm. An update (from deactivated to activated) of the "Sunshine / shading facade" object causes the sun protection to be reactivated, if it had been influenced and possibly been re-enabled beforehand by a direct operation in acc. with the preset priority.

The reaction of a specific output at the beginning of shading can be preset in the ETS. This setting permits approaching fixed parameterized positions or positions preset via the bus and thus variable. Variable positions for sun protection purposes can be preset, for instance, by means of touch sensors or visualizations. In addition, it is possible in case of a defined sun protection positioning movement to have a reference travel executed by forced control. This ensures that identical curtain positions are approached synchronously by different outputs in case of a sun protection positioning movement.

The reaction at the end of a shading task can be preset as well. In this situation, the curtain can pass into an end position, be stopped or shown no special reaction. Tracking of positions is possible as well.

By means of a priority setting in the ETS parameters it can be specified whether the sun protection function can be influenced by operation or whether the corresponding output is locked by a telegram "Sunshine / shading facade" in the sun protection position. Basically, the "Manual control", "Forced position" and "Safety" functions have a higher priority so that these functions can override, but not terminate a sun protection. Thus, the sun protection function is re-executed at the end of a function with a higher priority, if the object "Sunshine / shading facade" continues to signal the presence of sunshine.

- i** The following rules must be observed for the enlarged sun protection: After an ETS programming operation, the sun protection function including automatic operation is always deactivated. An activated sun protection (independent of the selected priority with respect to direct operation) remains active even after a bus voltage failure as long as the mains voltage supply is still on. The sun protection reaction last executed will therefore be executed again at the end of a temporary or permanent manual control (if enabled in case of bus failure), even if there is no bus voltage.

The schematic diagram of the simple sun protection (Figure 21) and an example of how sensor components can be integrated into a simple sun protection configuration.

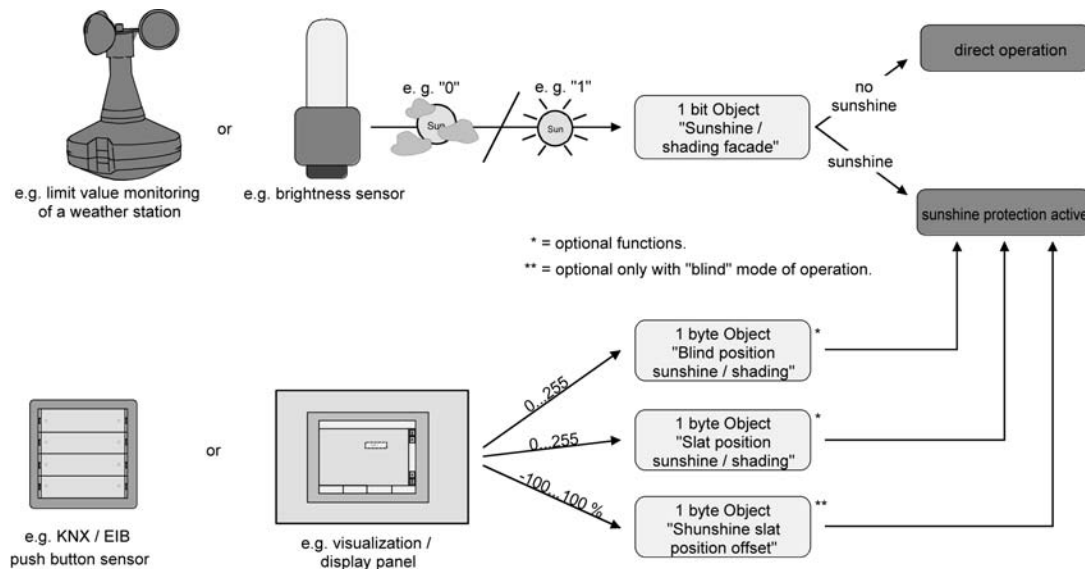

Figure 21: Schematic diagram illustrating the simple sun protection configuration

The function diagram (Figure 22) shows all possible functions of the simple sun protection. For reasons of clarity, the functions with a higher priority (manual control, forced position, safety function) are not shown in the diagram.

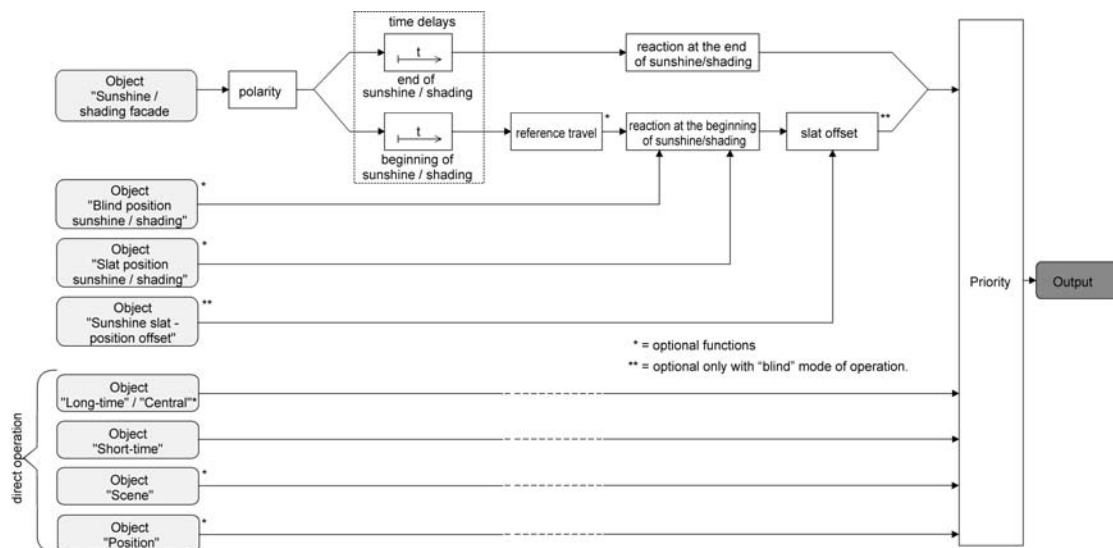

Figure 22: Function diagram illustrating the simple sun protection

Sun protection function - Extended sun protection

The extended sun protection has the basic functional properties of the simple sun protection function. In addition, an automatic control system can be implemented. Venetian blind control systems for blind and slat position tracking with respect to the position of the sun as, for instance, a weather station with combination sensor can therefore be integrated into the Venetian blind actuator system via the bus as an added automatic function.

In the extended sun protection, shading against sunlight is activated and deactivated via the 1-bit communication object "Sunshine / shading facade". A reaction of the output to the sun telegram can be expected only after the automatic control has been activated. In all other cases, the sun protection function is completely deactivated.

As far as the activation of the automatic control via the corresponding object is concerned, the following two cases must be distinguished...

- Sun shading action starting immediately:
Automatic operation is activated as soon as the Object 15 "Automatic" receives a "1" telegram. The output reacts immediately to the activation and shows the preset behaviour depending on sunlight conditions (Sun / beginning of the shading action / Sun end of the shading action). The sunlight conditions are derived from the "Sun / shading facade" object according to the set polarity - if necessary after the delays have elapsed.
After an ETS programming operation or after switch-on of the supply voltage, the "Sunshine / shading facade" object is initialised with "0" and, unlike the simple sun protection, evaluated immediately depending on the preset polarity so that shading against sunlight can begin immediately on activation of the automatic sun protection function. The reception of a "0" telegram by the object "Automatic" always terminates an automatic operation independent of the state of the "Sunshine / shading facade" object.

Application example:

Private house with conservatory. The conservatory is equipped with Venetian blinds to shade the place against sunlight. When the conservatory is used, automatic operation is activated, for instance, with a pushbutton sensor on the wall. The Venetian blind actuator then carries out the shading operation immediately if sunshine was previously detected. The actuator then carries out the configured behaviour at the end of Sunshine / Shading, if no sunshine was detected on activating Automatic operation.

- Activation of the sun shading only on the next update:
In this configuration, the polarity of the automatic object can be preset. The automatic operation is activated as soon as object 16 "Automatic" is set to 'active' in consideration of polarity. A reaction at the output occurs, however, only after a new change of state ("0"-">"1" or "1" -> "0") has been signalled via the "Sunshine / shading facade" object. In this case, the new state (beginning of sunshine/shading or end of sunshine/shading) determines the behaviour of the output immediately depending on the preset polarity. After an ETS programming operation or after switch-on of the supply voltage, the object "Automatic" must at first have data written into it by the bus also in case of inverted polarity before the automatic operation can be activated.
The reception of an 'Automatic deactivated' telegram by the "Automatic" object always terminates an automatic operation independent of the state of the "Sunshine / shading facade" object.

Application example:

An office building is equipped with several Venetian blinds to shade individual offices against sunlight. In the early morning hours, the automatic sun protection is activated in a central place in the building, e.g. in the porter's lodge. The Venetian blinds will, however, not move into the shading positions unless the system has actually reported sunshine for the building facades in question.

The behaviour at the end of automatic operation is configured separately in the ETS and is executed whenever the automatic mode is terminated and when no function with a higher priority is active at this time. In this situation, the blind can pass into an end position, be stopped or shown no special reaction. Tracking of positions is possible as well.

Disabling functions of the extended sun protection:

In the event of the sun shading action starting immediately, the automatic operation can optionally be disabled with an additional communication object. The objects "Automatic" and "Automatic mode disable" are logically combined (AND with feedback). When disabling is activated, the automatic operation is reset and thus aborted. The output concerned will then show the behaviour at the end of automatic operation. The automatic mode can only be reactivated if the disabling object is released and if object 15 "Automatic" is updated again by writing a "1" into it. Any attempt to activate the automatic mode while a disable is active will be ignored.

Automatic operation disabling example:

An office room is equipped with Venetian blinds to shade the room against sunlight. The room is moreover equipped with a pushbutton sensor on the wall with which the automatic operation can be activated or also deactivated. When the automatic mode is activated, the room is immediately shaded against sunlight, if necessary. Depending on the time of day or in the event of disturbing sunlight falling into the room, the people in the room can therefore decide for themselves whether automatic shading is desired or not.

If required, the automatic sun protection is disabled in a central place of the building, for instance, in the porter's lodge. The automatic control of the Venetian blinds can then be deactivated, if servicing work is being carried out (window cleaning or similar work). After the end of disabling, for instance, at the end of the working hours, automatic operation can only be restarted if it is reactivated in any of the rooms in case of need.

In addition, also the direct operation of an output can be disabled with an independent disabling object. When disabling is active, a direct operation can – independently of the preset priority – never override a sun protection function. In this case, direct operation is non operational in other functions, too. During disabling, incoming direct operation telegrams are completely ignored (positions received via the bus can then not be tracked either).

If the disabling command is received while a movement initiated by direct operation is in progress, the movement will still be completely finished. Thereafter, direct operation is disabled.

Direct operation disabling example:

An office building is equipped with several Venetian blinds to shade individual offices against sunlight. During the working hours, the rooms are to be shaded automatically. Any direct operation – e.g. by means of a simple Venetian blind pushbutton sensor on the wall – is to be disabled during the day. For this reason, the direct operation is disabled, for instance, by the porter or by a building services management system. Cleaners must have the possibility of controlling the Venetian blinds directly only after the normal working hours. In this case, direct operation can again be centrally enabled during evening and night hours.

The disabling functions for automatic and for direct operation can also be combined so that it is possible to intervene at any time and as required by the situation in sun protection control functions.

Sunshine signal in the extended sun protection mode:

In the sun protection mode, the system is informed about the prevailing sunshine conditions via the "Sunshine / shading facade" communication object. The system then decides whether shading is required or not. In the extended sun protection mode, the sunshine signal is only evaluated when the automatic operation is activated as well.

A new value received via the "Sunshine / shading facade" object can optionally be evaluated with a time delay. This feature permits suppressing brief brightness variations caused, for instance, by passing clouds or by a thunderstorm. The time delay is started after an update of the "Sunshine / shading facade" object also in those cases where the automatic operation is deactivated so that the newly received information about the sunshine conditions may possibly also be processed with a delay, if the automatic operation is activated later on.

Unlike in the simple sun protection mode, an update of the "Sunshine / shading facade" object from active to active or from inactive to inactive in the extended sun protection mode shows generally no reaction. The behaviour of the output is only influenced if a change of state is being detected. An update of the sunshine signal alone does not result in the activation of the automatic operation either.

When the automatic operation is active, the reaction of a specific output at the beginning of shading can be preset separately in the ETS. This setting permits, amongst other things, approaching fixed configured positions or positions preset via the bus and thus variable. Positions for sun protection purposes can be variably preset, for instance, by means of a weather station for sun position tracking.

In addition, it is possible in case of a defined sun protection positioning movement to have a reference movement executed by forced control. This ensures that identical blind positions are approached synchronously by different outputs in case of a sun protection positioning

movement.

At the end of sun shading in active Automatic operation, the reaction of an output can also be configured separately. In this case, too, it is possible, amongst other things, to approach fixed configured positions.

By means of a priority setting in the ETS parameters it can be specified whether the evaluation of the sunshine signal in the automatic mode can be influenced by a direct operation or whether the automatic mode basically locks the corresponding output during sun protection. The "Manual control", "Forced position" and "Safety" functions invariably have a higher priority so that these functions can override, but not terminate a sun protection including an automatic operation. Thus, the sun protection function is re-executed at the end of a function with a higher priority, if the automatic sunshine protection is still active.

An update (from activated to activated) of the "Automatic" object causes the sun protection to be reactivated, if it had been influenced and cancelled beforehand by a direct operation in accordance with the lower priority.

The schematic diagram of the extended sun protection (Figure 23) and an example of how sensor components can be integrated into an extended sun protection configuration.

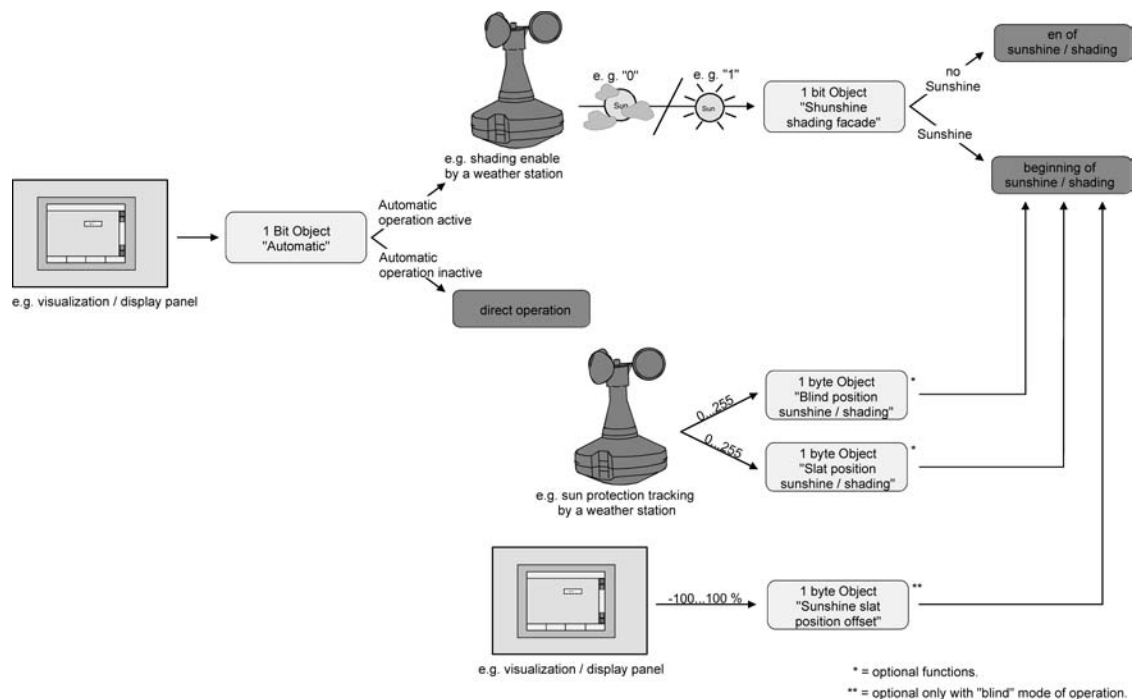

Figure 23: Schematic diagram illustrating the extended sun protection configuration (for reasons of simplicity without disabling functions)

The function diagram (Figure 24) shows all possible functions of the extended sun protection. For reasons of clarity, the functions with a higher priority (manual control, forced position, safety function) are not shown in the diagram.

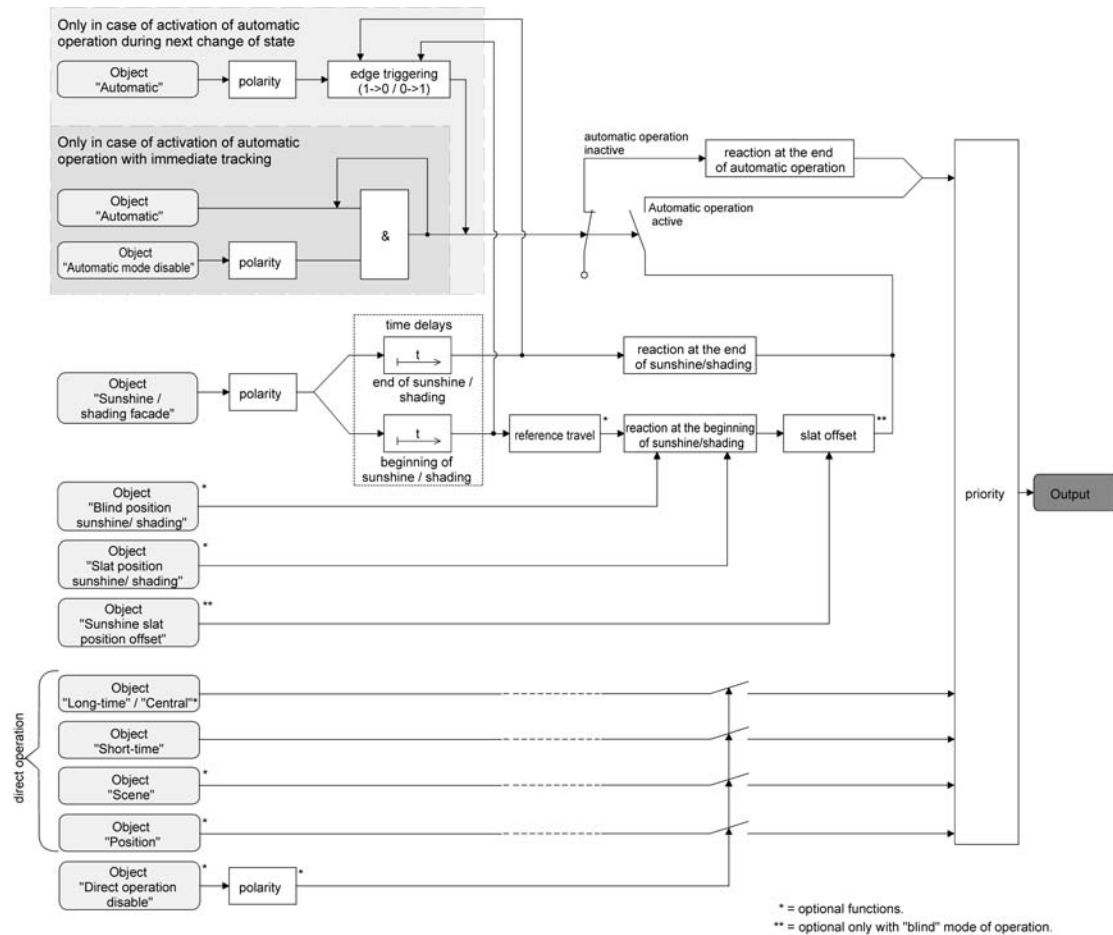

Figure 24: Function diagram illustrating the extended sun protection

- i** The following rules must be observed for the extended sun protection:
- After an ETS programming operation, the sun protection function including automatic operation is always deactivated. Activated sun protection (independent of the selected priority with respect to direct operation) remains active even after a bus voltage failure as long as the mains voltage supply is still on. The sun protection reaction last executed will therefore be executed again at the end of a temporary or permanent manual control (if enabled in case of bus failure), even if there is no bus voltage.

Presetting the type of sun protection

The type of sun protection can be preset separately for each output. The setting determines whether the simple or the enlarged type of sun protection is configured.

For the sun protection parameters to be visible, the sun protection function must be enabled on parameter page "Ax – Enabled functions (x = number of output).

- Set the parameter "Type of sun protection" on parameter page "Ax – Sun protection" to "simple sun protection".
Simple sun protection is now configured. The necessary parameters and communication objects are visible.
- Set the parameter "Type of sun protection" on parameter page "Ax – Sun protection" to "enlarged sun protection".
Enlarged sun protection is now configured. The necessary parameters and communication objects are visible.

- i** When the sun protection type parameters are changed, the assignments of group addresses to sun protection objects or other parameter settings are lost. For this reason, the sun protection type parameter should be selected directly at the beginning of the sun protection parameterization and then not be changed anymore later on.

Presetting the priority of sun protection (for simple sun protection only)

The priority of the sun protection function can be set separately for each output. In the simple sun protection, the priority relations between the "Sunshine / shading facade" object and the objects of direct operation (short-time, long-time, central or position telegram, scene recall) must be configured.

For the sun protection parameters to be visible, the sun protection function must be enabled on parameter page "Ax – Enabled functions (x = number of output).

The function must have been configured for simple sun protection.

- Set the parameter "Priority of sun protection with respect to direct operation" on parameter page "Ax Sun protection" to "same priority".

The sun protection mode can be overridden at any time by direct operation. In the same way, the sun protection overrides the direct operation, when a new "sunshine" telegram is received via the "Sunshine / shading facade" object and when a parameterized time delay, if any, has elapsed. If the sun protection function is overridden by a direct operation, the preset behaviour "Reaction at the end of sunshine / shading" will not be executed.

- Set the parameter "Priority of sun protection with respect to direct operation" on parameter page "Ax Sun protection" to "higher priority".

An active sun protection will override a direct operation. The sun protection mode can therefore not be interrupted by a direct operation. Direct operation will be possible again only after the sun protection function is terminated.

- Set the parameter "Priority of sun protection with respect to direct operation" on parameter page "Ax Sun protection" to "lower priority".

A direct operation can at any time override the sun protection mode. If the sun protection function is overridden by a direct operation, the preset behaviour "Reaction at the end of sunshine / shading" will not be executed. The sun protection function can only be reactivated after an enabling movement controlled by a direct operation has been effected and after a new "sunshine" telegram has been received via the "Sunshine / shading facade" object. If the enabling movement has not yet occurred, any attempt to activate the sun protection will be disregarded.

Enabling movement:

An enabling movement is an accomplished long-time travel movement into the upper end position which has been initiated by the objects "Long-time operation" or "Central travel control". A manual control, an upward travel movement after bus voltage failure or bus voltage return, a position approach to "0 %" or an upward travel movement after releasing enabling of forced-position or safety functions have no enabling effect. The sun protection is not enabled if the enabling movement has been interrupted. The sun protection function will be also be interlocked, if the output has been re-adjusted again by a direct operation after an accomplished enabling movement.

After an ETS programming operation or after switch-on of the supply voltage (bus and mains voltage) the sun protection function is generally enabled.

- i** Manual local operation on the device itself, the forced position function and the safety functions have a fixed priority higher than that of the sun protection. The sun protection is overridden – but not terminated – by a function with a higher priority. After the end of the function with the higher priority the reaction at the beginning of sun protection will therefore be executed again, if the sun protection is still active at this time.

- i** With the settings "same priority" or "lower priority", the sun protection can be overridden by a direct operation only if the direct control action can be executed at once. A direct operation will therefore not override the sun protection during a manual control locally on the device, an active forced position function or an active safety function.

- i** Parameter setting "same priority" or "lower priority": A variable preset of curtain and slat positions or of a slat offset via the bus at the beginning of sunshine / shading shows no reaction at the output, if the sun protection was overridden by direct operation. However, the position data or offsets received are stored internally so that the new positions will be approached on reactivation of the sun protection.

Presetting the priority of automatic sun protection (for enlarged sun protection only)

The priority of the automatic sun protection function can be set separately for each output. In the enlarged sun protection, the priority relations between the "Sunshine / shading facade" object and the objects of direct operation (short-time, long-time, central or position telegram, scene recall) must be configured. The selected priority thus affects the evaluation of the sunshine signal in the automatic mode and not the automatic mode itself.

For the sun protection parameters to be visible, the sun protection function must be enabled on parameter page "Ax – Enabled functions (x = number of output)".

The function must have been configured for enlarged sun protection.

- Set the parameter "Priority of automatic operation with respect to direct operation" on parameter page "Ax Sun protection" to "same priority".

The sunshine signal of the automatic sun protection mode and the corresponding reaction can be overridden at any time by direct operation. In the same way, the sunshine signal overrides the direct operation, when a new "sunshine" or "no sunshine" telegram is received via the "Sunshine / shading facade" object and when this telegram results in a change of state. Moreover, a parameterized delay time, if any, must have elapsed. When the sunshine signal is overridden by a direct operation, the preset behaviour "Reaction at the end of sunshine / shading" will not be executed.

- Set the parameter "Priority of automatic operation with respect to direct operation" on parameter page "Ax Sun protection" to "higher priority".

An active automatic mode always overrides the direct operation independent of the sunshine signal. The sunshine signal can therefore not be interrupted by a direct operation. Direct operation will be possible again only after the automatic mode is terminated.

- Set the parameter "Priority of automatic operation with respect to direct operation" on parameter page "Ax Sun protection" to "lower priority".

A direct operation can at any time override the sunshine signal. If the sunshine signal is overridden, the preset behaviour "Reaction at the end of sunshine / shading" will not be executed. The sunshine signal will be evaluated again only after an enabling movement controlled by a direct operation has been effected and when a new "sunshine" or "no sunshine" telegram is received via the "Sunshine / shading facade" object and when this telegram results in a change of state. The sunshine signal is ignored until the enabling movement is accomplished.

Enabling movement:

An enabling movement is an accomplished long-time travel movement into the upper end position which has been initiated by the objects "Long-time operation" or "Central travel control". A manual control, an upward travel movement after bus voltage failure or bus voltage return, a position approach to "0 %" or an upward travel movement after releasing enabling of forced-position or safety functions have no enabling effect. The sunshine signal is not enabled if the enabling movement has been interrupted. The sunshine signal will be also be interlocked, if the output has been re-adjusted again by a direct operation after an accomplished enabling movement.

- i** A direct operation never terminates the automatic mode. Irrespective of a function being overridden by a direct operation, an activation or a deactivation of the automatic mode (telegram update of the "Automatic" object) always re-enables the sunshine signal as well and evaluates it when the automatic mode is active. Attention must be paid to this behaviour especially in those cases where the "Automatic" object is cyclically overwritten by telegrams.

- i** Manual local operation on the device, the forced position function and the safety functions have a fixed priority higher than that of the automatic sun protection. The sun protection is overridden – but not terminated – by a function with a higher priority. After the end of the function with the higher priority the reaction last executed by the automatic sun protection will therefore be executed again, if the sun protection is still active at this time.
- i** With the settings "same priority" or "lower priority", the sunshine signal can be overridden by a direct operation only if the direct control action can be executed at once. A direct operation will therefore not override the sunshine signal during a manual control locally on the device, an active forced position function or an active safety function.
- i** Parameter setting "same priority" or "lower priority": A variable preset of curtain and slat positions or of a slat offset via the bus at the beginning of sunshine / shading shows no reaction at the output, if the sunshine signal was overridden by direct operation. However, the position data or offsets received are stored internally so that the new positions can be approached when the sensor signals that the sun is shining again.
- i** Irrespective of the preset priority, an update of the "Sunshine / shading facade" object from active to active or from inactive to inactive in the enlarged sun protection mode shows generally no reaction. The behaviour of the output is only influenced if a change of state is being detected.

Presetting the polarity of the "Sunshine / shading facade" object

The telegram polarity of the "Sunshine / shading facade" object can be preset separately for each output. This means that an adaptation to the signals from existing sensors or weather stations is possible in the simple and also in the enlarged sun protection mode.

For the sun protection parameters to be visible, the sun protection function must be enabled on parameter page "Ax – Enabled functions (x = number of output).

- Set the parameter "Polarity of 'Sunshine / shading facade' object" on parameter page "Ax Sun protection" to the required telegram polarity.

The sunshine signal is evaluated in accordance with the preset priority.

- i** In the simple sun protection mode, an update (from activated to activated) of the "Sunshine / shading facade" object causes the sun protection to be reactivated, if it had been influenced and possibly been re-enabled beforehand by a direct operation in acc. with the preset priority.
- i** In the enlarged sun protection mode, an update of the "Sunshine / shading facade" object from active to active or from inactive to inactive shows generally no reaction. The behaviour of the output is only influenced if a change of state is being detected.

Presetting the activation of the automatic mode (for enlarged sun protection only)

As far as the activation of the automatic mode is concerned, two cases must be distinguished which can be configured with the help of ETS parameters separately for each output. Either a travel movement in acc. with the reaction at the beginning or the end of sunshine is executed immediately on activation of the automatic mode, or otherwise the system waits after activation of the automatic mode for a new change of state in the "Sunshine / shading facade" object until the corresponding output shows the reaction at the beginning or at the end of sunshine.

For the sun protection parameters to be visible, the sun protection function must be enabled on parameter page "Ax – Enabled functions (x = number of output).

The function must have been configured for enlarged sun protection.

- Set the parameter "Activation of automatic mode by..." on parameter page "Ax Sun protection" to "object 'Automatic' and next change of state".

Automatic operation is activated as soon as the "Automatic" object is set to 'active' in consideration of polarity. A reaction at the output occurs, however, only after a new change of state has been signalled via the "Sunshine / shading facade" object. In this case, the new state (beginning of sunshine/shading or end of sunshine/shading) determines the behaviour of the output.

- Set the parameter "Activation of automatic mode by..." on parameter page "Ax Sun protection" to "object 'Automatic' & immediate tracking".

Automatic operation is activated as soon as object "Automatic" receives a "1" telegram. The behaviour of the output (beginning of sunshine/shading or end of sunshine/shading) is immediately determined by the state of the object "Sunshine / shading facade".

- i** Depending on the selected setting, the "Automatic" object either has object no. 15 or 16. In case of re-parameterization the assignments of group addresses to the automatic object is lost.

Presetting the polarity of the "Automatic" object (for enlarged sun protection only)

If the automatic mode is to be activated via the object and only at the next change of state of the sunshine signal (see "Presetting the activation of the automatic mode"), the telegram polarity of the automatic object can be preset in addition.

For the sun protection parameters to be visible, the sun protection function must be enabled on parameter page "Ax – Enabled functions (x = number of output)".

The enlarged sun protection must be configured for activation of the automatic mode on next change of state.

- Set the parameter "Polarity of 'Heating/cooling change-over' object" on parameter page "Ax Sun protection" to the required telegram polarity.
The telegram to the "Automatic" object will be evaluated depending on the selected priority.

- i** After an ETS programming operation or after switch-on of the supply voltage, the object "Automatic" must at first have data written into it by the bus also in case of inverted polarity before the automatic operation can be activated.

- i** The polarity of the "automatic" object is not presettable, if the automatic mode is activated via the object with immediate tracking. In this case, the telegram polarity is fixed: Automatic ON = "1", Automatic OFF = "0".

Presetting the disabling function for the automatic mode (for enlarged sun protection only)

The automatic mode can be deactivated at any time via a separate disabling object. After enabling of the disabling function in the ETS parameters, the "Automatic mode disable" object becomes visible.

For the sun protection parameters to be visible, the sun protection function must be enabled on parameter page "Ax – Enabled functions (x = number of output)".

The enlarged sun protection must be configured for activation of the automatic mode with immediate tracking of the sunshine signal.

- Set the parameter "Disabling function for automatic mode ?" on parameter page "Ax Sun protection" to "yes".
The disabling function is enabled. The parameter for setting of the polarity becomes visible.
- Set the parameter "Polarity of object 'Automatic mode disable'" on parameter page "Ax Sun protection" to the required telegram polarity.
The telegram to the "Automatic mode disable" object will be evaluated depending on the selected priority.

- i** The objects "Automatic" and "Automatic mode disable" are logically combined (AND with feedback). When disabling is activated, the automatic operation is reset and thus aborted. The output concerned will then show the behaviour at the end of automatic operation. The automatic mode can only be reactivated, if the disabling object is released and if object 15 is updated again by writing a "1" into it. Any attempt of activating the automatic mode while a disable is active will be ignored.

- i** After an ETS programming operation or after switch-on of the supply voltage, the objects "Automatic" and "Automatic mode disable" are always initialized with "0". If the disabling object works with inverted polarity (setting "disabled" = "0") the disabling function is in this case immediately active. A bus voltage failure while the mains voltage is present has no effect on the state of the disabling object.

Presetting the disabling function for direct operation (for enlarged sun protection only)

The direct mode can be deactivated at any time via a separate disabling object. After enabling of the disabling function in the ETS parameters, the "Direct operation disable" object becomes visible.

For the sun protection parameters to be visible, the sun protection function must be enabled on parameter page "Ax – Enabled functions (x = number of output)".

The function must have been configured for enlarged sun protection.

- Set the parameter "Disabling function for direct mode ?" on parameter page "Ax Sun protection" to "yes".
The disabling function is enabled. The parameter for setting of the polarity becomes visible.
- Set the parameter "Polarity of object 'Direct operation disable'" on parameter page "Ax Sun protection" to the required telegram polarity.
The telegram to the "Direct operation disable" object will be evaluated depending on the selected priority.

- i** After an ETS programming operation or after switch-on of the supply voltage, the "Automatic mode disable" object is always initialized with "0". If the disabling object works with inverted polarity (setting "disabled" = "0") the disabling function is in this case immediately active. A bus voltage failure while the mains voltage is present has no effect on the state of the disabling object.

Presetting the reaction at the end of automatic operation (for enlarged sun protection only)

When the automatic operation is being deactivated – also by the disabling function – the output concerned will show the preset reaction, if no function with a higher priority is active at the time of deactivation. The preset reaction will not be executed either on termination of the automatic operation, if the sunshine signal is overridden on account of priority settings by a direct operation. The reaction at the end of automatic operation is preset on parameter page "Ax – Sun protection" (x = number of output). Depending on the selected mode of operation, the ETS adapts the designations of the parameter settings ("raising" ↔ "opening the louver" / "lowering" ↔ "closing the louver").

For the sun protection parameters to be visible, the sun protection function must be enabled on parameter page "Ax – Enabled functions (x = number of output)".

The function must have been configured for enlarged sun protection.

- Set the parameter "Reaction at the end of automatic operation" to "no reaction".
At the end of automatic operation the relay of the output shows no reaction. Any travel movements still in progress at this instant will still be finished.
- Set the parameter "Reaction at the end of automatic operation" to "raising" or "opening the louver".
At the end of automatic operation, the actuator raises the curtain or opens the venting louver.
- Set the parameter "Reaction at the end of automatic operation" to "lowering" or "closing the louver".
At the end of automatic operation, the actuator lowers the curtain or closes the venting louver.

- Set the parameter "Reaction at the end of automatic operation" to "stop".
At the end of automatic operation, the actuator switches the relays of the output to the "stop" position. A travel movement, if any, will be interrupted.
 - Set the parameter "Reaction at the end of automatic operation" to "position tracking".
At the end of automatic operation, the output will be set to the state last adjusted statically before the automatic sun protection or to the state tracked and internally stored during the automatic sun protection. The position objects, the long-time object and the scene function are tracked.
- i** The behaviour preset in this parameter will only be executed, if no function with a higher priority (e.g. safety) is activated at the end of automatic operation.
- i** Parameter setting "Position tracking": The blind actuator can track absolute positions (position telegram, scene value) at the end of automatic operation only if the position data are known and if the positions have been predefined. There is otherwise no reaction at the end of automatic operation.
Position data can be tracked, if the output was in a defined position before the automatic sun protection function or if a new position telegram was received via the position objects during the sun protection. In the latter case, a reference travel will be executed at the end of automatic operation, if the position before or during the sun protection was unknown. Known slat positions will also be tracked as described. This is also the case, when the height of the blind is unknown.
Long-time travel movements (travels without position preset) will always be tracked.

Presetting a time delay for beginning and end of sunshine / shading

The telegram received via the object "Sunshine / shading facade" for activation or deactivation of shading (depending on polarity) can be evaluated with a time delay separately for each output. The preset delay times are always evaluated in the simple as well as in the enlarged sun protection mode.

For the sun protection parameters to be visible, the sun protection function must be enabled on parameter page "Ax – Enabled functions (x = number of output)".

- Set the parameter "Time delay at the beginning of sunshine / shading" on parameter page "Ax – Beginning of sun protection" to the required delay time.
The telegram for activation of the sun protection will be evaluated with a delay corresponding to the setting.
 - Set the parameter "Time delay at the end of sunshine / shading" to the required delay time.
The telegram for deactivation of the sun protection will be evaluated with a delay corresponding to the setting.
- i** A setting of "0" in the parameters deactivates the respective delay time. In this case, the state of the sunshine signal is evaluated immediately.
- i** Simple sun protection mode: An update (from activated to activated) of the "Sunshine / shading facade" object causes the sun protection to be reactivated in consideration of the delay time, if the sun protection had been influenced or aborted beforehand by a direct operation because of the same or a lower priority.

- i** Enlarged sun protection mode: The time delay is started after an update of the "Sunshine / shading facade" object also in those cases where the automatic operation is deactivated so that the newly received information about the sunshine conditions may possibly also be processed with a delay, if the automatic operation is activated later on. Unlike in the simple sun protection mode, an update of the "Sunshine / shading facade" object from active to active or from inactive to inactive in the enlarged sun protection mode shows generally no reaction. The behaviour of the output is only influenced if a change of state is being detected. An update of the sunshine signal alone does not result in the activation of the automatic operation either.

Presetting the reaction at the beginning of sunshine / shading

The behaviour of the output at the beginning of sunshine / shading – if applicable, after the end of the delay time – can be configured in the ETS separately for each output. In the simple sun protection mode, the behaviour will be executed, when the sun protection function is activated after receiving a new sunshine signal. In the enlarged sun protection mode, the output shows the parameterized reaction, when automatic operation is activated and when a new sunshine signal ("sun is shining") is being received or was received beforehand. The reaction will not be executed if a function with a higher priority is active at the time the new sunshine signal is received.

The reaction at the beginning of sunshine / shading is preset on parameter page "Ax – Beginning of sun protection" (x = number of output). Depending on the selected mode of operation, the ETS adapts the designations of the parameter settings ("raising" ↔ "opening the louver" / "lowering" ↔ "closing the louver"). The ETS equally adapts the parameter selection depending on the preset mode of operation.

For the sun protection parameters to be visible, the sun protection function must be enabled on parameter page "Ax – Enabled functions (x = number of output)".

- Set the parameter "Reaction at the beginning of sunshine / shading" to "no reaction".
At the beginning of shading, the output switches over to sun protection while the relays of the output show no reaction. Any travel movements still in progress at this instant will still be finished.
- Set the parameter "Reaction at the beginning of sunshine / shading" to "raising" or "opening the louver".
At the beginning of shading, the actuator raises the curtain or opens the venting louver.
- Set the parameter "Reaction at the beginning of sunshine / shading" to "lowering" or "closing the louver".
At the beginning of shading, the actuator lowers the curtain or closes the venting louver.
- Set the parameter "Reaction at the beginning of sunshine / shading" to "stop".
At the beginning of shading, the actuator switches the relays of the output to the "stop" position. A travel movement, if any, will be interrupted.
- Set the parameter "Reaction at the beginning of sunshine / shading" to "internal scene recall". The number of the scene to be recalled must be specified in the parameter "Scene number (1...8)".
At the beginning of shading, the blind actuator recalls the position value preset in the scene configuration for the output concerned. This is not a scene recall as in direct operation, but only an approach to the corresponding scene position value.
- Set the parameter "Reaction at the beginning of sunshine / shading" to "fixed position".
At the beginning of shading, the blind actuator recalls a fixed position value for the output concerned.

- i** In the "Blinds" mode of operation, the setting "fixed position" can be selected separately for the height of the blind and for the slat position. For this reason, the ETS adapts the parameter selection and enlarges the setting options in this mode of operation.

- "Fixed position" only: Set the parameter "Fixed position of blind", "Fixed position of shutter/awning" or "Fixed position of venting louver" to "as specified by parameter". Thereafter, set the parameter "Position of blind (0...100%)", "Position of shutter/awning (0...100%)" or "Position of venting louver (0...100%)" to the desired position.
At the beginning of shading, the output invariably approaches the parameterized position value.
 - "Fixed position" only: Set the parameter "Fixed position of blind", "Fixed position of shutter/awning" or "Fixed position of venting louver" to "no change of current position".
At the beginning of shading, the last adjusted height of the blind, of the shutter, of the awning or of the venting louver will be maintained.
 - "Fixed position" and mode of operation = "blind" only: Set the parameter "Fixed slat position (0...100%)" to the desired position value.
At the beginning of shading, the output invariably moves the slats to the parameterized position after the height of the blind has been adjusted.
 - Set the parameter "Reaction at the beginning of sunshine / shading" to "variable position".
At the beginning of shading, the blind actuator recalls the variable position value for the output concerned. The variable preset of the blind height, or the shutter, awning or venting louver positions takes place via the separate communication object "Sunsh./shading ... position" (for the slats in the "Blind" mode also via the separate object "Sunsh./shading slat position").
- i** In the "Blind" mode of operation, the "variable position" setting can be selected separately for the height of the blind and for the slat position. For this reason, the ETS adapts the parameter selection and enlarges the setting options in this mode of operation.
- i** The behaviour preset in this parameter will only be executed, if no function with a higher priority (e.g. safety) is activated at the time of shading.
- i** "Internal scene recall" setting: For this setting, the scene function of the output must be enabled in the ETS. Otherwise, the positions approached at the beginning of sunshine/shading are undefined positions. The scene position values stored in the actuator by a scene storage function will be approached as well. A delay configured for scene recalls has no influence on the recall of the scene value by the sun protection function.
- i** "Variable position" setting: After an ETS programming operation or after switch-on of the supply voltage, the objects "Sunsh./shading ... position" and "Sunsh./shading slat position" must receive position values from the bus. Otherwise, the actuator makes no positioning attempts at the beginning of sunshine/shading as it has no valid position data.
When the actuator is in operation, the position data can be updated at any time via the bus even if the sun protection is active (e.g. by a weather station for the purpose of sun position tracking). The blind actuator will then immediately approach the newly received positions if the sun protection is active. If a function with a higher priority is active, the actuator stores the newly received position values and approaches them during a later shading operation. The position data last received are not lost in a bus voltage failure (mains voltage on).

Presetting a forced reference travel in the sun protection mode

If needed, a reference travel can be executed by forced-control in the simple and in the enlarged sun protection mode at the beginning of a shading cycle, if fixed or variable position values or scene positions are to be approached. The execution of a reference travel by forced control at the beginning of shading can be used in a sun protection positioning operation to ensure that the curtains or slats are moved synchronously by different outputs to identical positions (e.g. in a long row of windows). Without the execution of reference travel by forced control, there might otherwise be positioning inaccuracies with a negative effect on the overall appearance of a building facade with the blinds let down.

A reference travel by forced control will always be executed in the simple sun protection mode, when the beginning of shading is signalled for the first time via the

"Sunshine/shading facade" object. Updates of the object from 'sun is shining' to 'sun is shining' do not initiate a reference travel, if the output is still in the sun protection position at this time. A reference travel by forced control will be executed in the enlarged sun protection mode, when the automatic mode is active or is being activated and when the beginning of shading has been signalled via the "Sunshine / shading facade" object. Updates of the object from 'sun is shining' to 'sun is shining' will never initiate a reference travel. In this case, the sunshine signal must first change from 'sun is not shining' to 'sun is shining' before a new reference travel can take place. A reference travel by forced control will always be executed for synchronization purposes as described and also in such cases where the position data of the curtain or the slats are known. No reference travel by forced control will be executed at the end of shading.

For the sun protection parameters to be visible, the sun protection function must be enabled on parameter page "Ax – Enabled functions (x = number of output).

- Set the parameter "Reference travel before every sun protection positioning operation ?" on parameter page "Ax Beginning of sun protection" (x = number of output) to "yes".

At the beginning of shading there is always a reference travel by forced control as described. The preset position will be approached after the end of the reference travel.

- Set the parameter "Reference travel before every sun protection positioning operation ?" on parameter page "Ax Beginning of sun protection" (x = number of output) to "no".

A reference travel at the beginning of sun protection will only be executed, if the position data are unknown, for instance, after an ETS programming operation or after switch-on of the power supply. In all other cases, the preset shading position will be approached immediately.

- i** A reference travel is the time required for a travel movement into the upper end position increased by 20 % and additionally by the parameterized travel time extension. A reference travel is not retriggerable.
- i** Variable position preset: No reference travel will be executed, if new position values are preset via the bus while the sun protection is active.
- i** "Blind" mode of operation: A terminated reference travel of for the height of the blind synchronizes at the same time also the slat position.

Slat offset in the sun protection mode (only "Blind" mode of operation)

For the slat position at the beginning of shading, an offset can be specified separately for each output, if fixed or variable slat positions are to be approached.

If necessary, the slat offset can correct the fixed or variable nominal slat position and thus allow the creation of an individual shading situation, when the sun protection is active. The offset can be preset in two ways...

- The slat offset can be parameterized statically in the ETS. The parameterization of a static offset value allows to vary the degree of shading in those parts of the building that are not exposed to full sunshine due to objects in front of the building. The variable slat angle adjusted by the sun protection control or the fixed angle specified in a parameter can thus be overridden so that the slats are always opened a bit wider than originally preset. Alternatively, the slats can also be closed completely by means of the static offset if too much sunlight is reflected into the room.
- The slat offset can additionally be adapted by the bus via the separate communication object "Sunshine slat position offset". In this way, the desired slat offset can also be adjusted during an active shading cycle and independent of a direct operation as, for instance, the short-time mode. Thus, it is possible, for instance, that persons in a room can correct the slat angle at any time 'manually' and individually by selecting another preset value at a touch sensor or a visualization. An offset preset via the object overwrites the value parameterized in the ETS.

The preset offset is taken into account in the simple and in the enlarged sun protection mode for each positioning move during an active shading cycle (beginning of sunshine/shading) and added to the predefined nominal slat position. The offset value can be varied within a range from -100 % ... 0 ... 100 % so that the slats can be moved in both directions into the respective

end positions (Figure 25). At an offset of "0 %", the actual slat position is always identical with the predefined nominal slat position for sun protection purposes.

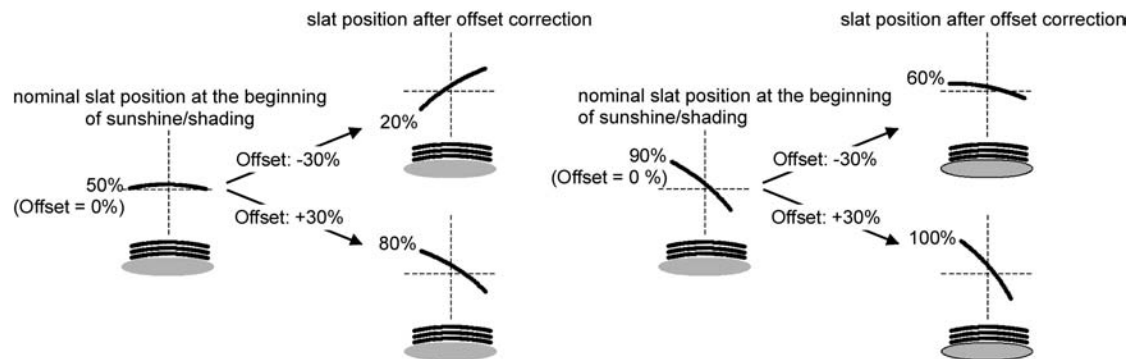

Figure 25: Functional principle of slat offset (example showing slat type 1 / slat type 2 identical)

The position value actually adjusted with the offset after adding the slat position value is always between 0 and 100 %. Minimum and maximum position are thus determined by the slat end positions. These limits cannot be exceeded by specifying an greater offset. Example (Figure 25)

...
 Slat position at the beginning of sunshine/shading = 90 %
 Slat position offset at the beginning of sunshine/shading = +30 %
 -> The resulting slat position is 100% as the end position is reached.

In acc. with the KNX datapoint type 6,001 (DPT_Percent_V8), the data format of the communication object "Sunshine slat position offset" permits presetting positive and negative values in a range of 128 ... 0 ... +127. The actuator interprets the value received directly as an offset in %. Values below 100 or above +100 are limited to the minimum (-100 %) and maximum offset (+100 %) and evaluated accordingly.

An offset preset via the object overwrites the value parameterized in the ETS. In the event of a bus voltage failure or a mains voltage failure of the actuator, an offset value received via the communication object can be stored internally in a non-volatile memory so that the offset value last received is not lost even in case the complete power supply fails (bus voltage and mains voltage failure). As an alternative, the offset preset via the bus can be reset (0 %) in the event of a power supply failure with the result that the value parameterized in the ETS is again used in operation. The offset reaction preset in the event of bus or mains voltage failure can be parameterized in the ETS.

Configuring the slat offset in the sun protection mode (only "Blind" mode of operation)

For the sun protection parameters to be visible, the sun protection function must be enabled on parameter page "Ax – Enabled functions (x = number of output).

The function must be configured for the "Blind" mode of operation.

The reaction at the beginning of sunshine/shading must be configured for fixed or variable position preset.

- Set the parameter "Offset with fixed and variable slat position" on parameter page "Ax Beginning of sun protection" (x = number of output) to "no offset".

The offset correction is deactivated. During shading (beginning of sunshine/shading), the fixed or variable slat position will be approached without offset correction. The other parameter relating to the offset are blanked out.
- Set the parameter "Offset with fixed and variable slat position" to "offset as parameterized".

The static offset correction based on the parameter preset in the ETS is activated. During every shading operation (beginning of sunshine/shading), the nominal slat position is always corrected by the parameterized offset value.

- Set the parameter "Offset with fixed and variable slat position" to "offset as parameterized and via object".

The offset correction based on the parameter preset in the ETS and via the object is activated. The slat offset is preset by a fixed value parameterized in the ETS and can be adapted dynamically with a separate communication object. During every shading operation (beginning of sunshine/shading), the nominal slat position is always corrected by the preset offset value.
 - Set the parameter "Slat offset position (-100 ... 100 %)" on parameter page "Ax - Beginning of sun protection" to the desired offset value.

The parameterized value defines the static offset correction of the slat position. The parameterized value can be re-adjusted via the "Sunshine slat position offset" object, if the communication object has been enabled.
 - Set the parameter "Store slat position offset adjusted via object in case of bus / mains voltage failure ?" to "no".

The value received via the object will only be stored temporarily in volatile memory. Thus, the value received via the object only replaces the parameterized value only until the actuator is re-initialized (return of bus or mains voltage, if both voltages were off beforehand). After the initialization, the offset value parameterized in the ETS will be used again.
 - Set the parameter "Store slat position offset adjusted via object in case of bus / mains voltage failure ?" to "yes".

The value received via the object will be stored in case of bus or mains voltage failure in a non-volatile memory of the actuator. The originally parameterized offset value is definitely overwritten in the process. Only a new ETS programming operation sets the offset back to the parameterized value.
-
- i** An offset value received via the bus is stored temporarily or permanently in the actuator and taken into account during the next shading operation. The reception of an offset value during an active shading phase (beginning of sunshine/shading active) results in an immediate and 'visible' correction of the offset angle by the output.
 - i** After an ETS programming operation, the offset is always set to the value parameterized in the ETS.
 - i** Storage of the slat offset position in case of bus/mains voltage failure: The offset value preset via the object is stored only if one part of the supply voltage (mains or bus) is still present or if the supply fails completely after the mains voltage has been available before without interruption for at least 20 seconds after the last reset (storage capacitors sufficiently charged for storage purposes). In all other cases nothing is stored.
 - i** The slat offset has no influence on the behaviour of an output at the end of a shading phase (end of sunshine/shading).

Presetting the reaction at the end of sunshine / shading (for simple sun protection only)

At the end of the shading phase – if applicable, after the end of the delay time – the output concerned will show the preset reaction, if no function with a higher priority is active at the time of deactivation. The preset reaction will not be executed at the end of shading either, if the sunshine signal is overridden on account of priority settings by a direct operation.

The reaction at the end of shading is preset on parameter page "Ax – Sun protection" (x = number of output). Depending on the selected mode of operation, the ETS adapts the designations of the parameter settings ("raising" ↔ "opening the louver" / "lowering" ↔ "closing the louver").

For the sun protection parameters to be visible, the sun protection function must be enabled on parameter page "Ax – Enabled functions (x = number of output).

The function must have been configured for simple sun protection.

- Set the parameter "Reaction at the end of sunshine / shading" to "no reaction".

At the end of shading, the relay of the output shows no reaction. Any travel movements still in progress at this instant will still be finished.

- Set the parameter "Reaction at the end of sunshine / shading" to "raising" or "opening the louver".

At the end of shading, the actuator raises the curtain or opens the venting louver.

- Set the parameter "Reaction at the end of sunshine / shading" to "lowering" or "closing the louver".

At the end of shading, the actuator lowers the curtain or closes the venting louver.

- Set the parameter "Reaction at the end of sunshine / shading" to "stop".

At the end of shading, the actuator switches the relays of the output to the "stop" position. A travel movement, if any, will be interrupted.

- Set the parameter "Reaction at the end of sunshine / shading" to "position tracking".

At the end of shading, the output will be set to the state last adjusted statically before sun protection or to the state tracked and internally stored during sun protection. The position objects, the long-time object and the scene function are tracked.

i The behaviour preset in this parameter will only be executed, if no function with a higher priority (e.g. safety) is activated when the sun protection is enabled or when a direct operation has not overridden the sunshine signal on account of priority settings.

i Parameter setting "Position tracking": The blind actuator can track absolute positions (position telegram, scene value) at the end of sun protection only if the position data are known and if the positions have been predefined. There is otherwise no reaction at the end of shading.

Position data can be tracked, if the output was in a defined position before the sun protection function or if a new position telegram was received via the position objects during the sun protection. In the latter case, a reference travel will be executed at the end of the sun protection, if the position before or during the sun protection was unknown. Known slat positions will also be tracked as described. This is also the case, when the height of the blind is unknown.

Long-time travel movements (travels without position preset) will always be tracked.

Presetting the reaction at the end of sunshine / shading (for enlarged sun protection only)

The behaviour of the output at the end of sunshine / shading – if applicable, after the end of the delay time – can be configured in the ETS separately for each output. In the enlarged sun protection mode, the output shows the parameterized reaction, when automatic operation is activated and when a new sunshine signal

(change of state from "sun is shining" -> "sun is not shining") is being received. The reaction will not be executed if a function with a higher priority is active at the time the sunshine signal changes. The preset reaction will not be executed either, if the sunshine signal is overridden on account of priority settings by a direct operation.

The reaction at the end of sunshine / shading is preset on parameter page "Ax – Beginning of sun protection" (x = number of output). Depending on the selected mode of operation, the ETS adapts the designations of the parameter settings ("raising" ↔ "opening the louver" / "lowering" ↔ "closing the louver").

For the sun protection parameters to be visible, the sun protection function must be enabled on parameter page "Ax – Enabled functions (x = number of output).

The function must have been configured for enlarged sun protection.

- Set the parameter "Reaction at the end of sunshine / shading" to "no reaction".

At the end of shading, the relay of the output shows no reaction. Any travel movements still in progress at this instant will still be finished.

- Set the parameter "Reaction at the end of sunshine / shading" to "raising" or "opening the louver".

At the end of shading, the actuator raises the curtain or opens the venting louver.

- Set the parameter "Reaction at the end of sunshine / shading" to "lowering" or "closing the louver".
At the end of shading, the actuator lowers the curtain or closes the venting louver.
 - Set the parameter "Reaction at the end of sunshine / shading" to "stop".
At the end of shading, the actuator switches the relays of the output to the "stop" position. A travel movement, if any, will be interrupted.
 - Set the parameter "Reaction at the end of sunshine / shading" to "internal scene recall".
The number of the scene to be recalled must be specified in the parameter "Scene number (1...8)".
At the end of shading, the blind actuator recalls the position value preset in the scene configuration for the output concerned. This is not a scene recall as in direct operation, but only an approach to the corresponding scene position value.
 - Set the parameter "Reaction at the end of sunshine / shading" to "fixed position".
At the end of shading, the blind actuator recalls a fixed position value for the output concerned.
- i** In the "Blind" mode of operation, the setting "fixed position" can only be selected in common for the height of the blind and for the slat position.
- "Fixed position" only: Set the parameter "Fixed position of blind", "Fixed position of shutter/awning" or "Fixed position of venting louver" to "as specified by parameter". Thereafter, set the parameter "Position of blind (0...100%)", "Position of shutter/awning (0...100%)" or "Position of venting louver (0...100%)" to the desired position.
At the end of shading, the output invariably approaches the parameterized position value.
 - "Fixed position" only: Set the parameter "Fixed position of blind", "Fixed position of shutter/awning" or "Fixed position of venting louver" to "no change of current position".
At the end of shading, the last adjusted height of the blind, of the shutter, of the awning or of the venting louver will be maintained.
 - "Fixed position" and mode of operation = "blind" only: Set the parameter "Fixed slat position (0...100%)" to the desired position value."
At the end of shading, the output invariably moves the slats to the parameterized position after the height of the blind has been adjusted.
- i** The behaviour preset in this parameter will only be executed, if no function with a higher priority (e.g. safety) is activated at the time the sunshine signal changes. The preset reaction will not be executed either, if the sunshine signal is overridden on account of priority settings by a direct operation.
- i** "Internal scene recall" setting: For this setting, the scene function of the output must be enabled in the ETS. Otherwise, the positions approached at the end of sunshine/shading are undefined positions. The scene position values stored in the actuator by a scene storage function will be approached as well. A delay configured for scene recalls has no influence on the recall of the scene value by the sun protection function.

Sun protection application examples

The present chapter describes different applications of the sun protection function of the blind actuator in combination with the Gira KNX / EIB weather station (order no. 1010 00) and the combination sensor (order no. 1025 00).

The applications described can be used in the simple and in the enlarged sun protection mode. For the enlarged sun protection it is important that the automatic function must be activated, if the sunshine signal of the weather station is to be evaluated and a reaction produced at the output. The disabling functions can optionally also be used for automatic operation or for direct operation.

For each application, there is also an outline given of which communication objects of the weather station are to be linked to the blind actuator.

Information on the required configuration of the KNX / EIB weather station can be found in the corresponding product documentation.

- I. Sun protection with brightness limit value monitoring and fixed sun protection positions:
The limit value monitoring function of the weather station is used. The weather station transmits a "1" telegram via the "Limit value 1 [Sun...]" to the bus when a preset brightness limit value is exceeded. The shutter actuator activates the shading function and adjusts the curtain to the corresponding fixed sun protection position. In the operating mode "Blind" of the shutter actuator, the fixed slat position specified in the parameter is recalled in addition. When the brightness drops below the limit value for the measured brightness (with hysteresis, if programmed), the weather station transmits a "0" telegram to the bus. This deactivates the shading function in the shutter actuator and the corresponding reaction at the end of sunshine /shading will be executed. The communication objects must be linked according to presetting.

Required parameterization of the shutter actuator (parameters not listed are optional):

- simple or enlarged sun protection,
- polarity object "Sunshine / shading facade" = "1" sunshine,
- reaction at the beginning of sunshine / shading = fixed position,
- fixed positions setting.(Figure 26)



Figure 26: Programming of the communication objects for application example I

- II. Sun protection with shading control and fixed sun protection positions:

The shading control of the weather station is used. When the preset basic brightness for shading operations is exceeded, the weather station transmits a 1-bit telegram of value "1" via the "Shading facade [shading control facades 1-4]" to the bus. The shutter actuator activates the shading function and adjusts the curtain to the corresponding fixed sun protection position. In the operating mode "Blind" of the shutter actuator, the fixed slat position specified in the parameter is recalled in addition. When the brightness drops below the basic brightness for shading operations (with hysteresis, if programmed), the weather station transmits a "0" telegram to the bus. This deactivates the shading function in the shutter actuator and the corresponding reaction at the end of sunshine /shading will be executed. The communication objects must be linked according to presetting.

Required parameterization of the shutter actuator (parameters not listed are optional):

- simple or enlarged sun protection,
- polarity object "Sunshine / shading facade" = "1" sunshine,
- reaction at the beginning of sunshine / shading = fixed position,
- fixed positions setting.(Figure 27)



Figure 27: Programming of the communication objects for application example II

- III. Sun protection with shading control and fixed curtain height and variable slat position tracking:

The shading control of the weather station is used. The blinds connected to the shutter actuator are slatted blinds. When the basic brightness for shading operations is exceeded, the weather station transmits a 1-bit telegram of value "1" via the "Shading facade [shading control facade 1-4]" to the bus. The shutter actuator activates the shading function and adjusts the shutter to the corresponding fixed sun protection position. The individual facade control of the weather station transmits additionally the slat position to be preset for sun-dependent slat tracking via the 1-byte object "Slat position (%) facade [individual control facade ...]" to the bus. The slat position required for shading will thus be adjusted in the shutter actuator. When the brightness drops below the basic brightness for shading operations (with hysteresis, if programmed), the weather station transmits a "0" telegram via the "Shading facade [shading control facade 1-4]" to the bus. This deactivates the shading function in the shutter actuator and the corresponding reaction at the end of sunshine / shading will be executed.

Ideally, the telegram "Slat position (%) facade [individual facade control ...]" = "0 %" is suppressed in the weather station by means of a parameter. The extra slat positioning movement might otherwise adversely affect the behaviour of the output at the end of shading (possibly brief bucking).

The global disabling function of the weather station should not be used for disabling the individual facade control. Disabling can be achieved, for instance, with the disabling function of the automatic operation in the shutter actuator and individually for each output. The communication objects must be linked according to presetting.

Required parameterization of the shutter actuator (parameters not listed are optional):

- simple or enlarged sun protection,
- polarity object "Sunshine / shading facade" = "1" sunshine, reaction at the beginning of sunshine / shading = fixed blind position, variable slat position,
- fixed blind position setting.(Figure 28)

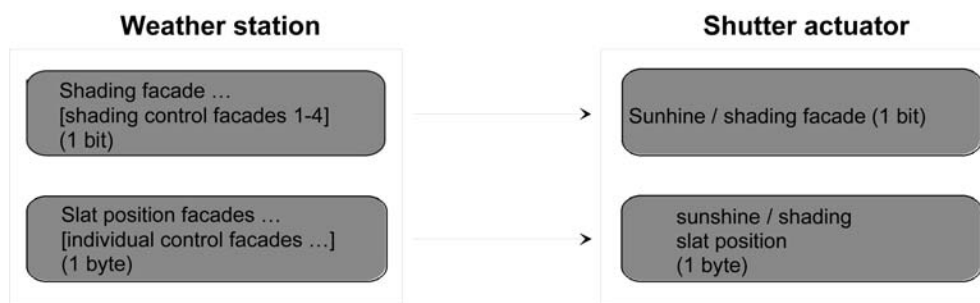

Figure 28: Programming of the communication objects for application example III

- IV. Sun protection with shading control and variable curtain height and variable slat position tracking:

The shading control of the weather station is used. The blinds connected to the shutter actuator are slatted blinds. When the basic brightness for shading operations is exceeded, the weather station transmits a 1-bit telegram of value "1" via the "Shading facade [shading control facade 1-4]" to the bus. The shutter actuator activates the shading function.

The individual facade control of the weather station transmits additionally the slat position to be preset for sun-dependent slat tracking via the 1-byte object "Slat position (%) facade [individual control facade ...]" and the blind height to be adjusted via the 1-byte object "shading facade curtain height threshold/position [individual control facade ...]" to the bus. The slat position and the blind height required for shading will thus be adjusted in the shutter actuator.

When the brightness drops below the basic brightness for shading operations (with hysteresis, if programmed), the weather station transmits a "0" telegram via the "Shading facade [shading control facade 1-4]" to the bus. This deactivates the shading function in the shutter actuator and the corresponding reaction at the end of sunshine / shading will be executed.

Ideally, the telegrams "Slat position (%) facade [individual facade control ...]" = "0 %" and "Shading facade curtain height threshold/position [individual control facade ...]" = 0 % are suppressed in the weather station by means of a parameter. The extra slat and blind positioning movement might otherwise adversely affect the behaviour of the output at the end of shading (possibly brief bucking).

The global disabling function of the weather station should not be used for disabling the individual facade control. Disabling can be achieved, for instance, with the disabling function of the automatic operation in the shutter actuator and individually for each output. The communication objects must be linked according to presetting.

Required parameterization of the shutter actuator (parameters not listed are optional):

- simple or enlarged sun protection,
- polarity object "Sunshine / shading facade" = "1" sunshine,
- reaction at the beginning of sunshine / shading = variable blind position, variable slat position.(Figure 29)

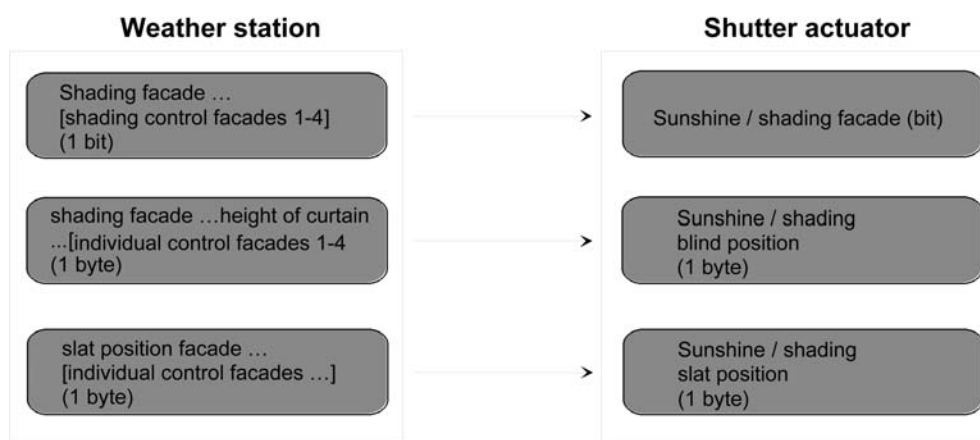

Figure 29: Programming of the communication objects for application example IV

- V. Sun protection with shading control and variable curtain height and fixed slat position:

The shading control of the weather station is used. The blinds connected to the shutter actuator are slatted blinds. When the basic brightness for shading operations is exceeded, the weather station transmits a 1-bit telegram of value "1" via the "Shading facade [shading control facade 1-4]" to the bus. The shutter actuator activates the shading function and adjusts the corresponding fixed sun protection position for the slat angle.

The individual facade control of the weather station transmits additionally the blind height to be adjusted via the 1-byte object "Shading facade curtain height threshold/position [individual control facade ...]" to the bus. The blind height required for shading will thus be adjusted in the shutter actuator.

When the brightness drops below the basic brightness for shading operations (with hysteresis, if programmed), the weather station transmits a "0" telegram via the "Shading facade [shading control facade 1-4]" to the bus. This deactivates the shading function in the shutter actuator and the corresponding reaction at the end of sunshine / shading will be executed.

Ideally, the telegram "Shading facade curtain height threshold/position [individual facade control ...]" = "0 %" is suppressed in the weather station by means of a parameter. The extra blind positioning movement might otherwise adversely affect the behaviour of the output at the end of shading (possibly brief bucking).

The global disabling function of the weather station should not be used for disabling the individual facade control. Disabling can be achieved, for instance, with the disabling function of the automatic operation in the shutter actuator and individually for each output. The communication objects must be linked according to presetting.

Required parameterization of the shutter actuator (parameters not listed are optional):

- simple or enlarged sun protection,
- polarity object "Sunshine / shading facade" = "1" sunshine,
- reaction at the beginning of sunshine / shading = variable blind position, fixed slat position,
- fixed slat position setting.(Figure 30)



Figure 30: Programming of the communication objects for application example V

Automatic heating/cooling

Automatic heating/cooling can supplement the extended sun protection so that the sun shading of a room is available to an additional application.

When automatic heating / cooling is active, a presence signal – e.g. from a KNX / EIB presence monitor or a detector – is evaluated in addition to the signals of the extended sun protection function. The automatic sun protection function will then only be activated by the shutter actuator when persons are in the room. The room is then shaded or not shaded according to the sunshine signal - as described in previous chapters.

If no presence is signalled to the Venetian blind actuator, then the actuator also evaluates a

heating/cooling signal, which can be derived from a room temperature controller or an external thermostat, for example. In this case, the shading function can be used to support the heating or cooling function in a room. As no people are present in the room, intensive sunlight can be used, for instance, to heat up the room by opening the slats or by raising the blind. Similarly, the room can also be shaded against sunlight during the absence of people, if additional heating up of the room is not desired.

The evaluation of the three 1 bit signals "Presence", "Heating/cooling switchover" and "Sunshine / shading facade", whose telegram polarity can be set independently in the ETS, means that the extended sun protection function with automatic heating/cooling differentiates between the 6 statuses shown in Table 2 and the corresponding output reactions.

Presence signal	Heating/cooling switchover	Sunshine / shading facade	Reaction at output
People present	--- (irrelevant)	Sunshine signal active	Reaction at the beginning of sunshine/shading
People present	--- (irrelevant)	Sunshine signal inactive	Reaction at the end of sunshine/shading
No people present	Heating active	Sunshine signal active	Reaction at the beginning of sunshine/shading with heating
No people present	Heating active	Sunshine signal inactive	Reaction at the end of sunshine/shading with heating
No people present	Cooling active	Sunshine signal active	Sunshine signal active reaction at the beginning of sunshine/shading with cooling
No people present	Cooling active	Sunshine signal inactive	Reaction at the end of sunshine/shading with cooling

States of the enlarged sun protection function with heating/cooling switchover

As described for the extended sun protection without automatic heating/cooling, the sunshine signal will be delayed, if a delay is configured in the ETS for this signal. In the same way, the presence signal can be evaluated independently after a delay, for example in order to 'debounce' short time changes to the signal state.

The schematic diagram (Figure 31) shows the interaction of the different communication objects of the extended sun protection function in combination with the automatic heating/cooling function. The diagram moreover illustrates the principle of incorporating sensor components into the automatic heating/cooling system.

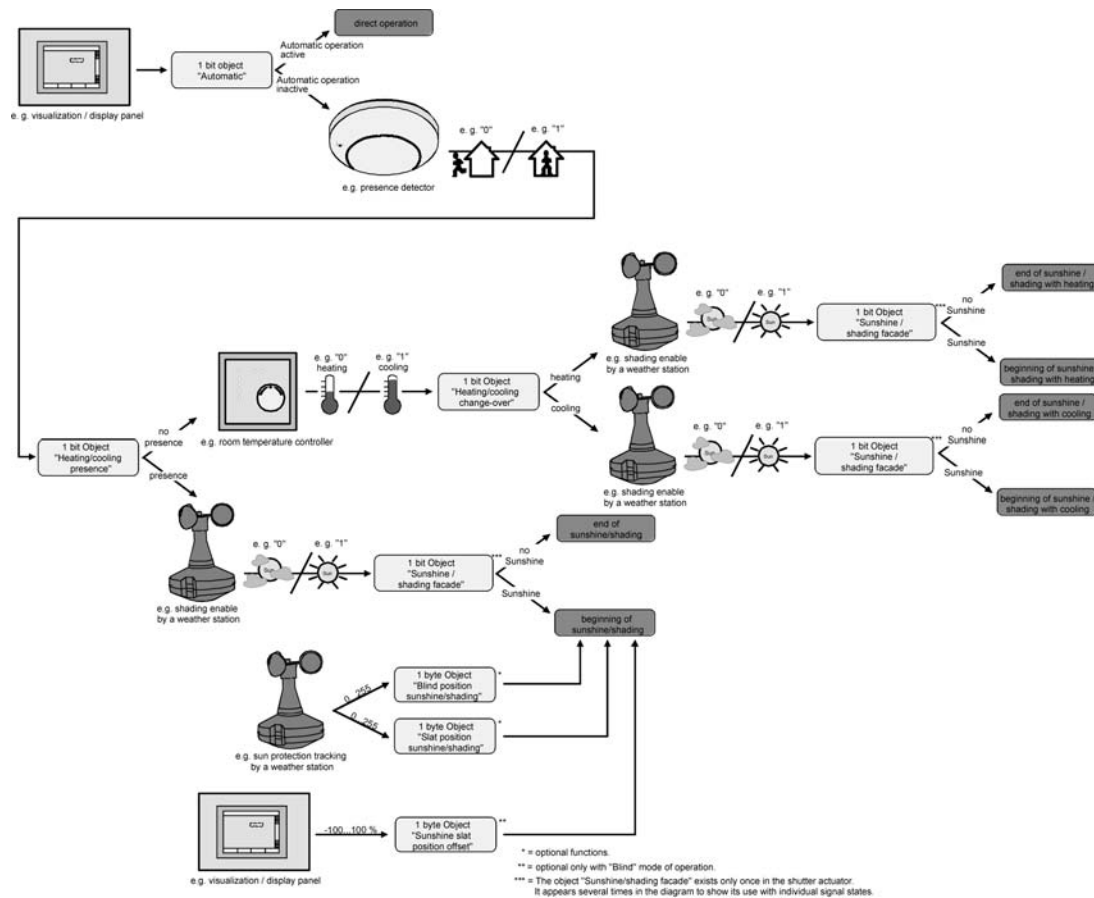

Figure 31: Schematic diagram of automatic heating/cooling (for reasons of simplicity shown without disabling functions of the automatic or direct operation)

In accordance with the schematic diagram, the automatic heating/cooling function is only active when the automatic sun protection is active, too. Like in the extended sun protection mode without automatic heating/cooling, the automatic sun protection is activated via the object "Automatic" depending on the configuration either immediately or only after a change of state has been detected for one of the signals "Presence", "Heating/cooling switchover" and "Sunshine / shading facade" (cf. "Sun protection function – extended sun protection"). After an ETS programming operation or after switch-on of the power supply of the actuator (bus and mains voltage supply), the corresponding communication objects of the signals "Presence", "Heating/cooling switchover" and "Sunshine / shading facade" are initialised with "0". In accordance with the preset polarity, the state of the sunshine and of the presence signal as well as the heating/cooling state will be determined and the corresponding reaction executed provided the automatic sun protection function is active. When the automatic sun protection is active, any change of state of the presence signal or any change in the heating/cooling signal will be evaluated immediately and the corresponding reaction executed.

The schematic function diagram (Figure 32) shows all possible functions of the extended sun protection with automatic heating/cooling. For reasons of clarity, the functions with a higher priority (manual control, forced position, safety function) are not shown in the diagram.

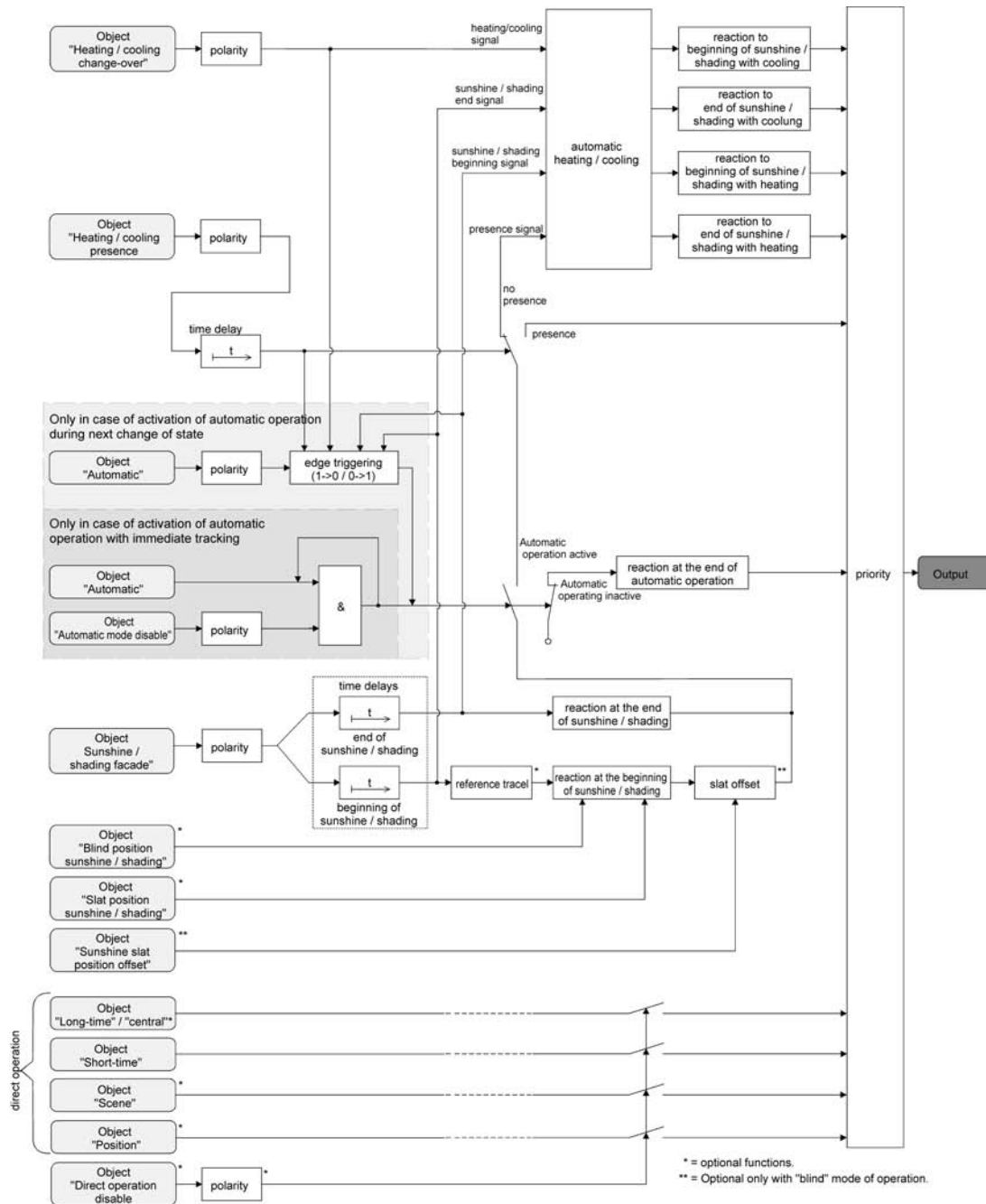

Figure 32: Schematic function diagram of automatic heating/cooling

Enabling automatic heating/cooling

Automatic heating/cooling can be preset separately for each output. When automatic heating/cooling is enabled, the enlarged sun protection function will be supplemented by the necessary communication objects and parameters.

The sun protection function must be enabled on parameter page

"Ax – Enabled functions (x = number of output). Moreover, the function must have been configured for enlarged sun protection.

- Set the parameter "Automatic heating/cooling" on parameter page "Ax – Automatic heating/cooling" to "enabled".

The automatic heating/cooling function is enabled. The necessary parameters and communication objects are visible.

- Set the parameter "Automatic heating/cooling" on parameter page "Ax – Automatic heating/cooling" to "disabled".
The automatic heating/cooling function is deactivated. The corresponding parameters and objects are blanked out. Only the enlarged sun protection without evaluation of the heating/cooling and of the presence signal is now configured.
- ❗ If the automatic heating/cooling activation parameters are changed, the group address assignments and the parameter settings are lost. For this reason, the automatic heating/cooling parameters should be selected directly at the beginning of parameterization and then not be changed anymore later on.

Presetting the polarity of the "Heating/cooling changeover" object

The telegram polarity of the "Heating / cooling changeover" object can be preset separately for each output. This means that an adaptation to the signals from existing room temperature controllers or from outside thermostats is possible.

For the parameters to be visible, automatic heating/cooling must be enabled on parameter page "Ax – Automatic heating/cooling" (x = number of output).

- Set the parameter "Polarity of 'Heating/cooling change-over' object" on parameter page "Ax Sun protection" to the required telegram polarity.
The heating/cooling signal is evaluated in accordance with the preset priority.

- ❗ An update of the "Heating / cooling changeover" object from active to active or from inactive to inactive shows generally no reaction. The behaviour of the output is only influenced if a change of state is being detected.
- ❗ After switch-on of the power supply (bus and mains voltage) of the actuator, the heating/cooling changeover function is initialized with an object value of "0"

Presetting the polarity of the "Heating/cooling presence" object

The telegram polarity of the "Heating / cooling presence" object can be preset separately for each output. This means that an adaptation to the signals from existing KNX/EIB presence monitors or detectors is possible.

For the parameters to be visible, automatic heating/cooling must be enabled on parameter page "Ax – Automatic heating/cooling" (x = number of output).

- Set the parameter "Polarity of 'Heating / cooling presence' object" to the required telegram polarity.
The presence signal is evaluated in accordance with the preset priority.

- ❗ An update of the "Heating / cooling presence" object from active to active or from inactive to inactive shows generally no reaction. The behaviour of the output is only influenced if a change of state is being detected.
- ❗ After switch-on of the power supply (bus and mains voltage) of the actuator, the heating / cooling / presence control is initialized with an object value of "0".

Presetting a time delay for beginning and end of presence

The telegram received via the object "Heating / cooling presence" for transmission of the presence state (depending on polarity) can be evaluated with a time delay separately for each output.

For the parameters to be visible, automatic heating/cooling must be enabled on parameter page "Ax – Automatic heating/cooling" (x = number of output).

- Set the parameter "Time delay at the beginning of presence" to the required delay time.
The telegram for activation of the presence mode will be evaluated with a delay corresponding to the setting.
- Set the parameter "Time delay at the end of presence" to the required delay time.

The telegram for deactivation of the presence mode will be evaluated with a delay corresponding to the setting.

- i** A setting of "0" in the parameters deactivates the respective delay time. In this case, the presence state is evaluated immediately on reception of a telegram.
- i** An update of the "Heating / cooling presence" object from active to active or from inactive to inactive shows generally no reaction. The behaviour of the output is only influenced if a change of state is being detected. An update of the presence signal alone does not result in the activation of automatic operation either.
- i** The time delay is started after an update of the "Heating / cooling presence" object also in those cases where the automatic operation is deactivated so that the newly received presence state may possibly also be processed with a delay, if the automatic operation is activated later on.

Presetting the reaction of automatic heating/cooling

The behaviour of the output when automatic heating/cooling is active can be configured separately for each output. By evaluating the three 1-bit signals "Presence", "Heating/cooling changeover" and "Sunshine / shading facade" a distinction is made between four states...

- "Reaction at the **beginning** of sunshine/shading with **heating**"
- Reaction at the **end** of sunshine/shading with **heating**"
- Reaction at the **beginning** of sunshine/shading with **cooling**"
- Reaction at the **end** of sunshine/shading with **cooling**"

The reaction of an output can be set separately in ETS for each of the four states listed. There is no difference between the parameter settings for the individual states. For this reason, the following text describes the possible configuration only in the form of an example.

The reaction at the end of automatic heating/cooling operation is preset on parameter page "Ax Automatic heating/cooling" (x = number of output). Depending on the selected mode of operation, the ETS adapts the designations of the parameter settings ("raising" ↔ "opening the louver" / "lowering" ↔ "closing the louver").

For the parameters to be visible, automatic heating/cooling must be enabled on parameter page "Ax – Automatic heating/cooling" (x = number of output).

- Set the parameter "Reaction at the ... of sunshine / shading" to "no reaction".
During automatic heating/cooling, the relays of the output show no reaction. Any travel movements still in progress will still be finished.
- Set the parameter "Reaction at the ... of sunshine / shading" to "raising" or "opening the louver".
During automatic heating/cooling, the actuator raises the curtain or opens the venting louver.
- Set the parameter "Reaction at the ... of sunshine / shading" to "lowering" or "closing the louver".
During automatic heating/cooling, the actuator lowers the curtain or closes the venting louver.
- Set the parameter "Reaction at the ... of sunshine / shading" to "stop".
During automatic heating/cooling, the actuator switches the relays of the output to the "stop" position. A travel movement, if any, will be interrupted.
- Set the parameter "Reaction at the ... of sunshine / shading" to "internal scene recall". The number of the scene to be recalled must be specified in the parameter "Scene number (1...8)".
During automatic heating/cooling, the blind actuator recalls the position value preset in the scene configuration for the output concerned. This is not a scene recall as in direct operation, but only an approach to the corresponding scene position value.
- Set the parameter "Reaction at the ... of sunshine / shading" to "fixed position".

During automatic heating/cooling, the blind actuator recalls a fixed position value for the output concerned.

- i** In the "Blind" mode of operation, the setting "fixed position" can only be selected in common for the height of the blind and for the slat position.
- "Fixed position" only: Set the parameter "Fixed position of blind", "Fixed position of shutter/awning" or "Fixed position of venting louver" to "as specified by parameter". Thereafter, set the parameter "Position of blind (0...100%)", "Position of shutter/awning (0...100%)" or "Position of venting louver (0...100%)" to the desired position.
During automatic heating/cooling, the output invariably approaches the parameterized position value.
 - "Fixed position" only: Set the parameter "Fixed position of blind", "Fixed position of shutter/awning" or "Fixed position of venting louver" to "no change of current position".
During automatic heating/cooling, the position the last adjusted of the blind, of the shutter, of the awning or of the venting louver will be maintained.
 - "Fixed position" and mode of operation = "blind" only: Set the parameter "Fixed slat position (0...100%)" to the desired position value".
During automatic heating/cooling, the output invariably moves the slats to the parameterized position after the height of the blind has been adjusted.

i The parameterized reactions will not be executed if a function with a higher priority is active during automatic heating/cooling (e.g. safety function, forced position or manual control). The preset reaction will not be executed either, if the automatic sun protection is overridden on account of priority settings by a direct operation.

i "Internal scene recall" setting: For this setting, the scene function of the output must be enabled in the ETS. Otherwise, the positions approached during automatic heating/cooling are undefined positions. The scene position values stored in the actuator by a scene storage function will be approached as well. A delay configured for scene recalls has no influence on the recall of the scene value by the automatic heating/cooling function.

Scene function (with 4/8-channel device variant only available with ETS3.0d and higher).

An actuator can hold up to 8 scenes for each output and store scene position values for the height of a blind, shutter or awning or the position of a venting louver. In the 'Blind' mode, the user can also preset slat positions. The scene values are recalled or stored via a separate scene extension object by means of extension telegrams. A scene recall can optionally also be delayed.

The datapoint type of the extension object permits addressing of up to 64 scenes max. Therefore the parameter settings of a scene can be used to define the scene number (1...64) which is used to address the internal scene (1...8).

For the necessary communication objects and parameters (on the "Ax Scenes" parameter page) to be displayed, the scene function must be enabled for each output on parameter page "Ax – Enabled functions (x = number of output).

The scene function must be assigned to direct operation via short-time, long-time, central or position telegrams, as for control of the output. For this reason, a recalled scene position can at any time be overridden by a manual control, a forced position or a safety function. The scene position last recalled can also be readjusted by other telegrams of the direct operation mode. The priority of direct operation and also of the scene function can be parameterized with respect to the sun protection function (cf. "Sun protection function").

Presetting a scene recall delay for the scene function

Each scene recall of an output can optionally also be delayed. With this feature, dynamical scene sequences can be configured if several outputs are combined with cyclical scene telegrams.

The scene function must be enabled on parameter page "Ax – Enabled functions (x = number of output).

- Set the parameter "Delay scene recall?" on parameter page "Ax – Scenes" to "yes".
The delay time is now activated and can be parameterized separately. The delay only influences the scene recall of the output. The delay time is started on arrival of a recall telegram. The corresponding scene will be recalled and the output set to the respective scene position value only after this time has elapsed.

- i** Each scene recall telegram restarts the delay time and retriggers it. If a new scene recall telegram is received while a delay is active (scene recall not yet executed), the old (and not yet recalled scene) will be rejected and only the scene last received executed.
- i** The scene recall delay has no influence on the storage of scene values. A scene storage telegram within a scene recall delay terminates the delay and thus the scene recall.
- i** In case of bus voltage failure, all time functions will be stopped. Therefore, all scene recalls that are still in the delay stage will be aborted. A scene recall received shortly before bus voltage failure is then lost, if the corresponding delay has not yet elapsed. A delayed scene recall will also be aborted, if a function with a higher priority (manual control, forced position, safety, sun protection, if the priority is the same as or higher than that of direct operation) is activated. The scene recall is nevertheless stored internally so that the scene positions last recalled can be tracked at the end of a higher-ranking function.

Presetting the ETS download behaviour for the scene function

During storage of a scene, the scene values are stored permanently in the device (cf. "Presetting the storage behaviour for scene functions"). To prevent the stored values from being replaced during ETS programming of the application or of the parameters by the originally programmed scene position values, the actuator can inhibit overwriting of the scene values. As an alternative, the original values can be reloaded into the device during each programming run of the ETS.

The scene function must be enabled on parameter page "Ax – Enabled functions (x = number of output).

- Set the parameter "Overwrite the values stored in the device during an ETS download ?" on parameter page "Ax – Scenes" to "Yes".
During each ETS programming of the application or of the parameters, the scene values parameterized in the ETS for the output concerned will be programmed into the actuator. Scene values stored in the device by means of a storage function will be overwritten, if any.
 - Set the parameter "Overwrite the stored values in the device during an ETS download ?" on parameter page "Ax – Scenes" to "No".
Scene values stored in the device with a storage function will be maintained. If no scene values have been stored, the position values last programmed in the ETS remain valid.
- i** When the actuator is put into operation for the first time, this parameter should be set to "yes" so that the output is initialized with valid scene values. In the blind actuator as delivered, the scene positions are internally set to default values as in the ETS product database.

Presetting scene numbers

The datapoint type of the scene extension object permits addressing of up to 64 scenes max. For this reason, the scene number (1...8) with which the scene is addressed, i.e. recalled or stored, must be determined for each internal scene (1...64) of the output.

The scene function must be enabled on parameter page "Ax – Enabled functions (x = number of output).

- Set the parameter "Scene y activatable by scene number" (y = number of the scene (1...8)) on parameter page "Ax – Scenes" for each scene to the numbers with which the scenes are to be addressed.

A scene can be addressed with the parameterized scene number. A setting of "0" deactivates the corresponding scene so that neither recalling nor storage is possible.

- i** If the same scene number is parameterized for several scenes, only the scene with the lowest internal scene number (1...8) will be addressed. The other internal scenes will be ignored in this case.

Presetting scene positions

Moreover, the position value (blind, shutter, awning, venting louver position) to be set for the output in case of a scene recall must be specified as well. In the "Blind" mode, the height of the blind and the slat position can be preset.

The scene function must be enabled on parameter page "Ax – Enabled functions (x = number of output).

- Set the parameter "Position ... for scene y" (y = number of the scene (1...8)) on parameter page "Ax – Scenes" for each scene to the desired position (0 %...100 %).
In case of a scene recall, the output is set to the parameterized position.

- i** The parameterized position values are adopted in the actuator during programming with the ETS only if the parameter "Overwrite values stored in the device during an ETS download ?" is set to "yes".

- i** Before approaching the required scene position, the blind actuator performs a reference travel, if the current position data are unknown (e.g. after an ETS programming operation or after switch-on of the supply voltage).

Presetting the storage behaviour for the scene function

The current position value of a blind, shutter, awning, venting louver and also of a slat can be stored internally via the extension object on reception of a scene storage telegram. The position value can be influenced before storage by all functions of the output (e.g. short-time and long-time operation, central or scene recall telegram, safety and sun protection function and manual control).

The scene function must be enabled on parameter page "Ax – Enabled functions (x = number of output).

- Set the parameter "Storage function for scene y" (y = number of the scene (1...8)) on parameter page "Ax – Scenes" for each scene to "yes".

The storage function is activated for the scene in question. On reception of a storage telegram via the "Scene extension" object, the current position value will be internally stored.

- Set the parameter "Storage function for scene y" (y = number of the scene (1...8)) on parameter page "Ax – Scenes" for each scene to "no".

The storage function is deactivated for the scene in question. A storage telegram received via the "scene extension" object will be rejected.

- i** The following rules apply for the position data to be stored:
 The current curtain, slat and louver positions are stored. With blinds, the height to be stored is always referred to a slat position of 100 %. Positions temporarily approached will be stored also for those outputs that are involved in a travel movement at the time of data storage.
 On account of the fact that position data are stored as integer percentage values (rounding to 0...100), a minor deviation from the positions reported back later during scene recall cannot be avoided.
 The data are stored only if the mains voltage has been available before without interruption for at least 20 seconds after the last reset (storage capacitors sufficiently charged for storage purposes). The data will not be stored, if the position data are unknown.

Forced-position function (with 4/8-channel device variant only available with ETS3.0d and higher)

The forced position function can be enabled for blind output. The forced position has the second highest priority after manual control. It therefore overrides the safety function, the sun protection function and the direct operation (short-time, long-time telegram, scenes, positioning, central). During a forced-position state, the output concerned is locked so that it can no longer be controlled with functions of a lower priority, but only with a manual control. At the end of a manual control, the forced-position action is re-executed if the forced position is still active.

The forced position function has a separate 2-bit communication object for each output. The state of the output in case of a forced position function is directly determined by the forced-position telegram. The first bit (bit 0) of the "Forced position" object specifies the travel direction to be forced onto the output as in long-time operation. The second bit (bit 1) activates or deactivates the forced-position state (cf. following table).

Bit 1	Bit 0	Function
0	x	Forced position not active normal control
0	x	Forced position not active normal control
1	0	Forced position active, raising / opening the louver
1	1	Forced position active, lowering / closing the louver

Bit coding of forced position

The behaviour of an output at the end of the forced-position function can be parameterized. The forced-position object can moreover be initialized on return of bus voltage. A mains failure alone (bus voltage present) has no effect on the state of the forced-position object. In case of a return of only the mains voltage, a previously activated forced position remains active.

- i** The forced-position travel time required by an output to move the drive into the end positions is determined by the "Travel time" parameter on parameter page "Ax - Time settings" or by the travel time learnt in case of automatic end position detection. Like the long-time operation, a forced-position travel is derived from the travel time. Downward travel: travel time + 20 %; Upward travel: travel time + 20 % + parameterized or taught-in travel time extension. Forced-position travels are not retriggerable.
- i** The slats of blinds are not repositioned at the end of forced-position travels into the end positions.
- i** Updates of the forced position object from "forced position active" to "forced position active" while maintaining the forced travel direction or from "forced position inactive" to "forced position inactive" show no reaction.
- i** After programming of the application or of the parameters with the ETS, the forced position is always cancelled.

- i** The forced position function remains active even after a bus voltage failure as long as the mains voltage supply is still on. The forced position function will therefore be executed again at the end of a temporary or permanent manual control – if enabled in case of bus failure – even if there is no bus voltage.
- i** The current state of the forced position function will be stored in case of bus or mains voltage failure.

Enabling the forced position function

The forced position function can be enabled separately for each output.

- Set the parameter "Forced position function" on parameter page "Ax - Enabled functions" (x = number of output) to "enabled".
The forced position function is enabled. The corresponding communication object is created and the respective parameters on parameter page "Ax – Forced position" become visible.

Presetting the behaviour at the end of the forced position function

The behaviour of an output at the end of the forced-position function can be parameterized depending on the channel. The behaviour is parameterized on parameter page "Ax – Forced position" (x = number of output).

The forced position function of an output must be enabled on parameter page "Ax – Enabled functions" (x = number of output). Only then are the channel-related parameters for the forced position function visible.

- Set the parameter "Behaviour at the end of the forced position function" to "position tracking".
At the end of a forced position function, the output will be set to the state adjusted statically before the forced position function or to the state tracked and internally stored during the forced position function. The position objects, the long-time object and the scene function are tracked.
- Set the parameter "Behaviour at the end of the forced position function" to "no change".
At the end of forced position function, the state last adjusted will not be changed. Thereafter, the output is again enabled. Any travel movements still in progress at this instant will still be finished.

- i** Parameter setting "Position tracking": The blind actuator can track absolute positions (position telegram, scene value) during activated forced control only if the position data are known and if positions have been predefined. If this is not the case, no reaction takes place at the time forced control is enabled.
Position data can be tracked, if the output has been in a defined position before the forced position function or if a new position telegram has been received via the position objects while the forced position function was interlocked. In the latter case, a reference travel will be executed when the forced position function is enabled, if the position was unknown before or during the safety interlock.
Known slat positions will also be tracked as described. This is also the case, when the height of the blind is unknown.
Long-time travel movements (travels without position preset) will, however, always be tracked.
- i** The preset "Behaviour at the end of the forced position function" will only be executed, if the output passes over to direct operation at the end of the forced position function. If a safety function or a sun protection function is activated (independent of the preset priority with respect to direct operation), the function with the next lower priority will be executed. The parameterized behaviour will not be executed either if the forced position function is terminated by a preset on return of bus voltage. In this case, the preset "Behaviour after bus/mains voltage return" will be executed.

Presetting the behaviour of the forced position function after bus voltage return

The communication object of the forced position function can be initialized after bus voltage return. In this way, an output can be influenced and interlocked on bus initialization when the forced position function is being activated.

A mains failure alone has no effect on the forced position. In case of a return of only the mains voltage, a previously activated forced position remains active.

The behaviour after bus voltage return for the forced position function is parameterized separately for each output on the parameter pages

"Ax – Forced position" (x = number of output).

Depending on the selected mode of operation, the ETS adapts the designations of the parameter settings ("raising" ↔ "opening the louver" / "lowering" ↔ "closing the louver").

The parameterized state can be adopted into the "Forced position" communication object after bus return.

The forced position function of an output must be enabled on parameter page "Ax – Enabled functions (x = number of output). Only then are the channel-related parameters for the forced position function visible.

- Set the parameter "Behaviour after bus voltage return" to "no forced position active".
After bus voltage return, the forced position function is deactivated. In this case, the preset "Behaviour after bus/mains voltage return" will be executed on return of bus voltage.
- Set the parameter "Behaviour after bus voltage return" to "forced position function ON, raising" or "forced position function ON, opening the louver".
The forced position function is activated after bus voltage return and the curtain raised or the venting louver opened by forced control. The output concerned is interlocked by forced control until an enable signal is received via the bus. The parameter "Behaviour after bus voltage return" will in this case not be evaluated for the output concerned.
- Set the parameter "Behaviour after bus voltage return" to "forced position function ON, lowering" or "forced position function ON, closing the louver".
The forced position function is activated after bus voltage return and the curtain raised or the venting louver opened by forcing. The output concerned is interlocked by forced control until an enable signal is received via the bus. The parameter "Behaviour after bus voltage return" will in this case not be evaluated for the output concerned.
- Set the parameter "Behaviour after bus voltage return" to "state of forced position before bus/mains failure".
After bus voltage return, the forced-position state last selected and internally stored before bus or mains voltage failure will be tracked. An ETS programming operation deletes the stored state (reaction in that case same as with "no forced position active"). If the tracked state corresponds to "no forced position active", the parameter "Behaviour after bus/mains voltage return" will be executed on return of bus voltage.

i Setting or tracked state "no forced position active": The reaction of the output concerned after return of bus voltage is defined by the parameter "Behaviour after bus/mains voltage return".

i After programming of the application or of the parameters with the ETS, the forced position is always cancelled.

'Fabric-stretching' function

In the shutter/awning mode of operation, the Fabric-stretching function can be activated. The Fabric-stretching function permits stretching the fabric of an awning tight after lowering. The fabric-stretching function can also be used with shutters to re-open the slits of the shutter curtain after a downward movement into the lower end position.

If activated in the ETS parameters, fabric stretching is executed during each downward travel after stopping and after the parameterized changeover delay has elapsed. The curtain is then 'stretched' by moving briefly into the opposite travel direction (Figure 33).

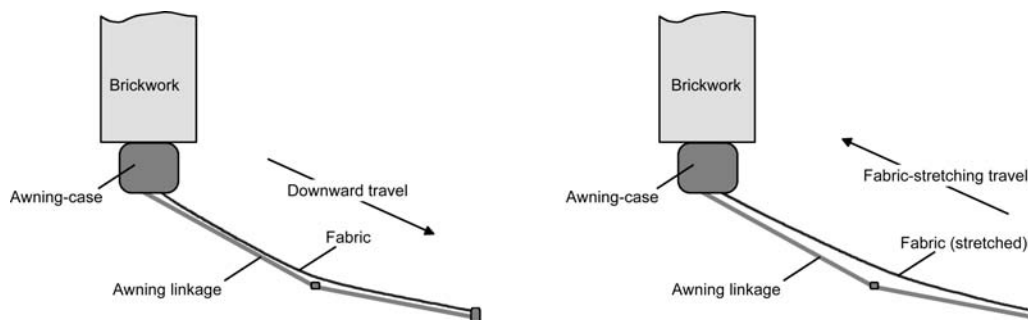

Figure 33: Fabric-stretching in an awning

The downward travel can be triggered by any of the following events: Long-time, short-time or position telegram, forced position, safety or sun protection function, central telegram or scene recall and also the manual control.

Sheet- stretching is never effected in upward travel movements.

- i** Fabric stretching affects the determination of positions and the position feedback since a fabric-stretching movement changes the position of a shutter or an awning. In a positioning move into the lower end position (100 %), the position value reported back after the fabric-stretching operation will always be a smaller one.
- i** Fabric-stretching cannot be parameterized in the blind or louver modes of operation.

Activating the fabric-stretching function

The fabric-stretching function can be activated independently for each shutter or awning output on parameter page "Ax – Enabled functions" (x = number of output).

The mode of operation selected must be the "Shutter/awning" mode.

- Set the parameter "Fabric-stretching function" to "enabled".
Parameter page "Ax – Fabric-stretching" is enabled and the fabric-stretching function is activated.

- i** Fabric-stretching cannot be parameterized in the blind or louver modes of operation.

Presetting the fabric-stretching function

The fabric-stretching function can be parameterized independently for each shutter or awning output on parameter page "Ax – Fabric-stretching" (x = number of output). The travel time required for fabric stretching by means of a movement in opposite direction can be parameterized.

The fabric-stretching function must be activated.

- Select the desired value for the "Time for fabric-stretching" parameter.
After the end of a downward travel the curtain stops and – after elapsing of the changeover delay – moves backwards in opposite direction for a period corresponding to the parameterized fabric-stretching time.

- i** The time for fabric stretching must be selected shorter than the parameterized or measured travel time of the shutter or awning. Otherwise, risk of malfunction.
- i** Fabric stretching will only be effected if the downward movement lasts longer than the parameterized fabric-stretching time.

4.2.4.3 Delivery state

In the as-delivered state, the actuator is passive, i.e. no telegrams are transmitted to the bus. The outputs can, however, be operated by manual control on the device, if the mains voltage is on. In the manual control mode, no feedback telegrams are sent to the bus. Other functions of the actuator are deactivated.

The device can be programmed and put into operation via the ETS. The physical address is preset to 15.15.255.

Moreover the device has been configured at the factory with the following characteristics...

- Venetian blind actuator 1/2-channel REG: 2-channel operation (230 V)
- Venetian blind actuator 2/4-channel REG: 4-channel operation (230 V)
- Venetian blind actuator 4/8-channel REG: 8-channel operation (230 V)
- No automatic end position detection
- Movement time (continuous run): 20 minutes
- Movement time extension: 2 %
- Break during movement direction changeover: 1 s
- Behaviour in case of bus voltage failure: no reaction
- Behaviour on bus or mains voltage return: Stop

4.2.5 Parameters

Description	Values	Comment
<input type="checkbox"/> General		
Channel definition	Two-channel (2 x 230 V AC) One-channel (1 x 24 V DC)	<p>This parameter defines how the channels are used. If 230 V AC drives are used, the device must be configured for 2-channel operation. Alternatively, the actuator must be set 1-channel operation when controlling a 12...48 V DC drive.</p> <p>i This parameter is only visible with the Venetian blind actuator 1/2-channel REG!</p>
Channel definition	four-channel (4 x 230 V AC) two-channel (2 x 24 V DC)	<p>This parameter defines how the channels are used. If 230 V AC drives are used, the device must be parameterized for 4-channel operation. Alternatively, the actuator must be set to 2-channel operation, if 12...48 V DC drives are used.</p> <p>i This parameter is only visible in blind actuator 2/4-channel REG!</p>
Channel definition	eight-channel (8 x 230 V AC) four-channel (4 x 24 V DC)	<p>This parameter defines how the channels are used. If 230 V AC drives are used, the device must be parameterized for 8-channel operation. Alternatively, the actuator must be set to 12-channel operation, if 48...2 V DC drives are used.</p> <p>i This parameter is only visible in blind actuator 4/8-channel REG!</p>
Delay after bus voltage return Minutes (0...59)	0...59	<p>To reduce telegram traffic on the bus line after bus voltage activation (bus reset), after connection of the device to the bus line or after programming with the ETS, it is possible to delay all active feedback telegrams of the actuator. The parameter specifies in this case a delay valid for all devices. Only after the time configured here has elapsed are feedback telegrams for initialisation transmitted to the bus.</p> <p>Setting the delay time minutes.</p>
Seconds (0...59)	0...17...59	Setting the delay time seconds.
Central function ?	Yes No	<p>Setting "yes" enables the central function and thus the "Central travel control" object. Individual blind outputs can be assigned to the central function only if the function is enabled.</p>
Central object polarity		

	<p>0 = UP; 1 = DOWN 0 = DOWN; 1 = UP</p>	<p>This parameter defines the polarity of the central object.</p>
<p>☐ Safety</p>		
Safety functions	<p>disabled enabled</p>	<p>If it is intended to make use of the 5 safety functions of the actuator and to parameterize them, the function must be enabled for all channels (setting "enabled"). If the safety functions are deactivated (setting: "disabled"), any programmed assignment of individual blind outputs to safety monitoring functions is not operational.</p>
Wind alarm 1	<p>disabled enabled</p>	<p>This parameter can be used to enable the first wind alarm and thus to enable the communication object (setting: "enabled"). If the first wind alarm is deactivated (setting: "disabled"), any programmed assignment of individual blind outputs to wind alarm 1 is not operational.</p>
Wind alarm 2	<p>disabled enabled</p>	<p>This parameter can be used to enable the second wind alarm and thus to enable the communication object (setting: "enabled"). If the first wind alarm is deactivated (setting: "disabled"), any programmed assignment of individual blind outputs to wind alarm 2 is not operational.</p>
Wind alarm 3	<p>disabled enabled</p>	<p>This parameter can be used to enable the third wind alarm and thus to enable the communication object (setting: "enabled"). If the third wind alarm is deactivated (setting: "disabled"), any programmed assignment of individual blind outputs to wind alarm 3 is not operational.</p>
Rain alarm	<p>disabled enabled</p>	<p>This parameter can be used to enable the rain alarm and thus to enable the communication object (setting: "enabled"). If the rain alarm is deactivated (setting: "disabled"), any programmed assignment of individual blind outputs to the rain alarm is not operational.</p>
Frost alarm	<p>disabled enabled</p>	<p>This parameter can be used to enable the frost alarm and thus to enable the communication object (setting: "enabled"). If the frost alarm is deactivated (setting: "disabled"), any programmed assignment of individual blind outputs to the frost alarm is not operational.</p>
Priority of safety alarms	<p>wind -> rain -> frost wind -> frost -> rain rain -> wind -> frost rain -> frost -> wind</p>	<p>This parameter defines the priority ranking of the individual safety alarms. Interpretation: high -> medium -> low.</p>

	frost -> rain -> wind frost -> wind -> rain		<ul style="list-style-type: none"> i The three wind alarms have the same priority with respect to one another. i The safety alarm enabling parameters and the priority parameter is only visible when the safety functions are enabled.
□ Safety times			
Use wind alarm monitoring function ? (only if wind alarms are enabled!)	Yes No		<p>If the wind alarms enabled under "Safety" are to be monitored cyclically for incoming telegrams to the safety objects, the monitoring function must be enabled here (setting: "yes"). In the opposite case (setting: "no"), the objects are not monitored cyclically.</p> <ul style="list-style-type: none"> i As soon as the monitoring function is activated, telegrams must be transmitted cyclically to all enabled wind alarm objects. i The monitoring function may only be activated, if at least one wind alarm has been activated under "Safety".
Time for monitoring wind alarm Hours (0...23)	0...23		<p>This parameter is used for programming the wind alarm monitoring time.</p> <p>Sets the monitoring time hours.</p>
Minutes (1...59)	1...25...59		<p>Sets the monitoring time minutes.</p> <p><i>Presetting: 25 minutes</i></p> <ul style="list-style-type: none"> i The cycle time of the transmitter should be less than half the parameterized monitoring time of the actuator. i The times can only be set, if wind alarm monitoring is activated.
Use rain alarm monitoring function ?	Yes No		<p>If the rain alarm enabled under "Safety" is to be monitored cyclically for incoming telegrams to the safety object, the monitoring function must be enabled here (setting: "yes"). In the opposite case (setting: "no"), the object is not monitored cyclically.</p> <ul style="list-style-type: none"> i As soon as the monitoring function is activated, telegrams must be transmitted cyclically to the enabled rain alarm object. i The parameter is only visible, if the rain alarm has been enabled under "Safety".
Time for monitoring rain alarm Hours (0...23)	0...23		<p>This parameter is used for programming the rain alarm monitoring time.</p> <p>Sets the monitoring time hours.</p>
Minutes (1...59)	1...2...59		<p>Sets the monitoring time minutes.</p>

			<i>Presetting: 2 minutes</i>
			<p>i The cycle time of the transmitter should be less than half the parameterized monitoring time of the actuator.</p> <p>i The times can only be set, if rain alarm monitoring is activated.</p>
Use frost alarm monitoring function ?	Yes No		<p>If the frost alarm enabled under "Safety" is to be monitored cyclically for incoming telegrams to the safety object, the monitoring function must be enabled here (setting: "yes"). In the opposite case (setting: "no"), the object is not monitored cyclically.</p> <p>i As soon as the monitoring function is activated, telegrams must be transmitted cyclically to the enabled frost alarm object.</p> <p>i The parameter is only visible, if the frost alarm has been enabled under "Safety".</p>
Time for monitoring frost alarm Hours (0...23)	0 ...23		<p>This parameter is used for programming the frost alarm monitoring time.</p> <p>Sets the monitoring time hours.</p>
Minutes (1...59)	1... 2 ...59		<p>Sets the monitoring time minutes.</p> <p><i>Presetting: 2 minutes</i></p> <p>i The cycle time of the transmitter should be less than half the parameterized monitoring time of the actuator.</p> <p>i The times can only be set, if frost alarm monitoring is activated.</p>
<input type="checkbox"/> Manual control			
Manual control in case of bus voltage failure	Disabled Enabled		<p>This parameter can be used for programming whether manual control is to be possible (enabled) or deactivated in case of bus voltage failure.</p>
Manual control during bus operation	Disabled Enabled		<p>This parameter can be used for programming whether manual control is to be possible (enabled) or deactivated during bus operation (bus voltage on).</p>
Disabling function ?	Yes No		<p>Manual control can be disabled via the bus, even if it is already active. For this purpose, the disabling object can be enabled here.</p>
Polarity of disable object	0 = enabled; 1 = disabled 0 = disabled; 1 = enabled		<p>This parameter sets the polarity of the disabling object.</p> <p>i Only visible if the disabling function for manual control is enabled.</p>
Transmit status ?	Yes No		<p>The current state of manual control can be transmitted to the bus via a separate</p>

Status object function and polarity

0 = inactive; 1 = manual control active

0 = inactive; 1 = permanent manual control active

status object, if bus voltage is available (setting: "Yes").

This parameter defines the information contained in the status object. The object is always "0", when the manual control mode is deactivated.

The object is "1" when the manual control mode is active (temporary or permanent).

The object is "1" only when the permanent manual control is active.

i This parameter is visible only if the manual control status transmission is enabled.

i After bus voltage return, the status will only be transmitted actively to the bus ("0") if a manual control was ended by the bus return.

Behaviour at the end of permanent manual control during bus operation

No change

The behaviour of the actuator at the end of permanent manual control depends on this parameter.

All telegrams received during an active permanent manual control mode for direct operation (long-time/short-time, positioning, scenes) are rejected. After the end of the permanent manual control mode, the current state of all outputs remains unchanged. If, however, a function with a higher priority is being activated during manual control (safety, forced position, sun protection), the actuator activates the higher-ranking function for the corresponding outputs.

output tracking

During an active permanent manual control all incoming telegrams (short-time telegrams excepted) are internally tracked. At the end of manual control, the outputs are adjusted accordingly.

Disable bus control of individual outputs during bus operation

Yes

No

Individual outputs can be disabled locally during permanent manual control, so that the disabled outputs can no longer be controlled via the bus. Disabling via manual control is only permitted if this parameter is set to "Yes".

□-Ax – General

(x = number of output / In 12...48 VDC operation, outputs 1 + 2, 3 + 4, 5 + 6 and 7 + 8 combined into pairs. / All outputs can be parameterized independently).

Mode of operation (to be adjusted first!)

blind

shutter / awning

venting louver

The blind actuator can be used to control different drive systems. This parameter defines which type of drive or which type of curtain is connected to the output.

Behaviour after ETS programming

- i** The ETS adapts all of the following parameters (designations, visible/non visible, etc.) dynamically to the respective "mode of operation" parameter. For this reason, the "Mode of operation" parameter should be adjusted before all other parameters of an output.

The actuator permits setting the preferred relay contact position after ETS programming separately for each output.

Raising / opening the louvre

After programming with the ETS, the actuator raises the blind or opens the venting louvre.

Lowering / closing the louvre

After programming with the ETS, the actuator lowers the blind or closes the venting louvre.

Stop

After programming with the ETS, the actuator switches the relays of the output to the "stop" position. A drive movement, if any, will be interrupted.

- i** The configured behaviour will be executed after every application or parameter download by the ETS. A simple download of the physical address alone or partial programming of only the group addresses has the effect that this parameter is disregarded and that the configured "Behaviour after bus/mains voltage-return" will be executed instead.

Behaviour in case of bus voltage failure

The actuator permits setting the preferred relay contact position in case of bus voltage failure separately for each output.

Stop

In case of bus voltage failure, the actuator switches the relays of the output to the "stop" position. A drive movement, if any, will be interrupted.

Raising / opening the louvre

After bus voltage failure, the actuator raises the blind or opens the venting louvre.

Lowering / closing the louvre

After bus voltage failure, the actuator lowers the blind or closes the venting louvre.

Approaching a position

In case of bus voltage failure, the connected drive can approach a position specified by further parameters.

No reaction

In the event of bus voltage failure, the relay of the output shows no reaction. Any drive movements still in progress at the time of failure will be completely finished.

Position of Venetian blind in case of bus voltage failure (0...100%)	0...100	<p>i The configured behaviour will only be executed, if no manual control is activated.</p>
Position of slat in case of bus voltage failure (0...100%)	0...100	<p>This parameter specifies the Venetian blind position to be approached in case of bus voltage failure.</p> <p>i This parameter is only visible, if "Behaviour in case of bus voltage failure" is set to "approach position".</p> <p>i This parameter is only visible in the Venetian blind operating mode.</p> <p>This parameter specifies the slat position to be approached in case of bus voltage failure after the Venetian blind has been positioned at the desired height.</p>
Position of roller shutter/awning in case of bus voltage failure (0...100%)	0...100	<p>i This parameter is only visible, if "Behaviour in case of bus voltage failure" is set to "approach position".</p> <p>i This parameter is only visible in the Venetian blind operating mode.</p> <p>This parameter specifies the roller shutter or awning position to be approached in case of bus voltage failure.</p> <p>i This parameter is only visible, if "Behaviour in case of bus voltage failure" is set to "approach position".</p> <p>i This parameter is only visible in the roller shutter/awning operating mode.</p>
Position of venting louvre in case of bus voltage failure (0...100%)	0...100	<p>This parameter specifies the venting louvre position to be approached in case of bus voltage failure.</p> <p>i This parameter is only visible, if "Behaviour in case of bus voltage failure" is set to "approach position".</p> <p>i This parameter is visible only in the 'Venting louvre' operating mode.</p>
Behaviour after bus or mains voltage return	Stop	<p>The actuator permits setting the preferred relay contact position after mains voltage return separately for each output. This means that the configured behaviour is executed when either the bus or the mains voltage is switched on again.</p>
Raising / opening the louvre		<p>In case of bus or mains voltage return, the actuator switches the relays of the output to the "stop" position. A drive movement, if any, will be interrupted.</p> <p>After bus or mains voltage return, the actuator raises the curtain or opens the venting louvre.</p>

	Lowering / closing the louvre	After bus or mains voltage return, the actuator lowers the curtain or closes the venting louvre.
	Position during bus/mains failure	After bus or mains voltage return, the state last existing and internally stored <u>before</u> bus or mains voltage failure will be tracked.
	Approaching a position	On bus or mains voltage return, the connected drive can travel to a position specified by other parameters.
	No reaction	In the event of bus or mains voltage return, the relay of the output shows no reaction. Any drive movements still in progress at the time of failure will be completely finished. The reactions active at the time of mains failure are re-executed on return of the mains supply. Interrupted short or long time travel movements are restarted at full length and position approaches are continued from the point of interruption.
		<p>i The configured behaviour will only be executed, if no forced position on bus voltage return is activated.</p>
Venetian blind position on bus/mains voltage return (0...100%)	0...100	<p>This parameter specifies the Venetian blind position to be approached in case of bus or mains voltage return.</p> <p>i This parameter is only visible, if "Behaviour in case of bus or mains-voltage return" is set to "approach position".</p> <p>i This parameter is only visible in the Venetian blind operating mode.</p>
Slat position on bus/ mains voltage return (0...100%)	0...100	<p>This parameter specifies the slat position to be approached in case of bus or mains voltage return after the Venetian blind has been positioned at the desired height.</p> <p>i This parameter is only visible, if "Behaviour in case of bus or mains-voltage return" is set to "approach position".</p> <p>i This parameter is only visible in the Venetian blind operating mode.</p>
Roller shutter/awning position on bus/mains voltage return (0...100%)	0...100	<p>This parameter specifies the roller shutter or awning position to be approached in case of bus or mains voltage return.</p> <p>i This parameter is only visible, if "Behaviour in case of bus or mains-voltage return" is set to "approach position".</p> <p>i This parameter is only visible in the roller shutter/awning operating mode.</p>

Position of venting louvre on return of bus/ mains voltage (0...100%)	0...100	This parameter specifies the venting louvre position to be approached in case of bus or mains voltage return. <ul style="list-style-type: none"> i This parameter is only visible, if "Behaviour in case of bus or mains- voltage return" is set to "approach position". i This parameter is visible only in the 'Venting louvre' operating mode.
Travelling time extension for upward travel	2 % 3 % 4 % 5 % 6 % 7 % 8 % 9 % 10 % 12.5 %	The blind actuator prolongs all upward movements or venting louver movements into the open position based on the time extension specified in this parameter. The time extension expressed in percent is the difference between the measured travel time needed to reach the lower end position (completely closed position) and the time needed to reach the upper end position (completely open position). <ul style="list-style-type: none"> i This parameter is only visible, when the automatic end position detection is not deactivated.
<input type="checkbox"/> "Ax - Time settings" (x = number of output / In 12...48 VDC operation, outputs 1 + 2, 3 + 4, 5 + 6 and 7 + 8 combined into pairs. / All outputs can be parameterized independently).		
Automatic end position detection ?	Yes No	This parameter specifies whether the travel time of the curtain or of the venting louver is determined automatically by the actuator (detection of the end positions of the drive) or specified as a fixed value in a parameter.
Short time operation	No (only stop) Yes	This parameter can be used to configure the reaction to a received short time telegram. <p>The drive will only be stopped if it is executing a movement at the time of telegram reception. There is no reaction if no movement is in progress.</p> <p>Short-time operation is started on reception of a short-time telegram when the drive is stationary. If the drive is in motion at the time of telegram reception, it will be stopped.</p>
Time for short time operation Seconds (0...59)	0...2...59	This parameter defines the duration of short-time operation. <p>Sets the monitoring time seconds.</p>
Milliseconds (0...99 x 10)	0...99	Sets the monitoring time milliseconds. <p><i>Presetting: 2 seconds</i></p> <ul style="list-style-type: none"> i The duration of short time operation should in no case exceed half the slat adjusting time.

			<p>i This parameter is only visible, if the parameter "Short time operation" is set to "yes".</p>
Blind travelling time Minutes (0...19)	0...1...19		<p>This parameter defines the travelling time of the blind. The time needed for a complete travel from the upper into the lower end position must be determined.</p> <p>Sets the minutes of the blind travelling time.</p>
Seconds (0...59)	0...40...59		<p>Sets the seconds of the blind travelling time.</p> <p><i>Presetting: 40 seconds</i></p> <p>i The travelling time must be determined precisely.</p> <p>i The travelling time parameters are only visible when the automatic end position detection is not enabled.</p> <p>i These parameters are visible only in the 'Blind' mode of operation.</p>
Shutter/awning travelling time Minutes (0...19)	0...1...19		<p>This parameter defines the travelling time of the shutter or awning. The time needed for a complete travel from the upper into the lower end position must be determined.</p> <p>Sets the minutes of the shutter or awning travelling time.</p>
Seconds (0...59)	0...40...59		<p>Sets the seconds of the shutter or awning travelling time.</p> <p><i>Presetting: 40 seconds</i></p> <p>i The travelling time must be determined precisely.</p> <p>i The travelling time parameters are only visible when the automatic end position detection is not enabled.</p> <p>i These parameters are visible only in the 'Shutter/awning' mode of operation.</p>
Venting louver travelling time Minutes (0...19)	0...1...19		<p>This parameter defines the travelling time of the venting louver. The time needed for a complete travel from the completely open into the completely closed position must be determined.</p> <p>Sets the minutes of the venting louver travelling time.</p>
Seconds (0...59)	0...40...59		<p>Sets the seconds of the venting louver travelling time.</p> <p><i>Presetting: 40 seconds</i></p> <p>i The travelling time must be determined precisely.</p>

		<p>i The travelling time parameters are only visible when the automatic end position detection is not enabled.</p> <p>i These parameters are visible only in the 'Venting louver' mode of operation.</p>
Slat moving time Minutes (0...19)	0...19	<p>This parameter defines the travelling time of the slats. The time needed for a complete travel movement from the completely open slat position into the completely closed slat position (downward direction) must be determined.</p> <p>Sets the minutes of the slat moving time.</p>
Seconds (0...59)	0...5...59	<p>Sets the seconds of the slat moving time.</p> <p><i>Presetting: 5 seconds</i></p> <p>i The travelling time must be determined precisely.</p> <p>i The slat moving time must be selected shorter than the blind travelling time.</p> <p>i These parameters are visible only in the 'Blind' mode of operation.</p>
Change-over time for travel direction changes	0.5 s 1 s 2 s 5 s	<p>Defines the break during a change of travel direction (change-over time).</p>
<p><input type="checkbox"/> Ax – Enabled functions (x = number of output / In 12...48 VDC operation, outputs 1 + 2, 3 + 4, 5 + 6 and 7 + 8 combined into pairs. / All outputs can be parameterized independently).</p>		
Feedback functions	disabled enabled	<p>This parameter can be used to disable or to enable the feedback functions. When the function is enabled, the required parameters will be displayed under "Ax –Feedbacks".</p>
Safety functions	disabled enabled	<p>This parameter can be used disable or to enable the safety functions. When the function is enabled, the required parameters will be displayed under "Ax –Safety".</p>
Sun protection functions	disabled enabled	<p>This parameter can be used disable or to enable the sun protection functions. When the function is enabled, the corresponding parameters will be displayed under "Ax - Sun protection" (3 parameter nodes) and the necessary objects enabled.</p>
Scene function	disabled enabled	<p>This parameter can be used disable or to enable the scene function. When the function is enabled, the corresponding parameters will be displayed under "Ax - Scenes" and the necessary object enabled.</p>

Forced position function	disabled enabled	This parameter can be used to disable or to enable the forced position function. When the function is enabled, the corresponding parameters will be displayed under "Ax - Forced position" and the necessary object enabled.
Fabric-stretching function	disabled enabled	This parameter can be used disable or to enable the fabric-stretching function. When the function is enabled, the corresponding parameters will be displayed under "Ax - Fabric-stretching" and the necessary object enabled. i This parameter is visible only in the 'Shutter/awning' mode of operation.
Assignment to central function ?	yes (enable central function under "General") No	This parameter determines the assignment of the output to the central function. The output is assigned to the central function. The central function is supposed to have been enabled under "General". The assignment has otherwise no effect on the blind output. The output is not assigned to the central function.
<p>□-Ax – Feedbacks (x = number of output / In 12...48 VDC operation, outputs 1 + 2, 3 + 4, 5 + 6 and 7 + 8 combined into pairs.)</p>		
Venetian blind position feedback	No feedback Feedback object is active signalling object Feedback object is passive status object	The current Venetian blind position of the output can be reported separately back to the bus. No feedback object available for the output. Feedback deactivated. Feedback and the object are activated. The object transmits actively (telegram transmission after change). Feedback and the object are activated. The object is passive (telegram transmission only as a response to 'Read' request). i The communication flags of the object are automatically set by the ETS according to the setting. i This parameter is only visible in the Venetian blind operating mode.
Roller shutter/awning position feedback	No feedback Feedback object is active signalling object	The current roller shutter or awning position of the output can be reported separately back to the bus. No feedback object available for the output. Feedback deactivated. Feedback and the object are activated. The object transmits actively (telegram transmission after change).

	Feedback object is passive status object	Feedback and the object are activated. The object is passive (telegram transmission only as a response to 'Read' request). <ul style="list-style-type: none"> i The communication flags of the object are automatically set by the ETS according to the setting. i This parameter is only visible in the roller shutter/awning operating mode.
Venting louvre position feedback	No feedback	The current venting louvre position of the output can be reported separately back to the bus. No feedback object available for the output. Feedback deactivated.
	Feedback object is active signalling object	Feedback and the object are activated. The object transmits actively (telegram transmission after change).
	Feedback object is passive status object	Feedback and the object are activated. The object is passive (telegram transmission only as a response to 'Read' request). <ul style="list-style-type: none"> i The communication flags of the object are automatically set by the ETS according to the setting. i This parameter is visible only in the 'Venting louvre' operating mode.
Time delay for feedback telegram after bus voltage return ?	Yes (delay time under "General") No	The feedback telegram can be transmitted to the bus with a delay after bus voltage return or after programming with the ETS. Setting "Yes" activates the delay time of the feedback in case of bus voltage return. The delay time is configured under "General". <ul style="list-style-type: none"> i This parameter is only visible in case of an actively transmitting feedback object.
Slat position feedback	No feedback	The current slat position of the output can be reported separately back to the bus. No feedback object available for the output. Feedback deactivated.
	Feedback object is active signalling object	Feedback and the object are activated. The object transmits actively (telegram transmission after change).
	Feedback object is passive status object	Feedback and the object are activated. The object is passive (telegram transmission only as a response to 'Read' request). <ul style="list-style-type: none"> i The communication flags of the object are automatically set by the ETS according to the setting.

Time delay for feedback telegram after bus voltage return ?	Yes (delay time under "General") No	<p>i This parameter is only visible in the Venetian blind operating mode.</p> <p>The feedback telegram can be transmitted to the bus with a delay after bus voltage return or after programming with the ETS. Setting "Yes" activates the delay time of the feedback in case of bus voltage return. The delay time is configured under "General".</p>
Invalid Venetian blind position feedback	No feedback	<p>i This parameter is only visible in case of an actively transmitting feedback object.</p> <p>The actuator can report to the bus that the current blind position is unknown (e.g. after an initialisation, when no reference travel has been executed as yet).</p>
	Feedback object is active signalling object	<p>No feedback object available for the output. Feedback deactivated.</p> <p>Feedback and the object are activated. The object transmits actively (telegram transmission after change).</p>
	Feedback object is passive status object	<p>Feedback and the object are activated. The object is passive (telegram transmission only as a response to 'Read' request).</p>
Invalid roller shutter/awning position feedback	No feedback	<p>i The communication flags of the object are automatically set by the ETS according to the setting.</p> <p>i This parameter is only visible in the Venetian blind operating mode.</p> <p>The actuator can report to the bus that the current roller shutter/awning position is unknown (e.g. after an initialisation, when no reference travel has been executed as yet).</p>
	Feedback object is active signalling object	<p>No feedback object available for the output. Feedback deactivated.</p> <p>Feedback and the object are activated. The object transmits actively (telegram transmission after change).</p>
	Feedback object is passive status object	<p>Feedback and the object are activated. The object is passive (telegram transmission only as a response to 'Read' request).</p>
Invalid venting louvre position feedback		<p>i The communication flags of the object are automatically set by the ETS according to the setting.</p> <p>i This parameter is only visible in the roller shutter/awning operating mode.</p> <p>The actuator can report to the bus that the current venting louvre position is unknown (e.g. after an initialisation,</p>

		when no reference travel has been executed as yet).
	No feedback	No feedback object available for the output. Feedback deactivated.
	Feedback object is active signalling object	Feedback and the object are activated. The object transmits actively (telegram transmission after change).
	Feedback object is passive status object	Feedback and the object are activated. The object is passive (telegram transmission only as a response to 'Read' request).
		<ul style="list-style-type: none"> i The communication flags of the object are automatically set by the ETS according to the setting. i This parameter is visible only in the 'Venting louvre' operating mode.
Time delay for feedback telegram after bus voltage return ?	Yes (delay time under "General!")	The feedback telegram can be transmitted to the bus with a delay after bus voltage return or after programming with the ETS. Setting "Yes" activates the delay time of the feedback in case of bus voltage return. The delay time is configured under "General".
	No	<ul style="list-style-type: none"> i This parameter is only visible in case of an actively transmitting feedback object.
Drive movement feedback		The actuator can report to the bus that the connected drive is active, i.e. the output is supplying power to the drive for a travel direction.
	No feedback	No feedback object available for the output. Feedback deactivated.
	Feedback object is active signalling object	Feedback and the object are activated. The object transmits actively (telegram transmission after change).
	Feedback object is passive status object	Feedback and the object are activated. The object is passive (telegram transmission only as a response to 'Read' request).
		<ul style="list-style-type: none"> i The communication flags of the object are automatically set by the ETS according to the setting.
Time delay for feedback telegram after bus voltage return ?	Yes (delay time under "General!")	The feedback telegram can be transmitted to the bus with a delay after bus voltage return or after programming with the ETS. Setting "Yes" activates the delay time of the feedback in case of bus voltage return. The delay time is configured under "General".
	No	<ul style="list-style-type: none"> i This parameter is only visible in case of an actively transmitting feedback object.

□-Ax – Safety

(x = number of output / In 12...48 VDC operation, outputs 1 + 2, 3 + 4, 5 + 6 and 7 + 8 combined into pairs.)

Assignment to wind alarms	<p>No</p> <p>Wind alarm 1</p> <p>Wind alarm 2</p> <p>Wind alarm 3</p> <p>Wind alarm 1 + 2</p> <p>Wind alarm 1 + 3</p> <p>Wind alarm 2 + 3</p> <p>Wind alarm 1 + 2 + 3</p>	<p>This parameter defines whether the output responds to a wind alarm and to which of the alarms.</p>
Behaviour in case of wind alarm	<p>no reaction</p> <p>raising / opening the louver</p> <p>raising / closing the louver</p> <p>stop</p>	<p>This parameter defines the behaviour of the output at the beginning of a wind alarm.</p> <p>At the beginning of the wind alarm or wind alarms, the output is interlocked and the relay of the output shows no reaction. Any travel movements in progress at this instant will still be completely finished.</p> <p>The actuator raises the curtain or opens the venting louver at the beginning of the wind alarm or wind alarms and locks the output thereafter.</p> <p>The actuator lowers the curtain or closes the venting louver at the beginning of the wind alarm or wind alarms and locks the output thereafter.</p> <p>At the beginning of the wind alarm or wind alarms, the actuator switches the relays of the output to "stop" and locks the output. A travel movement, if any, will be interrupted.</p> <p>i The behaviour preset in this parameter will be executed when one of the assigned wind alarms is activated.</p> <p>i This parameter is only visible, if the output has been assigned to at least one wind alarm.</p>
Assignment to rain alarm	<p>Yes</p> <p>No</p>	<p>This parameter defines whether the output responds to the rain alarm.</p>
Behaviour in case of rain alarm	<p>no reaction</p>	<p>This parameter defines the behaviour of the output at the beginning of the rain alarm.</p> <p>At the beginning of the rain alarm, the output is interlocked and the relay of the</p>

		output shows no reaction. Any travel movements in progress at this instant will still be completely finished.
	raising / opening the louver	The actuator raises the curtain or opens the venting louver at the beginning of the rain alarm and locks the output thereafter.
	raising / closing the louver	The actuator lowers the curtain or closes the venting louver at the beginning of the rain alarm and locks the output thereafter.
	stop	At the beginning of the rain alarm, the actuator switches the relays of the output to "stop" and locks the output. A travel movement, if any, will be interrupted.
		i This parameter is only visible, if the output has been assigned to the rain alarm.
Assignment to frost alarm	Yes No	This parameter defines whether the output responds to the frost alarm.
Behaviour in case of frost alarm	no reaction	This parameter defines the behaviour of the output at the beginning of the frost alarm. At the beginning of the frost alarm, the output is interlocked and the relay of the output shows no reaction. Any travel movements in progress at this instant will still be completely finished.
	raising / opening the louver	The actuator raises the curtain or opens the venting louver at the beginning of the frost alarm and locks the output thereafter.
	raising / closing the louver	The actuator lowers the curtain or closes the venting louver at the beginning of the frost alarm and locks the output thereafter.
	stop	At the beginning of the frost alarm, the actuator switches the relays of the output to "stop" and locks the output. A travel movement, if any, will be interrupted.
		i This parameter is only visible, if the output has been assigned to the frost alarm.
Behaviour at the end of safety (wind, rain, frost)	no reaction	This parameter defines the behaviour of the output at the end of all safety functions. At the end of the safety functions, the output is unlocked and the relay of the output shows no reaction. Any travel movements still in progress at this instant will still be finished.

raising / opening the louver	The actuator unlocks the output at the end of all safety alarms and raises the curtain or opens the venting louver.
raising / closing the louver	The actuator unlocks the output at the end of the safety functions and lowers the curtain or closes the venting louver.
stop	At the end of the safety functions, the output is unlocked and the actuator switches the relays of the output into the "stop" position. A travel movement, if any, will be interrupted.
tracking the position	At the end of safety, the output will be set to the state last adjusted before the safety function or to the state tracked and internally stored during the safety function. The position objects, the long-time object and the scene function are tracked. <div style="border: 1px solid black; padding: 2px; display: inline-block;"> <p>i The behaviour preset in this parameter will only be executed, if the output passes over to direct operation at the end of safety. Direct operation will be executed when a sun protection function is active.</p> </div>
<p>☐ Ax – Sun protection (x = number of output / In 12...48 VDC operation, outputs 1 + 2, 3 + 4, 5 + 6 and 7 + 8 combined into pairs.)</p>	
Type of sun protection	This parameter defines the scope of sun protection functions.
simple sun protection	Reduced scope of functions with standard configuration possibilities.
enlarged sun protection mode	Enlarged scope of functions including the possibilities of the simple sun protection. In addition, the connected drive can be integrated in shading control systems depending on the position of the sun. Automatic heating/cooling can also be realized.
Priority of sun protection with respect to direct operation	This parameter defines the priority of the sun protection function with respect to direct operation.
same priority	The sun protection can be overridden by direct operation and vice versa. Only after the next reception of a "sun is shining" signal will the sun protection mode be activated again.
higher priority	The sun protection has the higher priority and cannot be aborted by a direct operation.
Lower priority	The direct operation has the higher priority and cannot be aborted by sun protection. The sun protection can be

<p>Priority of automatic operation with respect to direct operation</p>	<p>same priority</p> <p>higher priority</p> <p>Lower priority</p>	<p>activated only after an enabling movement into the upper end position initiated by a direct operation has occurred without interruption.</p> <p>i Direct operation = long-time/short-time operation; Positioning via objects, scenes, central control.</p> <p>i This parameter is only visible in the simple sun protection.</p> <p>This parameter defines the priority of automatic operation with respect to direct operation. The selected priority affects the evaluation of the sunshine signal in the automatic mode and not the automatic mode itself.</p> <p>The evaluation of the sunshine signal in the automatic mode can be overridden by a direct operation. In the same way, a direct operation is overridden by the reception of a new sunshine telegram.</p> <p>The automatic mode has the higher priority and cannot be aborted by a direct operation irrespective of the state of the sunshine signal. A direct operation will be possible again only after the automatic mode is terminated.</p> <p>The direct operation has the higher priority and cannot be aborted by a sunshine signal in the automatic mode. The sunshine signal is evaluated again only after an enabling movement into the upper end position initiated by a direct operation has occurred without interruption and only if the automatic mode is activated and not disabled at this time.</p> <p>i Direct operation = long-time/short-time operation; Positioning via objects, scenes, central control.</p> <p>i This parameter is only visible in the extended sun protection.</p>
<p>Polarity of the "Sunshine / shading facade" object</p>	<p>sunshine = 1; no sunshine = 0</p> <p>Sunshine = 0; no sunshine = 1</p>	<p>This parameter defines the polarity of the input object "Sunshine / shading facade" of the sun protection.</p>
<p>Activation of automatic operation via...</p>	<p>Object "Automatic" & next change of state</p>	<p>This parameter defines how to activate the automatic mode and the reactions resulting from such activation.</p> <p>Automatic operation is activated as soon as the "Automatic" object is set to 'active' in consideration of polarity. A reaction at the output occurs, however, only after a new change of state has</p>

		<p>been signalled via the "Sunshine / shading facade" object. In this case, the new state (beginning of sun protection or end of sun protection) determines the behaviour of the output.</p> <p>Automatic operation is activated as soon as the "Automatic" object receives a "1" telegram. The state of the object "Sunshine / shading facade" immediately determines the behaviour of the output (beginning of sun protection, end of sun protection).</p> <p>i The reception of a telegram 'Automatic mode inactive' at the "Automatic" object immediately ends the automatic mode in both cases. The behaviour is in this case defined by the parameter "Reaction at the end of automatic operation".</p>
	object "Automatic" & immediate tracking	
Polarity of "Automatic" object	<p>Automatic mode: activated = 1; deactivated = 0</p> <p>Automatic mode: activated = 0; deactivated = 1</p>	<p>This parameter defines the polarity of the automatic object.</p> <p>i This parameter is only visible, if the parameter "Activation of automatic operation via..." is set to "automatic" & next change of state".</p>
Disabling function for automatic mode ?	<p>Yes</p> <p>No</p>	<p>The automatic mode can be disabled. When disabling is active, the automatic mode is aborted. It can only be reactivated, if a "1" is written into the "Automatic" object. The objects "Automatic" and "Automatic mode disable" are logically combined (AND with feedback).</p> <p>The "Yes" setting enables the disabling function and makes the disabling object visible.</p> <p>i This parameter is only visible, if the parameter "Activation of automatic operation via..." is set to "object automatic & immediate tracking".</p>
Polarity of "Automatic mode disable" object	<p>Automatic mode: enabled = 1; disabled = 0</p> <p>Automatic mode: enabled = 0; disabled = 1</p>	<p>This parameter defines the polarity of the automatic mode disable object. Disabling is active when a telegram with polarity 'disabled' is received.</p> <p>i This parameter is only visible, if the parameter "Disabling function for automatic mode ?" is set to "Yes".</p>
Disabling function for direct operation ?	<p>Yes</p> <p>No</p>	<p>Direct operation can be disabled. When disabling is active, a direct operation can – independently of the preset priority – never abort a sun protection function. In this case, direct operation is disabled in other functions, too.</p> <p>The "Yes" setting enables the disabling function and makes the disabling object visible.</p>

Polarity of "Direct operation disable" object	<p>Automatic mode: enabled = 1; disabled = 0</p> <p>Automatic mode: enabled = 0; disabled = 1</p>	<p>i Direct operation = long-time/short-time operation; Positioning via objects, scenes, central control.</p> <p>This parameter defines the polarity of the disabling object for direct operation. Disabling is active when a telegram with polarity 'disabled' is received.</p> <p>i This parameter is only visible, if the parameter "Direct operation disable?" is set to "Yes".</p>
Reaction at the end of automatic operation	<p>no reaction</p> <p>raising / opening the louver</p> <p>raising / closing the louver</p> <p>stop</p> <p>tracking the position</p>	<p>This parameter defines the behaviour of the output at the end of automatic operation and also at the beginning of an automatic operation disable.</p> <p>At the end of automatic operation, the sun protection function is ended and the relay of the output shows no reaction. Any travel movements still in progress at this instant will still be finished.</p> <p>At the end of automatic operation, the actuator terminates the sun protection and raises the curtain or opens the venting louver.</p> <p>At the end of automatic operation, the actuator terminates the sun protection and lowers the curtain or closes the venting louver.</p> <p>At the end of automatic operation the sun protection is terminated and the actuator switches the relays of the output to "stop". A travel movement, if any, will be interrupted.</p> <p>At the end of automatic operation, the output will be set to the state last adjusted before the automatic sun protection or to the state tracked and internally stored during the automatic sun protection. The position objects, the long-time object and the scene function are tracked.</p> <p>i The behaviour preset in this parameter will only be executed, if no function with a higher priority (e.g. safety) is activated at the end of automatic operation.</p>
<p>☐Ax – Beginning of sun protection (x = number of output / In 12...48 VDC operation, outputs 1 + 2, 3 + 4, 5 + 6 and 7 + 8 combined into pairs.)</p>	<p>Time delay beginning of sunshine / shading Minutes (0...59)</p>	<p>The telegram received via the object "Sunshine / shading facade " for activation of shading (according to polarity) can be evaluated with a time delay.</p> <p>Setting the minutes of the delay time.</p>

Seconds (0...59)	0... 30 ...59	Setting the delay time seconds. <i>Presetting: 30 seconds</i>
		i A time setting of "0" in the parameters deactivates the respective delay time. In this case, the state of shading is evaluated immediately.
Reaction at the beginning of sunshine / shading		This parameter defines the behaviour of the output at the beginning of shading – if applicable, after the end of the delay time.
	No reaction	At the beginning of shading, the output switches over to sun protection while the relays of the output show no reaction. Any movements still in progress at this instant will still be finished.
	Raising	At the beginning of shading, the actuator raises the blind.
	Lowering	At the beginning of shading, the actuator lowers the blind.
	Stop	At the beginning of shading, the actuator switches the relays of the output to the "stop" position. A drive movement, if any, will be interrupted.
	Internal scene recall	At the beginning of sun shading, the Venetian blind actuator recalls the position values set in the scene configuration for the appropriate output. This is not a scene recall as in direct operation, but only an approach of the corresponding scene position values.
	Venetian blind or slat position fixed	At the beginning of shading, the output controls the approach to a configured fixed Venetian blind and slat position.
	Venetian blind position fixed / slat position variable	At the beginning of shading, the output controls the approach to a configured fixed Venetian blind position and to slat position preset by a separate object and thus variable.
	Slat position fixed / Venetian blind position variable	At the beginning of shading, the output controls the approach to a configured fixed slat position and to a Venetian blind position preset by a separate object and thus variable.
	Venetian blind and slat position variable	At the beginning of shading, the output controls the approach to the Venetian blind and slat positions preset by two separate objects and thus variable.
		i This parameter is visible only in the "Venetian blind" operating mode.
Reaction at the beginning of sunshine / shading		This parameter defines the behaviour of the output at the beginning of shading –

		if applicable, after the end of the delay time.
	No reaction	At the beginning of shading, the output switches over to sun protection while the relays of the output show no reaction. Any movements still in progress at this instant will still be finished.
	Raising	At the beginning of shading, the actuator raises the blind.
	Lowering	At the beginning of shading, the actuator lowers the blind.
	Stop	At the beginning of shading, the actuator switches the relays of the output to the "stop" position. A drive movement, if any, will be interrupted.
	Internal scene recall	At the beginning of sun shading, the Venetian blind actuator recalls the position values set in the scene configuration for the appropriate output. This is not a scene recall as in direct operation, but only an approach of the corresponding scene position values.
	Fixed roller shutter / awning position	At the beginning of shading, the output controls the approach to a configured fixed roller shutter / awning position.
	Roller shutter / awning position variable	At the beginning of shading, the output controls the approach to the roller shutter / awning position preset by a separate object and thus variable.
		i This parameter is visible only in the "Roller Shutter / Awning" operating mode.
Reaction at the beginning of sunshine / shading		This parameter defines the behaviour of the output at the beginning of shading – if applicable, after the end of the delay time.
	No reaction	At the beginning of shading, the output switches over to sun protection while the relays of the output show no reaction. Any movements still in progress at this instant will still be finished.
	Opening the louvre	At the beginning of shading, the actuator opens the venting louvre.
	Closing the louvre	At the beginning of shading, the actuator closes the venting louvre.
	Stop	At the beginning of shading, the actuator switches the relays of the output to the "stop" position. A drive movement, if any, will be interrupted.
	Internal scene recall	At the beginning of sun shading, the Venetian blind actuator recalls the position values set in the scene configuration for the appropriate output.

			<p>This is not a scene recall as in direct operation, but only an approach of the corresponding scene position values.</p>
	Fixed venting louvre position		<p>At the beginning of shading, the output controls the approach to a configured fixed venting louvre position.</p>
	Venting louvre position variable		<p>At the beginning of shading, the output controls the approach to the venting louvre position preset by a separate object and thus variable.</p>
Scene number (1...8)	1...8		<p>i This parameter is visible only in the "Venting louvre" operating mode.</p> <p>This parameter defines the number of the internal scene which is recalled at the beginning of shading.</p> <p>i This parameter is only visible, if the parameter "Reaction at the beginning of sunshine / shading" is set to "internal scene recall".</p>
Fixed Venetian blind position			<p>The fixed Venetian blind position at the beginning of shading can either be preset statically by a separate parameter or basically adjusted to the value prevailing at the time of shading activation, i.e. remain unchanged.</p>
	Same as configured value		<p>At the beginning of shading, the configured Venetian blind position value will be approached.</p>
	No change in current position		<p>At the beginning of shading, the current position of the Venetian blind will be maintained. In this case, the output behaves as if only the slat were positioned as a result of shading.</p> <p>i This parameter is only visible, if the Venetian blind is to approach a fixed position at the beginning of shading.</p> <p>i This parameter is visible only in the "Venetian blind" operating mode.</p>
Venetian blind position (0...100 %)	0... 50 ...100		<p>This parameter sets the fixed position of the Venetian blind to be approached at the beginning of shading.</p> <p>i This parameter is only visible, if the parameter "Fixed position of Venetian blind" is set to "as specified by parameter".</p> <p>i This parameter is visible only in the "Venetian blind" operating mode.</p>
Fixed slat position (0...100 %)	0... 50 ...100		<p>This parameter sets the fixed position of the slat to be approached at the beginning of shading and, as the case may be, after positioning of the Venetian blind.</p>

Fixed roller shutter / awning position	Same as configured value	<p>i This parameter is only visible, if the slat is to approach a fixed position at the beginning of shading.</p> <p>i This parameter is visible only in the "Venetian blind" operating mode.</p> <p>The fixed position of the roller shutter or awning at the beginning of shading can either be preset statically by a separate parameter or basically adjusted to the value prevailing at the time of shading activation, i.e. remain unchanged.</p>
	No change in current position	<p>At the beginning of shading, the configured roller shutter or awning position will be approached.</p> <p>At the beginning of shading, the current position of the roller shutter or awning will be maintained. Any movements in progress at the time of shading activation will be finished.</p>
Position of roller shutter / awning (0...100 %)	0... 50 ...100	<p>i This parameter is only visible when the roller shutter or awning should approach a fixed position value at the beginning of sun shading.</p> <p>i This parameter is visible only in the "Roller Shutter / Awning" operating mode.</p> <p>This parameter sets the fixed position of the roller shutter or awning to be approached at the beginning of shading.</p> <p>i This parameter is only visible, if the parameter "Fixed position of shutter / awning" is set to "as specified by parameter".</p> <p>i This parameter is only visible in the "Roller shutter/Awning" operating mode.</p>
Fixed position of venting louvre	Same as configured value	<p>The fixed venting louvre position at the beginning of shading can either be preset statically by a separate parameter or basically adjusted to the value prevailing at the time of shading activation, i.e. remain unchanged.</p> <p>At the beginning of shading, the configured venting louvre position will be approached.</p>
	No change in current position	<p>At the beginning of shading, the current position of the venting louvre will be maintained. Any movements in progress at the time of shading activation will be finished.</p> <p>i This parameter is only visible if the venting louvre is to approach a fixed position at the beginning of shading.</p>

Position of venting louvre (0...100 %)	0... 50 ...100	<p>i This parameter is visible only in the "Venting louvre" mode of operation.</p> <p>This parameter sets the fixed position of the venting louvre to be approached at the beginning of shading.</p>
Reference movement before each sun protection positioning operation ?	Yes No	<p>i This parameter is only visible, if the parameter "Fixed position of venting louvre" is set to "as specified by parameter".</p> <p>i This parameter is visible only in the "Venting louvre" operating mode.</p> <p>A forced reference movement of the drive is performed before sun protection positioning (setting "yes"). A reference movement is a positioning movement into the upper end position or into the completely open position. By means of a forced reference movement, drives connected to different outputs can be synchronised. If no synchronising movement is forced (setting "no"), the actuator performs a reference movement only once after return of the power supply.</p>
Offset with fixed and variable slat position	<p>no offset</p> <p>offset as parameterized</p> <p>offset as parameterized and via object</p>	<p>For 'manual' readjustment of the slat angle during a shading or sun position tracking operation, a slat offset can be preset. The offset corrects the preset slat angle in positive or in negative direction. The lighting conditions in a room can thus be individually adapted by persons present in the room.</p> <p>The offset correction is deactivated.</p> <p>The slat offset is statically preset by means of a fixed parameter value.</p> <p>The slat offset is preset by a fixed parameter value and can be dynamically adapted via a separate communication object.</p>
Offset slat position (-100..100 %)	-100... 0 ...100	<p>i This parameter is only visible, if the slat is to approach a fixed or a variable position at the beginning of shading.</p> <p>i This parameter is visible only in the 'Blind' mode of operation.</p> <p>This parameter is used for setting the slat offset. The value specified in this parameter is added at the beginning of shading to the current slat angle.</p> <p>i Even with offset correction, the 0...100% slat position limits cannot be overstepped.</p>

Store offset slat position in case of bus/mains voltage failure ?"

Yes

no

- i** It should be noted that the parameterized offset value can be overwritten by the object after reception of a dynamical value.
- i** This parameter is only visible, if the parameter "Offset with fixed and variable slat position" is set to "Offset as parameterized" or to "Offset as parameterized and via object".
- i** This parameter is visible only in the 'Blind' mode of operation.

If the offset is preset via the object, this parameter defines whether the received value is to be stored in the actuator's NV memory.

The value received via the object will be stored in case of bus or mains voltage failure in a non-volatile memory of the actuator. The originally parameterized offset value is definitely overwritten in the process.

The value received via the object will only be stored temporarily in volatile memory. Thus, the value received via the object replaces the parameterized value only until the actuator is re-initialized (return of bus or mains voltage, if both voltages were off beforehand). After the initialization, the offset value parameterized in the ETS will be used again.

- i** This parameter is only visible, if the parameter "Offset with fixed and variable slat position" is set to "offset as parameterized and via object".
- i** This parameter is visible only in the 'Blind' mode of operation.

☐Ax – End of sun protection

(x = number of output / In 12...48 VDC operation, outputs 1 + 2, 3 + 4, 5 + 6 and 7 + 8 combined into pairs.)

Time delay end of sunshine / shading Minutes (0...59)

0...59

The telegram received via the object "Sunshine / shading facade " for deactivation of shading (according to polarity) can be evaluated with a time delay.

Setting the minutes of the delay time.

Seconds (0...59)

0...30...59

Setting the delay time seconds.

Presetting: 30 seconds

- i** A time setting of "0" in the parameters deactivates the respective delay time. In this case, the state of shading is evaluated immediately.

Reaction at the end of
sunshine / shading

no reaction	This parameter defines the behaviour of the output at the end of shading – if applicable, after the end of the delay time.
raising / opening the louver	At the end of shading, the output quits the sun protection mode and the relays of the output show no reaction. Any travel movements still in progress at this instant will still be finished.
lowering / closing the louver	At the end of shading, the actuator lowers the curtain or closes the venting louver.
stop	At the end of shading, the actuator switches the relays of the output to the "stop" position. A travel movement, if any, will be interrupted.
tracking the position	<p>i The behaviour preset in this parameter will only be executed if no function with a higher priority (e.g. safety) is activated at the end of shading.</p> <p>i This parameter is only visible in the simple sun protection.</p> <p>At the end of shading, the output will be set to the state last adjusted before sun protection or to the state tracked and internally stored during sun protection. The position objects, the long-time object and the scene function are tracked.</p>

Reaction at the end of
sunshine / shading

no reaction	This parameter defines the behaviour of the output at the end of shading – if applicable, after the end of the delay time.
raising	At the end of shading, the relays of the output show no reaction. Any travel movements still in progress at this instant will still be finished.
lowering	At the end of shading, the actuator raises the curtain.
stop	At the end of shading, the actuator lowers the curtain.
internal scene recall	At the end of shading, the actuator switches the relays of the output to the "stop" position. A travel movement, if any, will be interrupted.
blind or slat position fixed	At the end of shading, an internal scene of the actuator is recalled.

Reaction at the end of sunshine / shading		<p>At the end of shading, the output moves to a parameterized fixed blind and slat position.</p> <ul style="list-style-type: none"> i This parameter is only visible in the enlarged sun protection. i This parameter is visible only in the 'Blind' mode of operation. i This parameter does not define the behaviour of the output at the end of automatic operation (cf. parameter "Reaction at the end of automatic operation")! <p>This parameter defines the behaviour of the output at the end of shading – if applicable, after the end of the delay time.</p>
	no reaction	<p>At the end of shading, the relays of the output show no reaction. Any travel movements still in progress at this instant will still be finished.</p>
	raising	<p>At the end of shading, the actuator raises the curtain.</p>
	lowering	<p>At the end of shading, the actuator lowers the curtain.</p>
	stop	<p>At the end of shading, the actuator switches the relays of the output to the "stop" position. A travel movement, if any, will be interrupted.</p>
	internal scene recall	<p>At the end of shading, an internal scene of the actuator is recalled.</p>
	shutter / awning position fixed	<p>At the end of shading, the output moves to a parameterized fixed shutter / awning position.</p> <ul style="list-style-type: none"> i This parameter is only visible in the enlarged sun protection. i This parameter is visible only in the "Shutter / awning" mode of operation. i This parameter does not define the behaviour of the output at the end of automatic operation (cf. parameter "Reaction at the end of automatic operation")! <p>This parameter defines the behaviour of the output at the end of shading – if applicable, after the end of the delay time.</p>
Reaction at the end of sunshine / shading		<p>At the end of shading, the relays of the output show no reaction. Any travel movements still in progress at this instant will still be finished.</p>
	no reaction	<p>At the end of shading, the relays of the output show no reaction. Any travel movements still in progress at this instant will still be finished.</p>
	opening the louver	<p>At the end of shading, the actuator opens the venting louver.</p>

	closing the louver	At the end of shading, the actuator closes the venting louver.
	stop	At the end of shading, the actuator switches the relays of the output to the "stop" position. A travel movement, if any, will be interrupted.
	internal scene recall	At the end of shading, an internal scene of the actuator is recalled.
	venting louver position fixed	At the end of shading, the output moves to a parameterized fixed venting louver position. <ul style="list-style-type: none"> i This parameter is only visible in the enlarged sun protection. i This parameter is visible only in the "Venting louver" mode of operation. i This parameter does not define the behaviour of the output at the end of automatic operation (cf. parameter "Reaction at the end of automatic operation")!
Scene number (1...8)	1...8	This parameter defines the number of the internal scene which is recalled at the end of shading. <ul style="list-style-type: none"> i This parameter is only visible, if the parameter "Reaction at the end of sunshine / shading" is set to "internal scene recall".
Fixed position of blind		The fixed blind position at the end of shading can either be preset statically by a separate parameter or basically remain at the value set or tracked by the shading operation. as specified by parameter At the end of shading, the parameterized blind position will be approached.
	no change in current position	At the end of shading, the current position of the blind will be maintained. In this case, the output behaves as if only the slat were positioned as a result of the end of shading. <ul style="list-style-type: none"> i This parameter is only visible, if the blind is to approach a fixed position at the end of shading. i This parameter is visible only in the 'Blind' mode of operation.
Position of blind (0...100 %)	0... 50 ...100	This parameter sets the fixed position of the blind to be approached at the end of shading. <ul style="list-style-type: none"> i This parameter is only visible, if the parameter "Fixed position of blind" is set to "as specified by parameter".

Fixed position of slat (0...100 %)	0... 50 ...100	<p>i This parameter is visible only in the 'Blind' mode of operation.</p> <p>This parameter sets the fixed position of the slat to be approached at the end of shading and, as the case may be, after positioning of the blind.</p>
Fixed position of shutter / awning	as specified by parameter	<p>i This parameter is only visible, if the slat is to approach a fixed position at the beginning of shading.</p> <p>i This parameter is visible only in the 'Blind' mode of operation.</p> <p>The fixed position of the shutter or awning at the end of shading can either be preset statically by a separate parameter or basically adjusted to the value prevailing at the time of shading activation, i.e. remain unchanged.</p>
	no change in current position	<p>At the end of shading, the parameterized shutter / awning position will be approached.</p> <p>At the end of shading, the current position of the shutter or awning will be maintained. Any travel movements in progress at the time of shading activation will be finished.</p>
Position of shutter / awning (0...100 %)	0... 50 ...100	<p>i This parameter is only visible, if the shutter or awning is to approach a fixed position at the end of shading.</p> <p>i This parameter is visible only in the "Shutter / awning" mode of operation.</p> <p>This parameter sets the fixed position of the shutter or awning to be approached at the end of shading.</p>
Fixed position of venting louver	as specified by parameter	<p>i This parameter is only visible, if the parameter "Fixed position of shutter / awning" is set to "as specified by parameter".</p> <p>i This parameter is visible only in the "Shutter / awning" mode of operation.</p> <p>The fixed venting louver position at the end of shading can either be preset statically by a separate parameter or basically adjusted to the value prevailing at the time of shading activation, i.e. remain unchanged.</p>
	no change in current position	<p>At the end of shading, the parameterized venting louver position will be approached.</p> <p>At the end of shading, the current position of the venting louver will be maintained. Any travel movements in progress at the time of shading activation will be finished.</p>

<p>Position of venting louver (0...100 %)</p>	<p>0...50...100</p>	<p>i This parameter is only visible if the venting louver is to approach a fixed position at the end of shading.</p> <p>i This parameter is visible only in the "Venting louver" mode of operation.</p> <p>This parameter sets the fixed position of the venting louver to be approached at the end of shading.</p> <p>i This parameter is only visible, if the parameter "Fixed position of venting louver" is set to "as specified by parameter".</p> <p>i This parameter is visible only in the "Venting louver" mode of operation.</p>
<p><input type="checkbox"/> Ax – Automatic heating/cooling (x = number of output / In 12...48 VDC operation, outputs 1 + 2, 3 + 4, 5 + 6 and 7 + 8 combined into pairs.)</p> <p>Automatic heating/cooling</p>	<p>disabled</p> <p>enabled</p>	<p>This parameter can be used to activate the automatic heating/cooling function. The automatic heating/cooling function adds a presence detection function to the enlarged sun protection mode. If a person is present, the enlarged sun protection is executed as described. If nobody is present, however, the blinds, shutters, awnings or venting louvers can be operated in such a way that these devices support the heating or cooling function of the building. When the function is enabled, the other parameters and objects are visible.</p> <p>i The automatic heating/cooling function can only be activated in the enlarged sun protection mode.</p> <p>i Moreover, the automatic heating/cooling function is only active when the automatic mode of the enlarged sun protection function is activated.</p>
<p>Object polarity "Heating/cooling switchover"</p>	<p>Cooling = 0; Heating = 1</p> <p>Cooling = 1; Heating = 0</p>	<p>This parameter defines the polarity of the object for heating/cooling switchover. This object is linked, for instance, with room temperature controllers or outside thermometers.</p> <p>i The heating/cooling switchover is initialised after the return of the supply voltage of the actuator according to the object value "0" and the set polarity.</p> <p>i This parameter is visible only if automatic heating/cooling is enabled.</p>
<p>Object polarity "Heating/cooling presence"</p>	<p>No presence = 0; Presence = 1</p> <p>No presence = 1; Presence = 0</p>	<p>This parameter defines the polarity of the object for presence control in case of automatic heating/cooling. This object is linked, for example, with presence detectors.</p>

Time delay at the beginning of presence Minutes (0...59)	0...59	<p>i The heating/cooling presence control is initialised after the return of the supply voltage of the actuator according to the object value "0" and the set polarity.</p> <p>i This parameter is visible only if automatic heating/cooling is enabled.</p>
Seconds (0...59)	0... 30 ...59	<p>The telegram received via the object "Heating/cooling presence" for activation of the presence function (in acc. with polarity) can be evaluated with a time delay.</p> <p>Setting the minutes of the delay time.</p> <p>Setting the delay time seconds.</p> <p><i>Presetting: 30 seconds</i></p>
Time delay at the end of presence Minutes (0...59)	0...59	<p>i A time setting of "0" in the parameters deactivates the respective delay time. In this case, the state of the presence object is evaluated immediately.</p> <p>i These parameters are visible only if automatic heating/cooling is enabled.</p>
Seconds (0...59)	0... 30 ...59	<p>The telegram received via the object "Heating/cooling presence" for deactivation of the presence function (in acc. with polarity) can be evaluated with a time delay.</p> <p>Setting the minutes of the delay time.</p> <p>Setting the delay time seconds.</p> <p><i>Presetting: 30 seconds</i></p>
Reaction at sunshine / shading	no reaction	<p>i A time setting of "0" in the parameters deactivates the respective delay time. In this case, the state of the presence object is evaluated immediately.</p> <p>i These parameters are visible only if automatic heating/cooling is enabled.</p> <p>This parameter defines the behaviour of the output at the end / at the beginning of sunshine / shading with heating / cooling – if applicable, after the end of the delay time.</p> <p>The relays of the output show no reaction. Any travel movements still in</p>
Beginning with cooling *		
End with cooling *		
Beginning with heating *		
End with heating *		

		progress at this instant will still be finished.
	raising	The actuator raises the curtain.
	lowering	The actuator lowers the curtain.
	internal scene recall	An internal scene of the actuator is recalled.
	blind or slat position fixed	At the end of shading, the output moves to a parameterized fixed blind and slat position.
		<p>i This parameter is visible only if automatic heating/cooling is enabled.</p> <p>i This parameter is visible only in the 'Blind' mode of operation.</p> <p>i *: The parameter settings for heating or cooling or beginning or end must be parameterized separately. The setting options - also for the follow-up parameters - are identical in all cases.</p>
Reaction at sunshine / shading		This parameter defines the behaviour of the output at the end / at the beginning of sunshine / shading with heating / cooling – if applicable, after the end of the delay time.
Beginning with cooling *		
End with cooling *		
Beginning with heating *		
End with heating *		
	no reaction	The relays of the output show no reaction. Any travel movements still in progress at this instant will still be finished.
	raising	The actuator raises the curtain.
	lowering	The actuator lowers the curtain.
	internal scene recall	An internal scene of the actuator is recalled.
	fixed shutter / awning position	The output moves to a parameterized fixed shutter or awning position.
		<p>i This parameter is visible only if automatic heating/cooling is enabled.</p> <p>i This parameter is visible only in the "Shutter / awning" mode of operation.</p>

Reaction at sunshine / shading

Beginning with cooling *

End with cooling *

Beginning with heating *

End with heating *

i *: The parameter settings for heating or cooling or beginning or end must be parameterized separately. The setting options - also for the follow-up parameters - are identical in all cases.

This parameter defines the behaviour of the output at the end / at the beginning of sunshine / shading with heating / cooling – if applicable, after the end of the delay time.

no reaction

The relays of the output show no reaction. Any travel movements still in progress at this instant will still be finished.

opening the louver

The actuator opens the venting louver.

closing the louver

The actuator closes the venting louver.

internal scene recall

An internal scene of the actuator is recalled.

venting louver position fixed

At the end of shading, the output moves to a parameterized fixed venting louver position.

i This parameter is visible only if automatic heating/cooling is enabled.

i This parameter is visible only in the "Venting louver" mode of operation.

i *: The parameter settings for heating or cooling or beginning or end must be parameterized separately. The setting options - also for the follow-up parameters - are identical in all cases.

Scene number (1...8)

1...8

This parameter defines the number of the internal scene which is recalled.

i This parameter is only visible, if the parameter "Reaction in case of sunshine / shading" of the automatic heating/cooling function is set to "internal scene recall".

Fixed position of blind

The fixed blind position in case of automatic heating/cooling can either be preset statically by a separate parameter or basically remain at the current value.

as specified by parameter

The parameterized position of the blind will be approached.

	no change in current position	The current position of the blind will be maintained. In this case, the output behaves as if only the slat were positioned.
		<ul style="list-style-type: none"> i This parameter is only visible, if the blind is to approach a fixed position in case of automatic heating/cooling. i This parameter is visible only in the 'Blind' mode of operation.
Position of blind (0...100 %)	0... 50 ...100	<p>This parameter sets the fixed position of the blind to be approached in case of automatic heating/cooling.</p> <ul style="list-style-type: none"> i This parameter is only visible, if the parameter "Fixed position of blind" is set to "as specified by parameter". i This parameter is visible only in the 'Blind' mode of operation.
Fixed position of slat (0...100 %)	0... 50 ...100	<p>This parameter sets the fixed position of the slat to be approached in case of automatic heating/cooling and, as the case may be, after positioning of the blind.</p> <ul style="list-style-type: none"> i This parameter is only visible, if the slat is to approach a fixed position with automatic heating/cooling. i This parameter is visible only in the 'Blind' mode of operation.
Fixed position of shutter / awning		<p>The fixed shutter/awning position in case of automatic heating/cooling can either be preset statically by a separate parameter or basically remain at the current value.</p> <p>as specified by parameter The parameterized shutter / awning position will be approached.</p>
	no change in current position	<p>The current shutter / awning position will be maintained.</p> <ul style="list-style-type: none"> i This parameter is only visible, if the shutter or awning is to approach a fixed position in case of automatic heating/cooling. i This parameter is visible only in the "Shutter / awning" mode of operation.
Position of shutter / awning (0...100 %)	0... 50 ...100	<p>This parameter sets the fixed position of the blind to be approached with automatic heating/cooling.</p> <ul style="list-style-type: none"> i This parameter is only visible, if the parameter "Fixed position of shutter / awning" is set to "as specified by parameter".

Fixed position of venting louver		<p>i This parameter is visible only in the "Shutter / awning" mode of operation.</p> <p>The fixed venting louver position in case of automatic heating/cooling can either be preset statically by a separate parameter or basically remain at the current value.</p>
	as specified by parameter	The parameterized venting louver position will be approached.
	no change in current position	The current position of the venting louver will be maintained.
		<p>i This parameter is only visible, if the venting louver is to approach a fixed position in case of automatic heating/cooling.</p> <p>i This parameter is visible only in the "Venting louver" mode of operation.</p>
Position of venting louver (0...100 %)	0... 50 ...100	<p>This parameter sets the fixed position of the venting louver to be approached in case of automatic heating/cooling.</p> <p>i This parameter is only visible, if the parameter "Fixed position of venting louver" is set to "as specified by parameter".</p> <p>i This parameter is visible only in the "Venting louver" mode of operation.</p>
<p>□-Ax – Scenes (x = number of output / In 12...48 VDC operation, outputs 1 + 2, 3 + 4, 5 + 6 and 7 + 8 combined into pairs.)</p>		
Delay scene recall ?	Yes No	<p>A scene is recalled via the scene extension object. If needed, the scene recall on the actuator can be made with a delay after reception of a recall telegram (setting: "Yes"). The recall is alternatively made immediately on reception of the telegram (setting: "No").</p> <p>i A recall delay has no influence on the storage of scene values.</p>
Delay time Minutes (0...59)	0...59	<p>This parameter is used for programming the duration of the delay time for a scene recall.</p> <p>Set the delay time minutes.</p>
Seconds (0...59)	0... 10 ...59	<p>Sets the delay time seconds.</p> <p><i>Presetting: 10 seconds</i></p> <p>i The delay time parameters are only visible, if the parameter "Delay scene recall ?" is set to "yes".</p>
Overwrite values stored in the device during an ETS download ?	Yes no	<p>During storage of a scene, the scene values (current states of the outputs concerned) are stored internally in the device. To prevent the stored values</p>

<p>Scene X can be activated by scene number (scene number "0" = scene deactivated)</p> <p><i>X = depending on the scene (1...8)</i></p>	<p>0...1*...64</p> <p><i>*: The predefined scene number is dependent on the scene (1...8).</i></p>	<p>from being replaced during an ETS programming operation by the originally programmed scene states, the actuator can inhibit overwriting of the scene values (setting: "No"). As an alternative, the original values can be reloaded into the device during each ETS programming operation (setting: "Yes").</p> <p>The actuator distinguishes between up to 8 different scenes which are recalled via the scene extension object or stored. The datapoint type of the extension object, however, permits addressing a maximum of 64 scenes. This parameter defines the scene number (1...64) which is used to address the internal scene (1...8). A setting of "0" deactivates the corresponding scene.</p>
<p>Position of blind for scene X</p> <p><i>X = depending on the scene (1...8)</i></p>	<p>0*...100</p> <p><i>*: The predefined position value is dependent on the scene (1...8).</i></p>	<p>This parameter is used for parameterizing the blind position which is executed when the scene is recalled.</p> <p>i This parameter is visible only in the 'Blind' mode of operation.</p>
<p>Position of slat for scene X</p> <p><i>X = depending on the scene (1...8)</i></p>	<p>0*...100</p> <p><i>*: The predefined position value is dependent on the scene (1...8).</i></p>	<p>This parameter is used for parameterizing the slat position which is executed when the scene is recalled.</p> <p>i This parameter is visible only in the 'Blind' mode of operation.</p>
<p>Position of shutter/awning for scene X</p> <p><i>X = depending on the scene (1...8)</i></p>	<p>0*...100</p> <p><i>*: The predefined position value is dependent on the scene (1...8).</i></p>	<p>This parameter is used for parameterizing the shutter or awning position which is executed when the scene is recalled.</p> <p>i This parameter is visible only in the 'Shutter/awning' mode of operation.</p>
<p>Position of venting louver for scene X</p> <p><i>X = depending on the scene (1...8)</i></p>	<p>0*...100</p> <p><i>*: The predefined position value is dependent on the scene (1...8).</i></p>	<p>This parameter is used for parameterizing the venting louver position which is executed when the scene is recalled.</p> <p>i This parameter is visible only in the "Venting louver" mode of operation.</p>
<p>Storage function for scene X</p> <p><i>X = depending on the scene (1...8)</i></p>	<p>Yes</p> <p>No</p>	<p>Setting "yes" enables the storage function of the scene. If the function is enabled, the current position (0...100 %) can be stored internally via the extension object on reception of a storage telegram. If "no" is selected, the storage telegrams are rejected.</p>
<p><input type="checkbox"/> Ax – Forced position (x = number of output / In 12...48 VDC operation, outputs 1 + 2, 3 + 4, 5 + 6 and 7 + 8 combined into pairs.)</p>		
<p>Behaviour at the end of the forced position function</p>		<p>The behaviour of the output at the beginning of a forced position function is directly determined by the forced position telegram. The behaviour of the</p>

Behaviour after bus voltage return

	output at the end of the forced position function can be configured.
Tracking the position	At the end of the forced position state, the output will be set to the position last existing before the forced position function or to the one tracked internally while the forced position function was active.
No change	At the end of forced position state, the position last adjusted will not be changed. Thereafter, the output is again enabled.
	The forced position communication object can be initialised after <u>bus</u> voltage return.
No forced position active	The forced position is deactivated after bus voltage return.
Forced position on, raising / opening the louvre	After bus voltage return, the forced position is activated and the blind raised or the venting louvre opened.
Forced position on, lowering / closing the louvre	After bus voltage return, the forced position is activated and the blind lowered or the venting louvre closed.
State of forced position before bus/mains voltage failure	After bus voltage return, the forced-position state last selected and internally stored <u>before</u> bus or mains voltage failure will be tracked. An ETS programming operation deletes the stored state (reaction in that case same as with "no forced position active").
	<p>i This parameter is evaluated even after an ETS download of the application or of parameters.</p> <p>i The forced-position parameters are only visible, if the parameter "Forced-position function" under "Ax enabled functions" is set to "enabled".</p>

5 Appendix

5.1 Index

A	
Activate sun protection automatic.....	70
Activating fabric-stretching.....	96
as-delivered state.....	97
Assigning safety alarms.....	59
Automatic heating/cooling.....	84
B	
Behaviour after ETS programming.....	40
Behaviour bus voltage failure.....	41
Behaviour bus voltage return.....	42
Behaviour mains voltage return.....	42
Bus voltage failure/return.....	40
C	
Calculating the slat position.....	48
Central function.....	33
Change-over time.....	47-48
Channel definition.....	33
Configuring slat offset of sun protection ..	77
D	
Delay.....	33
Determining and configuring long-time operation ..	43-44
Determining and configuring short-time operation ..	43
Determining and configuring travelling time ..	44
E	
Enabling automatic heating/cooling.....	87
Enabling the forced position function.....	94
Enabling the manual control mode.....	34
Enabling the safety functions.....	38
ETS project design and start-up.....	23
ETS search paths.....	19
F	
Fabric-stretching.....	95
Forced position.....	93
G	
General.....	98
M	
Mains voltage failure/return.....	40
Manual control.....	34
Manual control - disabling bus control...	37
Manual control behaviour at beginning..	35 and end
Manual control disabling.....	36
Manual control on the device.....	15
Manual control status message.....	36
Measuring the travelling times without end position detection ..	45
O	
operating mode.....	40
P	
Parameter "Safety general" ..	99
Parameter "Safety times".....	100
Parameter automatic heating/cooling (channel-oriented) ..	129
Parameter enabled functions channel-oriented ..	108
Parameter feedbacks channel-oriented ..	109
Parameter forced position channel-oriented ..	135
Parameter General channel-oriented...	102
Parameter Manual control.....	101
Parameter safety functions channel-oriented ..	113
Parameter Scene function channel-oriented ..	134
Parameter sun protection function - General information ..	115
Parameter sun protection function beginning channel-oriented ..	118
Parameter sun protection function end channel-oriented ..	124
Parameter times channel-oriented.....	106
Position calculation of slat.....	50
Position feedback.....	54
Presetting behaviour at the end of forced position ..	94
Presetting change-over time.....	48
Presetting delayed scene recall.....	91
Presetting disabling function for direct operation ..	72
Presetting disabling function of sun protection automatic ..	71
Presetting download behaviour of scene function ..	91
Presetting fabric-stretching.....	96
Presetting 'invalid position' feedback.....	57

Presetting polarity heating/cooling .. 88 automatic	Sun protection function..... 61
Presetting polarity sun protection..... 70-71	Sun protection slat offset..... 76
Presetting position feedback..... 54	T
Presetting position feedback for slats.... 55	Travel movement feedback..... 56
Presetting priority of sun protection..... 68	Travelling time extension..... 47
Presetting priority sun protection .. 69 automatic	
Presetting reaction at the beginning of .. 74 sun protection	
Presetting reaction at the end of sun .. 72 protection automatic	
Presetting reaction at the end of .. 78-79 sunshine	
Presetting reaction heating/cooling .. 89 automatic	
Presetting reference travel for sun .. 75 protection	
Presetting scene numbers..... 91	
Presetting scene position..... 92	
Presetting the behaviour at the .. 59 beginning of safety alarms	
Presetting the behaviour at the end of .. 60 safety alarms	
Presetting the behaviour of the forced .. 95 position function after bus voltage return	
Presetting the position..... 53	
Presetting the slat moving time..... 47	
Presetting the storage behaviour for .. 92 the scene function	
Presetting the travel movement .. 57 feedback	
Presetting the travelling time .. 48 extension	
Presetting time delay heating/cooling .. 88 automatic	
Presetting time delay sun protection..... 73	
Presetting type of sun protection..... 67	
R	
Reference travel..... 51	
S	
Safe-state mode..... 23	
Safety function..... 58	
Safety functions cyclical monitoring..... 39	
Safety functions global..... 37	
Safety functions presetting priorities..... 38	
Scene function..... 90	
Slat moving time..... 46	
Status LED..... 6	
Storing the travelling times with end .. 45 position detection	
Sun protection application examples..... 80	

Gira
Giersiepen GmbH & Co. KG
Elektro-Installations-
Systeme

Industriegebiet Mermbach
Dahlienstraße
42477 Radevormwald

Postfach 12 20
42461 Radevormwald

Deutschland

Tel +49(0)21 95 - 602-0
Fax +49(0)21 95 - 602-399

www.gira.de
info@gira.de