



Product name: **Weather station**
Design: REG (series mounting)
Article no.: **1010 00**
ETS search path: Gira Giersiepen / Input/Analog input/Weather station
Gira Giersiepen / Phys. sensors/Weather station/Weather station

Functional description:

The weather station serves to collect and forward weather data and events. A digital combination sensor, ordering no. 1025 00 (to measure the wind intensity, brightness and twilight as well as rain; with DCF77 receiver), and up to four analog measuring sensors can be connected to the weather station. An optional analog input module allows for an extension of the range of analog measuring sensors to be connected by another four.

The following measuring sensors, for which preset parameters are available in the device software, can be connected to the analog inputs:

Brightness	Ordering no. 0576 00
Twilight	Ordering no. 0572 00
Temperature	Ordering no. 0577 00
Wind	Ordering no. 0580 00
Rain	Ordering no. 0579 00

Alternatively, other measuring sensors supplying voltage or current signals (0 ... 1 VDC, 0 ... 10 VDC, 0 ... 20 mADC, 4 ... 20 mADC) can be used, too. For sensors which supply 4...20 mA signals, the device software parameters offer the option to select wire breakage or open-circuit monitoring.

The values measured are translated by the weather station into value telegrams (DPT 9.0xx, 2-byte or DPT 5.001, 1-byte type). Thus, other bus devices (e. g. visualization software, info display, ...) can display such measured values, generate messages or control weather-dependent processes.

For each measured value, two adjustable limits are available. Once a measured value exceeds or falls below such limits, the weather station can issue corresponding messages. At the same time, such limits can be gated. Cascading several weather stations can even help to implement complex functions. The limit values can optionally be adjusted with the help of the parameterization software or via telegrams from other bus users. 1-byte telegrams, 2-byte telegrams can be used to preset via external bus devices. In addition, a Teach-In function allows to save the current measured value as the new limit. The Teach-In function is not available for rain and wind sensors.

The weather station needs an operating voltage supply of 24 VAC. The latter can, for example, be provided by a power supply module ordering no. 1024 00. At the same time, such power supply module can also heat wind sensors.

Terminals +Us and GND serve to supply external analog sensors with 24 VDC (100 mA max. in total). In the event of a short-circuit between +US and GND, the voltage will be switched off.

instabus KNX/EIB System

Sensor



Illustration:

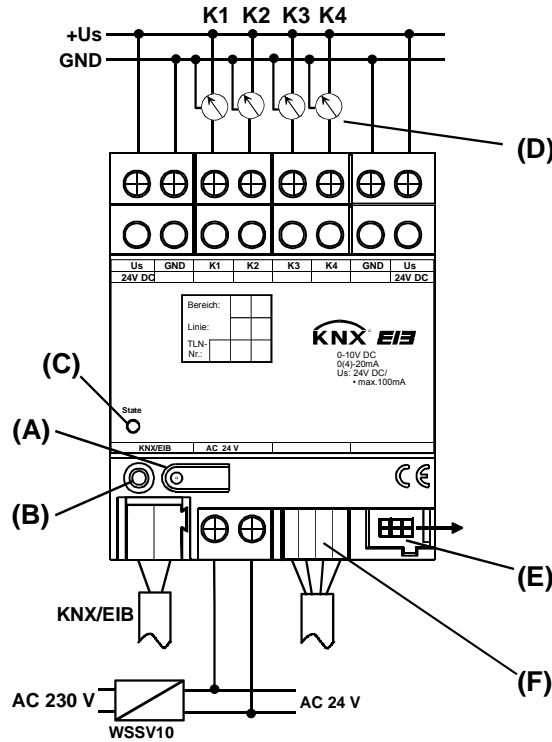

Dimensions:

Width: 72 mm, 4 TE
 Height: 90 mm
 Depth: 58 mm

Controls:

- A: Programming key
- B: Programming LED
- C: Status LED, three-colour (red, orange, green)
- D: Measuring sensors
- E: Module connector, 6-pole
- F: Combination sensor connector, 4-pole

Status LED functions:

LED OFF	No voltage supply.
LED orange/ON	Module scan by weather station.
LED red/slowly blinking	Error: US short-circuited.
LED red/quickly blinking	Error: no project, parameterization error
LED green/slowly blinking	configuration OK.
LED green/quickly blinking	Parameter download into module.
LED green/ON	Initialization complete, everything OK.
Slowly blinking	approx. 1 Hz
Quickly blinking	approx. 2 Hz



Technical data:

instabus KNX/EIB power supply

Voltage:	21 ... 32 V DC
Power consumption:	150 mW typical
Connection:	Bus connecting terminal (KNX type 5.1)

External power supply:

Voltage:	24 V AC \pm 10 %
Current consumption:	250 mA max.
Connection:	Screw terminals: 0.5 mm ² to 4 mm ² , single-wire Screw terminals: 0.34 mm ² to 4 mm ² , fine-wire (without ferrule) Screw terminals: 0.14 mm ² to 2.5 mm ² , fine-wire (incl. ferrule)

Response to voltage failure

Bus voltage only:	No communication with KNX/EIB.
Operating voltage only:	No communication with KNX/EIB, no feeding of the measuring sensors.
Bus and mains/operating voltage	No communication with KNX/EIB, no feeding of the measuring sensors.

Response to recovery

Bus voltage only:	No communication with KNX/EIB, no feeding of the measuring sensors.
Operating voltage only:	No communication with KNX/EIB.
Bus and mains/operating voltage	Communication with KNX/EIB according to initialization parameters.

Protective system:

IP 20

Mark of conformity:

KNX / EIB

Ambient temperature:

-5 °C to +45 °C

Storage/transport temperature:

-25 °C to +70 °C,

storage at temperatures above +45 °C will shorten equipment life

Max. housing temperature

T_c = 75 °C

Relative humidity:

93 % RH max., no condensation

Fitting position:

Any

Minimum distances:

None

Type of fixing:

Snapping onto 35 x 7.5 mm top hat rail, data rail not required.

Module connection

Number: 2

Connection: 6-pole system connector for analog input module

4-pole system connector for combination sensor

Analog inputs

Number: 4

Signal voltage/current: 0...1 V DC, 0...10 V DC, 0...20 mA DC or 4...20 mA DC,

depending on parameterization

Input resistance

Voltage measurement: approx. 18 k Ω Current measurement: approx. 100 Ω

Connection:

Screw terminals: 0.5 mm² to 4 mm², single-wireScrew terminals: 0.34 mm² to 4 mm², fine-wire (without ferrule)Screw terminals: 0.14 mm² to 2.5 mm², fine-wire (incl. ferrule)

Measuring sensor power supply

outputs

Number: 2

Rated voltage: 24 V DC \pm 10 %

Rated current: 100 mA DC (total)

Connection:

Screw terminals: 0.5 mm² to 4 mm², single-wireScrew terminals: 0.34 mm² to 4 mm², fine-wire (without ferrule)Screw terminals: 0.14 mm² to 2.5 mm², fine-wire (incl. ferrule)



Wiring diagram and terminal assignment:

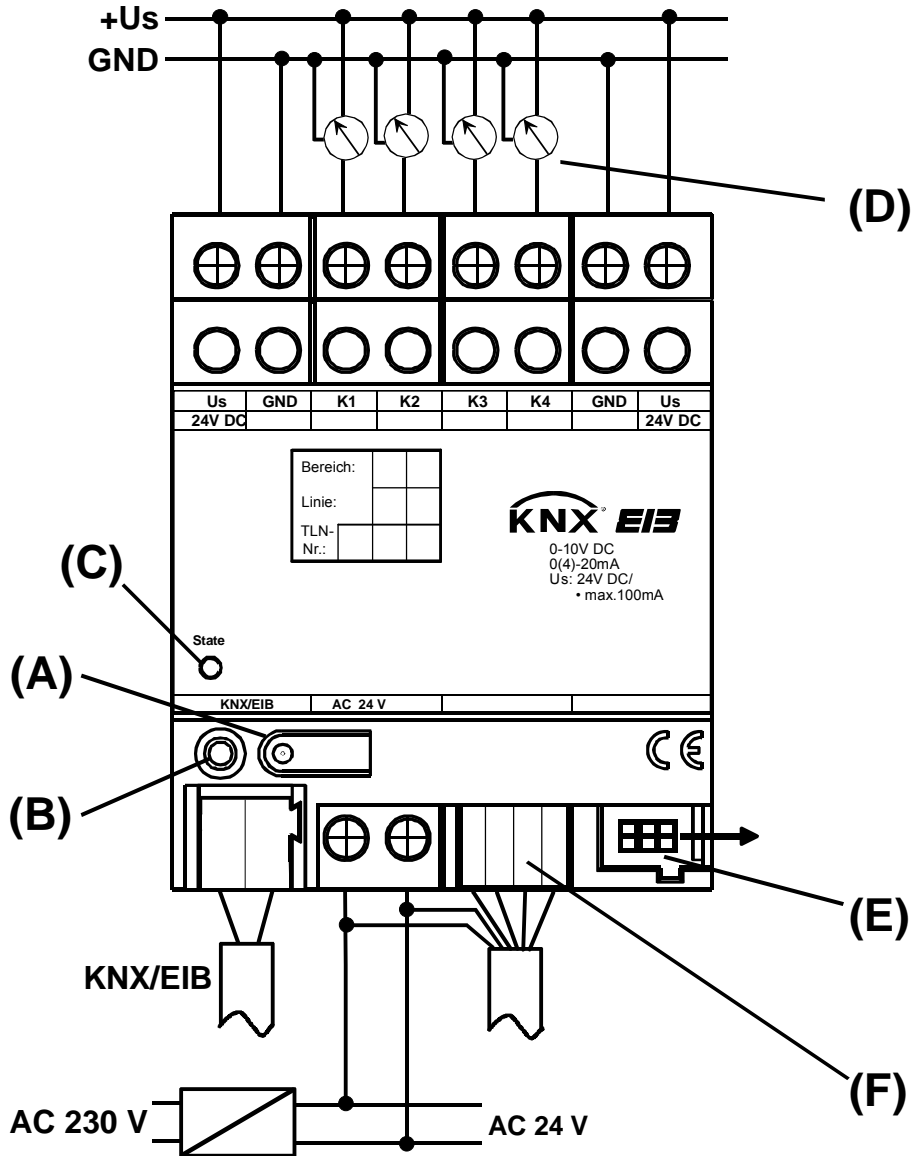

Connection:

+Us: Power supply of external sensors
 GND: reference potential for +Us and inputs
 K1..K4: measured-value inputs

A: Programming key
 B: Programming LED
 C: Status LED, three-colour (red, orange, green)
 D: Measuring sensors
 E: Reserved for future applications.
 F: Combination sensor connection (4-pole)

EIB: KNX/EIB connecting terminal
 24V AC: External supply voltage



Combination sensor alignment and installation

Internal sensor position:

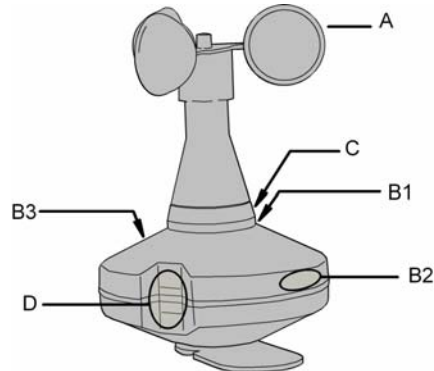

- A: Wind wheel
- B1 ... B3 Brightness sensors West, East, South
- C: Twilight sensor
- D: Precipitation sensor

If the combination sensor is connected to a weather station with the current application software (Weather station B00602) and the current firmware, the login will take place automatically. When using the older application software (Weather station B00601) the combination sensor will login by shortly actuating the magnetic contact.

Combination sensor orientation

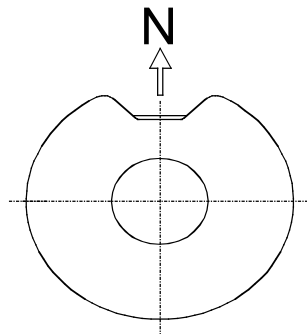

To reliably detect the beginning of dawn/dusk and to correctly determine the solar radiation during the course of the day align the combination sensor exactly to the North when mounting it to the pole. If automatic shading is used, the correct alignment towards the North is necessary.

instabus KNX/EIB System

Sensor

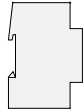

DCF receiver alignment

An optimum reception of the DCF77 time signal requires the integrated antenna to be aligned. The antenna can be accessed with a screwdriver on the rear side of the combination sensor. The antenna can be rotated by approx. 90°.

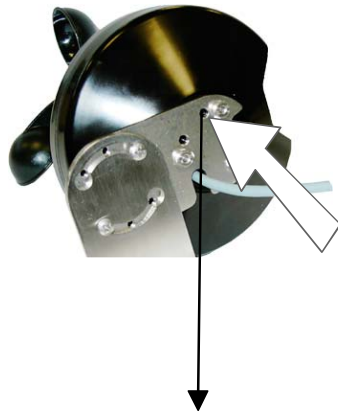

Alignment without electrical connection

Align the antenna in such a way that the slot of the adjustment screw lies 90 degrees to the direction of Frankfurt/Main (D)

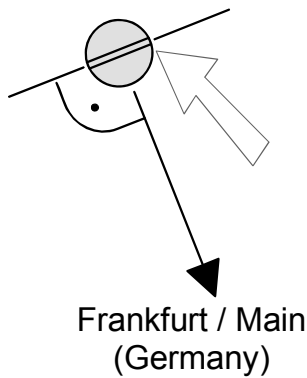

Frankfurt / Main
(Germany)

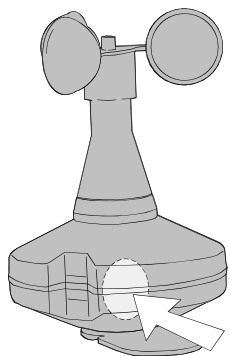

Alignment with electrical connection

Hold the enclosed magnet to the integrated Reed contact so that you can hear 5 short beeps. Keep the magnet in position.

The combination sensor indicates the reception of the time signal with short beeps (one beep every second; pausing each minute).

Note: The quality of the time signal does not depend on the length of the beeps.

Align the antenna.

In case the time signal is fully received, the antenna is correctly aligned.

In case the signal is not or only partly received, choose a new installation site.

Remove the magnet. The combination sensor will indicate the removal with a 5 sec. long beep

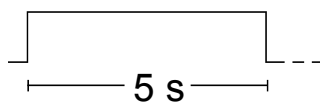
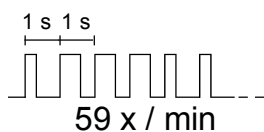
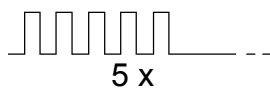



Remarks on the Hardware

Please observe the following basic rules when installing the weather station:

- Any sensors connected can be power-supplied via terminals +US and GND (refer to the wiring diagram). These terminals are provided in duplicate and are internally connected with each other. The total current consumption of all sensors power-supplied this way must not exceed 100 mA.
- In the event of a short-circuit between +US and GND, the voltage will be switched off. After the elimination of the fault, the voltage will reappear automatically.
- Sensors connected can also be power-supplied externally (SELV), e. g. if their current consumption exceeds 100 mA. In this case, such sensors must be connected between terminals K1...K4 and GND.
- The pillar terminal block for the connection of the combination sensor must be plugged on before the mains voltage is switched on and during operation to prevent the digital input from unintentional contact with live wiring. The device as well as any sensors or analog input modules connected can be destroyed thereby.
- The +US und GND terminals must not be connected with the corresponding inputs of a different device. The power supply of any sensors used through an analog input module connected is not permitted (hazard of destruction).

When mounting and installing the combination sensor, please observe the following things:

- The sensor comes with a stainless steel bracket for installation on a tubular pole (35 ...50 mm dia.). Depending on the wind intensity, very high forces can occur on such pole.
- If external lightning protection is provided the pole must not be higher than the lightning rod.
- The combination sensor should not be affected from any direction by obstacles or shadows. For this reason, a sufficient distance from walls or roof superstructures such as exhaust blowers should be kept.
- To enable the brightness and the twilight sensors to clearly detect the solar altitude align the combination sensor so that its precipitation window faces north.
- Removing or adding modules without adapting their configuration and subsequent downloading into the weather station is not allowed as this will result in system malfunctioning.
- After the first start, the weather station will run a module scan (status LED: "orange/ON"). Since a new device does not include any configuration by default the status LED will then change to "red/quickly blinking".
- The combination sensor connected indicates its readiness for operation by two short tones which will recur every 5 s.
- A defective combination sensor can be replaced in operation by another one of the same type. In such case, the new combination sensor must be logged in once again and aligned. After logging in the new combination sensor, the weather station will reset after about 25 s. This will re-initialize all inputs and outputs of the weather station and of the modules connected and reset them to their original state.

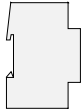

Software Description

ETS-search path:

ETS-Symbol:

Gira Giersiepen / Input/Analog input/Weather station

Gira Giersiepen / Phys. sensors/Weather station/Weather station

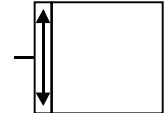

Applicationen:

Summarized description:

Name:

Date:

Page:

Version:

Weather station with digital combination sensor and analog input module options

Weather station B00602

07.06

9

10109110

The weather station, with the application described in this documentation, is configured in the ETS using a plug-in (embedded software) and then commissioned. The plug-in is opened automatically when the parameter view of the weather station is opened in the ETS.

The plug-in also makes it possible to update the firmware of existing weather stations, for example in existing ETS projects, through recommissioning. The plug-in has a version label, making the device firmware therein visible. The plug-in version can be viewed in the menu under "Help - About".

More recent plug-in versions - visible through the higher version number - replace previous published variants.

The functions described in this documentation are available in the plug-in from version "2.5". Devices commissioned with this version or a more recent version will possess the scope of functions in the documentation.

The following functions are not available in plug-in versions before < 2.5...

- Communication object "Measured value, brightness and twilight [Max. brightness and twilight]" and the connected enabling and transmission property parameters in the "Combination sensor" parameter branch",
- "Rain detection" parameter in the "Precipitation" parameter branch of the combination sensor.

During device programming, the plug-in automatically detects whether a firmware update is required or not. Such an update is required if a plug-in is used during configuration which is a later version than the plug-in used to configure and commission the device.



Application: Weather station B00602

Function Scope

- The weather station can be combined with a digital combination sensor to detect brightness (in triple form), twilight, wind speed and precipitation as well as for DCF77 reception.
- The connection to the combination sensor and the wind measured values of the combination sensor can be monitored.
- In conjunction with DCF77 reception, automatic shading of up to four façades with slat readjustment in dependence on the sun position can be implemented.
- The synchronization of the internal time can optionally take place via the DCF77 receiver of the combination sensor or via a different bus devices.

- Up to four analog sensors providing output signals of 0 ... 1 VDC, 0 ... 10 VDC, 0 ... 20 mADC, 4 ... 20 mADC can be directly connect to the weather station.
- The connections to sensors with 4 ... 20 mA outputs can be monitored for wire breakage(open circuit).
- For selected weather sensors (wind, brightness, twilight, precipitation, temperature, air humidity, atmospheric pressure) pre-configured software settings are available.
- The measured values of the weather sensors (with the exception of the precipitation sensor) can be output in 16-bit form. Output can take place when values change or in cycles.
- The measured values of the analog sensors can be output in 16-bit or in 8-bit form. Output can take place when values change or in cycles.
- The precipitation sensor outputs are 1-bit values.
- For each of the analog sensors and for the weather sensors (with the exception of the precipitation sensor), two limit values with definable hystereses are available.
- These limit values can be externally preset as 8-bit or 16-bit values.
- In case of analog inputs and weather sensors (with the exception of wind and precipitation) the current measured value can also be saved as the new measured value via a 1-bit input (Teach-In-function).

- Up to 16 blocking modules facilitate the filtering of 1-bit, 8-bit or 16-bit values.
- Up to 20 logic gates with up to eight inputs each can be used.
- AND, OR and exclusive OR can be selected as logic functions.
- The inputs and outputs of the logic gates can be inverted.

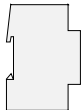





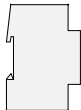

Combination Sensor Object Description

Object	Object description
<p>☐→ 0...200 Measured value, brightness and twilight [Max. brightness and twilight]</p>	<p>2 byte object to transmit the current maximum brightness/twilight value to the bus. The weather station evaluates the three directional brightness sensors and the twilight sensor of the combination sensor and calculates the greatest sensor value, which is then transmitted to the bus via this communication object.</p>
<p>☐→ 0...200 Connection error [combination sensor]</p>	<p>1-bit object to indicate when the electrical connection between the weather station and the combination sensor is interrupted. Object value = "0": no error. Object value = "1": error.</p>
<p>☐→ 0...200 Wind sensor error 1 (possibly iced up) [combination sensor]</p>	<p>1-bit object to indicate when the wind sensor has not detected any wind movement for a longer period. Please refer to "Max time for 'no wind', measured in hours". Object value = "0": no error. Object value = "1": error.</p>
<p>☐→ 0...200 Wind signal error 2 [combination sensor]</p>	<p>1-bit object to indicate when the wind sensor has not detected any wind change for a longer period. Please refer to "Max time for 'wind unchanged', measured in minutes". Object value = "0": no error. Object value = "1": error.</p>
<p>☐→ 0...200 Sun measured value [sun ...]</p>	<p>2-byte objects to output of the current illuminance. In this connection, there is one separate communication object for each of the three directions of east, south and west. A variable measured-value readjustment option and/ or a cycle time is/are available as transmitting criterion/criteria.</p>
<p>☐→ 0...200 Sun measured value [sun ...]</p>	<p>1-bit objects to indicate when the preset limit values (1 or 2) are being exceeded or underrun. Limit values, hystereses and transmitting criteria can be set in a separate dialog.</p>
<p>☐← 0...200 External limit value ... [sun ...]</p>	<p>1-byte or 2-byte objects to adapt the limit values by other bus devices (e. g. touch sensor as value transmitter, visualization). These values will overwrite the parameterized ones.</p>
<p>☐← 0...200 Limit value ... save (Teach-In) [sun ...]</p>	<p>1-bit object that sets the current measured value as the new limit value when receiving a telegram with the value „1“. "0" telegrams will be ignored. The new limit value will overwrite the parameterized value.</p>
<p>☐→ 0...200 Twilight measured value (lux) [twilight]</p>	<p>2-byte object to output of the current illuminance. The twilight stage is determined by a sensor directed to north. A variable measured-value readjustment option and/or a cycle time is/are available as transmitting criterion/ criteria.</p>
<p>☐→ 0...200 Limit value... [twilight]</p>	<p>1-bit objects to indicate when the preset limit values (1 or 2) are being exceeded or underrun. Limit values, hystereses and transmitting criteria can be set in a separate dialog.</p>
<p>☐← 0...200 External limit value ... [twilight]</p>	<p>1-byte or 2-byte objects to adapt the limit values by other bus devices (e. g. touch sensor as value transmitter, visualization). These values will overwrite the parameterized ones.</p>



Object	Object description
<input type="checkbox"/> 0...200 Limit value ... save (Teach-In) [twilight]	1-bit object that will set the current measured value as the new limit value when receiving a „1“ telegram“. „0“ telegrams will be ignored. The new limit value will overwrite the parameterized value.
<input type="checkbox"/> 0...200 Wind measured value (m/s) [wind]	2-byte object for the output of the current wind speed. A variable measured-value readjustment option and/or a cycle time is/are available as transmitting criterion/criteria.
<input type="checkbox"/> 0...200 Limit value ... [wind]	1-bit objects to indicate when the preset limit values (1 or 2) are being exceeded or underrun. Limit values, hystereses and transmitting criteria can be set in a separate dialog.
<input type="checkbox"/> 0...200 External limit value ... [wind]	1-byte or 2-byte objects to adapt the limit values by other bus devices (e. g. touch sensor as value transmitter, visualization). These values will overwrite the parameterized values.
<input type="checkbox"/> 0...200 Precipitation [precipitation]	1-bit object to indicate when rain is falling. The object value depends on the "Output" parameter. Presetting: Object value = "0": No precipitation. Object value = "1": Precipitation.
<input type="checkbox"/> 0...200 Azimuth [combination sensor – DCF77]	1-byte object to indicate the current sun position. Object value = "0°": North. Object value = "90°": East. Object value = "180°": South. Object value = "270°": West. The current date and time information of the DCF77 receiver and the geographical position of the building are used for calculation. Either the DCF77 receiver of the combination sensor or an external clock can be used to synchronize the time
<input type="checkbox"/> 0...200 Elevation [combination sensor – DCF77]	1-byte object to indicate the current position of the sun.



Object	Object description
<p> 0...200 Façade shading ... [Façades 1-4 shading control]</p>	<p>1-bit or 1-byte object to indicate that the respective façade is being exposed to sun radiation to such an extent as to require automatic shading. In case of 1-bit objects they can be connected with the Long-time objects of the respective actuators</p> <p>Object value = „0“: moving up the shutter/blinds Object value = „1“: moving down the shutter/blinds</p> <p>There will be an adjustable pause before the slats are positioned so that the shutter/blinds can be moved down. In case of 1-byte objects they can be connected with the Long-time objects of the respective actuators</p> <p>Object value = „0%“: moving up the shutter/blinds Object value = „100%“: moving down the shutter blinds</p> <p>A pause between the telegram for moving the shutter/blinds and the following positioning of the slats is not required as the actuators in this case can internally store the value of the slat position.</p>
<p> 0...200 Façade shading ... blind/shutter elevation threshold ... [façade individual control ...]</p>	<p>1-bit objects that allow the control of the shutter/blind elevation with up to three thresholds per Façade. These objects may be used to connect with actuators where parameterizable positions can be called up via switching objects. If the elevation has exceeded a threshold, the object will be set to „1“. In case of falling below the threshold the object will be reset to „0“.</p>
<p> 0...200 Façade shading ... blind shutter elevation threshold / position [Façade individual control ...]</p>	<p>1-byte objects that allow the control of the shutter/blind elevation with up to three thresholds per Façade. This object may be used to connect with actuators where positions can be called up as percentage values. In case the elevation exceeds or falls short of the threshold values, the object will be set to parameterizable values.</p>
<p> 0...200 Slat position ... Façade ... [Façade individual control ...]</p>	<p>1-byte object to control the slats in accordance with the sun position. Depending on the shutter/blind actuators used, positioning can be effected on the basis of relative values or angle values. According to the mechanical valve travel of the slats the values can be adjusted for the minimum and maximum position of the slats.</p>
<p> 0...200 Façade shading ... blocking [Façade individual control ...]</p>	<p>1-bit objects that allow to block or enable the automatic shading of each individual Façade. During the blocking the objects for shading, slat position and blind/shutter elevation of this Façade will not transmit any telegrams.</p>
<p> 0...200 Façade opening angle ... [Façades 1-4 individual control]</p>	<p>1-Byte objects to adapt the opening angle for up to four Façades via other bus devices (e.g. touch sensor as a value transmitter, visualization). These values will overwrite the parameterized values.</p>



Object	Object description
<input type="checkbox"/> 0...200 External basic brightness [façades 1-4 shading]	1-byte object to adapt the basic brightness for automatic shading by other bus devices (e. g. touch sensor as value transmitter, visualization). These values will overwrite the parameterized ones.
<input type="checkbox"/> 0...200 Date/time request [combination sensor – DCF77]	1-bit object to request the current time and date.
<input type="checkbox"/> 0...200 Date [combination sensor – DCF77]	3-byte object to send the current date.
<input type="checkbox"/> 0...200 Time [combination sensor – DCF77]	3-byte object to send the current time..
<input type="checkbox"/> 0...200 No DCF77 reception [combination sensor]	1-bit object to issue a warning if no DCF77 reception is possible.
<input type="checkbox"/> 0...200 Date/time request [combination sensor – external clock]	1-bit object for the combination sensor to request the current time and date from the external clock for the synchronization. The request can take place every hour or every day.
<input type="checkbox"/> 0...200 Date [combination sensor – external clock]	3-byte object to receive the current date from the external clock.
<input type="checkbox"/> 0...200 Time [combination sensor – external clock]	3-byte object to receive the current time from the external clock.
<input type="checkbox"/> 0...200 Error external clock [combination sensor]	1-bit object the weather station can send, if during an activated control of an external clock no date or time telegram is received within 5 minutes of the request.
<input type="checkbox"/> 0...200 Automatic time switch [combination switch]	1-bit object which allows to switch the internal clock of the weather station to daylight saving time in case the synchronization takes place via an external clock. Object value = „0“: no daylight saving time Object value = „1“: daylight saving time

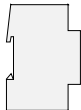

Analog input object description

Object	Object description
<p>☐→ 0...200 Alarm object – 1-bit [analog input]</p>	<p>1-bit object for a message when a problem such as some overvoltage at an input of the weather station or some overloading of the supply voltage for external sensors has occurred. Direct assignment to the cause of the problem will not be possible. Object value = "0": No alarm. Object value = "1": Alarm.</p>
<p>☐→ 0...200 Measured value [analog input ...]</p>	<p>1-byte or 2-byte object to output the current measured value. A variable measured-value readjustment option and/or a cycle time is/are available as transmitting criterion/criteria.</p>
<p>☐→ 0...200 Limit value [analog input... – ...]</p>	<p>1-bit objects to indicate when the preset limit values (1 or 2) are being exceeded or underrun. Permits the setting of limit values, hystereses and transmitting criteria in a separate dialog.</p>
<p>☐← 0...200 External limit value [analog input... – ...]</p>	<p>1-byte or 2-byte objects to adapt the limit values by other bus devices (e. g. touch sensor as value transmitter, visualization).</p>
<p>☐← 0...200 Limit value... save (Teach-In) [analog input ... – ...]</p>	<p>1-bit object to save the current measured value as the new limit value when receiving a telegram with the value „1“ . Telegrams with the value „0“ will be ignored. The new limit value will overwrite the parameterized value.</p>
<p>☐→ 0...200 Wire breakage [analog input ... – 4 ... 20 mA]</p>	<p>1-bit object to indicate when a wire breakage has occurred on a connected sensor with a measuring range of 4 ... 20 mA. The object value depends on the "Output" parameter. Presetting: Object value = "0": No open circuit (wire breakage). Object value = "1": Open circuit (wire breakage).</p>
<p>☐→ 0...200 Wind measured value (m/s) [analog input ...– wind]</p>	<p>2-byte object to output the current wind speed when a wind sensor is used. A variable measured-value readjustment option and/or a cycle time is/are available as transmitting criterion/criteria.</p>
<p>☐→ 0...200 Limit value 1 [analog input ... – wind]</p>	<p>1-bit objects to indicate when the preset limit values (1 or 2) are being exceeded or underrun. Permits the setting of limit values, hystereses and transmitting criteria in a separate dialog.</p>
<p>☐← 0...200 External limit value [analog input... – wind]</p>	<p>1-byte or 2-byte objects to adapt the limit values by other bus devices (e. g. touch sensor as value transmitter, visualization). These values will overwrite the parameterized ones.</p>
<p>☐→ 0...200 Brightness measured value (lux) [analog input... – brightness]</p>	<p>2-byte object to output the current illuminance when a brightness sensor is used. A variable measured-value readjustment option and/or a cycle time is/are available as transmitting criterion/criteria.</p>



Object	Object description
<input type="checkbox"/> 0...200 Limit value... [analog input... – brightness]	1-bit objects to indicate when the preset limit values (1 or 2) are being exceeded or underrun. Permits the setting of limit values, hystereses and transmitting criteria in a separate dialog.
<input type="checkbox"/> 0...200 External Limit value ... [analog input ... – brightness]	1-byte or 2-byte objects to adapt the limit values by other bus devices (e. g. touch sensor as value transmitter, visualization). These values will overwrite the parameterized ones.
<input type="checkbox"/> 0...200 Limit value ... save (Teach-In) [analog input ... – brightness]	1-bit object to save the current measured value as the new limit value when receiving a telegram with the value „1“. Telegrams with the value „0“ will be ignored. The new limit value will overwrite the parameterized value.
<input type="checkbox"/> 0...200 Twilight measured value (lux) [analog input... – twilight]	2-byte object to output the current illuminance when a twilight sensor is used. A variable measured-value readjustment option and/or a cycle time is/are available as transmitting criterion/criteria.
<input type="checkbox"/> 0...200 Limit value 1 [analog input... – twilight]	1-bit objects to indicate when the preset limit values (1 or 2) are being exceeded or underrun. Permits the setting of limit values, hystereses and transmitting criteria in a separate dialog.
<input type="checkbox"/> 0...200 External limit value... [analog input... – twilight]	1-byte or 2-byte objects to adapt the limit values by other bus devices (e. g. touch sensor as value transmitter, visualization). These values will overwrite the parameterized ones.
<input type="checkbox"/> 0...200 Limit value ... save (Teach-In) [analog input ... – twilight]	1-bit object to save the current measured value as the new limit value when receiving a telegram with the value „1“. Telegrams with the value „0“ will be ignored. The new limit value will overwrite the parameterized value.
<input type="checkbox"/> 0...200 Atmospheric pressure measured value (Pa) [analog input... – atmospheric pressure]	2-byte object to output the current atmospheric pressure when an atmospheric pressure sensor with a measuring range of 70000 to 120000 Pa is used. A variable measured-value readjustment option and/or a cycle time is/are available as transmitting criteria.
<input type="checkbox"/> 0...200 Limit value ... [analog input... – atmospheric pressure]	1-bit objects to indicate when the preset limit values (1 or 2) are being exceeded or underrun. Permits the setting of limit values, hystereses and transmitting criteria in a separate dialog.
<input type="checkbox"/> 0...200 External limit value x [analog input... – atmospheric pressure]	1-byte or 2-byte objects to adapt the limit values by other bus devices (e. g. touch sensor as value transmitter, visualization). These values will overwrite the parameterized ones.
<input type="checkbox"/> 0...200 Limit value ... save (Teach-In) [analog input ... – atmospheric pressure]	1-bit object to save the current measured value as the new limit value when receiving a telegram with the value „1“. Telegrams with the value „0“ will be ignored. The new limit value will overwrite the parameterized value.

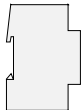

Object	Object description
<p>☐→ 0...200 Temperature measured value (°C) [analog input... – temperature]</p>	<p>2-byte object to output the current temperature when a temperature sensor is used. A variable measured-value readjustment option and/or a cycle time is/are available as transmitting criterion/criteria.</p>
<p>☐→ 0...200 Limit value x [analog input... – temperature]</p>	<p>1-bit objects to indicate when the preset limit values (1 or 2) are being exceeded or underrun. Permits the setting of limit values, hystereses and transmitting criteria in a separate dialog.</p>
<p>☐← 0...200 External limit value... [analog input... – temperature]</p>	<p>1-byte or 2-byte objects to adapt the limit values by other bus devices (e. g. touch sensor as value transmitter, visualization). These values will overwrite the parameterized ones.</p>
<p>☐← 0...200 Limit value ... save (Teach-In) [analog input ... – atmospheric pressure]</p>	<p>1-bit object to save the current measured value as the new limit value when receiving a telegram with the value „1“. Telegrams with the value „0“ will be ignored. The new limit value will overwrite the parameterized value.</p>
<p>☐→ 0...200 Air humidity measured value (% RH) [analog input... – air humidity]</p>	<p>2-byte object to output the current relative air humidity when a humidity sensor is used. A variable measured-value readjustment option and/or a cycle time is/are available as transmitting criterion/criteria.</p>
<p>☐→ 0...200 Limit value 1 [analog input... – air humidity]</p>	<p>1-bit objects to indicate when the preset limit values (1 or 2) are being exceeded or underrun. Permits the setting of limit values, hystereses and transmitting criteria in a separate dialog.</p>
<p>☐← 0...200 External limit value... [analog input... – air humidity]</p>	<p>1-byte or 2-byte objects to adapt the limit values by other bus devices (e. g. touch sensor as value transmitter, visualization). These values will overwrite the parameterized ones.</p>
<p>☐← 0...200 Limit value ... save (Teach-In) [analog input ... – humidity]</p>	<p>1-bit object to save the current measured value as the new limit value when receiving a telegram with the value „1“. Telegrams with the value „0“ will be ignored. The new limit value will overwrite the parameterized value.</p>
<p>☐→ 0...200 Precipitation [analog input x – precipitation]</p>	<p>1-bit object for indication when a rain sensor is used. The object value depends on the "Output" parameter. Presetting: Object value = "0": No precipitation. Object value = "1": Precipitation.</p>



Blocking Module Object Descriptions ¹⁾

Object	Object description
□← 0...200 Blocking module [input – switching – 1-bit]	1-bit object, the value of which is passed on to the output object of the blocking module in dependence on the value of the associated blocking object.
□→ 0...200 Blocking module [output – switching – 1-bit]	1-bit object which the value of the input object is passed on to.
□← 0...200 Blocking module [input – rel. value – 1-byte]	1-byte object, the value of which is passed on to the output object of the blocking module in dependence on the value of the associated blocking object.
□→ 0...200 Blocking module [output – rel. value – 1-byte]	1-byte object which the value of the input object is passed on to.
□← 0...200 Blocking module [input – value – 2-byte]	2-byte object, the value of which is passed on to the output object of the blocking module in dependence on the value of the associated blocking object.
□→ 0...200 Blocking module [input – value – 2-byte]	2-byte object which the value of the input object is passed on to.
□← 0...200 Blocking module [blocking object]	1-bit object which determines whether the value of the associated input object will be passed on to the output object. Permits setting the response of the blocking object. Presetting: Object value = "0": Blocked. Object value = "1": Released.

Logic controller object description

Object	Object description
□← 0...200 Input [logic gate input]	1-bit objects which are gated with each other. Each input object of a logic gate can be used in the normal way or in inverted form.
□→ 0...200 Output [logic gate output]	1-bit object which outputs the result of the logic gating. The type of gating (AND, OR, EXCLUSIVE OR), the behaviour (normal or inverted) and the transmitting criterion (transmit upon each input event, or transmit upon output change) can be set.

¹⁾ In the device software, the name of the blocking module and thus also the names of the communication objects can be set. This facilitates easier configuring and better documentation.

instabus KNX/EIB System

Sensor

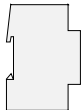

Number of addresses (max):	200	dynamic table handling	Yes <input type="checkbox"/>	No <input checked="" type="checkbox"/>
Number of assignments (max):	200	maximum length of table	200	
Communication objects	max. 200 (dynamically created)			

Combination sensor

Object	Name ²⁾	DPT-ID	Format	Flags
0...200	Measured value, brightness and twilight [Max. brightness and twilight]	9.004	2-byte	C, T, R
0...200	Connection error [combination sensor]	1.001	1-bit	C, T
0...200	Error 1 wind sensor (possibly iced up)[combination sensor]	1.001	1-bit	C, T
0...200	Error 2 wind signal [combination sensor]	1.001	1-bit	C, T
0...200	Sun measured value [sun east]	9.004	2-byte	C, T
0...200	Limit value 1 [sun east]	1.001	1-bit	C, T
0...200	Limit value 2 [sun east]	1.001	1-bit	C, T
0...200	External limit value ... [sun east]	9.004	2-byte	C, W, T, R
0...200	External limit value ... [%] [sun east]	5.001	1-byte	C, W, T, R
0...200	Limit value ... save (Teach-In) [sun east]	1.001	1-bit	C, W
0...200	Sun measured value [sun south]	9.004	2-byte	C, T
0...200	Limit value 1 [sun south]	1.001	1-bit	C, T
0...200	Limit value 2 [sun south]	1.001	1-bit	C, T
0...200	External limit value ... [sun south]	9.004	2-byte	C, W, T, R
0...200	External limit value ... [%] [sun south]	5.001	1-byte	C, W, T, R
0...200	Limit value ... save (Teach-In) [sun south]	1.001	1-bit	C, W
0...200	Sun measured value [sun west]	9.004	2-byte	C, T
0...200	Limit value 1 [sun west]	1.001	1-bit	C, T
0...200	Limit value 2 [sun west]	1.001	1-bit	C, T
0...200	External limit value ... [sun west]	9.004	2-byte	C, W, T, R
0...200	External limit value ... [%] [sun west]	5.001	1-byte	C, W, T, R
0...200	Limit value ... save (Teach-In) [sun west]	1.001	1-bit	C, W
0...200	Twilight measured value (lux) [twilight]	9.004	2-byte	C, T
0...200	Limit value 1 [twilight]	1.001	1-bit	C, T
0...200	Limit value 2 [twilight]	1.001	1-bit	C, T
0...200	External limit value ... [twilight]	9.004	2-byte	C, W, T, R
0...200	External limit value ... [%] [twilight]	5.001	1-byte	C, W, T, R
0...200	Limit value ... save (Teach-In) [twilight]	1.001	1-bit	C, W
0...200	Wind measured value (m/s) [wind]	9.005	2-byte	C, T
0...200	Limit value 1 [wind]	1.001	1-bit	C, T
0...200	Limit value 2 [wind]	1.001	1-bit	C, T
0...200	External limit value ... [wind]	9.005	2-byte	C, W, T, R
0...200	External limit value ... [wind]	5.001	1-byte	C, W, T, R
0...200	Precipitation [precipitation]	1.001	1-bit	C, T

¹⁾ The communication objects will be created dynamically via the ETS plug-in on demand. The ETS2 does not support the adjustment of the communication object names. Instead, it shows the names in the form „Object 0 – 1bit“. In the ETS 3 the communication objects will show the same names as in the ETS-Plug-In.



Sensor

Combination sensor

Object	Name	DPT-ID	Format	Flags
0...200	Azimuth [combination sensor – DCF77]	5.003	1-byte	C, T, R
0...200	Elevation [combination sensor – DCF77]	5.003	1-byte	C, T, R
0...200	Facade shading ... [facades 1-4 shading control]	1.001	1-bit	C, T
0...200	Facade shading ... [facades 1-4 shading control]	5.001	1-byte	C, T
0...200	Facade shading ... curtain height threshold 1 [façade individual control ...]	1.001	1-bit	C, T
0...200	Facade shading ... curtain height threshold 2 [façade individual control ...]	1.001	1-bit	C, T
0...200	Facade shading ... curtain height threshold 3 [façade individual control ...]	1.001	1-bit	C, T
0...200	Facade shading ... curtain height threshold/position [individual control facade ...]	5.001	1-byte	C, T
0...200	Slat position (%) facade ... [façade individual control ...]	5.001	1-byte	C, T
0...200	Façade shading ... blocking [façade individual control ...]	1.001	1-bit	C, W
0...200	Opening angle facade 1 [facades 1-4 individual control]	5.003	1-byte	C, W
0...200	Opening angle facade 2 [facades 1-4 individual control]	5.003	1-byte	C, W
0...200	Opening angle facade 3 [facades 1-4 individual control]	5.003	1-byte	C, W
0...200	Opening angle facade 4 [facades 1-4 individual control]	5.003	1-byte	C, W
0...200	Ext. Basic brightness [facades 1-4 shading]	5.001	1-byte	C, W
0...200	Date [combination sensor – DCF77]	11.001	3-byte	C, T ³⁾
0...200	Time [combination sensor – DCF77]	10.001	3-byte	C, T ³⁾
0...200	Date / time request [combination sensor – DCF77]	1.001	1-bit	C, W
0...200	Date [combination sensor – External clock]	11.001	3-byte	C, W
0...200	Time [combination sensor – External clock]	10.001	3-byte	C, W
0...200	Date / time request [combination sensor – External clock]	1.001	1-bit	C, T
0...200	No DCF77 reception [combination sensor]	1.001	1-bit	C, T
0...200	Error external clock [combination sensor]	1.001	1-bit	C, T
0...200	Automatic clock change [combination sensor]	1.001	1-bit	C, W

³⁾ The flags of the date and time communication objects of the DCF77 receiver have to be set such that they cannot be read out. This prevents the transmission of invalid values.
The „date/time request“ communication object is available instead. The response to such a request can take up to a minute.

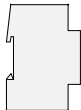

Analog input

Object	Name	DPT-ID	Format	Flags
☐	0...200 Alarm object – 1Bit [analog input]	1.001	1-bit	C, T
☐	0...200 Measured value [analog input ... – 0 ... 10V]	9.020	2-byte	C, T
☐	0...200 Measured value [analog input ... – 0 ... 10V]	5.001	1-byte	C, T
☐	0...200 Limit value 1 [analog input ... – 0 ... 10V]	1.001	1-bit	C, T
☐	0...200 Limit value 2 [analog input ... – 0 ... 10V]	1.001	1-bit	C, T
☐	0...200 External limit value ... [analog input ... – 0 ... 10V]	9.020	2-byte	C, W, T, R
☐	0...200 External limit value ... [%] analog input ... – 0 ... 10V]	5.001	1-byte	C, W, T, R
☐	0...200 Limit value ... save (Teach-In) [analog input ... – 0 ... 10V]	1.001	1-bit	C, W
☐	0...200 Measured value [analog input ... – 0 ... 1V]	9.020	2-byte	C, T
☐	0...200 Measured value [analog input ... – 0 ... 1V]	5.001	1-byte	C, T
☐	0...200 Limit value 1 [analog input ... – 0 ... 1V]	1.001	1-bit	C, T
☐	0...200 Limit value 2 [analog input ... – 0 ... 1V]	1.001	1-bit	C, T
☐	0...200 External limit value ... [analog input ... – 0 ... 1V]	9.020	2-byte	C, W, T, R
☐	0...200 External limit value ... [%] [analog input ... – 0 ... 1V]	5.001	1-byte	C, W, T, R
☐	0...200 Limit value ... save (Teach-In) [analog input ... – 0 ... 1V]	1.001	1-bit	C, W
☐	0...200 Measured value [analog input ... – 0 ... 20mA]	9.021	2-byte	C, T
☐	0...200 Measured value [analog input ... – 0 ... 20mA]	5.001	1-byte	C, T
☐	0...200 Limit value 1 [analog input ... – 0 ... 20mA]	1.001	1-bit	C, T
☐	0...200 Limit value 2 [analog input ... – 0 ... 20mA]	1.001	1-bit	C, T
☐	0...200 External limit value ... [analog input ... – 0 ... 20mA]	9.021	2-byte	C, W, T, R
☐	0...200 External limit value ... [%] [analog input ... – 0 ... 20mA]	5.001	1-byte	C, W, T, R
☐	0...200 Limit value ... save (Teach-In) [analog input ... – 0 ... 20mA]	1.001	1-bit	C, W
☐	0...200 Measured value [analog input ... – 4 ... 20mA]	9.021	2-byte	C, T
☐	0...200 Measured value [analog input ... – 4 ... 20mA]	5.001	1-byte	C, T
☐	0...200 Limit value 1 [analog input ... – 4 ... 20mA]	1.001	1-bit	C, T
☐	0...200 Limit value 2 [analog input ... – 4 ... 20mA]	1.001	1-bit	C, T
☐	0...200 External limit value ... [analog input ... – 4 ... 20mA]	9.021	2-byte	C, W, T, R
☐	0...200 External limit value ... [%] [analog input ... – 4 ... 20mA]	5.001	1-byte	C, W, T, R
☐	0...200 Wire breakage [analog input ... – 4 ... 20mA]	1.001	1-bit	C, T
☐	0...200 Limit value ... save (Teach-In) [analog input ... – 4 ... 20mA]	1.001	1-bit	C, W
☐	0...200 Measured value wind (m/s) [analog input ... – wind]	9.005	2-byte	C, T
☐	0...200 Limit value 1 [analog input ... – wind]	1.001	1-bit	C, T
☐	0...200 Limit value 2 [analog input ... – wind]	1.001	1-bit	C, T
☐	0...200 External limit value ... [analog input ... – wind]	9.005	2-byte	C, W, T, R
☐	0...200 External limit value ... [%] [analog input ... – wind]	5.001	1-byte	C, W, T, R
☐	0...200 Measured value brightness (lux) [analog input ... – brightness]	9.004	2-byte	C, T
☐	0...200 Limit value 1 [analog input ... – brightness]	1.001	1-bit	C, T
☐	0...200 Limit value 2 [analog input ... – brightness]	1.001	1-bit	C, T



Sensor

Analog input

Object	Name	Object	Name	Object
0...200	External limit value... [analog input ... – brightness]	9.004	2-byte	C, W, T, R
0...200	External limit value ... [%] [analog input ... – brightness]	5.001	1-byte	C, W, T, R
0...200	Limit value ... save (Teach-In) [analog input ... – brightness]	1.001	1-bit	C, W
0...200	Twilight measured value twilight (lux) [analog input ... – twilight]	9.004	2-byte	C, T
0...200	Limit value 1 [analog input ... – twilight]	1.001	1-bit	C, T
0...200	Limit value 2 [analog input ... – twilight]	1.001	1-bit	C, T
0...200	External limit value ... [analog input ... – twilight]	9.004	2-byte	C, W, T, R
0...200	External limit value ... [%] [analog input ... – twilight]	5.001	1-byte	C, W, T, R
0...200	Limit value ... save (Teach-In) [analog input ... – twilight]	1.001	1-bit	C, W
0...200	Atmospheric pressure measured value (Pa) [analog input ... – atmospheric pressure]	9.006	2-byte	C, T
0...200	Limit value 1 [analog input ... – atmospheric pressure]	1.001	1-bit	C, T
0...200	Limit value 2 [analog input ... – atmospheric pressure]	1.001	1-bit	C, T
0...200	External limit value ... [analog input ... – atmospheric pressure]	9.006	2-byte	C, W, T, R
0...200	External limit value ... [%] [analog input ... – atmospheric pressure]	5.001	1-byte	C, W, T, R
0...200	Limit value ... save (Teach-In) [analog input ... – atmospheric pressure]	1.001	1-bit	C, W
0...200	Measured temperature (°C) [analog input ... – temperature]	9.001	2-byte	C, T
0...200	Limit value 1 [analog input ... – temperature]	1.001	1-bit	C, T
0...200	Limit value 2 [analog input ... – temperature]	1.001	1-bit	C, T
0...200	External limit value ... [analog input ... – temperature]	9.001	2-byte	C, W, T, R
0...200	External limit value ... [%] [analog input ... – temperature]	5.001	1-byte	C, W, T, R
0...200	Limit value ... save (Teach-In) [analog input ... – temperature]	1.001	1-bit	C, W
0...200	Humidity measured value (%r.F.) [analog input ... – humidity]	9.0xx	2-byte	C, T
0...200	Limit value 1 [analog input ... – humidity]	1.001	1-bit	C, T
0...200	Limit value 2 [analog input ... – humidity]	1.001	1-bit	C, T
0...200	External limit value ... [analog input ... – humidity]	9.0xx	2-byte	C, W, T, R
0...200	External limit value ... [%] [analog input ... – humidity]	5.001	1-byte	C, W, T, R
0...200	Limit value ... save (Teach-In) [analog input ... – humidity]	1.001	1-bit	C, W
0...200	Precipitation [analog input ... – precipitation]	1.001	1-bit	C, W, T, R

Sensor



Blocking module ⁴⁾

Object	Name	Object	Name	Object
□← 0...200	Blocking module [input – switching – 1 Bit]	1.001	1-bit	C, W
□→ 0...200	Blocking module [output – switching – 1 Bit]	1.001	1-bit	C, T
□← 0...200	Blocking module [blocking object]	1.001	1-bit	C, W
□← 0...200	Blocking module [input – value – 2-Byte]	9.0xx	2-byte	C, W
□→ 0...200	Blocking module [output – value – 2-Byte]	9.0xx	2-byte	C, T
□← 0...200	Blocking module [blocking object]	1.001	1-bit	C, W
□← 0...200	Blocking module [input – rel. value – 1-Byte]	5.001	1-byte	C, W
□→ 0...200	Blocking module [output – Rel. value – 1-Byte]	5.001	1-byte	C, T
□← 0...200	Blocking module [blocking object]	1.001	1-bit	C, W

Logic controller ⁵⁾

Object	Name	Object	Name	Object
□← 0...200	Logic gate – AND [logic gate input] ⁶⁾	1.001	1-bit	C, W
□↔ 0...200	Logic gate – AND [logic gate output]	1.001	1-bit	C, W, T, R
□← 0...200	Logic gate – OR [logic gate input] ⁶⁾	1.001	1-bit	C, W
□↔ 0...200	Logic gate – OR [logic gate output]	1.001	1-bit	C, W, T, R
□← 0...200	Logic gate – XOR [logic gate input] ⁶⁾	1.001	1-bit	C, W
□↔ 0...200	Logic gate – XOR [logic gate output]	1.001	1-bit	C, W, T, R
□← 0...200	Logic gate – AND with feedback [logic gate input] ⁶⁾	1.001	1-bit	C, W
□↔ 0...200	Logic gate – AND with feedback [logic gate output]	1.001	1-bit	C, W, T, R

⁴⁾ The number of the available blocking modules and logic controllers as well as of the available inputs per logic gate depends on the configuration/number of the utilized communication objects of the device. The maximum number of communication objects is 200.

⁵⁾ The number of the available blocking modules and logic controllers as well as of the available inputs per logic gate depends on the configuration/number of the utilized communication objects of the device. The maximum number of communication objects is 200.

⁶⁾ A maximum of eight inputs is available for each logic gate.



Table of contents

Functional description:	1
Illustration:	2
Technical data:	3
Wiring diagram and terminal assignment:	4
Combination sensor alignment and installation	5
Internal sensor position:	5
Combination sensor orientation	5
DCF receiver alignment.....	6
Alignment without electrical connection.....	6
Alignment with electrical connection.....	6
Remarks on the Hardware	7
Application: Weather station B00602	9
Function Scope.....	9
Combination Sensor Object Description	10
Analog input object description	14
Blocking Module Object Descriptions ¹⁾	17
Logic controller object description	17
Functional Description	25
1 Configuration Basic Settings	25
2 Connection with a Digital Combination Sensor	26
2.1 Date / time / astro function.....	27
2.1.1 DCF77 reception	28
2.1.2 External clock	29
2.1.3 Location	30
2.2 Twilight.....	30
2.3 Brightness.....	31
2.4 Wind speed.....	32
2.5 Precipitation	32
3 Connection with Analog Weather Sensors	33
3.1 Wind speed.....	34
3.2 Brightness.....	34
3.3 Twilight.....	34
3.4 Temperature	35
3.5 Precipitation	35
3.6 Air humidity	35
3.7 Atmospheric pressure.....	36
4 Connection with other Analog Sensors	36
4.1 Setting the measuring range	36
4.2 Open-circuit monitoring	37



5	Software Functions	38
5.1	Measured-value conditioning	38
5.1.1	16-bit measured-value output	38
5.1.2	8-bit measured-value output	39
5.2	Limit values and hystereses	40
5.3	External limit values	41
5.3.1	Value presetting	41
5.3.2	Teach-In function	42
5.4	Blocking modules	43
5.5	Logic controller	44
5.6	Group addresses/internal group addresses	46
6	Automatic Shading	47
6.1	Calculating the sun position	48
6.2	Building orientation	50
6.3	Shutter/blind control	51
6.4	Control of the curtain height	52
6.5	Blocking the shading for each Façade	53
7	Protection of Awnings and Outer Blinds	54
7.1	Wind speed	54
7.2	Frost protection	55
7.3	Note on parameter configuration of logic gates for awning and external shutter protection	56
8	Getting Started	57
8.1	Initialization/status indications	57
8.2	Plug-in options	57
8.2.1	Table	57
8.2.2	Options	58
8.2.3	Hardware	58
9	Using the weather station in combination with different actuators	60
9.1	Simple sun protection with shutter/blind actuator	60
9.2	Simple sun protection with blind/shutter actuator	60
9.3	Sun protection with fixed curtain height and slat tracking in the shutter/blind actuator	61
9.4	Sun protection with fixed curtain height and slat tracking in the shutter/blind actuator	61
9.5	Sun protection with variable curtain height and slat tracking in the shutter/blind actuator	62
9.6	Simple sun protection with shutter/blind actuator order no. 1039 00	63
9.7	Simple sun protection with shutter/blind actuator order no. 1039 00	63
9.8	Sun protection with fixed curtain height and slat tracking in shutter/blind actuator order no. 1039 00	64
9.9	Sun protection with variable curtain height and slat tracking in the shutter/blind actuator order no. 1039 00	66
9.10	Sun protection with variable curtain height and fixed slat position in shutter/blind actuator order no. 1039 00	67
	Parameters	69
	Remarks on the software	89



Functional Description

The function of the weather station and of the sensors connected to it is to be adjusted via an ETS plug-in. In this connection, the communication objects required for each function are created dynamically. This is the reason why there is no fixed assignment between the individual functions and the numbers of the communication objects.

In order to obtain coherent representation in the configuration of the communication objects of the individual elements such as of an analog input it is recommended that each of the parameters of an individual sensor be set step by step before changing the next one.

1 Configuration Basic Settings

The weather station primarily serves to collect and pass on weather data or other analog signals. Different sensors can be used for this purpose:

- A digital combination sensor (with or without DCF77 reception) facilitates the measuring of the wind intensity, the brightness, the twilight stage and the detection of rain.
- Specific analog weather sensors allow, in each case, for the detection of weather-referred quantities. These are:
 - Brightness: Ordering no. 0576 00
 - Twilight: Ordering no. 0572 00
 - Wind: Ordering no. 0580 00
 - Precipitation: Ordering no. 0579 00
 - Temperature: Ordering no. 0577 00

Up to four of these sensors can be connected to the weather station in any combination, the device software providing pre-configured settings for them.

- In conjunction with an analog input module, up to four additional analog sensors can be connected.
- Instead of the specific analog weather sensors, other types of analog measuring sensors working in the following signal ranges can also be connected:
 - 0 ... 1 V DC,
 - 0 ... 10 V DC
 - 0 ... 20 mA DC
 - 4 ... 20 mA DC.

For such sensors, the device software will not provide any pre-configured settings. The parameters to be set must be specified separately .

In addition to pure measured-value acquisition, the weather station facilitates fully automatic control of shading facilities, depending on the position of the sun. Such control is based on the calculated position of the sun and on the illuminance measured.

Irrespective of the processing of analog values, the weather station provides logic controllers and blocking modules. In conjunction with the weather information collected, such software modules can implement more complex functions. However, they can also be used by the other device functions.



2 Connection with a Digital Combination Sensor

To be able to use the weather station together with a digital combination sensor select the "Modules" option in the tree structure shown in the configuration window where the combination sensor can be added as a new module.

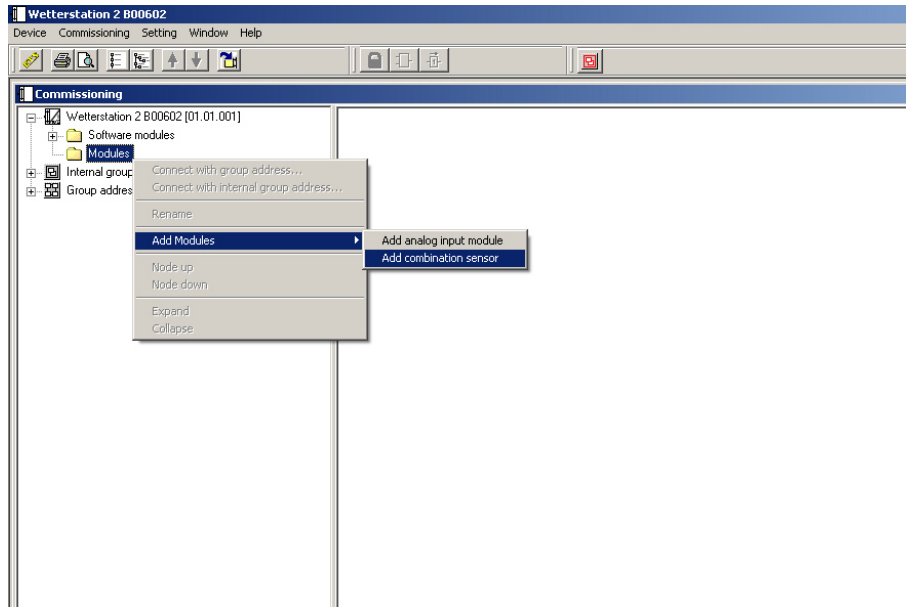

To reliably detect the beginning of dawn/dusk and to correctly determine the solar radiation during the course of the day align the combination sensor exactly to the North when mounting it to the pole.

When using the automatic shading function it is necessary to exactly align the sensor to the North.

Combination sensor alignment to the North

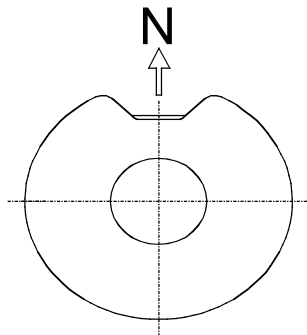



The top of the flat lower part of its enclosure must not be shaded by parts of buildings or trees.

Combination sensor side view

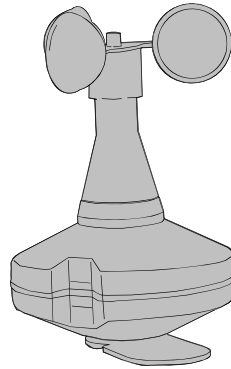

2.1 Date / time / astro function

If automatic shading as a function of the sun position is desired in addition to the pure collecting of weather information, the DCF77 reception and slat adjustment functions in the combination sensor must be enabled.

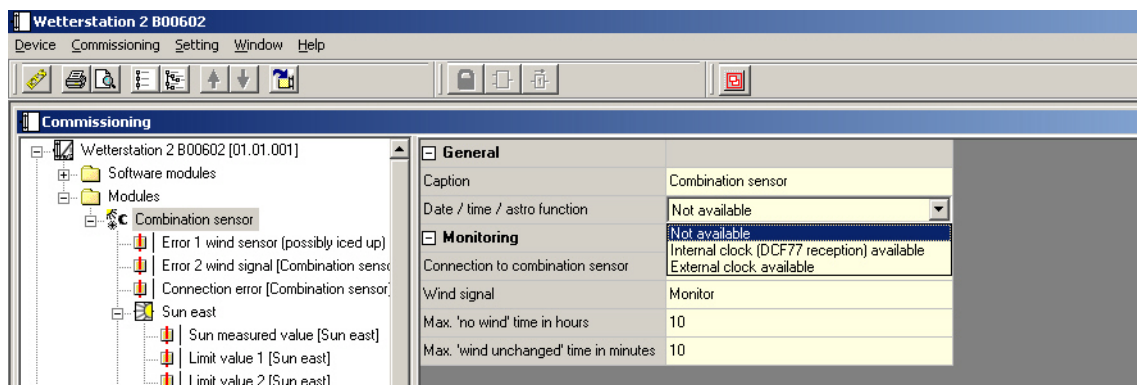



2.1.1 DCF77 reception

DCF77 reception can be used internally, on the one hand, and for synchronizing other devices (master function) such as timers or room temperature controllers with built-in time programs, on the other one.

General	
Caption	Combination sensor
Date / time / astro function	internal clock (DCF77 reception) available
Internal clock	
Request date/time by	1 telegram
cycl. sending date / time	1 / day
Astro function	
Send position of the sun in case of	5° change in elevation
Send sun position in cycles (0 = OFF, base = 10 s)	0
Position	
Location longitude	E 7,62°
Location latitude	N 51,22°
Monitoring	
Connection to combination sensor	Monitor
Wind signal	Monitor
Max. 'no wind' time in hours	10
Max. 'wind unchanged' time in minutes	10
DCF77 signal	Do not monitor

For the synchronization of other devices, the weather station can alternatively send the data every minute, every hour or once per day. If the DCF77 receiver sends the time and the date every hour, for example, the values of the communication objects will only be updated internally at those sending times. For this reason, set the flag so that the time and the date will not be read out. However, if the current time information is still needed, the weather station has an additional 1-bit "Date/time request" communication object. If this object receives a telegram with a selectable value the weather station will send the current time and date upon the next incoming DCF signal.



2.1.2 External clock

In case the building is located too far away from Frankfurt (Mainflingen) so that there may be no DCF77 reception, the internal clock of the weather station can also be synchronized by another bus user.

The screenshot shows the 'Wetterstation 2 B00602' configuration window. The left pane displays a tree view of modules under 'Wetterstation 2 B00602 [01.01.001]'. The right pane shows the configuration settings for the selected 'Combination sensor' module.

General	
Caption	Combination sensor
Date / time / astro function	External clock available
External clock	
Request date/time by	1 telegram
Cycl. request date / time	1 / day
Automatic time switch	Acc. to European standard
Astro function	
Send position of the sun in case of	5° change in elevation
Send sun position in cycles (0 = OFF, base = 10 s)	0
Position	
Location longitude	E 7,62°
Location latitude	N 51,22°
Monitoring	
Connection to combination sensor	Monitor
Wind signal	Monitor
Max. 'no wind' time in hours	10
Max. 'wind unchanged' time in minutes	10
External clock	Do not monitor

In this case the calculation of the current time and date will take place via a software timer whose cycle accuracy depends largely on the scope of the additional software functions. Without regular synchronization it might deviate several minutes per day. The weather station updates its internal clock with each new incoming date telegram and time telegram. In addition, the weather station can use the "date / time request" 1-bit communication object to synchronize itself. This communication object sends an adjustable value after each initialization (via a return of supply voltage or via new programming) and following that every hour (on the hour) or every day (at 4:15 for a reliable switch-over to daylight saving). After such a request the weather station will expect the telegrams with the current time and date within approx. 5 minutes. In case the two telegrams have not been received on time, the weather station will repeat the request periodically every five minutes. In addition, it can issue a failure report via the „Error external clock“ object with the value „1“, which will also be repeated every five minutes.

The „date“ and „time“ datapoint types do not contain any information whether the daylight saving time is enabled. For this reason it is possible to determine via the "Automatic time switch" parameter how the weather station will carry out the switch-over.

- The „According to European standard“ setting will cause the weather station to automatically adjust the time for the calculation of the sun's position between the last Sunday in March and the last Sunday in October.
- The „Via switching object“ setting will activate the "Automatic time switch" communication object. If the object has the value "1", the weather station will take into account the daylight saving time. If it has the value "0", the weather station will continue to use the regular time. In case of an initialization, the "Automatic time switch" object will send a read request onto the bus.
- The weather station will not carry out a switch-over in case of a „No“ setting.

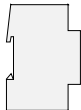

2.1.3 Location

In addition to the current time, the calculation of the sun's position and the automatic shading also requires the geographical position. This can be entered in a separate dialog. Instead of a numerical input it is also possible to select a nearby German or international city from a list.

The basic brightness that will trigger the shading has to be entered in the „Façades 1-4 shading“ branch in the configuration window as well as the orientation of the individual Façades in the following branches. Optionally, these values can be set internally or externally as variables, for example, via a visualization software. For a more detailed description see section „Automatic shading“.

2.2 Twilight

To detect twilight the combination sensor has a built-in sensor of its own which determines the illuminance from the North.

Its pre-configured measuring range covers 0 ... 674 lux.

To display the current illuminance the measured value can be sent at a selectable difference from the previous measured value. Sending the values in cycles is also possible.

Two selectable limit values are available where the weather station can send switching telegrams when these values are exceeded or underrun. Such limit values can either be fixed internally or set externally as variables through a visualization software, for example.

With the exception of the precipitation sensor, the setting of the limit values and of the hysteresis is the same for all weather sensors. This procedure is described in detail under "Software Functions – Limit values and hysteresis".

The weather station evaluates the three directional brightness sensors (see Chapter "2.3 Brightness") and the twilight sensor of the combination sensor and calculates the greatest sensor value of these four sensors, which can then be transmitted to the bus using the "Measured value, brightness and twilight" communication object, which can be enabled separately. This object can be enabled in the "Combination sensor" parameter branch. Its transmission behaviour can also be configured here.



2.3 Brightness

The combination sensor has a sensor of its own for each of the directions of East, South and West. Each of these sensors has the same setting options.

The three detection ranges of the sensors are somewhat overlapping to follow the sun's path to an optimum

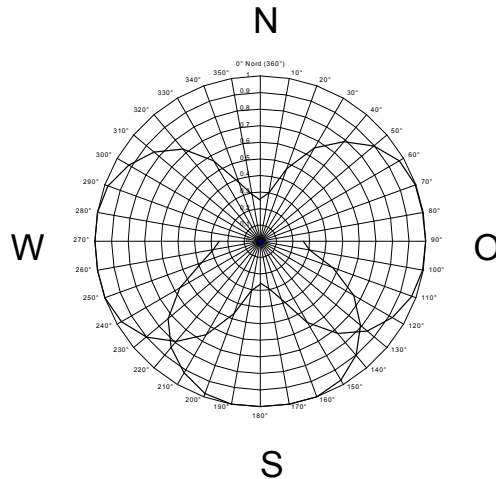

Their pre-configured measuring ranges cover 0 ... 110,000 lux. The value 0 lux will be issued in case the measured values below 1000 lux.

To display the current illuminance the measured value can be sent at a selectable difference from the previous measured value. Sending the values in cycles is also possible.

Two selectable limit values are available where the weather station can send switching telegrams when these values are exceeded or underrun. Such limit values can either be fixed internally or set externally as variables through a visualization software, for example.

With the exception of the precipitation sensor, the setting of the limit values and of the hystereses is the same for all weather sensors. This procedure is described in detail under "Software Functions – Limit values and hystereses".

The weather station evaluates the three directional brightness sensors (see Chapter "2.2 Twilight") and the twilight sensor of the combination sensor and calculates the greatest sensor value of these four sensors, which can then be transmitted to the bus using the "Measured value, brightness and twilight" communication object, which can be enabled separately. This object can be enabled in the "Combination sensor" parameter branch. Its transmission behaviour can also be configured here.



2.4 Wind speed

To determine the wind intensity the combination sensor has a revolving vane.

Its pre-configured measuring range covers 0 ... 40 m/s. The accuracy < 0.5 m/s is maintained when the outer temperature is kept between -20°C ... +60°C. Lower temperatures may degrade the accuracy somewhat. If, for example, the combination sensor is mounted in the vicinity of an air discharge opening, unfavourable weather conditions might cause an icing up. In this case the weather station can issue a corresponding failure report via the „Error 1 wind sensor (possibly iced up)“ communication object.

To display the current wind speed the measured value can be sent at a selectable difference to the previous measured value. Sending the values in cycles is also possible.

Two selectable limit values are available where the weather station can send switching telegrams when these values are exceeded or underrun. Such limit values can either be fixed internally or set externally as variables through a visualization software, for example.

With the exception of the precipitation sensor, the setting of the limit values and of the hystereses is the same for all weather sensors. This procedure is described in detail under "Software Functions – Limit values and hystereses".

2.5 Precipitation

To detect precipitation (rain, snow, soft hail) the combination sensor has a detector which works with modulated infrared light.

Unlike the other weather sensors, the precipitation sensor does not output any analog measured values but sends a switching telegram with a selectable value immediately after detecting some precipitation.

When the precipitation has ceased, the sensor will still work with a fixed delay of about three minutes. The switch-off delay, which can be parameterized, will be added to the internal delay.

The sensitivity of the rain detection can be set. Within a fixed time period (50 s), the combination sensor calculates the strength of the precipitation by counting the raindrops.

The number of raindrops leading to detection of precipitation is configured using the parameter "Rain detection" in the "Combination sensor - Precipitation" parameter branch, using sensitivity levels. Precipitation is considered as over when, within the fixed time period, no more raindrops are counted and also if the additional switch-off delay has elapsed.



3 Connection with Analog Weather Sensors

If only a part of the combination sensor is used or if additional data are needed, the weather station can be combined with individual sensors which, in each case, convert a quantity into an analog signal.

For some weather sensors, the weather station provides pre-configured settings.

A common alarm object can be activated for all analog inputs of the weather station. This object will be activated if, for example, some overvoltage occurs at an input, or if the connection for the power supply of the measuring sensors is overloaded. With this communication object, the direct error cause cannot be determined.

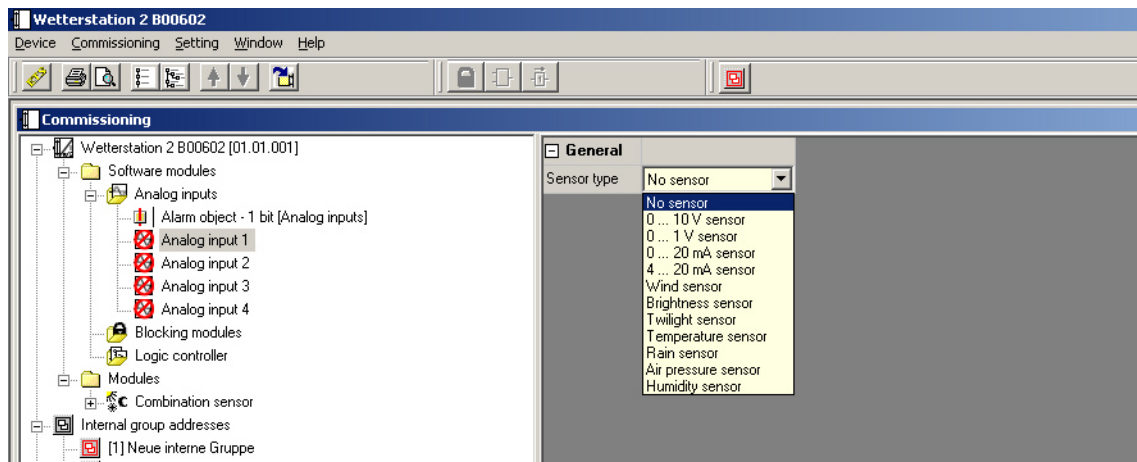

If an analog sensor is to be used, the corresponding channel in the tree structure must be highlighted. The desired sensor type can then be selected from a list.

Sensor

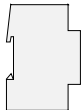

3.1 Wind speed

To determine the wind intensity the wind sensor has a revolving vane which can be heated to protect it from getting iced up. Its setting options correspond to those of the combination sensor.

Its pre-configured measuring range covers 0 ... 40 m/s.

To display the current wind speed the measured value can be sent at a selectable difference to the previous measured value. Sending the values in cycles is also possible.

Two selectable limit values are available where the weather station can send switching telegrams when these values are being exceeded or underrun. Such limit values can either be fixed internally or set externally as variables through a visualization software, for example.

With the exception of the precipitation sensor, the setting of the limit values and of the hystereses is the same for all weather sensors. This procedure is described in detail under "Software Functions – Limit values and hystereses".

3.2 Brightness

The brightness sensor has a detecting element which will be aligned vertically to the building wall when the sensor has been mounted at normal position. In contrast to this, the brightness detectors of the combination sensor are aligned at an angle of about 30° to the horizontal line. For this reason, the individual brightness sensor will normally measure lower illuminance values. Usually, each of these sensors has the same setting options.

Their pre-configured measuring range covers 0 ... 60,000 lux.

To display the current illuminance the measured value can be sent at a selectable difference to the previous measured value. Sending the values in cycles is also possible.

Two selectable limit values are available where the weather station can send switching telegrams when these values are being exceeded or underrun. Such limit values can either be fixed internally or set externally as variables through a visualization software, for example.

With the exception of the precipitation sensor, the setting of the limit values and of the hystereses is the same for all weather sensors. This procedure is described in detail under "Software Functions – Limit values and hystereses".

3.3 Twilight

The twilight sensor has a detecting element which will be aligned vertically to the building wall when the sensor has been mounted at normal position. In contrast to this, the twilight detector of the combination sensor is aligned at an angle of about 30° to the horizontal line. For this reason, the individual twilight sensor will normally measure lower illuminance values. Usually, each of these sensors has the same setting options.

Their pre-configured measuring range covers 0 ... 255 lux.

To display the current illuminance the measured value can be sent at a selectable difference to the previous measured value. Sending the values in cycles is also possible.

Two selectable limit values are available where the weather station can send switching telegrams when these values are being exceeded or underrun. Such limit values can either be fixed internally or set externally as variables through a visualization software, for example.



With the exception of the precipitation sensor, the setting of the limit values and of the hystereses is the same for all weather sensors. This procedure is described in detail under "Software Functions – Limit values and hystereses".

3.4 Temperature

The temperature sensor determines the temperature of the ambient air.

Its pre-configured measuring range covers -30 ... +70 °C.

To display the current temperature the measured value can be sent at a selectable difference to the previous measured value. Sending the values in cycles is also possible.

Two selectable limit values are available where the weather station can send switching telegrams when these values are being exceeded or underrun. Such limit values can either be fixed internally or set externally as variables through a visualization software, for example.

With the exception of the precipitation sensor, the setting of the limit values and of the hystereses is the same for all weather sensors. This procedure is described in detail under "Software Functions – Limit values and hystereses".

3.5 Precipitation

The precipitation sensor works with a conductor meander track which evaluates the conductivity of the rain water.

Unlike the other weather sensors, the precipitation sensor does not output any analog measured values but sends a switching telegram with a selectable value immediately after detecting some precipitation.

3.6 Air humidity

The air humidity sensor determines the relative atmospheric humidity and the room temperature. Both measured values are provided as analog voltages.

Its pre-configured measuring range covers 0 ... 100 % RH.

To display the current relative air humidity the measured value can be sent at a selectable difference to the previous measured value. Sending the values in cycles is also possible.

Two selectable limit values are available where the weather station can send switching telegrams when these values are being exceeded or underrun. Such limit values can either be fixed internally or set externally as variables through a visualization software, for example.

With the exception of the precipitation sensor, the setting of the limit values and of the hystereses is the same for all weather sensors. This procedure is described in detail under "Software Functions – Limit values and hystereses".



3.7 Atmospheric pressure

The pre-configured measuring range of the atmospheric pressure sensor covers 70,000 ... 120,000 Pa.

To display the current atmospheric pressure the measured value can be sent at a selectable difference to the previous measured value. Sending the values in cycles is also possible.

Two selectable limit values are available where the weather station can send switching telegrams when these values are being exceeded or underrun. Such limit values can either be fixed internally or set externally as variables through a visualization software, for example.

With the exception of the precipitation sensor, the setting of the limit values and of the hystereses is the same for all weather sensors. This procedure is described in detail under "Software Functions – Limit values and hystereses".

4 Connection with other Analog Sensors

In addition to the pre-configured weather sensors, other measuring sensors providing output signals of 0 ... 1 V, 0 ... 10 V, 0 ... 20 mA or 4 ... 20 mA can be connected to the weather station.

This sensor type is preset in the same way as the other weather sensors.

4.1 Setting the measuring range

Unlike the pre-configured sensors, the general sensors require presetting of the measuring range.

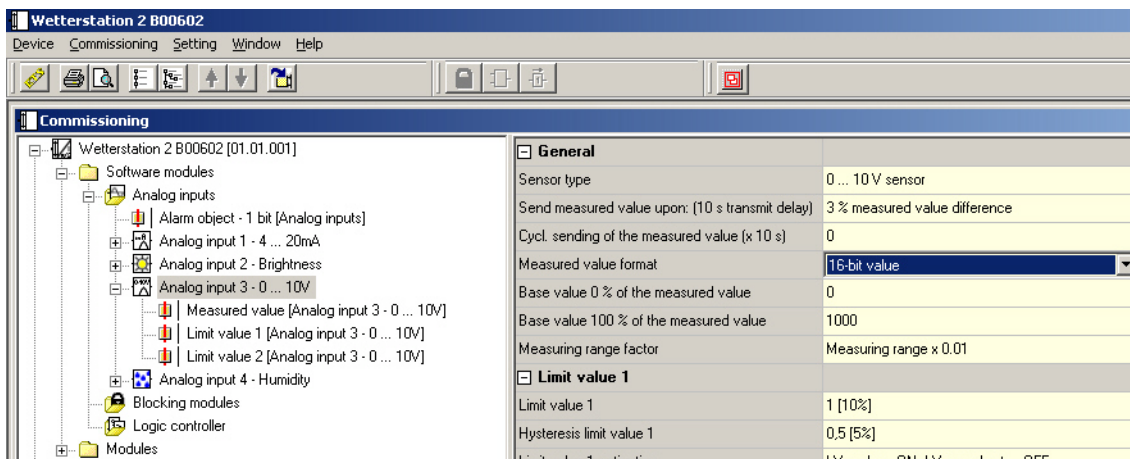



First of all, this includes the decision whether the measured values are to be output in 8-bit or 16-bit form. This choice essentially depends on the other devices which work with such data.

- 8-bit values can be processed by a lot of devices (e. g. dimming actuators or current shutter/blind actuators). However, they have a much restricted resolution.
- 16-bit values are very suitable for display in visualization programs, for example. They have a considerably higher resolution.

Two selectable limit values are available where the weather station can send switching telegrams when these values are being exceeded or underrun. Such limit values can either be fixed internally or set externally as variables through a visualization software, for example.

With the exception of the precipitation sensor, the setting of the limit values and of the hystereses is the same for all sensors. This procedure is described in detail under "Software Functions – Limit values and hystereses".

4.2 Open-circuit monitoring

For sensors which work with an analog signal of 4 ... 20 mA, an open-circuit monitoring option for the electrical connection can be selected in addition.

General	
Sensor type	4 ... 20 mA sensor
Send measured value upon: (10 s transmit delay)	3 % measured value difference
Cycl. sending of the measured value (x 10 s)	0
Measured value format	16-bit value
Base value 0 % of the measured value	400
Base value 100 % of the measured value	2000
Measuring range factor	Measuring range x 0.01
Limit value 1	
Limit value 1	7,2 [20%]
Hysteresis limit value 1	0,8 [5%]
Limit value 1 activation	LV under = ON, LV over+hyst. = OFF
External limit value 1	No
Switch-on delay limit value 1	3 min delay
Switch-off delay limit value 1	10 min delay
Send limit value 1 in case of a change of value	Yes
cycl. sending of limit value 1 (x 10s)	0
Limit value 2	
Open circuit	
Open-circuit monitoring	Yes
Output	No open circuit = 0, open circuit = 1

If open-circuit monitoring is activated an additional 1-bit communication object is created which will send a telegram with a selectable value in the event of a fault.



5 Software Functions

The weather station has a number of software functions used for all sensor inputs in the same way, or which can be used within the entire building installation, regardless what method of measured-value acquisition is applied.

The functions used for all sensors in the same way concern measured-value conditioning as well as setting the limit values and hystereses.

Those functions which can be used as independent software modules are blocking elements and logic gates.

5.1 Measured-value conditioning

What settings of the measuring ranges are necessary or possible depends on the type of the sensor used.

For the pre-defined weather sensors, the data point types of the communication objects are fixed in accordance with the KNX standard. Any further alteration of these measuring ranges will not be possible.

Sensor	Range	Unit	Data point type
Brightness – combination sensor	0 ... 110,000	Lux	9.004
Brightness – analog input	0 ... 60,000	Lux	9.004
Twilight – combination sensor	0 ... 674	Lux	9.004
Twilight – analog input	0 ... 255	Lux	9.004
Wind	0 ... 40	m/s	9.005
Temperature	-30 ... +70	°C	9.001
Air humidity	0 ... 100	%	9.007
Atmospheric pressure	70,000 ... 120,000	Pa	9.006

For the general analog sensors, the measured values of the analog sensors can be output either in 16-bit or in 8-bit form

5.1.1 16-bit measured-value output

When 16-bit values are used, the parameters "Base value 0 % of the measured value", "Base value 100 % of the measured value" and "Measuring range factor" will be available.

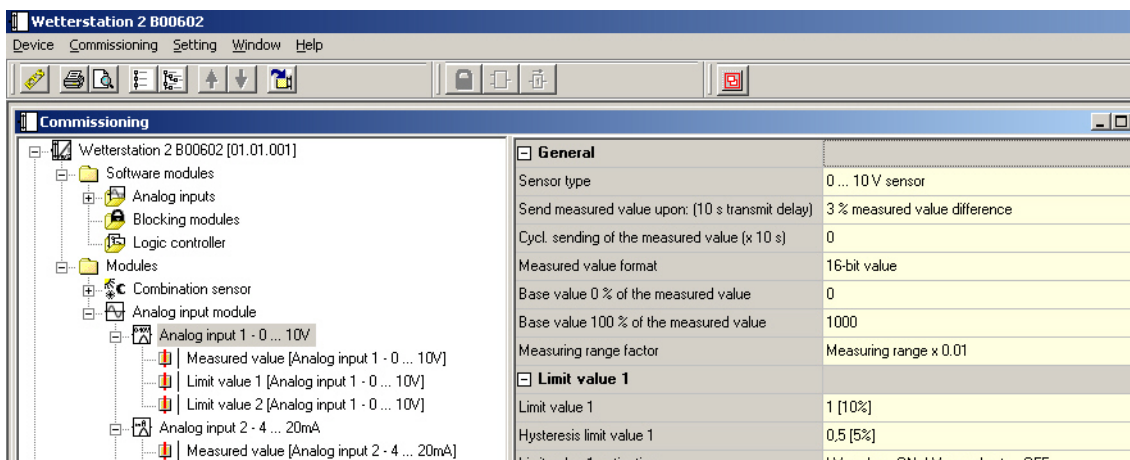

In this connection, both base values must be selected so that they cover the measuring range of the sensor sufficiently by their common factor.



To obtain maximum possible resolution, the smallest possible factor should be chosen. On the other hand, the resolution should not be so as to suggest an unrealistic precision as, for instance, a room temperature with two places after the decimal point.

Example:

A pressure transmitter has a measuring range of -50 Pa ... +150 Pa.

Its output signal is 0 ... 10 V.

The combination of

base value 0 % of the measured value:	-5000
base value 100 % of the measured value:	+15000
measuring range factor	0.01

will cover the range of -50,00 Pa ... +150,00 Pa with two places after the decimal point.

The combination of

base value 0 % of the measured value:	-50
base value 100 % of the measured value:	+150.
measuring range factor	1

will cover the range of -50 Pa ... +150 Pa without any places after the decimal point.

For connections with other devices, it should be noted that only the numerical values will be transmitted in the telegrams on the bus. The physical quantities and their units are defined in the KNX standard and will have to be uniformly set in the devices.

5.1.2 8-bit measured-value output

If 8-bit values are used, the parameters "Base value 0 % of the measured value" and "Base value 100 % of the measured value" will be available.

The screenshot shows the 'Commissioning' window for a device named 'Wetterstation 2 B00602'. The left pane shows a tree view of the device's configuration, including 'Analog input 1 - 0 ... 10V'. The right pane shows the configuration for this input, with the following settings:

General	
Sensor type	0 ... 10 V sensor
Send measured value upon: (10 s transmit delay)	3 % measured value difference
Cycl. sending of the measured value (x 10 s)	0
Measured value format	8-bit value
Base value 0 % of the measured value	0
Base value 100 % of the measured value	255
Limit value 1	
Limit value 1	25.5 [10%]
Hysteresis limit value 1	12.75 [5%]
Limit value 1 activation	LV under = ON, LV over+hyst. = OFF
External limit value 1	No

If the measured values are to be output in 8-bit form an output value between 0 and 255 for the minimum and maximum values can be entered in each case. However, the minimum output value must be lower than the maximum output value.

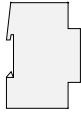

5.2 Limit values and hystereses

The weather station has two limits for each analog value. For each value, a hystereses can be set and the response defined when the values are exceeded or underrun.

In the following dialog, such values can be set either by sliders or in numerical form. In this connection, the "Overview" box will show a graphical representation of the response selected with reference to the currently defined measuring range.

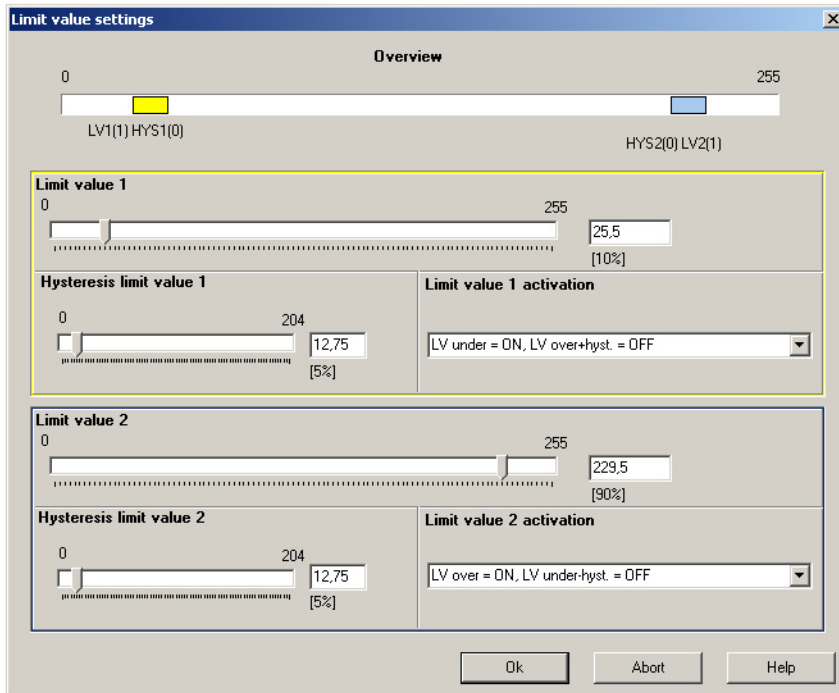



When setting the limit value or the hystereses with the sliders, the software prevents leaving the limits of the measuring range. However, the two limit values or the hystereses may reach the right or left limits of the setting ranges. If this should happen it will not be possible to go below the limit on the left or exceed the limit on the right.

Example:

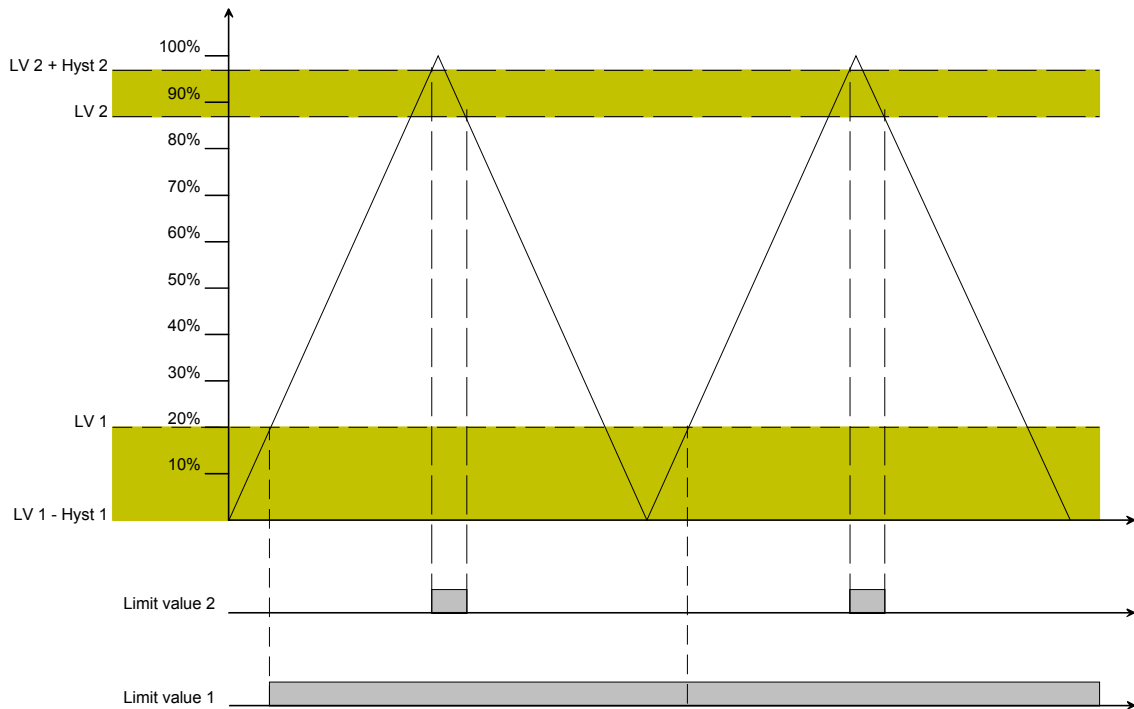

In this example, limit value 2 has a sufficient distance to the maximum value of the measuring range. However, for limit value 1 the hysteresis is getting into contact with the minimum value of the 0 % measuring range. In this case, the object value needs to be changed not more than once. Then it will remain constant.

5.3 External limit values

5.3.1 Value presetting

If the limit values are to remain adjustable while the building installation is in operation the "External limit value ..." communication objects can be enabled. These communication objects are capable of processing either 1-byte or 2-byte values and can, for example, be connected with external push sensors to act as value transmitters..

The information in the "Limit value settings" dialog can serve as clues for the parameterization of such value transmitters. In this connection, the setting range should be restricted in such a way that a 1 % safety distance to each range limit will remain.

Important

Any external value will overwrite the internal one. The original internal value will only be re-activated after a new application download by the ETS. Reading out the object values will only be correct if some value has been written into the objects via the bus at least once after a reset.

instabus KNX/EIB System

Sensor



5.3.2 Teach-In function

If the user is to have the option of using the current measured value as the new limit value without knowing the numerical value itself, the „External limit value...” parameter can be set to “Save limit value via switching object (Teach-In)”. As soon as this „Save limit value...(Teach-In)” object receives a telegram with the value „1”, the weather station will accept the last measured value as the new limit value. Telegrams with the value “0” will be ignored.

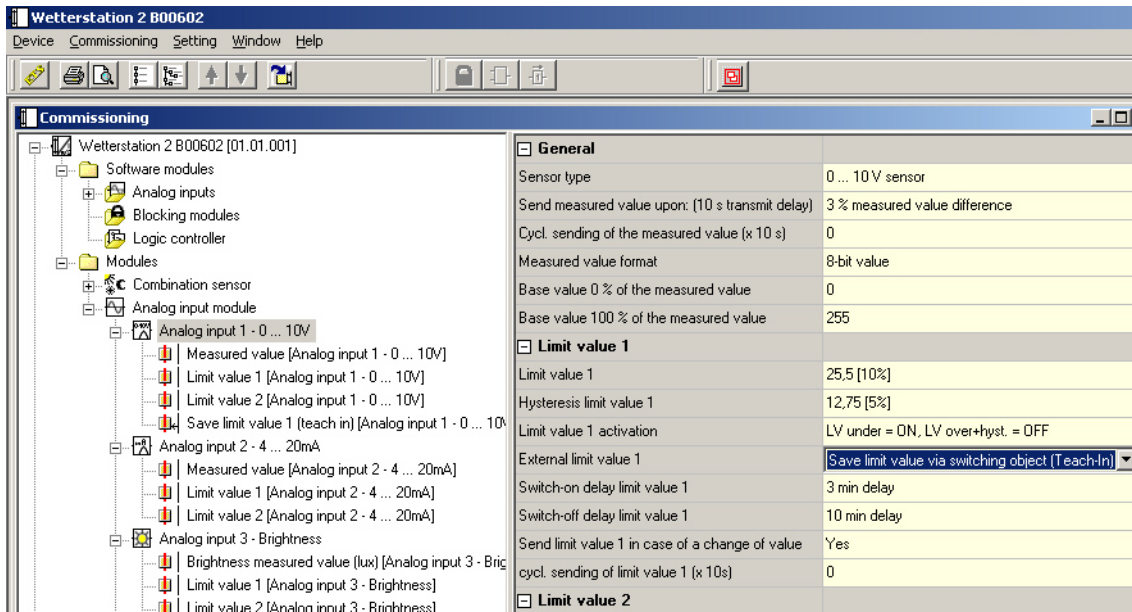

In case the Teach-In function is triggered by a touch sensor, this touch sensor should be parameterized such that it will only transmit the value „1” after a long key-press.

The Teach-In function is not available for the wind sensor of the combination sensor and for the analog wind sensor.

Caution

An external value will overwrite the internal value. The internal value will be reactivated only after a new application download via the ETS. A read-out of the object values will provide exact values only if the objects have been written at least once via the bus following a reset.



5.4 Blocking modules

The device software has up to 16 blocking modules, the actually useful number depending on the configuration of the device, since a maximum of 200 communication objects are available for the whole device.

To be able to use a blocking module select the "Software modules -> Blocking modules" option in the tree structure shown in the configuration window. Here, a new blocking module can be added.

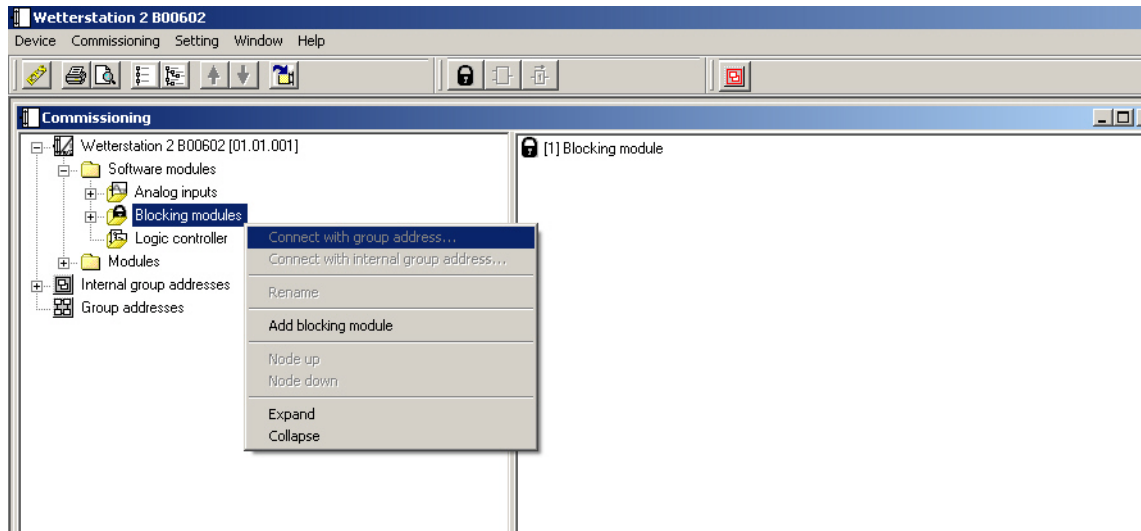

Blocking modules consist of an input object, an output object and of a blocking object. In the device software they act like a lock. Depending on the value of the blocking object, the value of the input object will be passed on to the output object in unchanged form, or be blocked.

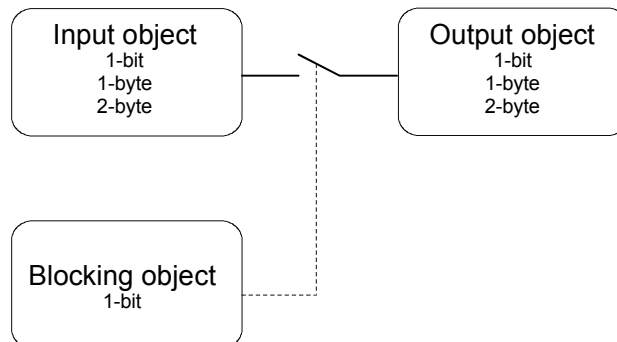

The blocking object is a 1-bit communication object, its behaviour (block at 0, block at 1) and its status being selectable upon initialization.

If the value of the input is being changed during a blocking period the output will send this value once the blocking is being cancelled.

In the configuration, a name can be assigned to each blocking module. Such name will then be used in the three communication objects as a part of the object name. This helps to improve documentation and also will make easier further configuration work.



5.5 Logic controller

The device software has up to 20 logic controllers, the actually useful number depending on the configuration of the device, since a maximum of 200 communication objects are available for the whole device.

To be able to use a logic gate select the "Software modules -> Logic controller" option in the tree structure shown in the configuration window. Here, a new logic gate can be added. After selecting a gate, further inputs can be added. Each gate can have up to eight inputs.

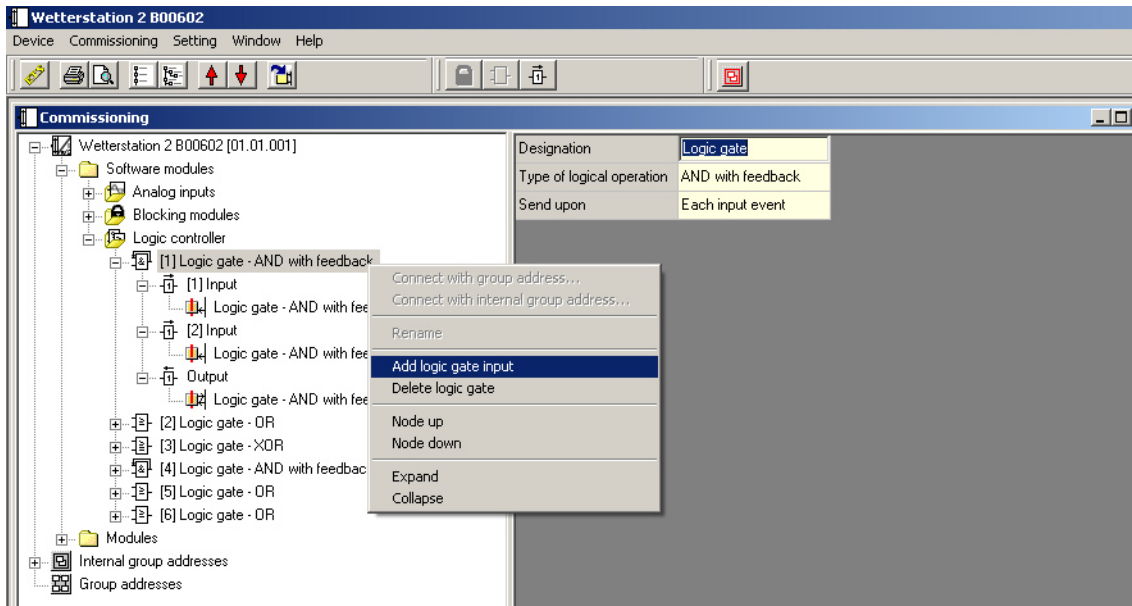

For each logic gate, the type of logic operation (AND, OR, exclusive OR) which will then also be shown in the tree structure can be set. In addition, each input and the output can be used in its normal or in inverted form.

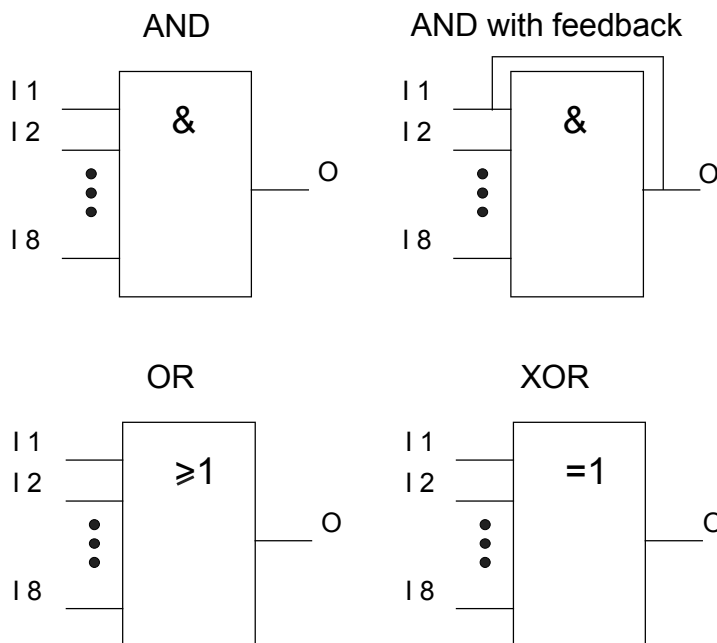

In case of „AND with feedback“ the input value will be internally returned to input 1. This will have the effect that the output will receive the value „1“ only if input 1 is set to „1“ after all other inputs also have the value „1“. As soon as one of the other inputs receive the value „0“, the output and thus also the input 1 will be set to „0“.



An example of an application of this kind of logic function is a luminous source which is to be switched on only after dusk. In this case the pushbutton will be connected with the input 1 and the limit value of the twilight sensor will be connected with input 2.

After the twilight sensor has set the input 2 to „1“ it will be possible to switch on the light at input 1 with the pushbutton. In case the light has not been accidentally switched off manually by accident, the feedback will make sure at dawn that input 1 will be internally reset to „0“. Without this feedback the light would be automatically switched on again at dusk.

Thus, the following combinations will result for three inputs with or without an inverted output:

Inputs			Outputs						
1	2	3	AND	OR	Excl.-OR	AND Feedback	NAND	NOR	Non-excl.-OR
0	0	0	0	0	0	0	1	1	1
0	0	1	0	1	1	0	1	0	0
0	1	0	0	1	1	0	1	0	0
0	1	1	0	1	0	0	1	0	1
1	0	0	0	1	1	0 *)	1	0	0
1	0	1	0	1	0	0 *)	1	0	1
1	1	0	0	1	0	0 *)	1	0	1
1	1	1	1	1	1	1	0	0	0

*) Input 1 will be automatically reset again to „0“.

The transmitting behaviour of the gate/output can be influenced in different ways:

- Having been set to "Output change", the "Transmit upon" parameter of the gate will allow for a reduction of the bus load. If the result of the logic operation is, for example, time-monitored in a shutter/blind actuator it may make sense that the output sends a telegram upon each input event.
- Switch-on delay/switch-off delay: No telegram/delay ON/no delay. The two parameters "Switch-on delay" or "Switch-off delay" of the gate output can block or delay output telegrams having the value of "1" or "0" (no telegram). In such case, the "Base" and "Factor" parameters will be shown. The delay times will be restarted by new input telegrams.
- By the "Output cyclic sending (x 10 s)" parameter, the output can repeat the telegrams at regular intervals, even though their values do not change. Basic setting "0" of this parameter means that the output will not repeat the telegrams. A maximum cycle time of 20 minutes (120 x 10 s) can be preset.

instabus KNX/EIB System

Sensor



For more complex functions, several logic gates can be combined. If this should result in any feedback effects, i. e. connection of an output with an input of the same gate (possibly also through other logic gates or blocking modules) it will not be prevented by the configuration software. The other device functions will not be disturbed thereby. As such feedbacks can lead to a huge number of telegrams, appropriate switch-on or switch-off delays should be set in this case.

Normally, a logic operation will only be evaluated upon the reception of an incoming telegram. If there is a feedback with a cyclically sending output it may happen that the device will send telegrams on its own after the application has been loaded, or after a reset. Especially in such case, switch-on or switch-off delays will make sense.

Note on the use of delays at the output of a logic function:

When using the delays (switch-on delay / run-on-time) it must be noted that the run-on-times can be retriggered. Thus for the switch-on delay a "1" telegram at a gate input causes the delay time to be restarted over and over again. A "0" state at a gate output retriggers the run-on time again each time. Consequently, input states are only evaluated and output states are transmitted to the bus as a telegram only once the time delays have elapsed completely.

It is particularly important to consider this if input states are transmitted cyclically to the gate! For a combination of cyclic transmission and delays, the delay times must always be set smaller than the times for the cyclic transmission.

5.6 Group addresses/internal group addresses

When being started, the plug-in takes all the currently defined group addresses from the ETS and shows them in the tree structure. In addition, the plug-in can use "internal group addresses" which are not sent to the bus. From the shortcut menu, internal group addresses can be created.

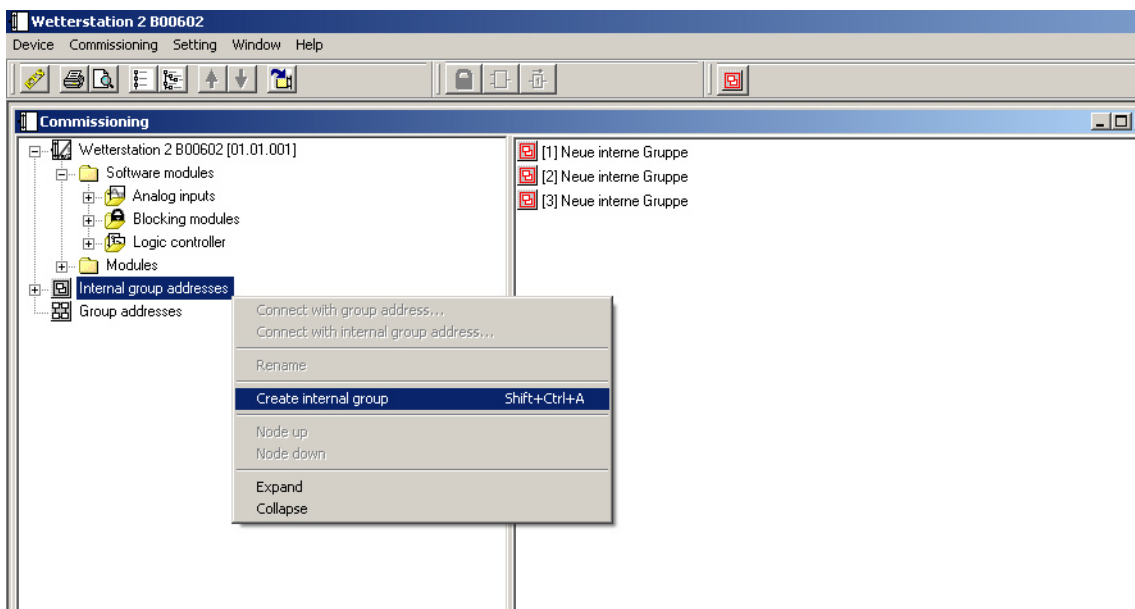



Group addresses and internal group addresses can be connected with the communication objects in the same way by "drag and drop" using the mouse, or from the shortcut menu. If want to create a connection is to be created from the shortcut menu, a dialog box will open where a group address can be entered.

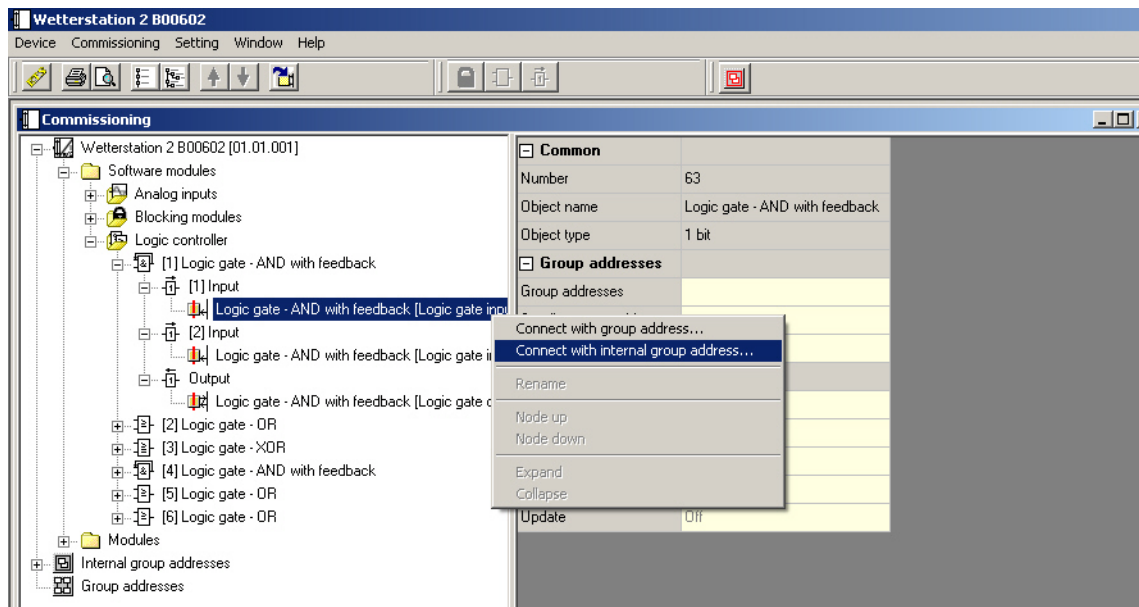

The use of internal group addresses will make sense if, for example, it is intended to combine two limit values into a logic operation, with only the result of such operation being processed by a different device.

6 Automatic Shading

Shading control with automatic readjustment of the shutter/blind slats or elevation offers the optimized utilization of the natural daylight, avoiding extreme dazzling at the same time.

The automatic shading control function is based on the calculated position of the sun which, for the human observer, moves from East over South to West during the course of the day. In this connection, the path of the sun is very flat in winter and very steep in summer.

Also, information on the building is required.

Automatic readjustment of the shutter/blind slats will only be possible in connection with the DCF-reception combination sensor.

The shutter/blind actuators must facilitate slat positioning through a 1-byte communication object. The control of the shutter/blind elevation is also possible via 1-byte communication objects whereby the 1-byte objects are somewhat easier to use.



6.1 Calculating the sun position

The weather station calculates the position of the sun from the geographical position of the building as well as from the current time and the current date.

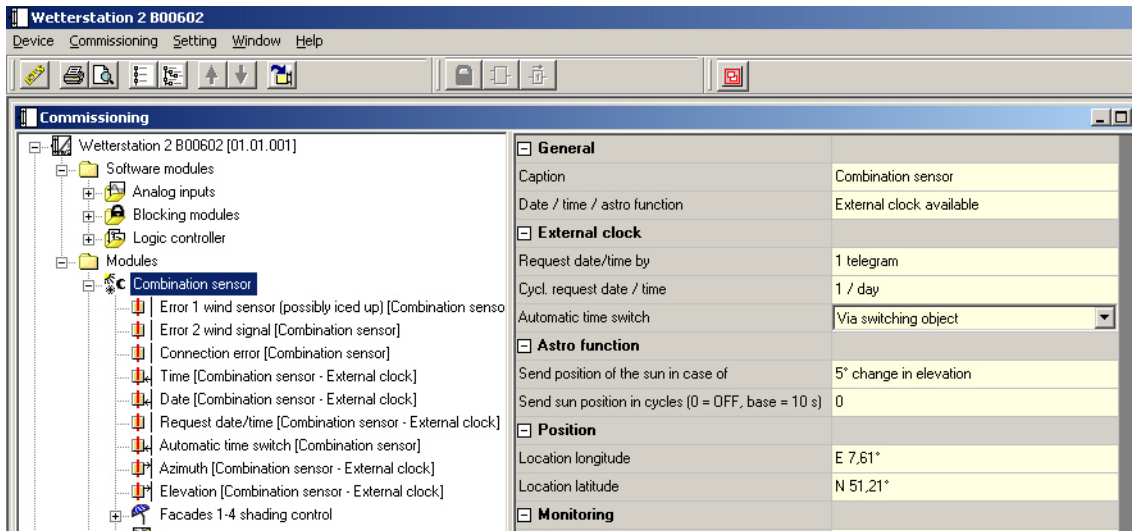

The geographical position can be entered within the framework of the configuration work. For this purpose, either the exact coordinates of the building are available, or a neighbouring German town or city can be selected from the list. To get the correct time the weather station uses the DCF77 receiver of the combination sensor. From these values, the weather station can calculate the correct sun position.

Steep path of the sun in summer.

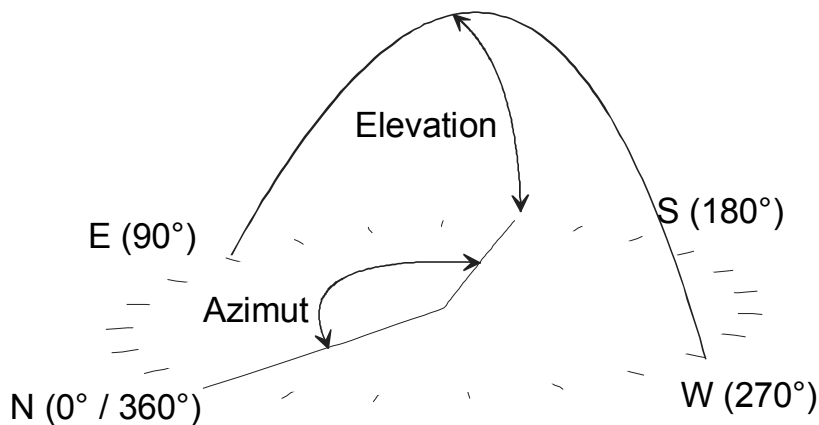



Flat path of the sun in winter.

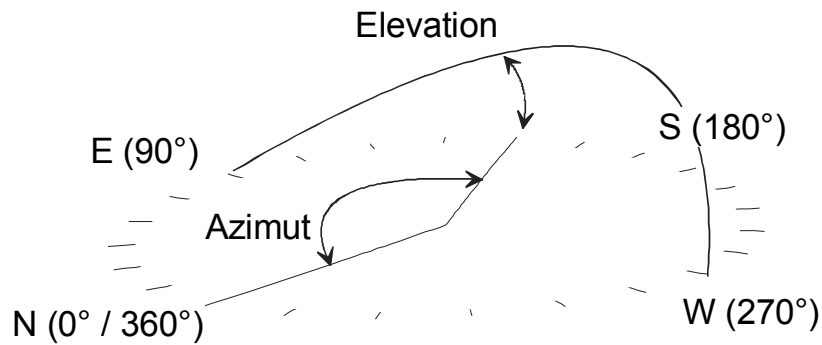

From the viewpoint of the observer, the sun's position is described by two angles. The azimuth defines the angle between the geographical north direction and a vertical circle through the centre of the sun. The elevation (sun height) defines the angle between the horizon and the sun's centre.

The following figure depicts the sun's position during the course of a day on different days of the year at the example of Stuttgart.

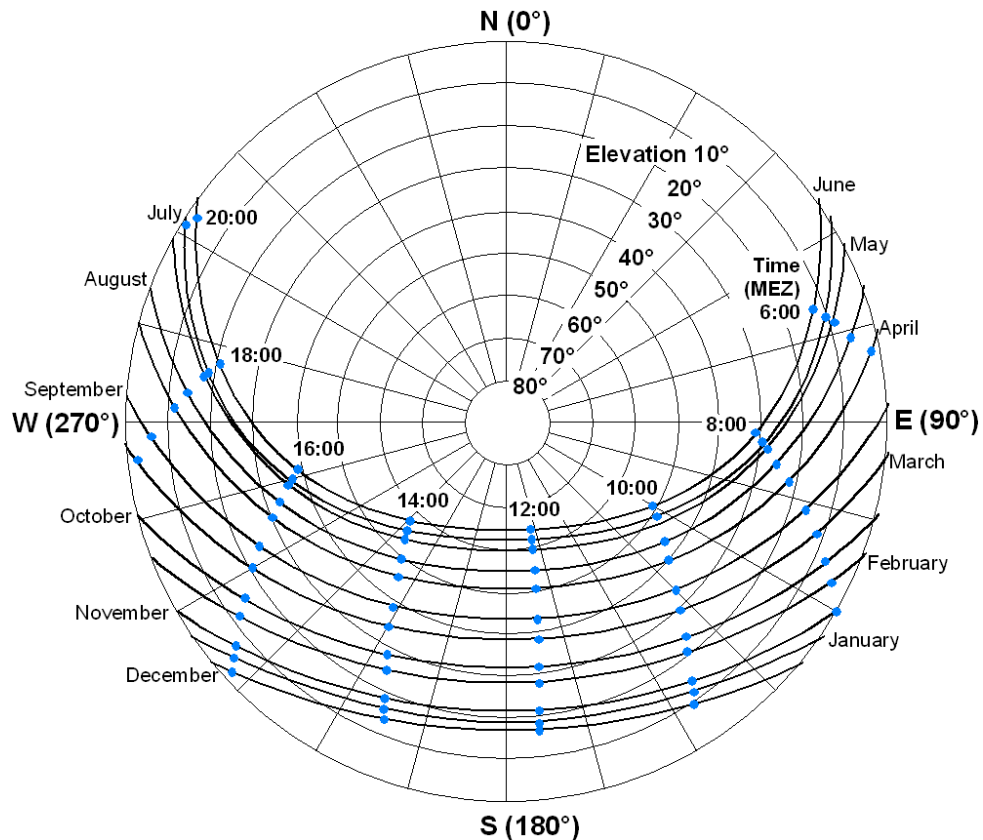



6.2 Building orientation

The automatic shading control starts at the moment when at least one of the three brightness sensors indicates that the illuminance has exceeded the selectable threshold.

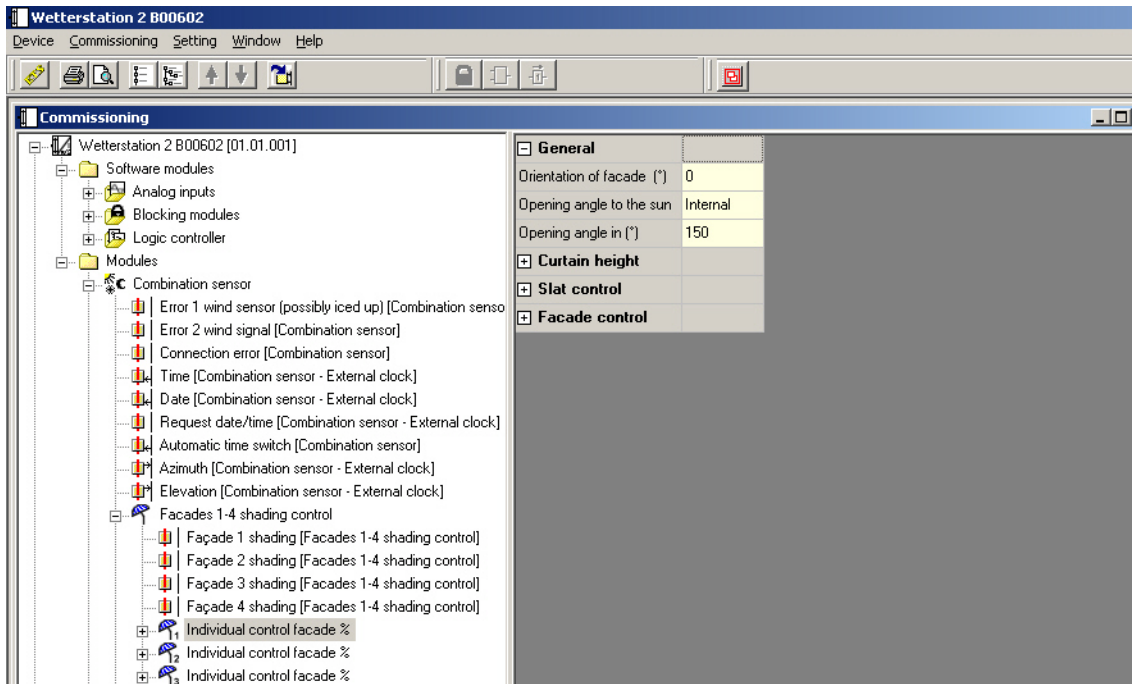

To enable the weather station to determine for which of the up to four façades of the building shading is necessary the orientation and the opening angle are still required for each façade.

Example:

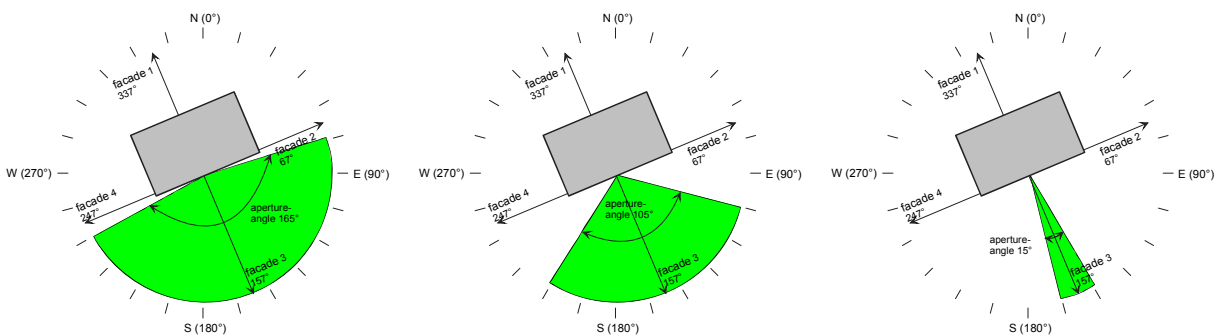

The orientation of the façades are determined by the direction of a vertical line projected onto each façade. Such orientation data can, for example, be obtained from the construction documents.

The opening angle determines in what range the sun azimuth must be so that disturbing dazzling can occur. Entering a value of 180° means, that as soon as the sun just begins to shine through the windows of this façade, the shutters/blinds of this façade will be moved down. If an opening angle of 1° has been entered, the azimuth must virtually be vertical to the façade. It is possible either to set a fixed opening angle, or to vary it in operation by an external value transmitter. In such case, the external opening angle will overwrite the parameterized value.



6.3 Shutter/blind control

As already described in the previous sections, the weather station will send a 1-bit telegram with the value of "1" for each façade if the brightness threshold has been exceeded and the sun azimuth is within the opening angle of the façade. .

The "Façade ... shading" communication object is depending on the selected parameter either a 1-bit object with is connected with the „Long-time operation“ objects of the shutter/blind actuators for this Façade or it is a 1-byte telegram which is connected with the „Shutter/blind positioning“ objects.

Thus, the shutters/blinds of this façade can be moved down. To enable all shutter/blind drives to really reach their bottom end position the slats will be positioned only after some waiting time. If the shading works with 1-byte objects, there will be no preset waiting time because the actuators will save the position of the slats internally and because they can track after the shutter/blind was moved down.

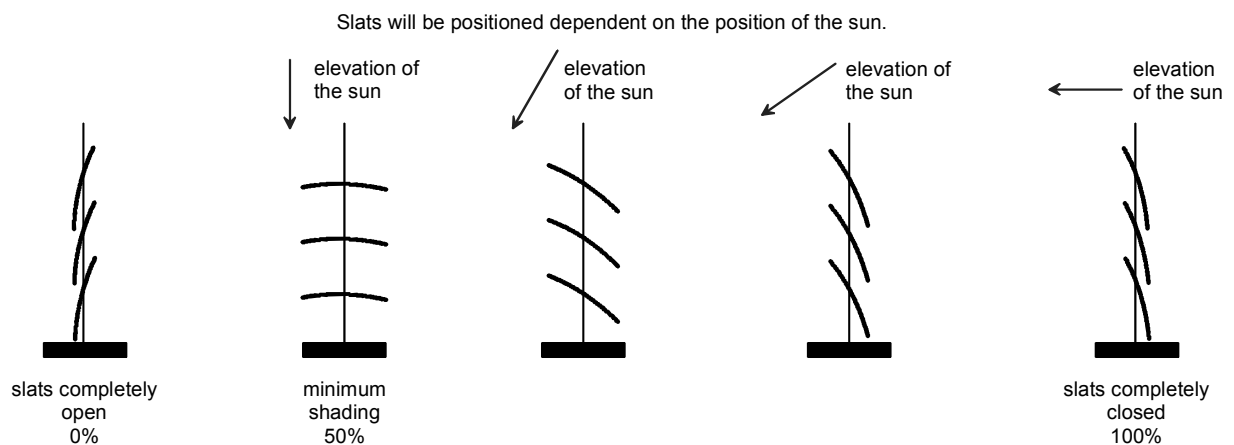

The positioning of the slats depends on the elevation of the sun. To obtain optimum protection from dazzling the slats must be adjusted vertically to the falling sunlight. The calculation of the slat position can be carried out with percentage values acc. to the following formula:

$$\text{Slatposition} [\%] = \text{Elevation} \cdot \frac{\text{Min} - \text{Max}}{90} + \text{Max} + \text{Offset}$$

Min and *Max* are the slat positions in percent for minimum and maximum shading. In addition, it is possible to enter an offset to adapt to different slat curtains.

As long as the sun radiation is above the parameterized "Basic brightness for shading" value, the slat positioning telegrams will be sent in cycles. For most of the shutters/blinds, slat readjustment is effected by short-time moving of the slat curtain. This is normally in connection with a clearly audible jerk. For this reason, the slat positioning cycle time should not be selected too short.

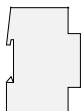

6.4 Control of the curtain height

In addition to the automatic tracking of the slats that provides shading depending on the sun's position, the weather station is also able to adapt the curtain height in steps to the elevation angle of the sun. This allows for a gradual shading with roller blinds and awnings that do not feature a slat adjustment. Just like the slat control the curtain height control of a Façade is only active, if at least one of the three brightness sensors (East, South, West) registers that the brightness has exceeded the value for the basic brightness for the shading and if the sun's azimuth lies within the opening angle of the Façade.

The weather station offers three thresholds for each Façade, which can be individually activated. Whenever one threshold is activated, another parameter becomes visible, which can be used to define the threshold value of the sun's elevation. The elevation values of the thresholds must be defined in increasing order.

If the used actuators allow to preset the curtain height via 1-byte objects, the „Type of curtain height“ parameter should be set to „1-byte value“. If the actuators instead are able to call up parameterizable values for the curtain height via switching objects, it is possible to set the parameter to „1-bit switching“:

- If the „type of curtain height object“ parameter of the Façade is set to „1-byte value“, the weather station provides the „Façade ...shading curtain height threshold/position“ 1-byte object for this Façade. It is possible to define the percentage value of the height position for each activated threshold, if this threshold is exceeded. The weather station will send the value 100% for a value below threshold 1.
- If the „type of curtain height object“ parameter of the Façade is set to „1-byte switching“, the weather station will provide a „Façade ...shading curtain height threshold/position ...“ 1-bit object for this Façade for each active threshold value. If a threshold has been exceeded, the corresponding object will send the value „1“. The position have to be parameterized in the actuators. If required, the priorities of these 1-bit objects will have to be adjusted in the actuators.

In case the shading of a Façade has ended because the brightness has fallen below the basic brightness or the because the azimuth has left the opening angle of the Façade, the 1-bit curtain height objects will be set to „0“ or the 1-byte curtain height object set to 0%..

The following table demonstrates the connection between the elevation, the threshold values and the transmitted object values for the curtain height:

Elevation and thresholds		Shutter/blind elevation object 1-Byte	Shutter/blind elevation object: 1-Bit		
			threshold 3	threshold 2	threshold 1
	El. ≤ thr.1	100 %	0	0	0
	thr.1 ≤ El. < thr.2	X %	0	0	1
	thr.2 ≤ El. < thr.3	Y %	0	1	1
	thr.3 ≤ El.	Z %	1	1	1



6.5 Blocking the shading for each Façade

The automatic shading for each Façade can be individually blocked and enabled via a switching object, if the „Block Façade shading“ parameter is set to „Yes“. In this case the „Block façade shading...“ 1-bit object as well as other parameter will be shown.

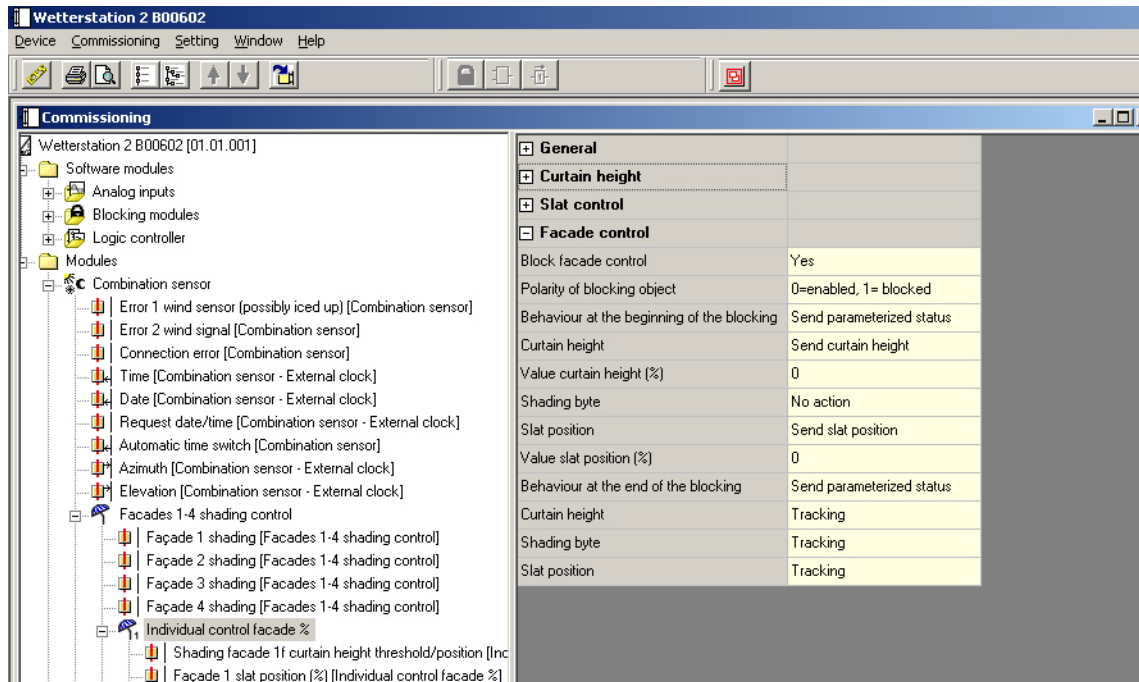

The „Polarity of blocking object“ parameter determines the object value that will block or enable the shading.

The other parameter define the behaviour of the different communication objects when switching from an enabled state to a blocked state and vice versa.

No shading objects, no slat position objects and no curtain height objects will be send during a blocking. The response to the blocking (transition from „not blocked“ to „blocked“) and unblocking (transition from „blocked“ to „not blocked“) has to be set via parameter. The shading, curtain height and slat position objects will be send again at the next event after the end of a blocking (periodical transmission or change of value). In case „tracking“ has been parameterized for the response at the end of a blocking, the objects will be immediately updated.

Independent of the parameterized polarity of the blocking objects, no Façade will be blocked after a reset of the weather station. As long as there are no valid time and date values (DCF77 or external clock) the shading values will be set to „0“ even in case of blocked Façades.



7 Protection of Awnings and Outer Blinds

Awnings and externally installed blinds are endangered by the weather conditions. Normally, two aspects are taken into consideration in this connection.

1. Excessively high winds could damage the curtains.
2. When the curtains are wet they could freeze under frost conditions. So they could get damaged during the next positioning event.

Under what weather conditions an external blind or an awning can get damaged depends on its design and on its proper installation. Detailed information can be obtained from their respective manufacturers.

7.1 Wind speed

The wind speed is normally defined in metres per second or in kilometres per hour. Since 1806, a classification of wind force levels established by Sir Francis Beaufort is existing. For this reason, the unit of wind intensity has been named after him. The unit is abbreviated as "bft".

The following table provides an overview of the different wind force levels:

bft	m/s	km/h	Name of wind	Description
0	0,0 ... 0,4	0,0 ... 1,8	Calm	Calm; smoke rises vertically.
1	0,5 ... 2,0	1,9 ... 7,3	Light Air	Direction of wind shown by smoke drift, but not by wind vanes.
2	2,1 ... 3,5	7,4 ... 12,9	Light Breeze	Wind felt on face; leaves rustle; ordinary vanes moved by wind.
3	3,6 ... 5,6	13,0 ... 20,3	Gentle Breeze	Leaves and small twigs in constant motion; wind extends light flag.
4	5,7 ... 8,1	20,4 ... 29,5	Moderate Breeze	Raises dust and loose paper; small branches are moved.
5	8,2 ... 11,2	29,6 ... 40,6	Fresh Breeze	Small trees in leaf begin to sway; crested wavelets form on inland waters.
6	11,3 ... 14,3	40,7 ... 51,8	Strong Breeze	Large branches in motion; whistling heard in telegraph wires; umbrellas used with difficulty.
7	14,4 ... 17,4	51,9 ... 63,8	Near Gale	Whole trees in motion; inconvenience felt when walking against the wind.
8	17,5 ... 21,0	63,9 ... 75,8	Gale	Breaks twigs off trees; generally impedes progress.
9	21,1 ... 24,6	75,9 ... 88,8	Severe Gale	Slight structural damage occurs (chimney-pots and slates removed).
10	24,7 ... 28,7	88,9 ... 103,6	Storm	Seldom experienced inland; trees uprooted; considerable structural damage occurs.
11	28,8 ... 32,8	103,7 ... 118,4	Violent Storm	Very rarely experienced; accompanied by wide-spread damage
12	More than 32.9	More than 118.5	Hurricane	Massive and widespread damage to structures.

To monitor the wind, the weather station can be used either in connection with a separate wind sensor or with the combination sensor. For large buildings or nested ground plans, it may make sense to combine several sensors since the same wind speed will possibly not occur in all places.



In addition to pure wind speed measurements, the combination sensor offers the advantage that the weather station will be enabled to monitor the connection with the combination sensor and to check the information from the latter for plausibility.

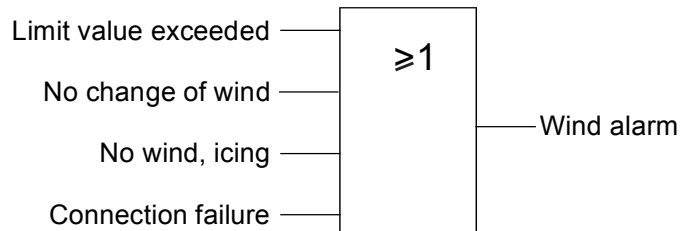

The result of this internal logic OR operation can now be connected to the safety communication objects of the corresponding shutter/blind actuators.

7.2 Frost protection

To protect awnings, external blinds or other frost-sensitive curtains from icing up, two influence quantities must be considered.

Curtains at risk should be drawn in when the temperature drops below about 3 °C and when precipitation occurs. Even if the precipitation stops, the risk of icing up will only be over when the temperature climbs above the limit value.

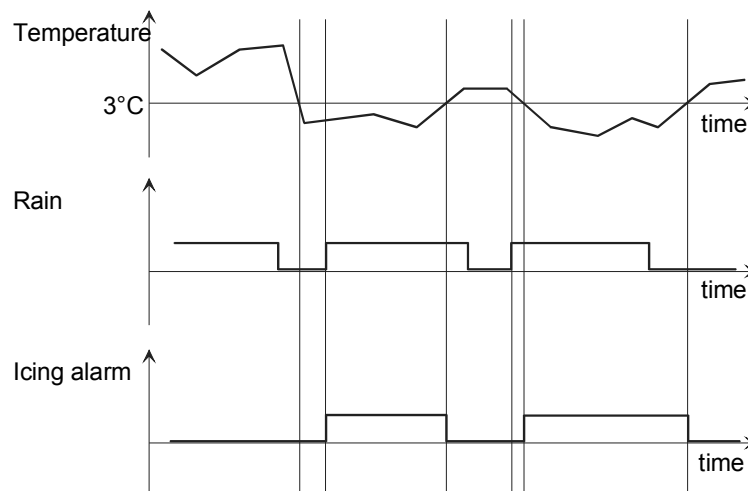

Sensor

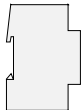

To accomplish this task, two logic gates can be combined in the following way:

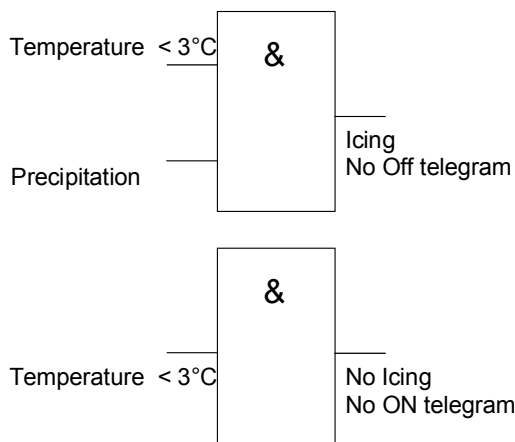

- The first gate is a logic AND operation of the two signals "Temperature below 3 °C" and "Precipitation". In this connection, set the output so that it will send the switch-on telegram, thus setting the alarm status. If the rain ceases, the curtains should, however, not be moved out before the temperature is again above 3 °C. For this reason, the output of the first gate will send a no switch-off telegram.
- The second gate serves to stop the alarm. It only has one input and does not send any switch-on telegrams.

The temperature limit can be monitored by a temperature sensor connected to an analog input. A temperature variation of say 2 Kelvin (corresponding to 2 % for the pre-configured temperature sensor) should be used as hysteresis. The precipitation can be monitored either by the rain sensor of the combination sensor device or by a separate rain sensor connected to an analog input. Unless the two pieces of information "Temperature < 3 °C" and "Precipitation" are used by other devices, the connections with the inputs of the gates can be established as "internal group addresses".

7.3 Note on parameter configuration of logic gates for awning and external shutter protection

Limiting values that affect a logic gate as an input signal for awning and external shutter protection may not be transmitted cyclically if a switch-on delay or run-on time is configured at the gate output. If it is necessary in the KNX/EIB system to also transmit the limiting values used for the awning and external shutter protection cyclically to the bus, then two additional logic gates have to be enabled in the ETS. These additional gates (OR, 1 input) must then have the limiting values assigned to them separately from each other on the input side, and the output state must be transmitted cyclically to the bus. Optionally, switch-on delays and run-on times can be configured here.



8 Getting Started

The weather station can be programmed via the ETS with the installed plug-in.

8.1 Initialization/status indications

After the first start, the weather station will run a module scan (status LED: "orange/ON"). Since a new device does not include any configuration by default the status LED will then change to "red/ quickly blinking".

A combination sensor which has not yet been logged into the weather station will indicate readiness for operation by two short tones recurring every 5 s. In this state, the combination sensor can already be logged in and the antenna aligned (refer to the combination sensor Operating Instructions).

After loading a project into the weather station the status LED will change to "green/ON". The extension module will switch off its status LED.

8.2 Plug-in options

The weather station can be configured by means of a plug-in to be called from the ETS. This plug-in provides various options.

8.2.1 Table

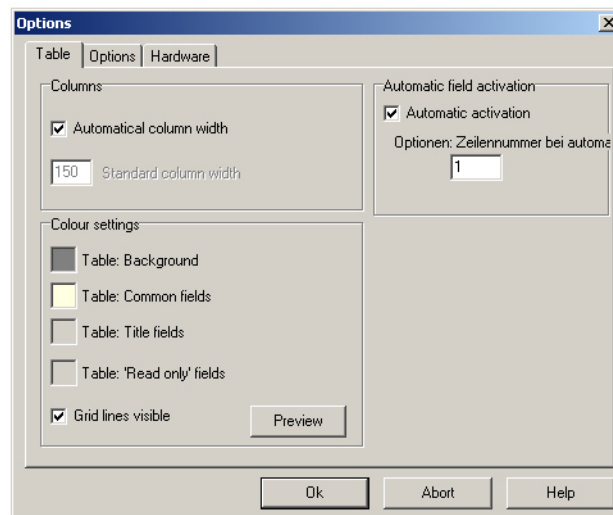

On the "Table" tab, various options concerning the appearance of the tables on the right of the window can be set. These can be changed in acc. with personal requirements.

instabus KNX/EIB System

Sensor



8.2.2 Options

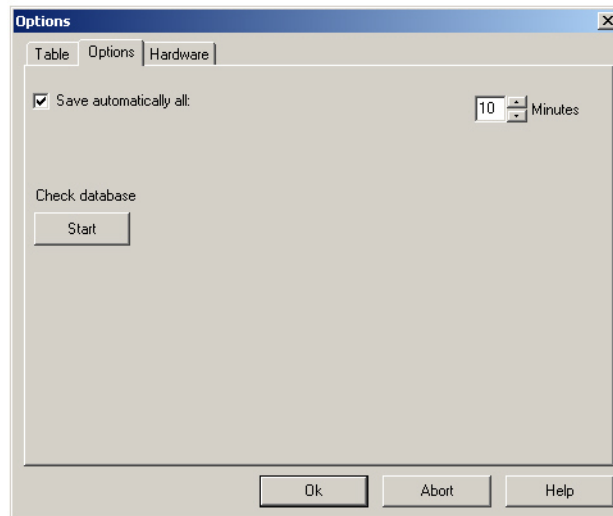

The "Options" tab can be used to specify at what intervals the plug-in is to save changed data. In addition, the saved data can be checked for internal conflicts or other errors.

8.2.3 Hardware

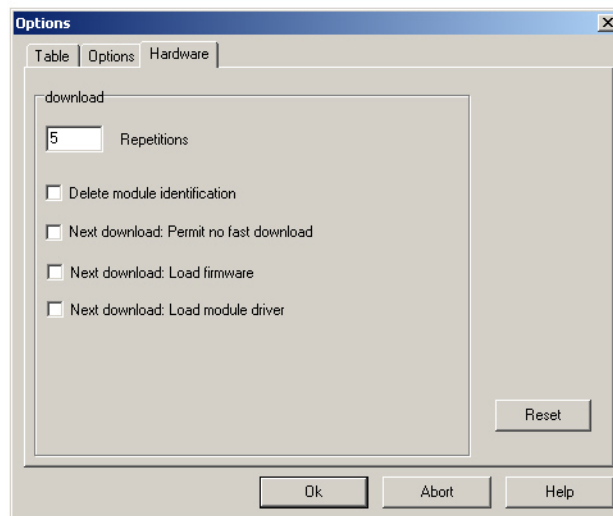

The "Hardware" tab can be used to set four different options which will come into effect when the application software is being loaded into the weather station. In principle, it should not become necessary to activate these options. If any problems should occur during the start-up they can possibly be solved by the following options.

**Deleting a module ID:**

If the weather station works in conjunction with a digital combination sensor it must be logged into the weather station one single time by means of the programming magnet. By this procedure, the combination sensor will tell the weather station its unambiguous module ID. If a defective combination sensor has to be replaced by a new device, the module ID of the previous sensor will be overwritten by the ID of the new one when the latter is being logged in. After activating this option, the combination sensor must be logged in once again.

No fast download:

During the start-up, the PC will first determine what data have been currently loaded into the weather station. To keep the programming time as short as possible, only the changed data will then be transferred. By means of this option, the entire application without any optimization will be loaded. This will possibly prolong the start-up time considerably.

Firmware download/module driver download:

These two software components are always downloaded into the devices at their manufacturing stage. Within the scope of a later version of the plug-in, later versions will possibly be provided. In such case, the start-up software should automatically recognize that a different version has been downloaded into the device and issue a corresponding message. If these two options are actuated manually, the two software components will be downloaded into the device again. This will considerably prolong the start-up time.



9 Using the weather station in combination with different actuators

On the one hand the configuration of the weather station depends on the required function scope. On the other hand it depends on the actuators that are being used. The following descriptions include recommendations for typical applications.

9.1 Simple sun protection with shutter/blind actuator

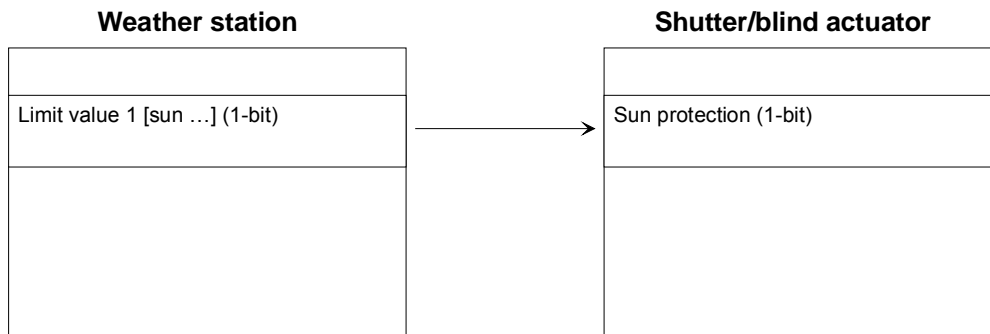

In case the limit value for brightness has been exceeded, the weather station will transmit a telegram with the value „1“ via the „Limit value 1 [sun]“ object.

That will activate the sun protection in the shutter/blind actuator and set the appropriate fixed sun position protection for curtain and slat. When the value falls below the limit value for the measured brightness (if needed with hystereses and time delay) the weather station will transmit the value „0“. That will deactivate the sun protection and set the appropriate position at the end of the sun protection.

The priority of the sun protection in comparison to the direct operation can be adjusted according to the desired mode (higher/equal/lower).

9.2 Simple sun protection with blind/shutter actuator

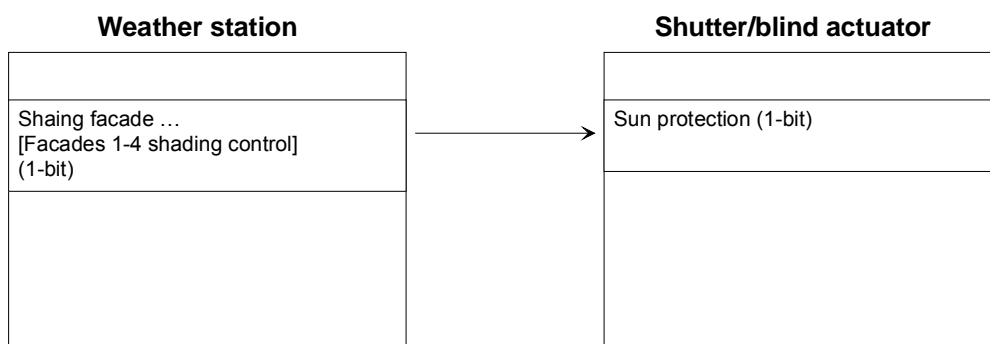

In case the limit value for brightness has been exceeded, the weather station will transmit a telegram with the value „1“ via the „Façade shading [Façades 1-4 shading control]“ object.

That will activate the sun protection in the shutter/blind actuator and set the appropriate fixed sun position protection for curtain and slat. When the value falls below the limit value for the measured brightness (if needed with hystereses and time delay) the weather station will transmit the value „0“. That will deactivate the sun protection and set the appropriate position at the end of the sun protection.



The priority of the sun protection in comparison to the direct operation can be adjusted according to the desired mode (higher/equal/lower).

9.3 Sun protection with fixed curtain height and slat tracking in the shutter/blind actuator

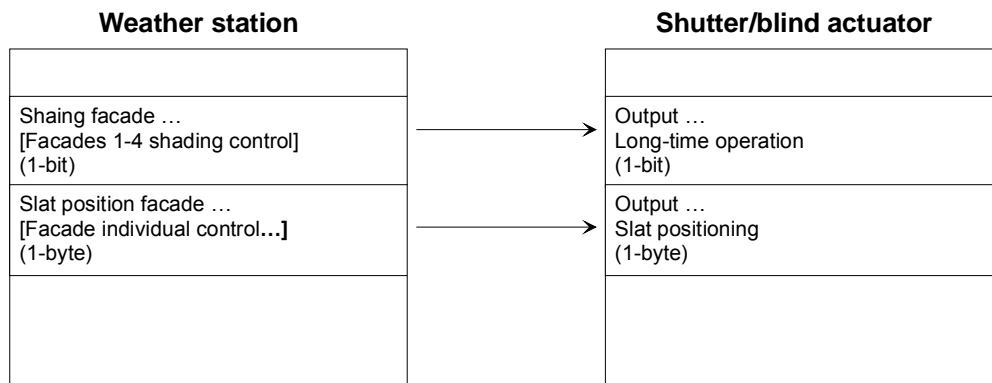

In case the limit value for brightness has been exceeded, the weather station will transmit a telegram with the value „1“ via the „Façade shading [Façades 1-4 shading control]“ object. This will move the curtain of the shutter/blind actuator into the lower final position.

After the waiting time parameterized in the weather station has lapsed, the positioning commands will be send for the slats. The actuator will adjust the corresponding slat position (position of curtain will remain unchanged).

At the end of the shading the curtain of the shutter/blind actuator will be moved into the top final position via the „Façade shading [Façades 1-4 shading control]“ object with the value „0“.

Note:

For configuration of parameters and objects, the individual instructions of the technical documentation for the shutter actuator being activated must be taken into account.

9.4 Sun protection with fixed curtain height and slat tracking in the shutter/blind actuator

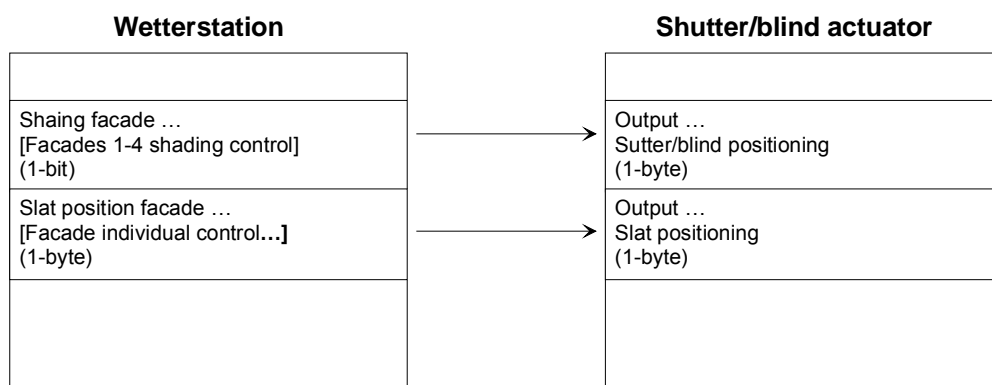

instabus KNX/EIB System

Sensor



In case the limit value for brightness has been exceeded, the weather station will transmit a telegram with the value „1“ via the „Façade shading [Façades 1-4 shading control]“ object. This will move the curtain of the shutter/blind actuator into the lower final position.

After the waiting time parameterized in the weather station has lapsed, the positioning commands will be send for the slats. The actuator will adjust the corresponding slat position (position of curtain will remain unchanged).

At the end of the shading the curtain of the shutter/blind actuator will be moved into the top final position via the „[Façade shading [Façades 1-4 shading control]“ object with the value „0%“ and the „Façade slat position [Façade individual control...]“ object with the value „0%“.

Note:

For configuration of parameters and objects, the individual instructions of the technical documentation for the shutter actuator being activated must be taken into account.

9.5 Sun protection with variable curtain height and slat tracking in the shutter/blind actuator

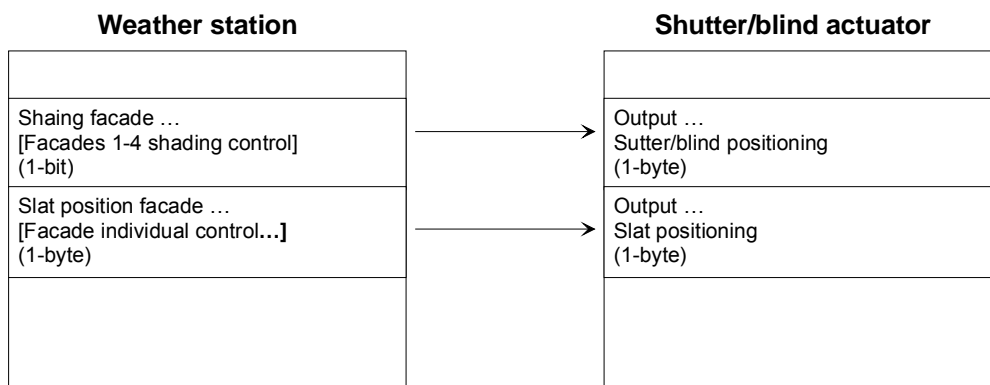

The weather station will transmit a telegram with the parameterized curtain height via the „Façade shading curtain height [Façades 1-4 shading control]“ object in case the basic brightness for shading has been exceeded and in case the parameterized sun position angle. This will move the curtain of the shutter/blind actuator into the appropriate position.

Next, the positioning commands for the slats will be send. The actuator will adjust the corresponding slat position (curtain position will remain unchanged).

At the end of the shading the curtain of the shutter/blind actuator will be moved into the top final position via the „[Façades 1-4 shading control]“ object with the value „0%“ and the „Façade slat position “[Façade individual control...]“ object with the value „0%“.

Caution

For this application the control determining whether the operation of the shutter/blind takes place directly or automatically must take place by means of a logic gate in the weather station. Also, at the end of the shading the curtain position = „0%“ as well as the slat position = „0“ must be transmitted in order to move the curtain into the top final position.



9.6 Simple sun protection with shutter/blind actuator order no. 1039 00

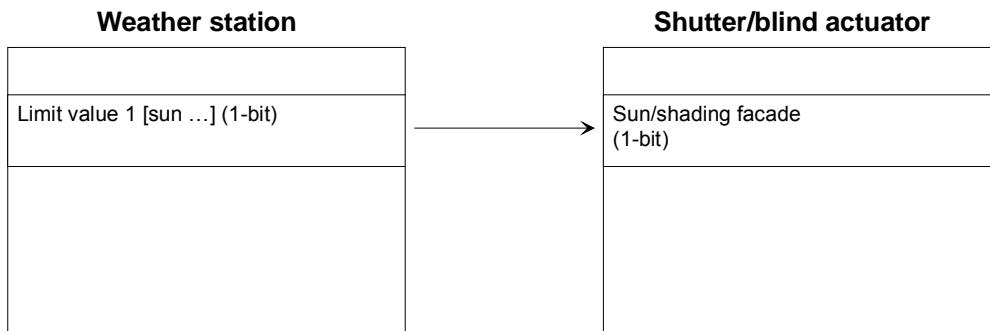

The weather station will transmit a telegram with the value „1“ via the „Limit value 1 [sun ...]“ object, if the limit value (for brightness) has been exceeded. This will activate the sun protection in the blind/shutter actuator and adjust the appropriate fixed sun protection position for curtain and slat.

When the value falls below the limit value for the measured brightness (if required with hystereses), the weather station will transmit the value “0”. This will deactivate the sun protection in the shutter/blind actuator and adjust the appropriate position at the end of the sun protection.

Note:

The priority of the sun protection for direct operation can be adjusted in the shutter/blind actuator as follows:

- Simple sun protection parameterization :
 - „Priority“ parameter (higher/equal/lower) between sun protection mode and direct operation
- Extended sun protection parameterization:
 - „Automatic“ datapoint for activating the automatic operation (0=no automatic / 1= automatic)
 - „Automatic blocking“ datapoints and „Blocking direct operation“ for blocking and enabling the operating modes (high priority)
 - „Priority“ parameter (higher/equal/lower) between automatic operation and direct operation (lower priority)

9.7 Simple sun protection with shutter/blind actuator order no. 1039 00

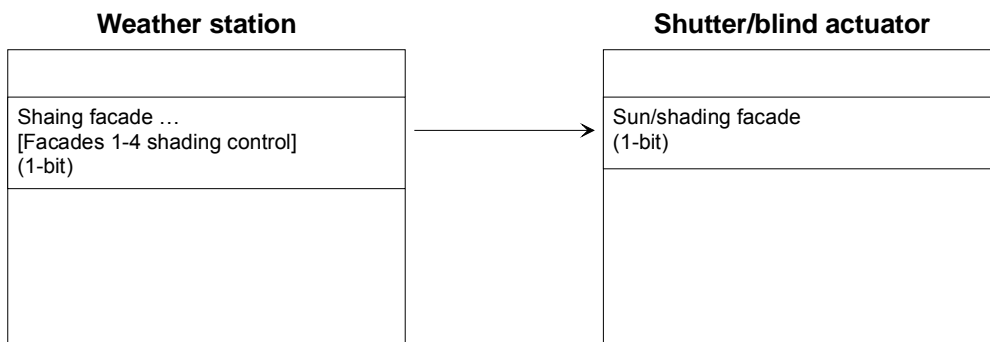

The weather station will transmit a telegram with the value “1” via the „Façade shading [Façades 1-4 shading control]“ object in case the basic brightness for shading has been exceeded. This will activate the sun protection and adjust the appropriate fixed sun protection position for curtain and slat.

instabus KNX/EIB System

Sensor



If the value has fallen below the basic brightness value for shading (if required with hystereses) the weather station will transmit the value „0“. This will deactivate the sun protection mode in the shutter/blind actuator and adjust the appropriate position at the end of the sun protection.

Note: The priority of the sun protection for direct operation can be adjusted in the shutter/blind actuator as follows:

- Simple sun protection parameterization:
 - „Priority“ parameter (higher/equal/lower) between sun protection and direct operation
- Extended sun protection parameterization:
 - „Automatic“ datapoints for activating the automatic operation (0=no automatic / 1=automatic)
 - „Automatic blocking“ datapoints and „Blocking direct operation“ for blocking and enabling the operating modes (high priority)
 - „Priority“ parameter (higher/equal/lower) between automatic operation and direct operation (lower priority)

The blocking mode may not be used in the weather station for shading control – the automatic operation in the shutter/blind actuator itself can, for example, be blocked individually for each channel via the „Blocking the automatic“ objects.

9.8 Sun protection with fixed curtain height and slat tracking in shutter/blind actuator order no. 1039 00

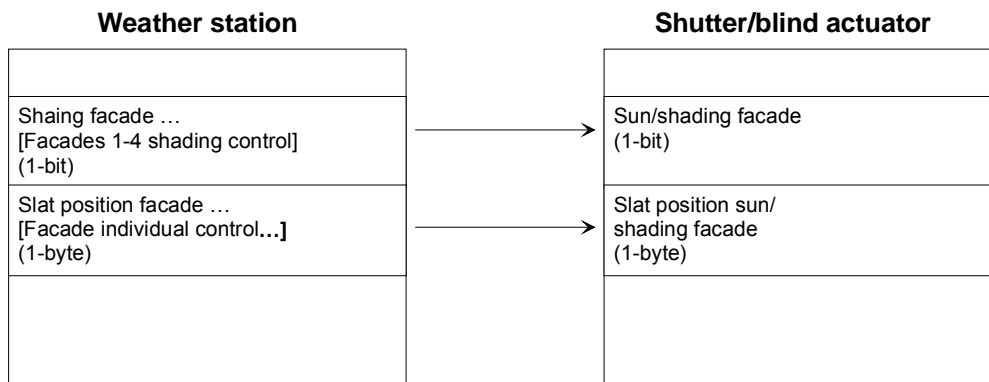

The weather station will transmit a telegram with the value „1“ via the „Façade shading [Façades 1-4 shading control] object as well as the slat position to be adjusted for the slat tracking, if the basic brightness value for shading has been exceeded. This will activate the sun protection in the shutter/blind actuator, thus adjusting the appropriate sun protection position for the curtain and finally the received slat position for the slat tracking.

The weather station will transmit the value „0“ via the „Façade shading [Façades 1-4 shading control]“ object in case the basic brightness for shading (if required with hystereses) has been exceeded. This will deactivate the sun protection in the shutter/blind actuator and adjust the appropriate fixed position for the curtain and slat at the end of the sun protection.

The shutter/blind actuator will adjust the „Façade slat position [Facade individual control...“ telegram transmitted with the value „0%“ by the weather station at the end of the shading, if the value has been received and processed before the object = “0” was received.



After “Façade shading [Façade 1-4 shading control]“ = „0“ has been received, the parameterized positions for curtain and slat will be adjusted at the end of the sun protection or a possible position run in progress for curtain and slat will be continued to the end without change in case of “Response at the end of sun/shading“ = „no response “ (it will be moved to the parameterized curtain height in case of an existing shading or this position is kept and, in addition, moved into the opened slat position „0%).

Ideally, the „Façade slat position [Façade individual control ...]“ = „0%“ telegram will be suppressed per parameter in the weather station at the end of the shading (characterized by the „Façade shading [Façade 1-4 Façade control]“ = „0“ telegram). This can prevent the following effects in the shutter/blind actuator:

- If ‘Response at the end of sun/shading—no response’ is set in the shutter/blind actuator, the slat position will always be adjusted to the value 0% in case of ‘No response’ at the end of the shading (in case of the behaviour underlined above).
- In case of the other settings in the shutter/blind actuator (Response at the end of sun/shading—starting up, shutting down, moving to a fixed position etc.) (no stopping), the mentioned behaviour at the end of the sun protection might cause the shutter/blind to jerk (in case of the behaviour underlined above).

Note:

The priority of the sun protection for the direct operation can be adjusted in the shutter/blind actuator as follows:

- Simple sun protection parameterization:
 - „Priority“ parameter (higher/equal/lower) between sun protection operation and direct operation
- Extended sun protection:
 - „Automatic“ datapoint for activating the automatic operation (0=no automatic / 1=automatic)
 - „Blocking automatic“ datapoints and „Blocking direct operation“ for blocking and enabling the operating modes (high priority)
 - „Priority“ parameter (higher/equal/lower) between automatic operation and direct operation (lower priority)

The blocking function in the weather station may not be used to control the shading – the automatic operation in the shutter/blind actuator itself may be blocked individually for each channel, for example, via the „Blocking automatic“ objects.

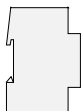

9.9 Sun protection with variable curtain height and slat tracking in the shutter/blind actuator order no. 1039 00

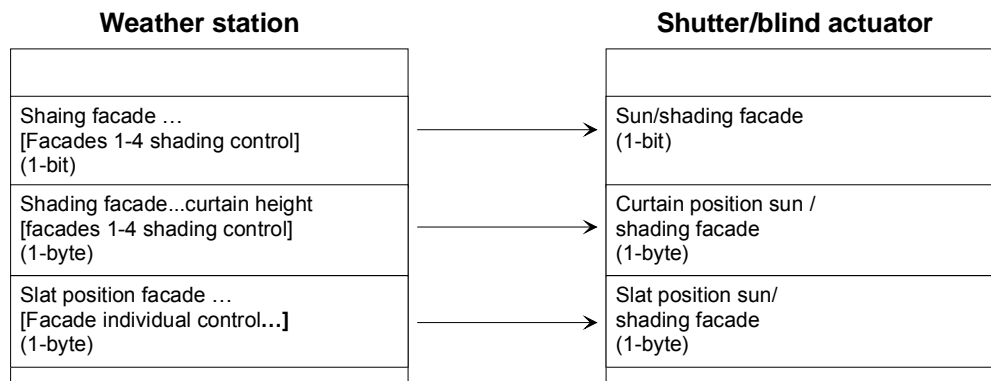

If the basic brightness value for shading is exceeded, the weather station will send a telegram with the value „1“ via the „Façade shading [Façades 1-4 shading control]“ and „Façade shading ... curtain height“ and „Façade slat position“ objects with the curtain height and slat positions to be adjusted. This will activate the sun protection in the shutter/blind actuator adjusting the appropriate curtain height and slat position.

The weather station will transmit the value “0” via the „Façade shading [Façades 1-4 shading control]“ object in case the basic brightness for shading (if required with hystereses) has been exceeded. This will deactivate the sun protection in the shutter/blind actuator and adjust the appropriate fixed position for curtain and slat at the end of the sun protection.

The shutter/blind actuator will adjust the „Façade slat position [Façade shading curtain height [Façades 1-4 shading control]]“ with the value „0%“ and „Façade slat position [Façade individual control...]“ with the value „0%“ send by the weather station at the end of the shading, if the value has been received and processed before the object = “0” was received.

After „Façade shading [Façades 1-4 shading control]“ = „0“ has been received, the parameterized curtain and slat positions will be adjusted at the end of the sun protection or in case of the „Response at the end of sun/shading“ = „no response“ setting a possible positioning in progress for shutter/blind and slat will continue unchanged to the end (it will be moved into the top position = 0% and in the open slat position = 0%).

Ideally, the „Façade slat position „Shading Façade curtain height [Façades 1-4 shading control]“ = „0%“ and „Façade slat position [Façade individual control ...]“ = „0%“ telegrams will be suppressed per parameter in the weather station at the end of the shading (characterized by the „Façade shading [Façade 1-4 Façade control]“ = „0“). This can prevent the following effects in the shutter/blind actuator:

- If ‘Response at the end of sun/shading—no response’ is set in the shutter/blind actuator, the curtain and slat position will always be adjusted in case of ‘no response’ to the value 0% at the end of the shading (in case of the behaviour underlined above).
- In case of the other settings in the shutter/blind actuator (Response at the end of sun/shading—starting up, shutting down, moving to a fixed position etc.) (no stopping), the mentioned behaviour at the end of the sun protection might cause the shutter/blind to buck (in case of the behaviour underlined above).

instabus KNX/EIB System

Sensor

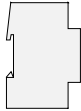

After „Façade shading [Façades 1-4 shading control]“ = „0“ has been received, the parameterized curtain and slat positions will be adjusted at the end of the sun protection or in case of the „Response at the end of sun/shading“ = „no response“ setting a possible positioning in progress for curtain and slat will continue unchanged to the end (it will be moved into the top position = 0% and into the parameterized slat position in case of existing shading).

Ideally, the „Façade shading curtain height [Facades 1-4 shading control]“ = „0%“ telegram will be suppressed per parameter in the weather station at the end of the shading (characterized by the „Façade shading [Façades 1-4 shading control]“ = „0“ telegram). This can prevent the following effects in the shutter/blind actuator:

- If ‘Response at the end of sun/shading—no response’ is set in the shutter/blind actuator, the curtain and slat position will always be adjusted in case of ‘no response’ to the value 0% at the end of the shading (in case of the behaviour underlined above).
- In case of the other settings in the shutter/blind actuator (Response at the end of sun/shading—starting up, shutting down, moving to a fixed position etc.) (no stopping), the mentioned behaviour at the end of the sun protection might cause the shutter/blind to jerk (in case of the behaviour underlined above).



Note: The priority of the sun protection for the direct operation can be adjusted in the shutter/blind actuator as follows:

- Simple sun protection parameterization:
 - „Priority“ parameter (higher/equal/lower) between sun protection operation and direct operation
- Extended sun protection:
 - „Automatic“ datapoint for activating the automatic operation (0=no automatic / 1= automatic)
 - „Blocking automatic“ datapoints and „Blocking direct operation“ for blocking and enabling the operating modes (high priority)
 - „Priority“ parameter (higher/equal/lower) between automatic operation and direct operation (lower priority)

The blocking function in the weather station may not be used to control the shading – the automatic operation in the shutter/blind actuator itself may be blocked individually for each channel, for example, via the „Blocking automatic“ objects.



Sensor

Parameters		
Description	Values	Comment
 Analog inputs software module		
Alarm message	Do not send Send as 1-bit object	If the weather station detects an error at one of the four analog inputs or in the power supply of the measuring sensors an alarm message can be sent. If the parameter has been set to "Send as 1-bit object" the "Alarm object" will be indicated
 Analog inputs/analog input 1 ... 4 software module		
Sensor type	No sensor 0 ... 10 V sensor 0 ... 1 V sensor 0 ... 20 mA sensor 4 ... 20 mA sensor Wind sensor *) Brightness sensor *) Twilight sensor *) Temperature sensor *) Rain sensor *) Atm. pressure sensor *) Air humidity sensor *)	This parameter specifies whether a sensor and what sensor is connected to one of the inputs. For the general sensor types, the format and the scaling of the measured values can be defined afterwards. This is already pre-defined for the weather sensors *).
Send measured value upon 10 s transmit delay)	0.5 % measured-value difference 1% measured-value difference 3% measured-value difference 10% measured-value difference	This parameter specifies at what difference to the previous object value a new measured value will be sent. For a 0 ... 10 V sensor, a measured-value difference of 3 % corresponds to 0.3 V. If the last telegram contained the value of 4 V a new telegram will be sent when the current measured value is below 3.7 V or above 4.3 V.
Cycl. sending of the measured value (x 10 s)	0 ... 120	This parameter specifies the time after which the current measured value will be sent, even though the difference to the previous measured value has not been reached yet. For default setting "0", the measured value will not be sent in cycles.
Sensor type = wind		
Unit	m/s	This unit cannot be changed as the settings for this sensor have been pre-configured.

Sensor



Sensor type = brightness		
Unit	lux	This unit cannot be changed as the settings for this sensor have been pre-configured.
Sensor type = twilight		
Unit	lux	This unit cannot be changed as the settings for this sensor have been pre-configured.
Sensor type = temperature		
Unit	°Celsius	This unit cannot be changed as the settings for this sensor have been pre-configured.
Sensor type = rain		
Output	No precipitation = 0, precipitation = 1 No precipitation = 1, precipitation = 0	Compared with the other weather sensors, the rain sensor provides only two different status messages. This parameter specifies which object value will be sent when it is raining or when it is dry.
Switch-on delay	No delay 1 sec delay 3 sec delay 5 sec delay 10 sec delay 15 sec delay 30 sec delay 1 min delay 3 min delay 5 min delay 10 min delay 15 min delay 30 min delay 6 min delay	The message will be internally relayed only if precipitation still continues to be detected after the adjusted time.
Switch-off delay	No delay 1 sec delay 3 sec delay 5 sec delay 10 sec delay 15 sec delay 30 sec delay 1 min delay 3 min delay 5 min delay 10 min delay 15 min delay 30 min delay 6 min delay	Precipitation is considered to have ceased only if after the approx. 3 minutes of hardware delay and adjusted time no precipitation has been detected.



Sensor

Sending in case of a change of value	Yes No	If the parameter is set to „Yes“ and if a change of value has been determined after the delay time adjusted above, the weather station will send the corresponding telegram.
Cyclic sending (x 10s)	0 ... 120	The cyclic sending takes place independent of the telegrams due to change of values.
Sensor type = atmospheric pressure		
Unit	Pa	This unit cannot be changed as the settings for this sensor have been pre-configured.
Sensor type = air humidity		
Unit	%	This unit cannot be changed as the settings for this sensor have been pre-configured.
Sensor type = 0 ... 10V, 0 ... 1V, 0 ...20 mA, 4 ... 20 mA		
Measured-value format	16-bit value 8-bit value	This parameter specifies the format of the measured values of the analog sensors to be transmitted. The choice depends on what other devices the information is to be further processed in. The "16-bit" choice always offers higher resolution if, for example, the values are to be displayed by a visualization software.
Measured-value format = 16-bit		
Base value 0% of the measured value	-32768 ... (0) ... 32767	With the aid of the three parameters "Base value 0 %", "Base value 100 %" and "Measuring range factor", the weather station can convert the analog input signal to the real measuring range of the measuring sensor used. To obtain a high resolution, the two base values should be set so as to sufficiently cover the measuring range of the sensor with a factor as small as possible.
Base value 100% of the measured value	-32768 ... (1000) ... 32767	
Measuring range factor	Measuring range x 0.01 Measuring range x 0.1 Measuring range x 1 Measuring range x 10 Measuring range x 100	
Measured-value format = 8-bit		
Base value 0% of the measured value	0 ... 255	Using these two parameters, the weather station can convert the analog input signal to the value range of the 1-byte communication object.
Base value 100% of the measured value	0 ... 255	

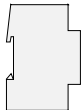



Sensor type = no rain sensor		
Limit value 1, 2	0 ... 100%	<p>With the aid of these three parameters, the thresholds are defined where corresponding switching telegrams will be sent when those thresholds are exceeded or underrun.</p> <p>For these settings, a separate dialog is available where sliders or input fields can be used to define the limit values and hystereses.</p> <p>For better overview, the values set will also be graphically represented.</p>
Limit value 1, 2 hystereses	0 ... 100%	
Limit value 1, 2 activation	<p>LV over = ON, LV hyst. under = OFF</p> <p>LV over = OFF LV hyst. under = ON</p> <p>LV under = ON, LV hyst. over = OFF</p> <p>LV under = OFF, LV hyst. over = ON</p> <p>LV over = ON, LV hyst. under = no telegram</p> <p>LV over = OFF, LV hyst. under = no telegram</p> <p>LV under = ON, LV hyst. over = no telegram</p> <p>LV under = OFF, LV hyst. over = no telegram</p> <p>LV over = no telegram, LV hyst. under = OFF</p> <p>LV over = no telegram, LV hyst. under = ON</p> <p>LV under = no telegram, LV hyst. over = OFF</p> <p>LV under = no telegram, LV hyst. over = ON</p>	
External limit value 1, 2	<p>No</p> <p>16-bit value 8-bit value Save limit value via switching object (Teach-In)</p>	<p>This parameter enables either a 2-byte or a 1-byte object through which the limit value can be changed in operation.</p> <p>When using the 2-byte object or the 1-byte object, the new limit value will be given as an absolute or relative numerical value.</p> <p>When using the Teach-In function, the weather station will accept the current measured value as the new measured value, if the switching object receives the value "1".</p> <p>The Teach-In function is not available in combination with the wind sensor and the rain sensor.</p>



Switch-on delay Limit value 1, 2	No delay 1 s delay 3 s delay 5 s delay 10 s delay 15 s delay 30 s delay 1 min delay 3 min delay 5 min delay 10 min delay 15 min delay 30 min delay 6 min delay	The internal limit value will be set to „1“ only if the condition for activating the limit value is still satisfied after the adjusted time.
Switch-off delay Limit value 1, 2	No delay 1 sec delay 3 sec delay 5 sec delay 10 sec delay 15 sec delay 30 sec delay 1 min delay 3 min delay 5 min delay 10 min delay 15 min delay 30 min delay 6 min delay	The internal limit value will be set to „0“ only if the condition for deactivating the limit value is still satisfied after the adjusted time.
Sending the limit value ... in case of a change of value	Yes No	If the parameter is set to „Yes“ and a change of value has been determined after the delay adjusted above, the weather station will send the corresponding telegram. .
Cyclic sending of the limit value ... (x 10 s)	0 ... 120	The cyclic sending takes place independent of the telegrams due to change of values. There will be no cyclic sending of the telegram, if the presetting = „0“.
Sensor type = 4 ... 20 mA		
Open-circuit monitoring	Yes No	When a 4 ... 20 mA output sensor is in use, this parameter will allow a message to be issued if the electrical connection is interrupted. A 1-bit communication object will then be enabled for this purpose.



 Blocking module		
Name	Blocking module	Enter into your project an internal name, for example, indicating the function of the blocking module. This text will then appear in the tree structure in the left part of the window and in the communication objects in the ETS.
Blocking module response	Blocking upon 1-telegram Blocking upon 0-telegram	This parameter specifies at which value of the blocking object the values of the input will be passed on to the output object.
Blocking response upon initialization	Enabled Disabled	This parameter specifies whether the blocking module will be enabled or disabled upon initialization (voltage recovery, new programming).
Input/output object type	Switching – 1-bit Value – 2-byte Rel. value – 1 byte	This parameter specifies the type of the input and output objects. Both objects will always be of the same type.
 Logic controller		
Name	Logic gate	Enter into your project an internal name, for example, indicating the function of the gate. This text will then appear in the tree structure in the left part of the window.
Type of operation	AND OR Exclusive OR' UND with feedback	This parameter specifies at which value of the blocking object the values of the input will be passed on to the output object.
Transmit upon	each input event change of the output	The parameter specifies whether the logic controller will send a new telegram each time there is a new information at an output or whether it will send a telegram only if the value of the output has been changed.
 Logic controller, input		
Name	Input	Enter into your project an internal name, for example, indicating the function of the input object. This text will then appear in the tree structure in the left part of the window and in the communication objects in the ETS 3.
Input behaviour	Normal Inverted	This parameter specifies whether the value of the input object will be inverted or not before the logic operation.



Logic controller, Output		
Name	Output	Enter into your project an internal name, for example, indicating the function of the output object. This text will then appear in the tree structure in the left part of the window and in the communication objects in the ETS 3.
Output behaviour	Normal Inverted	This parameter specifies whether the value of the output object will be inverted or not before the logic operation.
Switch-on delay	No telegram Delay ON No delay	This parameter can block (no telegram) or delay output telegrams having the value of "1". In this case, the following two parameters will be shown.
Switch-on delay = delay on		
Base switch-on delay	100 ms 1 s 1 min	In conjunction with the following "Factor" parameter, this parameter defines the delay time.
Factor switch-on delay	0 ... 10 ... 100	In conjunction with the previous "Base" parameter, this parameter defines the delay time.
Switch-off delay	No telegram Delay ON No delay	This parameter can block (no telegram) or delay output telegrams having the value of "0". In this case, the following two parameters will be shown.
Switch-off delay = delay on		
Base switch-off delay	100 ms 1 s 1 min	In conjunction with the following "Factor" parameter, this parameter defines the delay time.
Factor switch-off delay	0 ... 10 ... 100	In conjunction with the previous "Base" parameter, this parameter defines the delay time.
Output cyclic sending (x 10 s)	0 ... 120	This parameter specifies whether and how often the output telegrams will be send in cycles.



 Combination sensor		
Name	Combination sensor	No selectable parameter.
Date / time / astro function	disabled Internal clock (DCF77 reception) enabled External clock enabled	If a combination sensor with a built-in DCF77 receiver is used, this parameter can be set to "Internal clock". In addition to the transmission of the time, this will facilitate the calculation of the current sun position, thus automatically readjusting shutter/blind slats to provide shading. If the synchronization of the internal clock takes place via different bus device, please select "External clock enabled". In this case the automatic sun position dependent control of the shading is also possible. If a combination sensor which has no DCF77 receiver is used, please set this parameter to "Disabled"
Date / time / astro function = internal clock		
Request date/time via	0 telegram 1 telegram	Even if the time information is general send in cycles, it can be additionally requested at any time. In this case the weather station will wait until the next DCF minute signal to send the time and date. The "time" and "date" communication objects may not set the W flags in order to prevent the transmission of invalid information. The parameter determines the object value used to request date and time.
Cyclic sending date/ time	1/minute 1/hour 1/day	The sending of the DCF time information takes place cyclical with a selectable frequency. If the time information is used to synchronize other bus users, 1 day will usually be sufficient. If the time is to be displayed on a device without its own clock function, the time has to be send every minute.



Date / time / astro function = external clock		
Request date/time via	0 telegram 1 telegram	This parameter specifies by which object value the date and the time are to be requested. This request takes place after reset, return of voltage or after the cycle time of the following parameter.
Request date/time in cycles	1/hour 1/day	This allows to set the frequency of the time/date request. In case of the hourly request, the request telegram will be send during the transition of the internal minutes from 59 to 60. In case of the daily request, the request telegram will be send at the internal time of 04:15. If no date or time telegram has been received within 5 minutes after the sending of the request telegram the „Error internal clock“ object will be sent with the value „1“ – as long as the monitoring of the external clock is parameterized. In this case, a request telegram will be sent every 5 minutes. After the date and time has been received, the object will be reset to the value “0” and the shading control will also be enabled.
Automatic time switch	No Acc. to European standard Via switching object	The external time will still be used to calculate the sun’s position, if set to „No“. The „According to European standard“ setting will automatically reduce the time for the calculation of the sun’s position between the last Sunday in March and the last Sunday in October for the calculation of the external time. If set “Via switching object“, the external time will be reduced for the calculation of the sun’s position after receiving a „1“ via this object. If the object value is “0“, the external time will still be used for the calculation of the sun’s position.



If date / time / astro function = „Internal clock“ or „External clock“		
Send sun's position in case of	1° Change of sun's angle (Elevation) 3° Change of sun's angle (Elevation) 5° Change of sun's angle (Elevation) 10° Change of sun's angle (Elevation) 15° Change of sun's angle (Elevation)	The weather station is able to send the sun's position (azimuth and elevation) depending on the change of the elevation.
Send sun's position in cycles (0= OFF, base 10 s)	0 ... 255	If desired, the weather station can send the current sun position (azimuth and elevation) in cycles. The selectable values of 0 ... 255 correspond to 0 ... 2550 s or 0 ... 42 min.
Location longitude Location latitude	E 7.62° N 51.22°	These two parameters will open a dialog box where the terrestrial position of the building location can be entered. The position can be entered in decimal degrees, in degrees and decimal minutes, or in degrees, minutes and seconds. Alternatively, a place from a list of German towns and cities can be selected.
Connection to combination sensor	Monitor Do not monitor	The weather station can monitor the connection to the combination sensor. If a connection error is detected the "Connection error" communication object can send a telegram. Connection monitoring can be disabled, if necessary.
Wind signal	Monitor Do not monitor	In addition to monitoring the connection to the combination sensor, the weather station can determine whether the signals coming from this sensor are plausible. For this purpose, the weather station will check for what period the wind intensity remains unchanged and how long a possible calm period lasts. This plausibility check can be disabled, if necessary.
Max. "no wind" time in hours	10	If the wind sensor does not detect any wind for a time longer than the preset value, the weather station will interpret such situation as an error (e. g. icing up, mechanical malfunctioning) and send a corresponding telegram.



Sensor

Max. "wind unchanged" time in hours	10	If the wind sensor does not detect any change of the wind intensity for a time longer than the preset value, the weather station will interpret such situation as an error and send a corresponding telegram.
Date / time / astro function = internal clock		
DCF77 signal	Monitor Do not monitor	The combination sensor synchronizes after each reset or daily at 04:00 hrs. After successful synchronization, it internally reprocesses the time with an accuracy of 40 ppm (approx. 4 s/ 24 h) until the next synchronization on the following morning. If the synchronization was not successful the combination sensor will try to re-synchronize every hour. If this parameter has been set to "Monitor" the weather station will send an error message 5 minutes after an unsuccessful synchronization, with this message being repeated every 5 minutes.
Date / time / astro function = external clock		
External clock	Monitor Do not monitor	If the weather station works in combination with an external clock, it will use a software timer for the calculation of the time and the sun' position. Its accuracy depends on the scope of the other software functions. If the synchronization does not take place on a regular basis, it may result in a deviation of several minutes per day. If no date or time telegram has been received within 5 minutes of sending the request telegram, the „Error external clock“ with the value 1 will be send as long as the monitoring of the external clock is parameterized. In the case of this fault, a request telegram will be sent every 5 minutes. If the date and time has been received, the object will be reset to the value 0. The shading control will be enabled as well.
Max. brightness and twilight sensor, east, south, west	Activated Not activated	The communication object "Measured value, brightness and twilight" can be enabled here. The weather station evaluates the three directional brightness sensors and the twilight sensor of the combination sensor and calculates the greatest sensor value of these four sensors, which can then be transmitted to the bus using the "Measured value, brightness and twilight" communication object.

instabus KNX/EIB System

Sensor

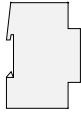

Transmit measured value on (10 s transmission delay)	0.5 % measurement difference 1 % measurement difference 3 % measurement difference 10 % measurement difference	The determined maximum measured value for brightness and twilight is transmitted to the bus when the change period specified here has elapsed. If the measured value only changes within the set measured value difference, then the measured value is not transmitted automatically.
Cyclical transmission of the measured value (x 10 s)	0 ... 120	The determined maximum measured value for brightness and twilight can also be transmitted cyclically to the bus to transmit a value change. This parameter defines the cycle time cyclic transmission. The "0" setting means that cyclic transmission is deactivated.



Sensor

 Combination sensor – Façades 1 – 4 shading Visible when date / time / astro function = „Internal clock enabled“ or „External clock enabled“		
Basic brightness threshold	Internal External	The shading function will become active when at least one of the three measured values of the internal brightness sensors exceeds the basic brightness threshold. If this parameter has been set to "External", the internal threshold (see next parameter) can be overwritten by an external value transmitter (e. g. touch sensor or visualization).
Shading basic brightness (lux * 1000)	10	This parameter specifies the threshold which must be exceeded to enable the shading function.
Basic brightness hystereses	3	This parameter specifies the hystereses for the basic brightness of the shading function.
Cycl. sending	Do not send 5 min cycle 10 min cycle 15 min cycle 20 min cycle 25 min cycle 30 min cycle 35 min cycle 40 min cycle	If desired, the weather station can send shading object telegrams in cycles.
Switch-on delay basic brightness	No delay 1 min delay 3 min delay 5 min delay 10 min delay 15 min delay 30 min delay 60 min delay	The time can be set with this function that has to lapse after at least one of the measured brightness values has exceeded the basic brightness until the automatic shading will be activated. This will prevent activating the shading caused by small breaks in an otherwise cloudy sky.
Switch-off delay Basic brightness	No delay 1 min delay 3 min delay 5 min delay 10 min delay 15 min delay 30 min delay 60 min delay	The time can be set with this function that has to lapse after all three measured brightness values have exceeded the basic brightness minus hystereses until the automatic shading will be deactivated. This will prevent deactivating the shading caused by individual clouds.

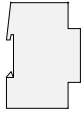

Format of shading objects	1-bit 1-byte (Position)	Depending on the shutter/blind actuators this is where it can be defined how they are actuated. If the actuators do not support any positioning, the 1-bit (Move) must be used. In this case the weather station will wait after receiving the telegram for moving so that all curtains reach their final position before they send telegrams for the positioning of the slats. If the actuators support the positioning of the slats and curtains, it will be reasonable to use the setting „1-byte (position)“. In this case no waiting times are required.
Waiting time between shading and slat position	No waiting time 1 min waiting time 2 min waiting time 3 min waiting time 4 min waiting time 5 min waiting time 6 min waiting time 7 min waiting time 8 min waiting time 9 min waiting time 10 min waiting time	The value of this parameter depends on the selected actuators (see parameter above) and the run-time of the curtains. If 1-bit objects are used for shading, the pre-setting will be 3 minutes. If 1-byte objects are used for shading, the pre-setting of this parameter will be waiting time.
Send curtain height after shading has ended	Yes No	This parameter helps to prevent an actuator to activate an internally stored, old value for the curtain height after shading has ended. If set to “Yes”, the curtain height will be set to zero and send after the end of shading. If set to “No”, no telegram will be send.
Send slat position after the end of shading	Yes No	This parameter helps to prevent an actuator to activate an internally stored, old value for the slat position after shading has ended. If set to “Yes”, the slat position will be set to zero and send after the end of shading. If set to “No”, no telegram will be send.



Sensor

Cycl. sending of slat position (x 1 min)	0 ... 30 ... 255	If desired, the weather station can send telegrams for adjusting the slats in cycles. The cycle time should not be too short as the sound caused by the temporary starting and stopping of the motors may be bothering.
Send slat position in case of	1° change of the sun's angle (elevation) 3° change of the sun's angle (elevation) 5° change of the sun's angle (elevation) 10° change of the sun's angle (elevation) 15° change of the sun's angle (elevation)	In order to achieve an optimum shading that depends on the position of the sun, the slats should be exactly aligned at an angle of 90° to the sun's elevation at any given time. Since the smallest possible increment of the drives is limited and the noises caused by the momentary starting and stopping of the motors for the slat adjustment might be bothersome, this parameter allows the user to define how accurately the drives will follow the course of the sun.
Individual control Façade ...		
Façade orientation (°)	0	What direction does the building façade face? North: 0° East: 90° South: 180° West: 270°
Opening angle towards sun	Internal External	If this parameter has been set to "External", the internal opening angle (see next parameter) can be overwritten by an external value transmitter (e. g. touch sensor or visualization).
Opening angle in °	150	When should the shading function for this façade be initiated. 0°: No shading 1°: When the sun is shining on the façade almost vertically. 150°: When the sun is shining on the façade at an angle more acute than 15°. 179°: As soon as the sun is shining on the façade only at a minimum.



Type of curtain height object	1-bit switching 1-byte (value)	Depending on the object type, it is possible to either control sun protection objects or shutter/blind position objects of the shutter/blind actuators. When using 1-bit objects, the curtain height for the different thresholds must be stored in the actuators. When using the 1-byte objects, the weather station will send the curtain positions defined for the respective elevation.
Activate threshold ...	Yes No	This parameter is used to make the objects and parameters for the threshold visible or invisible.
Angle of the sun's position threshold ... (°)	0 ... 15 ... 90	Angle of the sun's position (elevation), above which the threshold 1 object will accept the value 1 for this Façade.
Type of curtain object = 1-byte		
Curtain height threshold ... (%)	0 ... 80 ... 100	Value that will be send via the curtain height threshold/position object of this Façade in case of exceeding the angle of the sun's position (previous parameter).
Slat control		
Slat position for max. shading (%)	0 ... 100	The internal calculation uses a slat adjustment angle from 0...100% . By using these parameters, the slat position can be scaled to a different range of values.
Slat position for min. shading (%)	0 ... 50 ... 100	
Offset slat position (%)	0 ... 100	This parameter allows to adjust the slat relative to the sun's elevation. The preset value "0" corresponds to an orientation of the slats at an angle of 90° towards the sun.





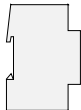

Façade control		
Block Façade control	Yes No	This parameter determines whether the objects and parameters for the blocking function of this Façade will become visible (Yes) or invisible (No).
Polarity of blocking object	0 = enabled, 1 = blocked 0 = blocked, 1 = enabled	This parameter determines the object value which will cause the automatic shading control of this Façade to be blocked.
Behaviour at the beginning of the blocking Behaviour at the end of the blocking	No action Send parameterized status No action Send parameterized status	If the blocking function of the Façade control is to be used, the other parameters can be used to define the response to a change of value of the blocking object. The possible settings depend on the selected types of the objects for curtain height and shading.
If type of curtain type object = 1-byte and Behaviour at the beginning of the blocking = Send parameterized status		
Curtain height	No action Send curtain height	Behaviour of object of this Façade at the beginning of the blocking. No action: The object will be send only after the next change. Send curtain height: The value of the following parameter will be send.
Value curtain height (%)	0 ... 100	
If type of shading objects = 1-bit and Behaviour at the beginning of the blocking = Send parameterized status		
Shading bit	No action Send shading bit	Behaviour of object of this Façade at the beginning of the blocking. No action: The object will be send only after the next change. Send shading bit: The value of the following parameter will be send.
Value shading bit	0, 1	



If type of shading bit = 1-byte and Behaviour at the beginning of the blocking = Send parameterized status		
Shading byte	<p>No action</p> <p>Send shading byte</p>	<p>Behaviour of object of this Façade at the beginning of the blocking.</p> <p>No action: The object will be send only after the next change.</p> <p>Send shading byte: The value of the following parameter will be send.</p>
Value shading byte (%)	0 ... 100	
If behaviour at the beginning of the blocking = Send parameterized status		
Slat position	<p>No action</p> <p>Send slat position</p>	<p>Behaviour of object at the beginning of the blocking.</p> <p>No action: The object will be send only after the next change.</p> <p>Send slat position: The value of the following parameter will be send.</p>
Value slat position (%)	0 ... 100	
If type of curtain height object = 1-byte and Behaviour at the end of the blocking = Send parameterized status		
Curtain height	<p>Send curtain height</p> <p>Tracking</p>	<p>Behaviour of object of this Façade at the beginning of the blocking.</p> <p>Send curtain height: The value of the following parameter will be send.</p> <p>Tracking: The current object value will be send.</p>
Value curtain height (%)	0 ... 100	
If type of shading objects = 1-bit and Behaviour at he end of the blocking = Send parameterized status		
Shading bit	<p>Send shading bit</p> <p>Tracking</p>	<p>Behaviour of object of this Façade at the beginning of the blocking.</p> <p>Send shading bit: The value of the following parameter will be send.</p> <p>Tracking: The current object value will be send</p>
Value shading bit	0 , 1	



If type of shading objects = 1-byte and Behaviour at the end of the blocking = Send parameterized status		
Shading byte	Send shading bytes Tracking	Behaviour of object of this Façade at the beginning of the blocking. Send shading byte: The value of the following parameter will be send. Tracking: The current object value will be send
Value shading byte (%)	0 ... 100	
If behaviour at the end of the blocking = Send parameterized status		
Slat position	Send slat position Tracking	Behaviour of object of this Façade at the beginning of the blocking. Send slat position: The value of the following parameter will be send. Tracking: The current object value will send
Value slat position (%)	0 ... 100	
 Sun East – refer to brightness analog input.		
 Sun South – refer to brightness analog input.		
 Sun West – refer to brightness analog input.		
 Twilight – refer to twilight analog input.		
 Wind – refer to wind analog input.		



 Precipitation – refer to precipitation analog input.		
Output	No precipitation = 0, Precipitation = 1 No precipitation = 1, Precipitation = 0	This parameter specifies which telegram is transmitted by the "Precipitation" object of rain or dry weather.
Rain detection	Very sensitive Sensitive Normal Slow	The sensitivity of the rain detection can be set here. Within a fixed time period (50 s), the combination sensor calculates the strength of the precipitation by counting the raindrops. The number of raindrops leading to the detection of precipitation are set using this parameter and are represented by sensitivity levels. Precipitation is considered as over when, within the fixed time period, no more raindrops are counted.
Switch-on delay	No delay 1 s delay 3 s delay 5 s delay 10 s delay 15 s delay 30 s delay 1 min delay 3 min delay 5 min delay 10 min delay 15 min delay 30 min delay 6 min delay	If precipitation is still detected after the time set here, then the precipitation signal is internally detected as being valid and is processed further within the weather station. It may be that telegram transmission to the bus via the "Precipitation" object only takes place then.
Switch-off delay	No delay 1 s delay 3 s delay 5 s delay 10 s delay 15 s delay 30 s delay 1 min delay 3 min delay 5 min delay 10 min delay 15 min delay 30 min delay 6 min delay	Only when no more precipitation is detected after the time set here is the precipitation considered as actually over. Note: The time set here is always lengthened by the fixed period of time (50 s) to detect precipitation!



Transmit on value change	Yes No	If the parameter is set to "Yes", and a value change is detected after the delay times set above, then the weather station will send the appropriate telegram.
Cyclical transmission (x 10 s)	0 ... 120	Cyclic transmission takes place independently of the telegrams due to value changes. The telegrams are not transmitted cyclically in the "0" presetting.

Remarks on the software

If the combination sensor is connected to a weather station with the current user software (weather station B00602) and the current firmware, the login of the combination sensor will take place automatically.