

Product name:	<b>Presence detector 'Komfort'</b>
Design:	Surface-mounted
Item no.:	<b>0304 0x</b>
ETS search path:	Gira Giersiepen, Phys. sensors, movement detectors, presence detector komfort

#### Functional description:

The presence detector 'Komfort' is used for the detection of presence (presence detector mode), for the detection of movements (ceiling-mounted detector mode) and for the supervision of signalling telegrams (signalling mode) in rooms.

In these three modes of operation, the device offers 4 output channels, two of which can be active in one mode of operation respectively and which can be independently parameterized. The modes of operation presence detector, ceiling-mounted detector and signalling mode can be defined when the device is parameterized with the ETS software.

The detector is provided with an alarm function which is activated when the device is removed from the bus coupler.

The presence detector 'Komfort' can be used as a stand-alone unit, as master (main unit) or slave unit (extension unit) and should be mounted exclusively under the room ceiling from where it monitors the area below.

The detector is equipped with a passive infrared sensor (PIR) and responds to thermal movements triggered by persons, animals or objects.

To extend the detection range, several presence detectors can be used in the same room by combining a device parameterized as master with several other devices parameterized as slaves.

It is also possible to connect the presence detector 'Komfort' to a flush-mounted 'Komfort' detector parameterized as a slave unit or with the flush-mounted 'Standard' detector in an extension application.

The purpose of a presence detector is to switch on the light depending on brightness when a movement is detected, and to switch it off when it is no longer needed. This is the case when there is sufficient brightness without any additional artificial light, and when nobody is present anymore.

This means that the presence of a person is detected depending on a preset brightness.

#### Illustration:

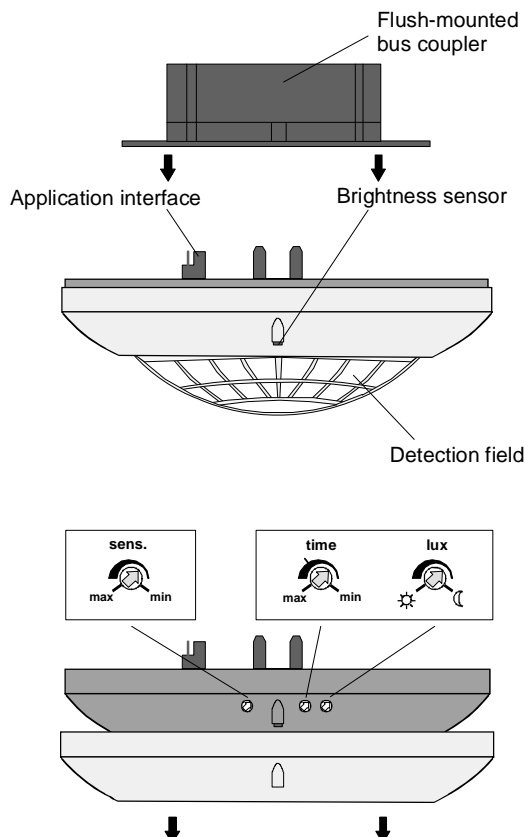

#### Dimensions:

Diameter: 104 mm  
Height: 40 mm

#### Controls:

- 1 potentiometer for infinitely variable reduction of the detection range between 100 % and 20%
- 1 potentiometer for setting an additional transmit delay by  $\pm 50\%$ , parameterized setting = center position of potentiometer (cf. 'Software comments').
- 1 potentiometer for fine setting of the twilight value preset by the software (cf. 'Software comments').
- 1 brightness sensor

# instabus EIB System

## Sensor

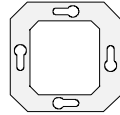

---

### Specifications:

---

External supply	---
instabus EIB supply	
Voltage:	24 VDC (+6 V / -4 V)
Power consumption:	typically 150 mW
Connection:	instabus connecting and branch terminal
Input:	
Angle of detection:	360°
Nominal range at desktop height:	∅ approx. 5 m
Nominal range at floor level:	∅ approx. 8 m
Fitting height for nominal range:	approx. 2.5 m
Number of lenses / detection levels:	80 / 6
Output:	---
Response to voltage failure	
Bus voltage only:	No response. (In case of bus voltage failure, active movements detected or running delay times are discarded and not continued after bus voltage recovery.)
Mains voltage only:	---
Bus and mains voltage:	---
Response on reactivation	
Bus voltage only:	parameter-dependent (immunity period of thermal movement detection: approx. 40 s)
Mains voltage only:	---
Bus and mains voltage:	---
Degree of protection:	IP 20
Mark of approval:	EIB
Ambient temperature:	-5 °C to +45 °C
Storage temperature:	-25 °C to +75 °C (storage above +45 °C reduces lifetime)
Fitting position:	any (not for ceiling-mounted device)
Minimum distances:	none
Type of fixing:	plugs into flush-mounted bus coupler

---

### Wiring diagram:

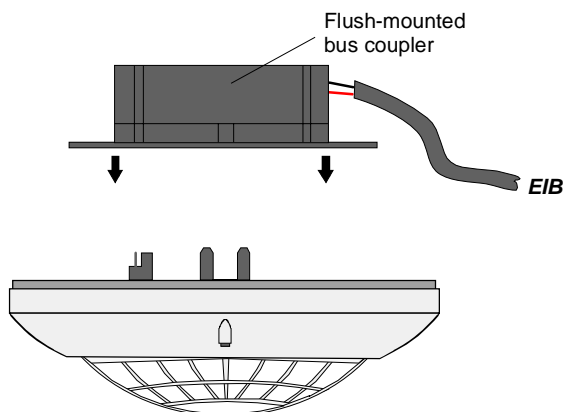

### Terminal assignment:

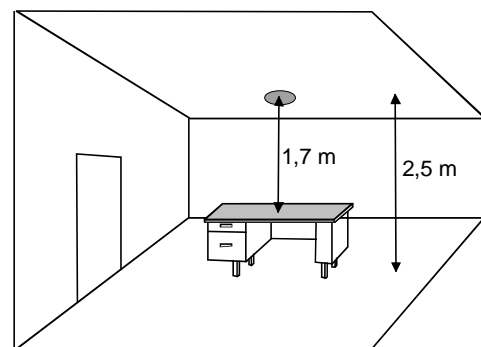



**Detection field:**

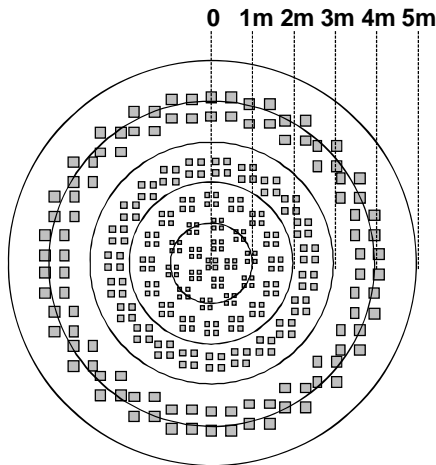

The presence detector 'Komfort' has a detection field of 360°.

The PIR sensors use six detection levels and 80 lenses.

At desktop height (approx. 80 cm), the detection field is about 5 m in diameter. At floor level, the diameter of the detection field is about 8 m.

These values are obtained when the detector is installed under the ceiling at a height of 2.5 m.

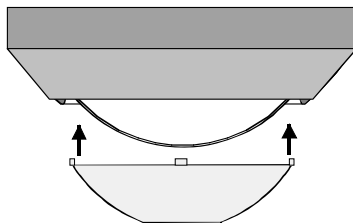
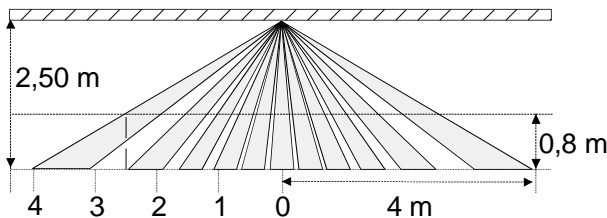

The snap-on mask supplied can be used to blank out undesired zones of detection or sources of interference by restricting the field of detection.

The mask is snap-fastened on the lens system. The mask can be cut out as required along the marked lines with a pair of scissors.

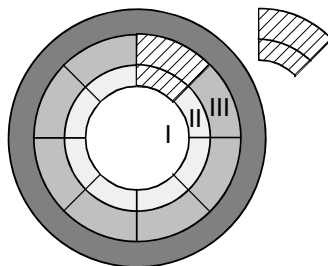

Cutting out changes the diameter of the detection field on the floor as follows:

- Complete mask without cutouts, zone I:     ∅ approx. 2.20 m
- Zone II cut out:         ∅ approx. 4.00 m
- Zones II+III cut out:   ∅ approx. 6.00 m
- without mask:           ∅ approx. 8.00 m

The diameters are referred to an installation height of approx. 2.50 m.

## instabus EIB System

### Sensor

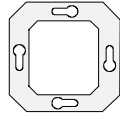

#### Remarks on the hardware:

- Do not install the presence detector in the direct vicinity of heat sources as, for instance, lamps. Cooling of the lamp might be interpreted by the PIR sensor as a thermal change and trigger another detection cycle.  
If necessary, the detecting range must be confined by means of the snap-on mask supplied with the device.  
The presence detector must not be installed close to fans, radiators or ventilation ducts. Draughts (also from open windows) might be detected as movements and cause retriggering of the device. Select the most suitable place for the installation.
- Install the presence detector 'Komfort' in a place unaffected by vibrations, since the device may also be triggered by movements of the sensor.
- The field of detection should not be restricted by obstacles such as furniture, columns, etc.
- The brightness sensor should be installed on the side away from the window to avoid the undesired influence of scattered light.
- The brightness values detected by the presence detector depend on several conditions.  
Thus, the reflexion of light by the surface directly under the presence detector is of decisive importance. Bright surfaces such as white paper on a desktop reflect of course much more light than a dark carpet. It may therefore be necessary to change the setting of a presence detector when the bright desktop below is moved to another place in the room and when there is now a dark carpet under the detector instead.
- The less movements are expected in the supervised area, the longer should be the selected additional transmit delay period. Premature extinction of the light can thus be avoided.



---

**Software Description:**

ETS search path:

Gira Giersiepen, Phys. sensors, movement detectors, presence detector komfort

ETS symbol:

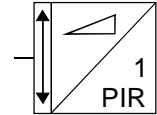

---

**Applications:**

Brief description:

Presence Komfort

Name:

Presence Komfort A00F01

Date:

03.03

Page:

7

Data base

2.50

**instabus EIB System**

**Sensor**

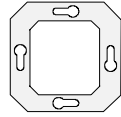



---

**Application: Presence Komfort A00F01**

---

- Possibility of changing over between 2 independent modes of operation with 2 outputs each.
- The "switching", "dimming value transmitter", "lightscape extension" and "signalling" (only in "signalling mode") functions can be freely assigned to the 4 outputs.
- The " temperature value transmitter" or the "brightness value transmitter" functions can be additionally assigned to output 1.
- Presence detector, ceiling detector or signalling modes can be parameterized for each mode of operation. The two modes of operation can be changed in operation with a mode-of-operation object,
- Application as stand-alone unit, master or slave selectable. The device can be operated with other 'Komfort' presence detectors that are parameterized as extensions or with 'Standard' detectors and 'Komfort' detectors as extensions.
- The potentiometers for twilight value and additional transmit delay act on a programmable output.
- Interlock after release of telegram adjustable.
- Telegram delay on start of detection can be parameterized.
- Twilight level and teach-in function can be parameterized independently for each output. When operated as master (main unit), the twilight level can be evaluated optionally in the main unit and in the extension unit or in the main unit only. For teach-in objects, the polarities can be predefined.
- Cyclic transmission during detection possible (base and factor),
- Telegram release on retriggering can be parameterized.
- Telegram transmission at the beginning and at the end of a detection adjustable.
- Telegram transmission at the beginning and at the end of a detection in inhibit mode adjustable. The inhibit object polarities can be parameterized independently.
- Additional transmit delay (basic value and factor) adjustable. The total delay for telegram transmission at the end of detection is obtained by adding the standard delay (10 s) and the additional transmit delay.
- Adjustable shut-off hysteresis correction: after the value of the preset twilight brightness level is exceeded by the double (shut-off brightness), the device transmits the parameterized telegram at the end of detection ca. 10 minutes later even if persons are still present. The shut-off brightness can be varied by means of the correction factor
- The response on return of bus voltage can be parameterized independently for each output,
- Removal alarm after withdrawal of the device from the flush-mounted bus coupler possible (1 bit / 1 byte).

## instabus EIB System

### Sensor

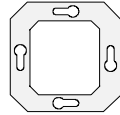

Object	Object description
□↔ 0 - 3 <b>Switching:</b>	1 bit object for transmission of switching telegrams (ON, OFF)
□↔ 0 - 3 <b>Value:</b>	1 byte object for transmission of e.g. value telegrams (0 - 255)
□↔ 0 - 3 <b>Lightscape extension:</b>	1 byte object for calling up or saving of lightscapes (1 - 64)
□↔ 0 - 3 <b>Signalling:</b>	1 bit object for transmission of signalling telegrams (ON, OFF)
□   0 <b>Temperature value:</b>	2 byte object for transmission of temperature values
□↔ 0 <b>Brightness value:</b>	2 byte object for transmission of brightness values
□↔ 4 <b>Communication to main unit:</b>	1 bit object for bidirectional communication of movement signals to main unit
□↔ 4 <b>Communication to extension unit:</b>	1 bit object for bidirectional communication of movement signals to extension unit
□↔ 5 <b>Operating mode selection:</b>	1 bit object for changing the mode of operation
□↔ 6 - 7 <b>Inhibit:</b>	1 bit object for inhibiting outputs
□↔ 8 - 9 <b>Teach-in:</b>	1 bit object for twilight value setting independent of parameterization and of twilight value potentiometer setting
□↔ 10 <b>Brightness (in)dependent detection:</b>	1 bit object for switching over between brightness-independent and brightness-dependent operation
□↔ 11 <b>Switching:</b>	1 bit object for alarm signalling (presence detector removed)
□↔ 11 <b>Value:</b>	1 byte object for alarm signalling (presence detector removed)





Number of addresses (max):	20	dynamic table management	Yes <input checked="" type="checkbox"/>	No <input type="checkbox"/>
Number of assignments (max):	21	maximum length of table	41	
Communication objects:	12			

Function: "no function" <sup>\*\*\*</sup>)

No further output objects

Function: "Switching" <sup>\*\*\*</sup>)

Object:	Function:	Name:	Type:	Flag:
<input type="checkbox"/> 0	Switching	Output 1	1 Bit	S,K,(Ü) <sup>**</sup> ,(L) <sup>*</sup>
<input type="checkbox"/> 1	Switching	Output 2	1 Bit	S,K,(Ü) <sup>**</sup> ,(L) <sup>*</sup>
<input type="checkbox"/> 2	Switching	Output 3	1 Bit	S,K,(Ü) <sup>**</sup> ,(L) <sup>*</sup>
<input type="checkbox"/> 3	Switching	Output 4	1 Bit	S,K,(Ü) <sup>**</sup> ,(L) <sup>*</sup>

Function: "Dimming value transmitter" <sup>\*\*\*</sup>)

Object:	Function:	Name:	Type:	Flag:
<input type="checkbox"/> 0	Value	Output 1	1 Byte	S,K,(Ü) <sup>**</sup> ,(L) <sup>*</sup>
<input type="checkbox"/> 1	Value	Output 2	1 Byte	S,K,(Ü) <sup>**</sup> ,(L) <sup>*</sup>
<input type="checkbox"/> 2	Value	Output 3	1 Byte	S,K,(Ü) <sup>**</sup> ,(L) <sup>*</sup>
<input type="checkbox"/> 3	Value	Output 4	1 Byte	S,K,(Ü) <sup>**</sup> ,(L) <sup>*</sup>

Function: "Lightscape Extension" <sup>\*\*\*</sup>)

Object:	Function:	Name:	Type:	Flag:
<input type="checkbox"/> 0	Lightscape extension	Output 1	1 Byte	S,K,(Ü) <sup>**</sup> ,(L) <sup>*</sup>
<input type="checkbox"/> 1	Lightscape extension	Output 2	1 Byte	S,K,(Ü) <sup>**</sup> ,(L) <sup>*</sup>
<input type="checkbox"/> 2	Lightscape extension	Output 3	1 Byte	S,K,(Ü) <sup>**</sup> ,(L) <sup>*</sup>
<input type="checkbox"/> 3	Lightscape extension	Output 4	1 Byte	S,K,(Ü) <sup>**</sup> ,(L) <sup>*</sup>

Function: "Signalling" <sup>\*\*\*</sup>)

Object:	Function:	Name:	Type:	Flag:
<input type="checkbox"/> 0	Signalling	Output 1	1 Bit	S,K,Ü,(L) <sup>*</sup>
<input type="checkbox"/> 1	Signalling	Output 2	1 Bit	S,K,Ü,(L) <sup>*</sup>
<input type="checkbox"/> 2	Signalling	Output 3	1 Bit	S,K,Ü,(L) <sup>*</sup>
<input type="checkbox"/> 3	MelSignallingden	Output 4	1 Bit	S,K,Ü,(L) <sup>*</sup>

Function: "Temperature value transmitter" <sup>\*\*\*\*</sup>)

Object:	Function:	Name:	Type:	Flag:
<input type="checkbox"/> 0	Temperature value	Output 1	2 Byte	K,(S,Ü) <sup>**</sup> ,(L) <sup>*</sup>

Function: "Brightness value transmitter" <sup>\*\*\*\*</sup>)

Object:	Function:	Name:	Type:	Flag:
<input type="checkbox"/> 0	Brightness value	Output 1	2 Byte	S,K,(Ü) <sup>**</sup> ,(L) <sup>*</sup>

\* For the objects marked (L), the object status can be read out (set L-Flag).

\*\* These flags are set or removed dependent on the type of application.

\*\*\* The "no function", "switching", "dimming value transmitter", "lightscape extension" and "signalling" (only in signalling mode) functions can be selected per output. The names of the communication objects and the object table (dynamic object structure) change accordingly.

\*\*\*\* "Temperature value transmitter" and "Brightness value transmitter" can only be selected for output 1. The names of the communication objects and the object table (dynamic object structure) change accordingly.

# instabus EIB System

## Sensor

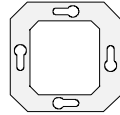

### General

Object:	Function:	Name:	Type:	Flag:
☐↵ 4	Communication with main / extension unit	Movement	1 Bit	S,K,Ü,(L)*
☐↵ 5	Mode-of-operation change-over	Mode	1 Bit	S,K,Ü,(L)*
☐↵ 6	Inhibit object 1	Inhibit	1 Bit	S,K,(L)*
☐↵ 7	Inhibit object 2	Inhibit	1 Bit	S,K,(L)*
☐↵ 8	Teach-in object 1	Teach-in	1 Bit	S,K,(L)*
☐↵ 9	Teach-in object 2	Teach-in	1 Bit	S,K,(L)*
☐↵ 10	Brightness-(in)dependent detection	Twilight level	1 Bit	S,K,(Ü)**,(L)*

### 1 Bit Data Format Alarm Function

Object:	Function:	Name:	Type:	Flag:
☐↵ 11	Switching	Alarm	1 Bit	K,S,Ü,(L)*

### 1 Byte Data Format Alarm Function

Object:	Function:	Name:	Type:	Flag:
☐↵ 11	Switching	Alarm	1 Byte	K,S,Ü,(L)*

\* For the objects marked (L), the object status can be read out (set L-Flag).

\*\* These flags are set or removed dependent on the type of application.

\*\*\* The "no function", "switching", "dimming value transmitter", "lightscape extension" and "signalling" (only in signalling mode) functions can be selected per output. The names of the communication objects and the object table (dynamic object structure) change accordingly.

\*\*\*\* "Temperature value transmitter" and "Brightness value transmitter" can only be selected for output 1. The names of the communication objects and the object table (dynamic object structure) change accordingly.



## Detection of removal / Removal alarm

When the application module is removed from the bus coupler, an ON or OFF telegram or a value telegram can be released via the alarm object. The release of this telegram can be suppressed with ETS parameter setting "alarm function inhibited" (default).

The time between removal of module and release of telegram can be preset with the ETS parameters time factor and time basic value. To exclude bouncing effects, the time span set should not be less than 1 second.

### Data format: 1 bit

- a) Automatic reset after sabotage attempt = yes (default)

When the application module is plugged in for the first time after programming by the ETS, the object value of the alarm object is charged with the inverted alarm value (no alarm active) and the alarm function enabled. As long as, after programming, no application module is plugged in, this state can be detected when querying the object value, as in this case the alarm object value is charged with the alarm value (alarm active).

When the application module is removed, an alarm telegram with the parameterized alarm value (alarm active) will be transmitted after the transmit delay has elapsed.

On bus voltage failure and on return of bus voltage, no new alarm telegram will be transmitted.

After replacing the application module on the coupler, an inverted alarm telegram (no alarm active) will be transmitted and the device enabled (device ready to operate).

- b) Automatic reset after sabotage attempt = no

When the application module is plugged in for the first time after programming by the ETS, the object value of the alarm object is charged with the inverted alarm value (no alarm active) and the alarm function enabled. As long as, after programming, no application module is plugged in, this state can be detected when querying the object value, as in this case the alarm object value is charged with the alarm value (alarm active).

When the application module is removed, an alarm telegram with the parameterized alarm value (alarm active) will be transmitted after the transmit delay has elapsed.

On bus voltage failure and on return of bus voltage, no new alarm telegram will be transmitted.

After replacing the application module on the coupler, the device is inhibited (device not ready to operate).

Only after receiving the inverted alarm value (enable telegram) will the device be re-enabled.

On receiving the enable telegram, the application module must be in place on the coupler. If the module is not plugged in, there will be no enabling and the object value remains set on the alarm value (alarm active). (The enable telegram with the inverted alarm value will be ignored).

## instabus EIB System

### Sensor

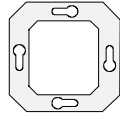

#### Data format: 1 byte

- a) Automatic reset after sabotage attempt = yes (default)

When the application module is plugged in for the first time after programming by the ETS, the object value of the alarm object is charged with value = 0 (no alarm active) and the alarm function enabled. As long as, after programming, no application module is plugged in, this state can be detected when querying the object value, as in this case the alarm object value is charged with the alarm value (1 ... 255 = alarm active).

When the application module is removed, an alarm telegram with the parameterized alarm value (1 ... 255 = alarm active) will be transmitted after the transmit delay has elapsed. On bus voltage failure and on return of bus voltage, no new alarm telegram will be transmitted.

After replacing the application module on the coupler, a telegram with value = 0 (no alarm active) will be transmitted and the device enabled (device ready to operate).

- b) Automatic reset after sabotage attempt = no

When the application module is plugged in for the first time after programming by the ETS, the object value of the alarm object is charged with value = 0 (no alarm active) and the alarm function enabled. As long as, after programming, no application module is plugged in, this state can be detected when querying the object value, as in this case the alarm object value is charged with the alarm value (1 ... 255 = alarm active).

When the application module is removed, an alarm telegram with the parameterized alarm value (1 ... 255 = alarm active) will be transmitted after the transmit delay has elapsed. On bus voltage failure and on return of bus voltage, no new alarm telegram will be transmitted.

After replacing the application module on the coupler, the device is inhibited (device not ready to operate).

Only after receiving an alarm telegram with value = 0 (enable telegram) will the device be re-enabled.

On receiving the enable telegram, the application module must be in place on the coupler. If the module is not plugged in, there will be no enabling and the object value remains set on the alarm value (1 ... 255 = alarm active). (The enable telegram with value = 0 will be ignored).



## Modes of operation

The presence detector 'Komfort' has 3 modes of operation: "presence detector mode", "ceiling detector mode" and "signalling mode", 2 of which can be predefined and activated independently (cf. "Mode of operation change-over"). The modes of operation that can be activated are defined in the ETS when the device is parameterized.

The functions of a presence detector differ from those of a ceiling detector in the following features:

a) *Handling of movement signals:*

Contrary to the normal detecting function, a presence detector recognizes the presence of a person only after several subsequent movement pulses have been received.

A ceiling detector offers in addition the possibility of setting the sensitivity of the PIR sensors by means of software parameters.

b) *Handling of brightness signals:*

The adjustable brightness range to be evaluated as twilight switching level in a presence detector is greater than in the ceiling detector mode.

Ca. 10 minutes after the value of the preset twilight brightness level has been exceeded by the double (shut-off brightness), the device transmits the parameterized telegram at the end of detection even if persons are still present and switches off the light.

The shut-off brightness can be changed by means of a correction factor in the parameters.

c) *Combined evaluation of brightness and movement signals:*

A presence detector switches on the load (e.g. light and heating) when needed, i.e. after detecting the presence of a person and after sensing a brightness level below the preset twilight level.

The load is switched off when it is no longer needed, i.e. if nobody is present anymore and if it is bright enough even without additional lighting.

A ceiling detector on the other hand switches on the load when the ambient brightness is below the preset twilight level. The detector switches off, independent of brightness, only after there are no movements anymore.

Presence detectors and ceiling detectors can optionally also operate independent of brightness. In this case, the devices or rather their outputs, when parameterized as brightness-independent outputs, behave identically as far as the brightness evaluation is concerned.

In the signalling mode, the device's response to detected movements is 'slower', as the output object transmits a signalling telegram only after having taken several samples of the movement signal.

The criterion for transmitting a signalling telegram is the parameterized number X of movement pulses occurring within a monitoring time which can freely selected. The evaluation of brightness in the signalling mode is always independent of brightness. The PIR sensors work like in the ceiling detector, i.e. their sensitivity can be adjusted.

## Ceiling detector mode

In the ceiling detector mode, the device detects movements and transmits the telegram at the beginning of detection (stand-alone or main unit) or the movement telegram (main unit or extension) when the measured brightness is below the preset twilight level. In the main unit mode, the brightness can optionally be evaluated in the main unit alone or in the main and in the extension unit (default). The telegram at the beginning of detection can be transmitted with a time delay (see description of telegram delay). After transmission of the telegram at the beginning of detection, the device works independent of the ambient brightness. If no further movements are detected, the device transmits the parameterized telegram at the end of detection after the preset total transmit delay (standard delay (10 s) + additional transmit delay).

The light can be switched on and off independent of movement detection also in those cases where a ceiling detector is inhibited and when the bus voltage returns.

Sensor

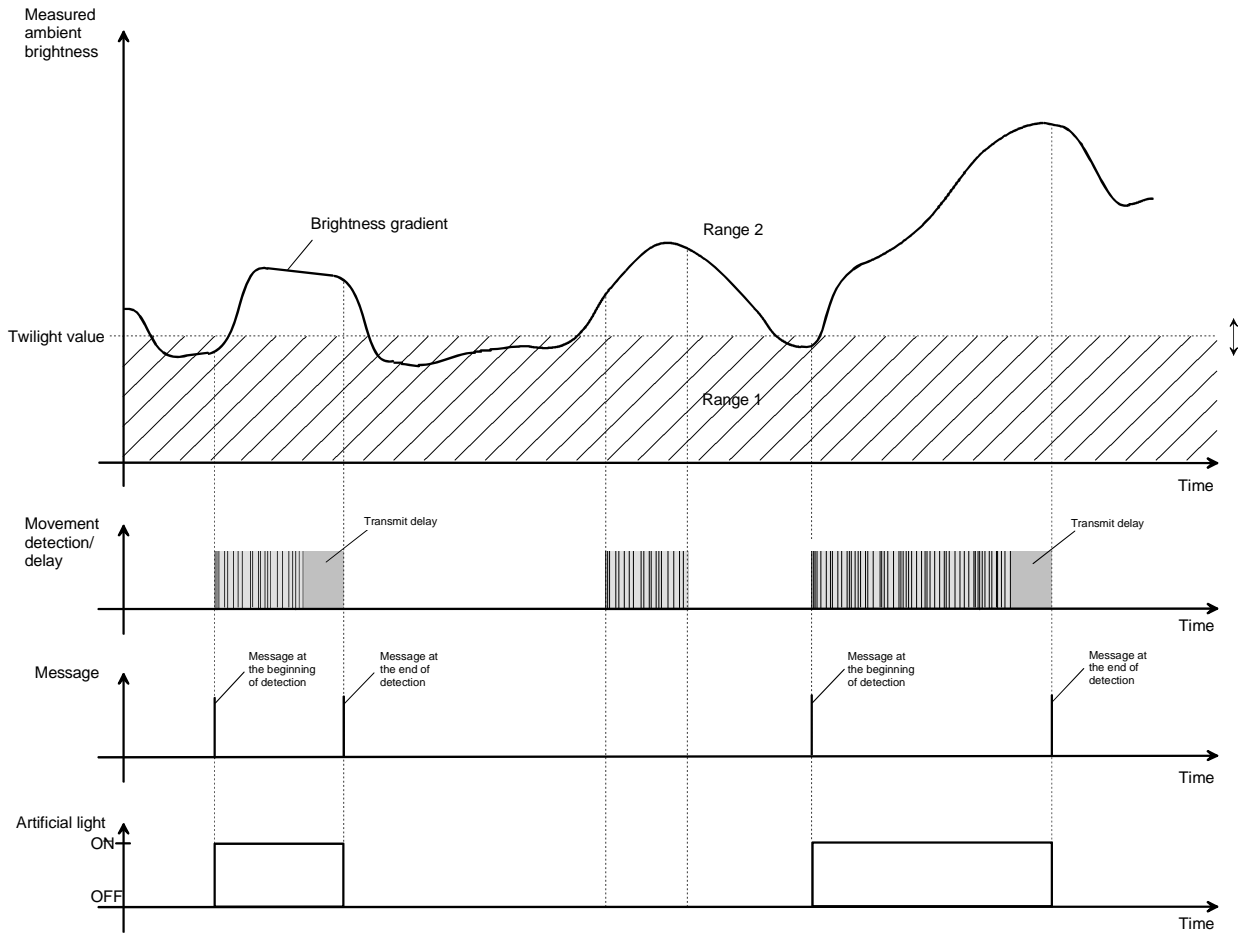

The brightness limit between range 1 and range 2 is determined by the twilight value, which can be parameterized and, if needed, adjusted with the twilight potentiometer. If the ambient brightness measured falls below this value and if presence is detected, the ceiling detector switches on the artificial light. Range 2 represents the brightness in the room at which the room is sufficiently illuminated and where no artificial lights need to be switched on. If the ambient brightness lies in this range and if the device then detects a movement, no artificial light will be switched on.

The 'sensitivity' parameter defines how strong the movement pulses evaluated must be for a movement to be detected. It is thus possible to reduce the sensitivity of the PIR sensors to avoid false triggering.

If the twilight level is parameterized "brightness-independent", the artificial light is always switched on when movements are detected without monitoring the ambient brightness.

**Presence detector mode**

In the presence detector mode, the device detects the presence of a person and transmits the parameterized telegram at the beginning of detection (stand-alone or master unit) or the movement telegram (master or slave unit) when the measured brightness value is below the preset twilight level. In the master unit mode, the brightness evaluation can optionally be effected in the master unit alone or in the master and in the slave unit (default). The telegram at the beginning of detection can be transmitted with a time delay (see description on telegram delays).

When no presence is detected anymore and when the preset overall transmit delay (standard delay (10 s) + additional transmit delay) has elapsed or when the preset twilight level exceeds the parameterizable shut-off threshold for at least 10 minutes, the presence detector transmits the parameterized telegram at the end of detection.

The light can also be switched on or off independently of movement detection when the presence detector is inhibited or when the bus voltage returns.

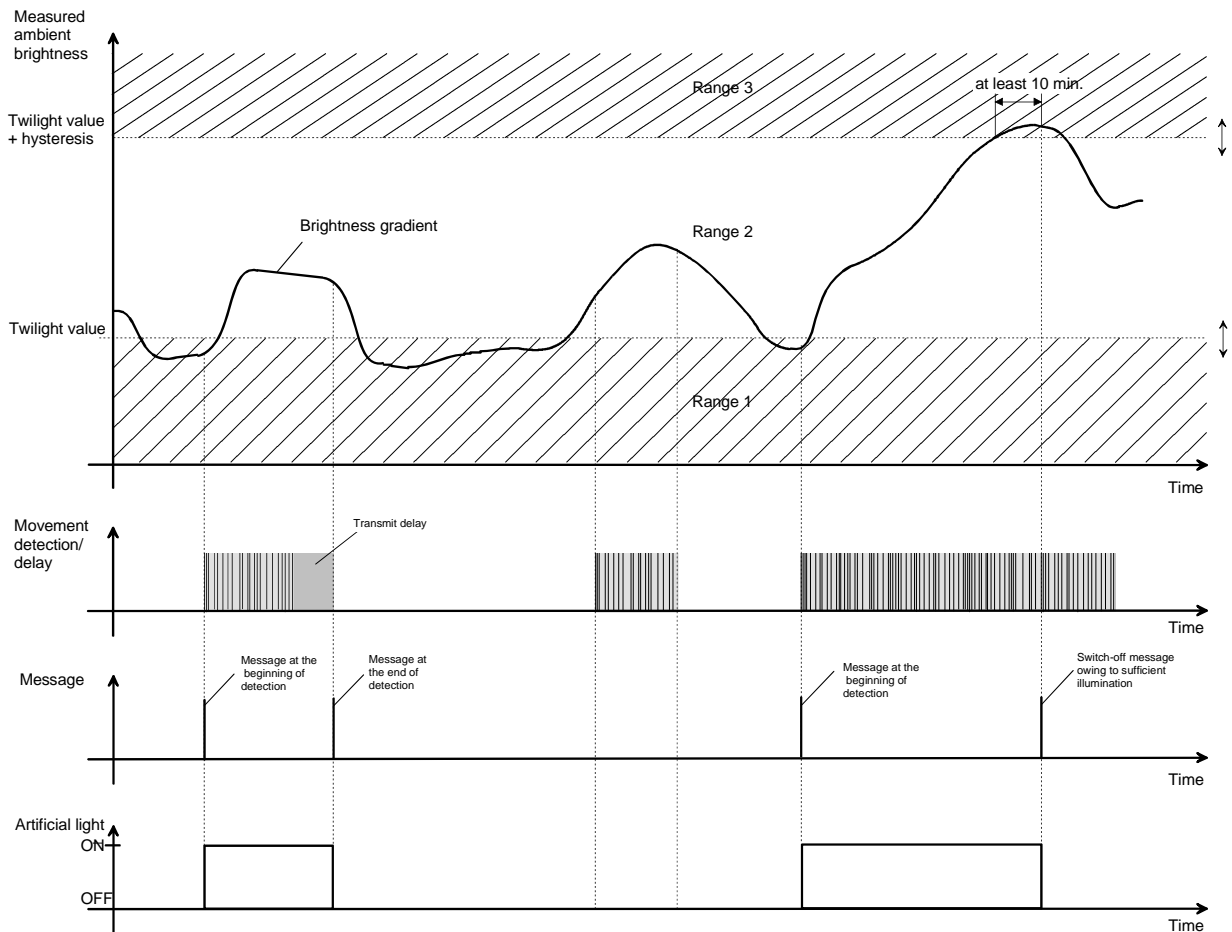

The brightness limit between range 1 and range 2 is determined by the twilight value, which can be parameterized and, if needed, adjusted with the twilight potentiometer. If the ambient brightness measured falls below this value and if presence is detected, the presence detector switches on the artificial light. Range 2 represents the brightness in the room to be regulated by the presence detector. If the ambient brightness lies in this range and if the device then detects a new movement, no artificial light will be switched on additionally. The boundary between ranges 2 and 3 is determined by the twilight level plus hysteresis (cf. description of "Hysteresis and correction factor in the presence detector mode" next page). If the measured ambient brightness exceeds this brightness threshold in permanence, the artificial light is switched off not before 10 minutes. The time to shut-off can be longer than 10 minutes, if the ambient brightness does not exceed the boundary between ranges 2 and 3 in permanence, i.e. if the brightness is at times lower and at other times higher again. This shut-off time has a 'debouncing effect' for short-term light reflexes and prevents false triggering of the lighting.

If the twilight level is parameterized as "brightness-independent", the artificial light is always switched on when presence is detected without monitoring the ambient brightness.

#### Important:

If presence detection is used for controlling a heating system, the brightness signal should not be evaluated (setting of twilight level = "brightness-independent").

# instabus EIB System

## Sensor

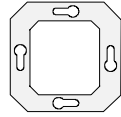

### Hysteresis and correction factor in the presence detector mode:

The boundary between ranges 2 and 3 (shut-off threshold can be parameterized and adapted to ambient conditions. If it is found that the artificial light is shut off too early (too late), the shut-off threshold can be corrected for higher (lower) values. This shift of the shut-off threshold is described by the correction factor ("correction of shut-off hysteresis").

In the standard case, the hysteresis corresponds to twice the value (100 %) of the parameterized twilight level. If the threshold is to be corrected for lower values, the coefficient must be negative. If the threshold is to be corrected for higher values, the coefficient to be parameterized must be positive. For further reference, the hysteresis is indicated as a percentage of the parameterized twilight value. The following figure illustrates different examples of parametrization:

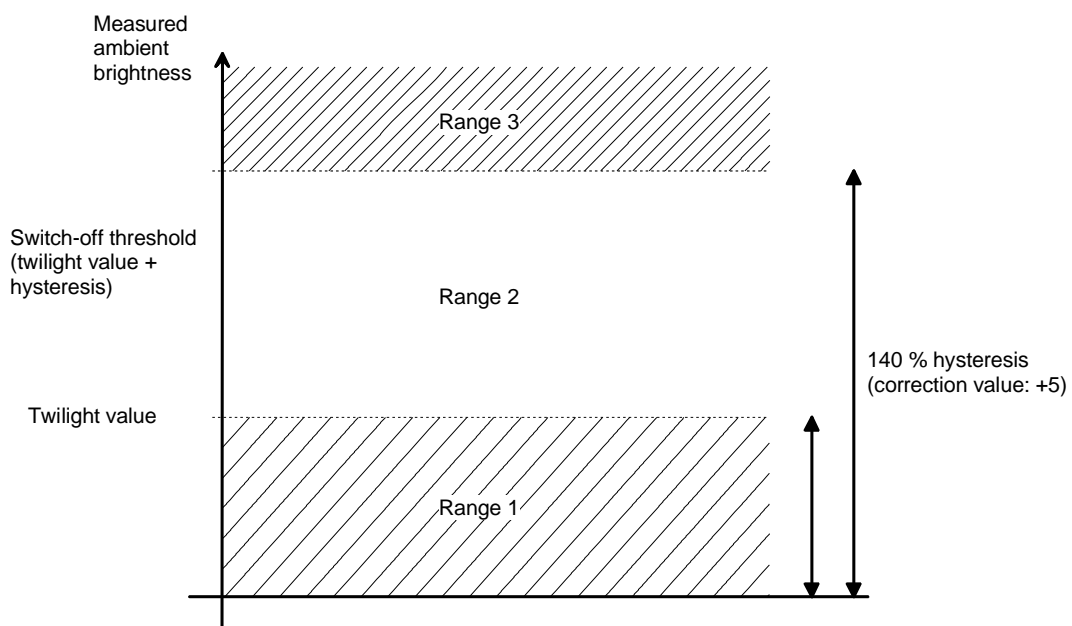
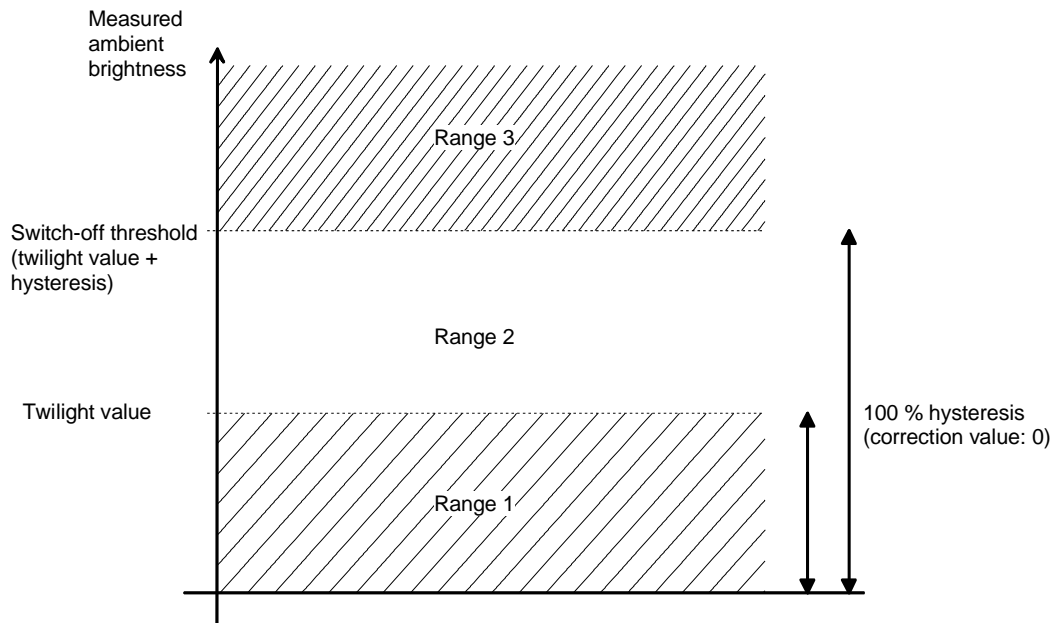



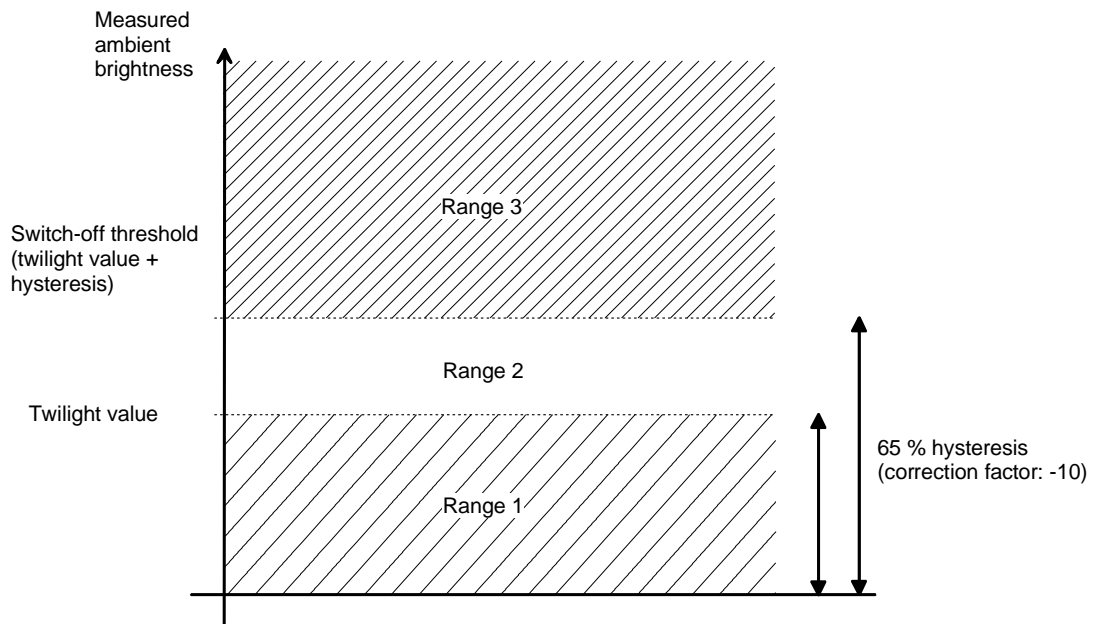

### Signalling mode

In the signalling mode, the device responds with 'reduced sensitivity' to detected movements as a signalling telegram (function 'signalling') is transmitted via the output object only after repeated sampling of the movement signal.

The criterion for triggering a signalling telegram is a parametrizable number of movement pulses  $X$  occurring within a preselected monitoring time span. A signalling telegram can then be transmitted at the beginning or at the end of detection (of an identified movement).

It is possible to parametrize the outputs provided for signalling with the functions "switching", "dimming value transmitter", "lightscape extension unit", "temperature value transmitter" or "brightness value transmitter". Contrary to the 'presence detector' and 'ceiling detector' modes, a movement is detected in this case only after  $X$  movement pulses have been counted within the monitoring time and after the telegram at the beginning of detection has been transmitted. In this way, the evaluation of movements can, if needed, be 'debounced' for these functions, too.

For the rest, the outputs assigned to the functions just mentioned behave as in the 'ceiling detector mode' i.e. a twilight level can be adjusted and an additional transmit delay be parameterized.

### Important:

In the signalling mode, a system configuration consisting of main units and extension units for all available functions does not exist anymore. Each device works independently and, after detection and evaluation of the movement, transmits a telegram via the output object to a central station. The extension inputs or outputs are deactivated in the signalling mode.

# instabus EIB System

## Sensor



The following diagrams show the behaviour of the device in the signalling mode and the 'Signalling' function with  $X = 4$  movement pulses parameterized in the ETS.

Case 1:  $x = 4$  movement pulses detected during monitoring period  $t_{\bar{u}}$  without telegram delay.

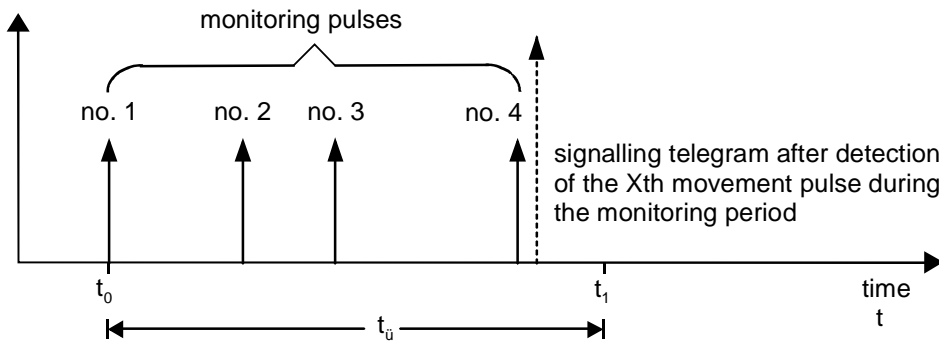

⇒ A signalling telegram as parameterized is transmitted at the beginning of detection after the 4th movement pulse ( $x = X$ ) has been detected during monitoring period  $t_{\bar{u}}$ .

Case 2:  $x = 3$  movement pulses detected during monitoring time  $t_{\bar{u}}$ .

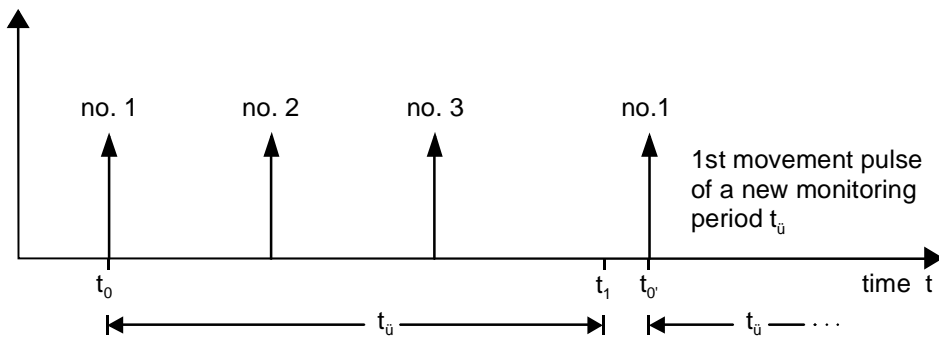

⇒ During the 1st monitoring time, only 3 movement pulses ( $x < X$ ) are detected and therefore no signalling telegram is transmitted. After the end of  $t_{\bar{u}}$  the next movement pulse is the first of a new monitoring period  $t_{\bar{u}}$ .

Case 3:  $x = 4$  movement pulses detected during monitoring period  $t_{\bar{u}}$  with telegram delay.

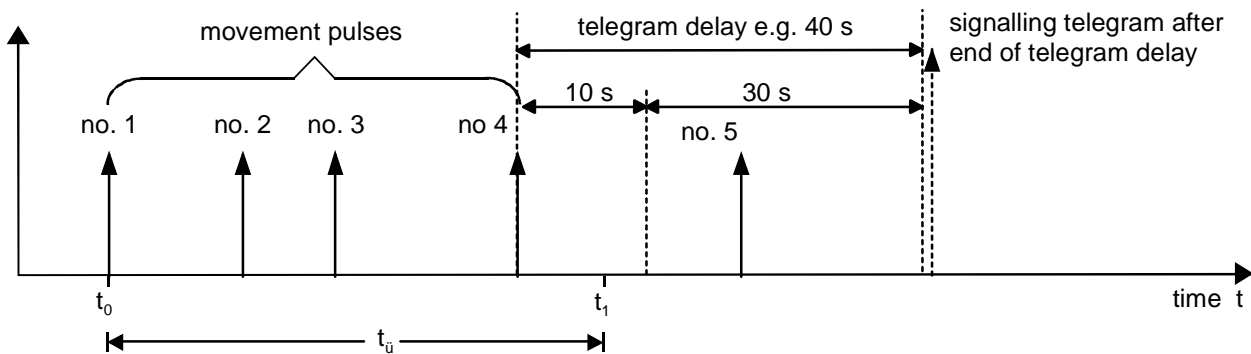

⇒ After detection of the 4th movement pulse ( $x = X$ ) during monitoring period  $t_{\bar{u}}$  the telegram delay is started. Within 30 seconds before this time ends, at least one new movement signal (no. 5) must be detected if the the signalling telegram at the beginning of detection is to be transmitted as parameterized. The 5th movement pulse shown in the diagram does not start a new monitoring period.



Case 4:  $x = 4$  movement pulses detected during monitoring period  $t_{\bar{u}}$  with telegram delay.

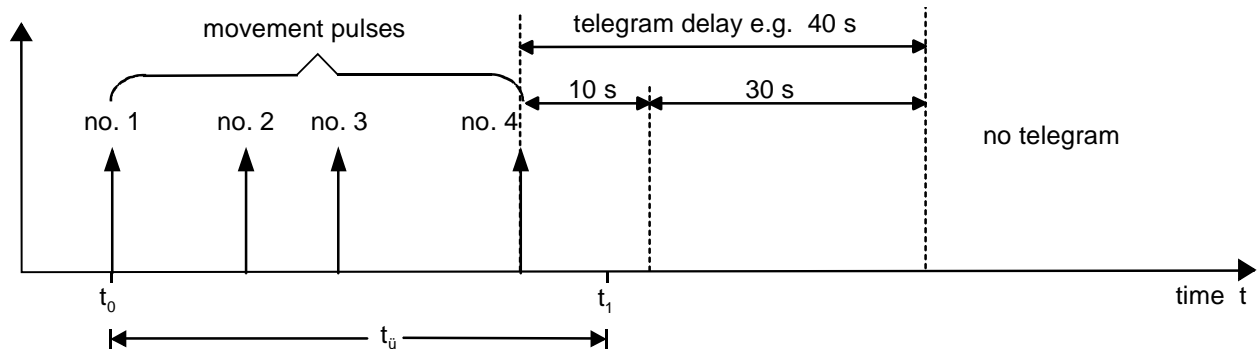

⇒ After detection of the 4th movement pulse ( $x = X$ ) during monitoring period  $t_{\bar{u}}$  the telegram delay is started. If, within 30 seconds before this time ends, not at least one new movement signal is detected, no telegram will be transmitted by the device.

Case 5: Signalling telegram at the end of detection without telegram delay.

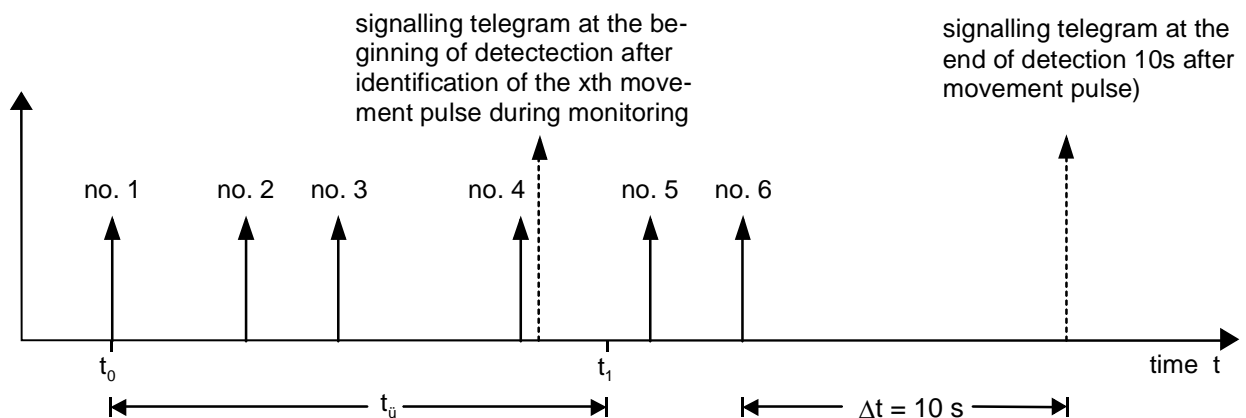

⇒ After detection of the 4th movement pulse ( $x = X$ ) during monitoring period  $t_{\bar{u}}$ , a signalling telegram at the beginning of detection will be transmitted as parameterized. At the end of detection (of the identified movement), the parameterized 'signalling telegram at the end of detection' will be transmitted. A detection is assumed to be terminated if, within the 10 seconds following the telegram at the beginning of detection, no movement pulses are detected anymore or if no further pulse has been detected within 10 seconds after the last movement signal has occurred.

# instabus EIB System

## Sensor



In the signalling mode (function 'Signalling'), the following functions are predefined:

- Twilight level:	brightness-independent
- Teach-in function:	inhibited
- Twilight level potentiometer:	inhibited
- Telegram delay:	possible
- Cyclic transmission during detection:	possible
- Telegram release on retriggering:	no function
- Additional transmit delay at the end of detection:	0 s
- 'Additional transmit delay' potentiometer:	inhibited
- Interlock at the end of detection:	0 s
- Inhibit function:	possible
- Extension unit inputs / outputs:	deactivated

In the signalling mode (functions: 'switching', 'dimming value transmitter', 'lightscape extension unit', 'temperature value transmitter' or 'brightness value transmitter'), the following functions are predefined:

- Twilight level:	parameterizable
- Teach-in function:	possible
- Twilight level potentiometer:	possible
- Telegram delay:	possible
- Cyclic transmission during detection:	possible
- Telegram release on retriggering:	possible
- Additional transmit delay at the end of detection:	parameterizable
- 'Additional transmit delay' potentiometer:	möglich
- Interlock at the end of detection:	parameterizable
- Inhibit function:	possible
- Extension unit inputs / outputs:	deactivated.

### Movement detection in the ceiling detector, presence detector or signalling modes (not function 'Signalling'):

A movement is understood here as the time comprising the first detection pulse plus the standard delay (10 s), starting with the last rising edge of the thermal movement plus the additional transmit delay. If parameterized, an additional telegram delay at the beginning of detection can be preset (cf. 'Telegram delay').

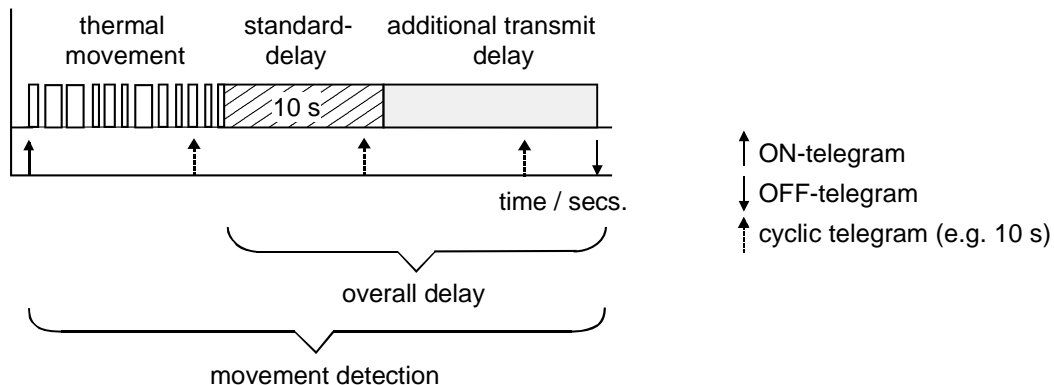

Telegrams can be transmitted at the beginning and at the end of movement detection. During movement detection, the output concerned operates always in the brightness-independent mode, i.e. it retriggers the overall delay independent of ambient brightness whenever a new movement is detected. Only if an OFF telegram or a value telegram "0" is transmitted after the end of detection via the output objects, does the output start the interlock period and switches over to brightness-dependent operation provided the twilight level is not set to brightness-independent operation.



If – at the end of detection – no OFF telegram or no value telegram "0" is transmitted, then the output is in the brightness-independent mode after detection of a movement. In this state, thermal movements are evaluated and – if a movement is detected – new movement evaluations started in the signalling mode after the X parameterized movement pulses have occurred. In this case, an OFF telegram or a value telegram "0" must be transmitted externally to the output objects after the end of detection so that the output can switch back to brightness-dependent operation. External telegrams to the output objects in the course of running movement evaluation have no influence on brightness control.

It must be remembered that a lightscape recall or a temperature value telegram at the end of a detection always works in the brightness-dependent mode if the twilight level is not set to brightness-independent. Special care must therefore be taken since there will be no more movement detections when the ambient brightness is permanently above the twilight level after a lightscape has been recalled. There may, however, be undesired movement detections if the brightness set by the recalled lightscape and the additional daylight-dependent ambient brightness is below the twilight level.

Depending on the telegrams transmitted, an output may also be in the brightness-independent state after return of bus voltage and during or after inhibiting.

#### **Combined action of outputs 1 and 2 or 3 and 4:**

It is possible that, due to differently parametrized delay times, outputs 1 and 2 or outputs 3 and 4 (depending on the preset mode of operation) transmit telegrams at different times and will therefore interlock each other.

The following example describes this behaviour:

If the interlock is started by output 1 (end of detection) and if output 2 is at this moment still engaged in active movement detection, then output 2 will be inhibited as well, i.e. it can no longer detect movements during the interlock. It is thus avoided that output 2 will be retriggered by the lamp switched off by output 1. When the interlock for output 1 has elapsed, output 2 can again detect new movements.

If the additional transmit delay of output 2 elapses within the interlock (end of detection by output 2), the interlock is restarted and both outputs are locked.

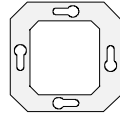

### Mode of operation change

With the mode-of-operation object it is possible to change between the two ETS-parameterized modes when the device is in operation. Before changing, the mode of operation hitherto active is brought into a defined fundamental state (as in the case of non-existing movement). There is always only one mode of operation active at the same time. The polarity of the mode-of-operation object can be parameterized. The mode change and thus the object and the second mode of operation can be enabled by the "mode-of-operation change" parameter.

The device can control two independent outputs in one mode of operation (mode 1: outputs 1 and 2; mode 2: outputs 3 and 4). Outputs 1 and 3 are always assigned to a mode of operation whereas outputs 2 and 4 can be activated in addition, if desired.

If a change-over request is being received via the object, the following cases will be considered depending on the parameterized change-over mode:

*"Change-over mode" = "after end of detection" (default):*

Case 1: At the time of mode-of-operation change-over it may be that both outputs of the mode hitherto active are neither engaged in movement detection, nor are any delay times active. In this case, the device changes over into the desired mode immediately after the change-over request.

Case 2: One output or both outputs of the actually set mode of operation are engaged in the detection of movements. Delay times have not yet been started. In this case, the existing mode is retained for the time being when a change-over request is received via the bus. Thereafter, a negative acknowledgement based on the mode-of-operation object is transmitted once and in form of the object value of the mode of operation hitherto active. The change-over request is stored in the device. After detecting a movement, the detector initiates the standard transmit delay (10 s). At this time, the mode of operation is not yet changed. The telegrams at the end of detection will only be transmitted after the overall transmit delay has elapsed. The device changes over to the desired mode only after both transmit delays have elapsed. In addition, the device transmits a positive acknowledgement via the mode-of-operation object in form of the object value of the newly set mode of operation.

In the signalling mode, a change-over request in the movement pulse counting phase during the monitoring time, i.e. before the telegram at the beginning of detection has been transmitted, will moreover be executed immediately.

Case 3: One output or both outputs of the actually set mode of operation are in the standard delay (10 s after the last movement), in the additional transmit delay or in an identified movement. In this case, too, the existing mode is retained for the time being when a change-over request is received via the bus and then a negative acknowledgement based on the mode-of-operation object transmitted once and in form of the object value of the mode of operation hitherto active. The change-over request is stored in the device. The telegrams at the end of detection will only be transmitted after the overall transmit delay has elapsed. The device changes over to the desired mode only after both transmit delays have elapsed. In addition, the device transmits a positive acknowledgement via the mode-of-operation object in form of the object value of the newly set mode of operation.

*"Change-over mode" = "at once":*

Immediately on receipt of the change-over request, the mode of operation hitherto active will always be terminated and any movement detections or delays in progress will be interrupted by transmission of the telegram(s) at the end of detection. The change into the desired mode is effected immediately thereafter.



### Important information on mode-of-operation change-over:

- If the mode of operation is to be changed during the inhibition of one or both outputs, the inhibit states are at first internally cancelled. Cancellation is always accompanied by the transmission of the telegrams at the end of detection parameterized for the output(s) irrespective of whether or not the outputs have been inhibited during the detection of movements. The mode of operation is changed immediately thereafter.  
During change-over to a 'new' mode of operation (e.g. mode 2), all inhibit functions are always internally deactivated without the values of the inhibit objects being updated. When changing back into the 'old' mode (e.g. mode 1), any inhibit functions previously interrupted by the change-over (in mode 1) are not re-executed.
- After return of the bus voltage, the active mode is always mode 1.
- Both outputs of a mode of operation must have terminated the movement evaluation before the mode of operation will be changed (only for "change-over mode" = "after end of detection").
- In a mode-of-operation change, the twilight level object will not be considered, i.e. the device will always change over to the brightness evaluation parameterized in the ETS or to the values learned from the teach-in function.

### Operation as main and extension unit

A main unit can be combined with any number of extension units with only the main unit transmitting switching, dimming, lightscape, temperature and brightness value telegrams and controlling the load.

### Evaluation of movements:

The units communicate with each other by means of the "movement" object:

If the main unit detects a movement directly, it transmits the parameterized telegram at the beginning of detection over the bus in order to inform the extension units about the movement detected, taking into account the local twilight level preset.

If one of the extension units detects a movement, it transmits to the main unit at regular intervals (cycle time = 9 s) the object value = 1 during the duration of the movement, taking into account the twilight levels preset at the extension units. The main unit in turn checks at regular intervals (cycle time = 10 s) whether it is receiving movement messages.

Two cases must be distinguished:

- *The evaluation of the twilight level is performed in the main unit and in the extension units (Parameter "Twilight level evaluation" = "main and extension unit" default):*

When the main unit receives a movement telegram from the main unit(s), the main unit always starts the movement evaluation and transmits the telegram at the beginning of detection independent of the twilight preset in the main unit.

- *The evaluation of the twilight level is performed only in the main unit (Parameter "Twilight level evaluation" = "main unit only"):*

When the main unit receives a movement telegram from the extension unit(s), the main unit first checks its own preset twilight level. Only if the ambient brightness at the main unit is inferior to the preset level does the main unit start the movement evaluation and transmit the telegram at the beginning of detection.

When the main unit itself does not detect movements anymore or when it does not receive movement telegrams anymore (which means that no more movements are detected at the extension unit) then the main unit stops the movement evaluation and transmits the telegram at the end of detection.

# instabus EIB System

## Sensor



### Twilight level control:

In addition to movement detection, the twilight level between the beginning of detection and the end of the additional transmit delay must be set for brightness-independent operation in the main unit as well as in the extension units. This ensures that the device can continue to detect movements even when the lights are switched on (retriggering).

The change-over to brightness-dependent or brightness-independent operation is effected in acc. with the parameterized function either directly via the output objects or via the "Twilight level" object. The main unit is now sending telegrams and can therefore switch the extension units into brightness-independent operation when a movement has been detected.

The polarity of the twilight level object is fixed and cannot be parameterized:

- Object "Twilight level" = "0"   ⇒ twilight level in acc. with parameter "Twilight level"
- Object "Twilight level" = "1"   ⇒ brightness-independent movement detection

A twilight level telegram will be transmitted also in those cases where the twilight level of the main unit is parameterized for brightness-independent operation. After changing the mode of operation via the "mode-of-operation" object or after return of bus voltage, the device is always switched over to the brightness evaluation parameterized in the ETS or the values learned from the teach-in function.

### Interlocking:

After a detection, the main unit and the extension unit(s) interlock each other during the parameterized interlock periods. The extension units recognize the end of movement detection when the main unit transmits a switching, dimming, lightscape extension, temperature or brightness value telegram at the end of detection and when no movement telegram is being received at the same time. If the main unit performs functions not known to the extension units (e.g. "Temperature value transmitter" or "Brightness value transmitter"), the end-of-movement detection is ensured by the twilight level object.

### Important:

- In main/extension unit operation, the objects "Output", "Movement" and "Twilight level" should be exchanged only between main unit and extension unit(s) or between main unit and load and not be transmitted to other bus subscribers to prevent malfunctions.
- In the "Signalling" mode of operation, the main/extension unit function is deactivated. In this case, each unit operates independently and generates the signalling telegrams, if necessary, directly as a function of a detected movement.
- In **main unit operation**, the presence detector works – as in stand-alone operation – in every mode of operation with up to 2 outputs. In all cases, however, only one output per mode is active (mode 1: output 1; mode 2: output 3) for the extension units connected to the device. Although the outputs 2 and 4 also respond to movement telegrams from the extension unit and start or stop a movement evaluation including telegram transmission at the beginning and end of detection, the control of the extension units via the output and twilight level objects is effected only via outputs 1 or 3. Only outputs 1 and 3 must therefore be connected to the extension units.
- In **extension unit operation**, the presence detector works in every mode with one output only (mode 1: output 1; mode 2: output 3). The output channels of the extension units must be connected to the corresponding output channels of the main unit. If extension units with only one mode of operation are used (e.g. flush-mounted detector 'Standard' or flush-mounted detector 'Komfort' without mode change facility), the output object of the extension unit should be connected to both output objects of modes 1 and 2 (output 1 and 3) of the main unit in order to be able to maintain the extension unit function in both modes in the event of a mode-of-operation change-over in the main unit.

As main/extension unit operation is also possible in combination with flush-mounted detectors 'Komfort' or with flush-mounted detectors 'Standard', and as the various functions (switching, dimming, lightscape extension, temperature and brightness value transmitter) rely on different conditions, the individual cases will be discussed on the following pages.





- 1) **Main unit:** Presence detector 'Komfort'  
**Extension unit:** Presence detector 'Komfort'

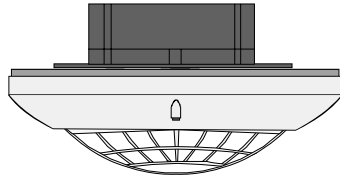

Main unit

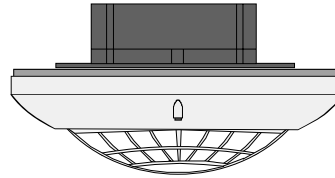

Extension unit

**Functions:** Switching / dimming / brightness value transmitter

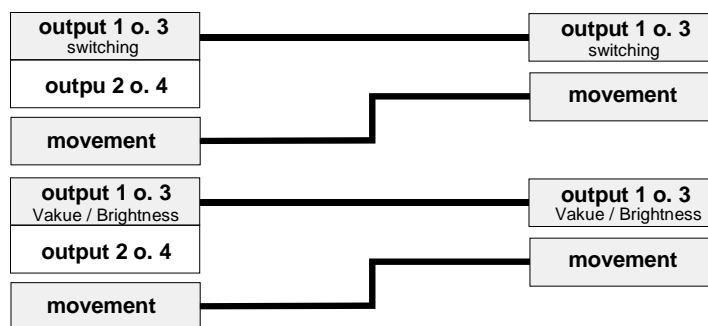

The twilight level of the extension units is switched on and off – unless parameterized for brightness-independent operation – by linking the output objects. An object value > 0 at the beginning of detection deactivates the twilight level (brightness-independent) and object value = 0 after the additional transmit delay has elapsed reactivates the twilight level (brightness-dependent).

Transmission of the twilight level via the twilight level object at the beginning of movement or after the additional transmit delay has elapsed is not required so that the transmission flag of the twilight level object can be deleted in the main unit.

A preset interlock will be started in the extension unit after the overall delay has elapsed by the arrival of the telegram at the end of detection and the non-arrival of the movement telegram.

**Functions:** Lightscape extension unit / temperature value transmitter

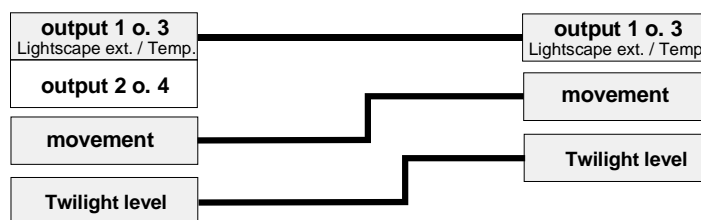

The twilight level of the extension units is switched on and off – unless parameterized for brightness-independent operation – by linking the twilight level objects, since the transmitted lightscape number permits no conclusion as to the brightness of the lamps controlled. At the beginning of detection, the main unit transmits twilight level value = 1 for brightness-independent detection. After passing of the additional transmit delay, twilight level value = 0 reactivates brightness-dependent movement evaluation in the extension units. If – after passing of the additional transmit delay – a lightscape is recalled which raises the actual ambient brightness in the room above the twilight level preset in the detector, the detector is no longer able to detect new movements. To avoid system design mistakes of this kind, special care must therefore be taken when presetting the lightscape recall function together with brightness-dependent movement detection (⇒ twilight level not parameterized to brightness-independent).

A preset interlock will be started in the extension unit by the arrival of the telegram signalling the end of detection and the non-arrival of the movement telegram after the overall delay has elapsed.

# instabus EIB System

## Sensor

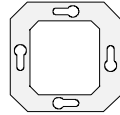

- 2) **Main unit:** Presence detector 'Komfort'
- Extension unit:** flush-mounted detector 'Komfort'

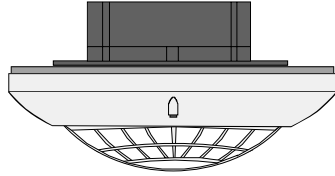

Main unit

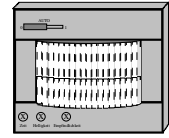

Extension unit

**Functions:** switching / dimming value transmitter

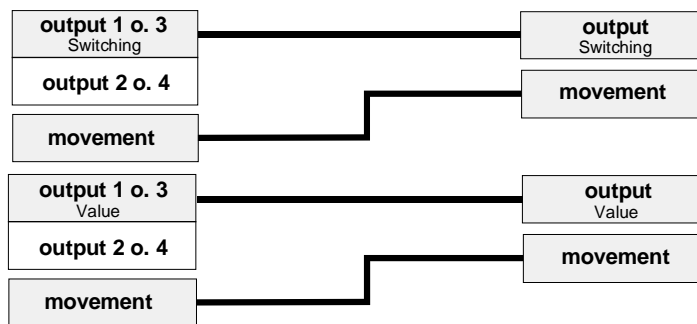

The twilight level of the extension units is switched on and off – unless parameterized for brightness-independent operation – by linking the output objects. An object value > 0 at the beginning of detection deactivates the twilight level (brightness-independent) and object value = 0 after the additional transmit delay has elapsed reactivates the twilight level (brightness-dependent).

Transmission of the twilight level via the twilight level object at the beginning of movement or after the additional transmit delay has elapsed is not required so that the transmission flag of the twilight level object can be deleted in the main unit.

A preset interlock will be started in the extension unit after the overall delay has elapsed by the arrival of the telegram at the end of detection and the non-arrival of the movement telegram.



**Function:** Lightscape extension unit

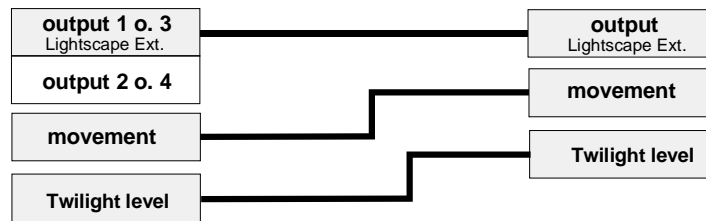

The twilight level of the extension units is switched on and off – unless parameterized for brightness-independent operation – by linking the twilight level objects, since the transmitted lightscape number permits no conclusion as to the brightness of the lamps controlled. At the beginning of detection, the main unit transmits twilight level value = 1 for brightness-independent detection. After passing of the additional transmit delay, twilight level value = 0 reactivates brightness-dependent movement evaluation in the extension units. If – after passing of the additional transmit delay – a lightscape is recalled which raises the actual ambient brightness in the room above the twilight level preset in the detector, the detector is no longer able to detect new movements. To avoid system design mistakes of this kind, special care must therefore be taken when presetting the lightscape recall function together with brightness-dependent movement detection (⇒ twilight level not parameterized for brightness-independent operation). A preset interlock will be started in the extension unit by the arrival of the telegram signalling the end of detection and the non-arrival of the movement telegram after the overall delay has elapsed.

**Functions:** Temperature / brightness value transmitter

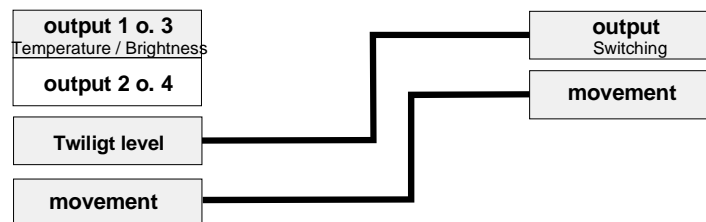

The flush-mounted detector 'Komfort' does not have the functions "temperature value transmitter" and "brightness value transmitter". For this reason, the detector – if used as an extension to the presence detector with the above functions – must be parameterized for the "switching" function. Output object "switching" of the detector must then be linked with the twilight level object of the presence detector. The twilight level of the extensions – if not parameterized for brightness-independent operation – is switched on and off via this link.

At the beginning of detection, the main unit transmits twilight level value = 1 for brightness-independent detection. After passing of the additional transmit delay, twilight level value = 0 reactivates brightness-dependent movement evaluation in the extension units. If – in the event of a lightscape recall or brightness value transmission, e.g. in conjunction with constant lighting control – a lightscape or a value is recalled after passing of the additional transmit delay which raises the actual ambient brightness in the room above the twilight level preset in the detector, the detector is no longer able to detect new movements. To avoid system design mistakes of this kind, special care must therefore be taken when presetting the lightscape recall function together with brightness-dependent movement detection (⇒ twilight level not parameterized for brightness-independent operation).

A preset interlock will be started in the extension unit by the arrival of the telegram signalling the end of detection and the non-arrival of the movement telegram after the overall delay has elapsed.

# instabus EIB System

## Sensor

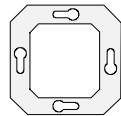

- 3) **Main unit:** Presence detector 'Komfort'  
**Extension unit:** flush-mounted detector 'Standard'

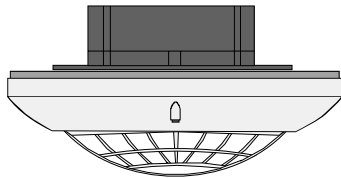

Main unit

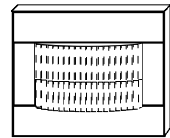

Extension unit

**Function:** Switching

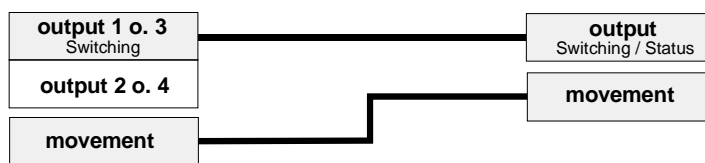

The twilight level of the extension units is switched on and off – unless parameterized for brightness-independent operation – by linking the output objects. An object value = 1 at the beginning of detection deactivates the twilight level (brightness-independent) and object value = 0 after the additional transmit delay has elapsed reactivates the twilight level (brightness-dependent).

Transmission of the twilight level via the twilight level object at the beginning of movement or after the additional transmit delay has elapsed is not required so that the transmission flag of the twilight level object can be deleted in the main unit.

A preset interlock will be started in the extension unit after the overall delay has elapsed by the arrival of the telegram at the end of detection and the non-arrival of the movement telegram.

**Functions:** dimming / lightscape extension / temperature / brightness value transmitter

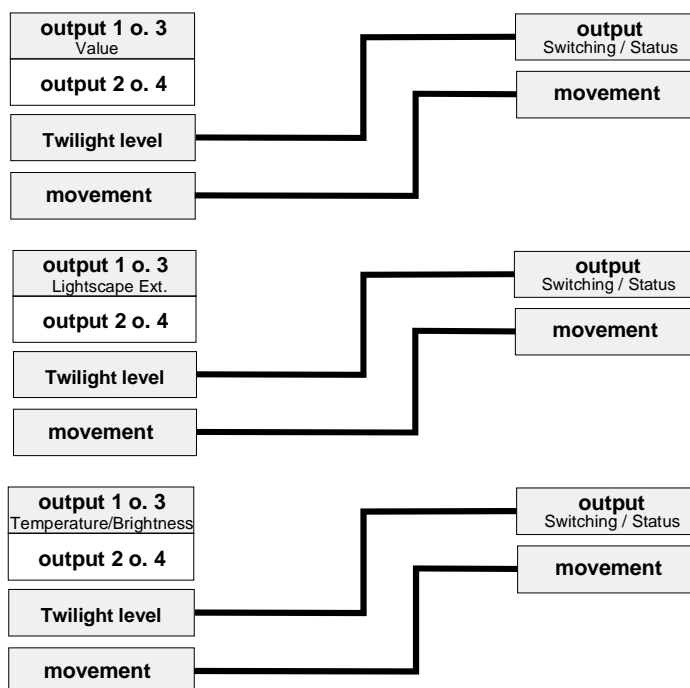



The flush-mounted detector 'Standard' does not have the functions "dimming value transmitter", "lightscape extension unit", "temperature value transmitter" and "brightness value transmitter". For this reason, the output object "Switching" of the detector – if used as an extension to the presence detector with the above functions – must then be linked with the twilight level object of the presence detector. The twilight level of the extensions – if not parameterized for brightness-independent operation – is switched on and off via this link.

At the beginning of detection, the main unit transmits twilight level value = 1 for brightness-independent detection. After passing of the additional transmit delay, twilight level value = 0 reactivates brightness-dependent movement evaluation in the extension units.

If – in the event of a lightscape recall or brightness value transmission, e.g. in conjunction with constant lighting control – a lightscape or a value is recalled after passing of the additional transmit delay which raises the actual ambient brightness in the room above the twilight level preset in the detector, the detector is no longer able to detect new movements. To avoid system design mistakes of this kind, special care must therefore be taken when presetting the lightscape recall function together with brightness-dependent movement detection (⇒ twilight level not parameterized for brightness-independent operation).

A preset interlock will be started in the extension unit by the arrival of the telegram signalling the end of detection and the non-arrival of the movement telegram after the overall delay has elapsed.

- 4) **Main unit:** Flush-mounted detector 'Komfort'  
**Extension unit:** presence detector 'Komfort'

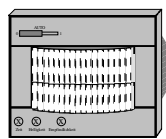

Main unit

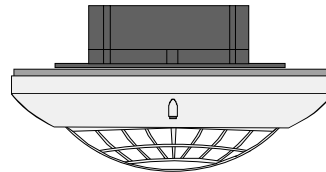

Extension unit

**Function:** Switching / dimming value transmitter

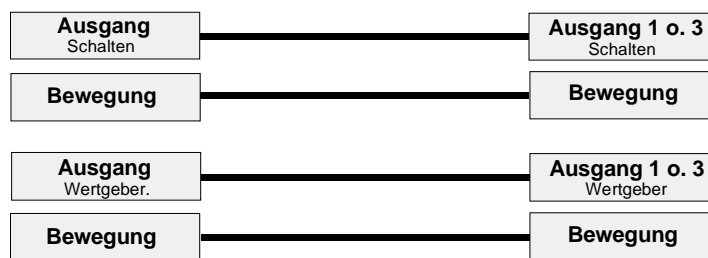

The twilight level of the extension units is switched on and off – unless parameterized for brightness-independent operation – by linking the output objects. An object value > 0 at the beginning of detection deactivates the twilight level (brightness-independent) and object value = 0 after the additional transmit delay has elapsed reactivates the twilight level (brightness-dependent).

Transmission of the twilight level via the twilight level object at the beginning of movement or after the additional transmit delay has elapsed is not required so that the transmission flag of the twilight level object can be deleted in the main unit.

A preset interlock will be started in the extension unit after the overall delay has elapsed by the arrival of the telegram at the end of detection and the non-arrival of the movement telegram

# instabus EIB System

## Sensor

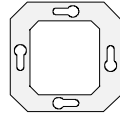

**Function:**           Lightscape extension unit

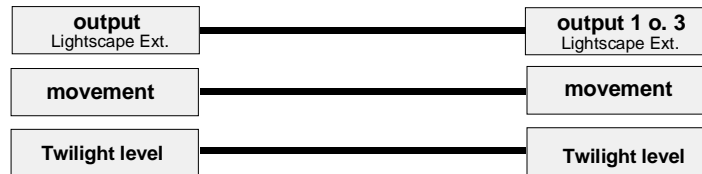

The twilight level of the extension units is switched on and off – unless parameterized for brightness-independent operation – by linking the twilight level objects, since the transmitted lightscape number permits no conclusion as to the brightness of the lamps controlled. At the beginning of detection, the main unit transmits twilight level value = 1 for brightness-independent detection. After passing of the additional transmit delay, twilight level value = 0 reactivates brightness-dependent movement evaluation in the extension units. If – after passing of the additional transmit delay – a lightscape is recalled which raises the actual ambient brightness in the room above the twilight level preset in the detector, the detector is no longer able to detect new movements. To avoid system design mistakes of this kind, special care must therefore be taken when presetting the lightscape recall function together with brightness-dependent movement detection (⇒ twilight level not parameterized for brightness-independent operation).

A preset interlock will be started in the extension unit by the arrival of the telegram signalling the end of detection and the non-arrival of the movement telegram after the overall delay has elapsed.



## Telegram delay at the beginning of detection

The telegram delay at the beginning of detection serves the purpose of preventing the device from responding to movements detected only during a very short time, as, for instance, a person rushing through a room. Movements are evaluated only if they last longer. Thereafter and if parametrized, the telegram signalling the beginning of detection is transmitted. The telegram delay function can be activated in all modes of operation.

When the first pulse of a new movement is detected, the parameterized telegram delay is started. Within a time slot of 30 seconds before the delay ends, the device checks whether there are still movements. If a movement is detected inside this time slot, the telegram at the beginning of detection is transmitted when the telegram delay has ended and the post-telegram delay (e.g. retriggering + standard delay 10 s + additional transmit delay) begins (Fig. 1).

If no further movement is detected within the time slot, no telegram will be transmitted after the end of the telegram delay and no movement evaluation takes place. A new movement which is detected thereafter restarts the parameterized telegram delay (Fig. 2).

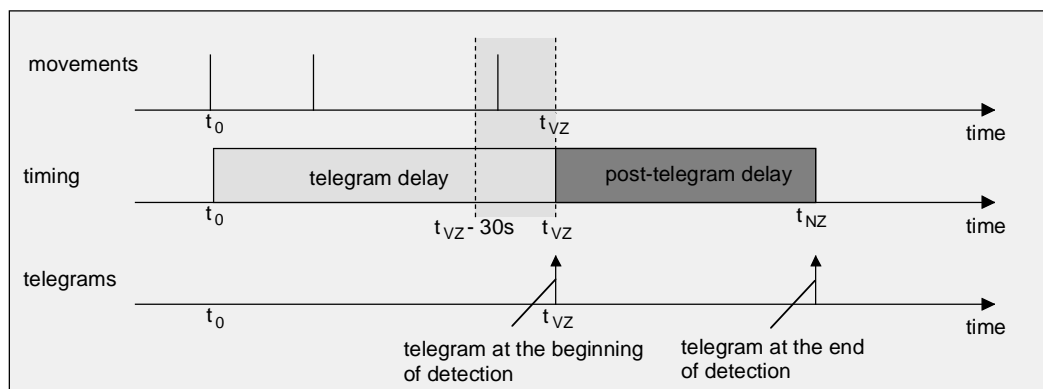

Fig. 1

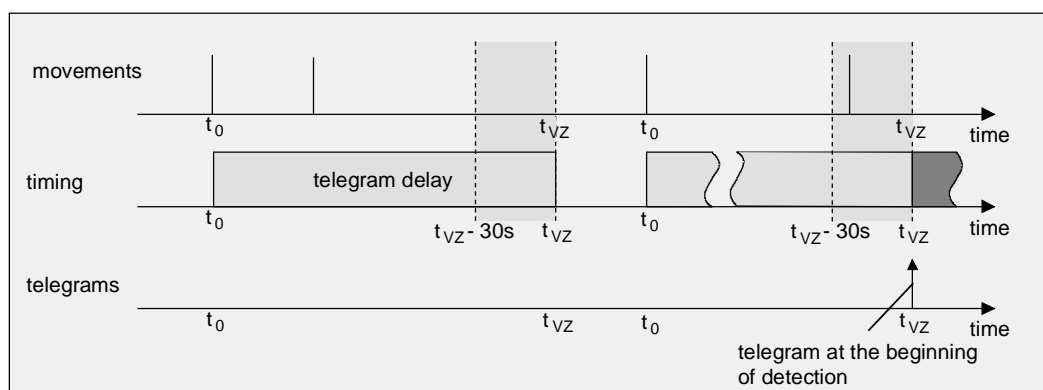

Fig. 2

$t_0$  : time of new movement detection (start of telegram delay)

$t_{VZ}$  : end of telegram delay

$t_{NZ}$  : end of post-telegram delay

If the telegram delay is parameterized with 30 s (minimum time / default), it starts with the first detected movement. Only if another movement is detected within this delay will the presence detector transmit the telegram at the beginning of detection.

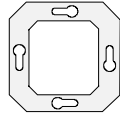

### Teach-in function

The teach-in function permits the direct, object-controlled and local adaptation of the twilight level (switch-on threshold) to existing ambient conditions. For this purpose, two teach-in objects are available that can be assigned to 2 outputs respectively.

In this case, the device adopts the actually measured ambient brightness as the new brightness level 3 s after an object update of the teach-in object. The 3 s delay permits the activation of further actuators in parallel with the telegram triggering the teach-in function for setting a different lighting situation before the new twilight level is stored.

In order to prevent actions of the presence detector (e.g. ON-, OFF-, value telegrams, cyclic transmission, inhibit telegrams. etc.) from influencing the brightness value within the 3 s delay, the presence and the movement evaluation or the brightness control are inhibited until the new twilight level has been adopted. A teach-in procedure during movement detection does not interrupt the adoption of this level.

The polarity of a teach-in telegram can be parameterised. Depending on parameterization, switching back to the originally parametrized setting of the twilight level is possible by transmitting the opposite object value (teach-in inactive). The twilight level previously learned is then lost. If the teach-in mode is parameterized for "1"- and "0" active, switching to the original twilight level programmed in the ETS is, however, no longer possible during normal operation. In this case, the original value can only be restored by reprogramming.

#### Important:

- Several subsequently received object updates for the teach-in object (teach-in active) cause the twilight level to be stored again every time an update is received.
- The twilight level learned by the teach-in function is permanently stored in the EEPROM of the bus coupler until a new teach-in telegram arrives so that a bus voltage failure does not in a loss of the value learned.
- When the twilight level is parameterized for brightness-independent operation, the teach-in function is deactivated.
- If a new twilight level has been preset by the teach-in function, then this value cannot be changed by the twilight level potentiometer.
- The inhibit function has no influence on the teach-in function.





## Inhibit function

Two independent inhibit objects are available for inhibiting individual outputs. One object can be assigned to each individual output.

At the beginning and at the end of inhibition, a telegram can be transmitted separately for each output with the functions parameterized for this output. After re-enabling the output(s), normal operation will be restored after the "telegram at the end of inhibition", i.e. movements will again be evaluated and movement telegrams from extension units again be executed.

### Important:

- In the event of an output being inhibited during presence detector operation, an active shut-off delay (10 minutes) will not be accomplished when the ambient brightness is above the shut-off threshold. The shut-off delay is reset at the beginning of the inhibition. After cancelling of the inhibition, the shut-off delay will be restarted if the ambient brightness continues to be above the shut-off threshold. The lighting is therefore shut off because of excessive brightness 10 minutes at the earliest after the inhibition has been cancelled.
- Movement telegrams from extension units during an activated inhibition of the main unit will be rejected. If desired, all extension units should be inhibited together with the main unit (by linking the inhibit objects).
- Each updating of the inhibit objects ("1" after "1" or "0" after "0") results in the transmission of the parameterized inhibit telegram at the beginning or at the end of the inhibition. Updates from "0" to "0" do not interrupt any movement evaluations in progress.
- The teach-in function is operational also during the inhibition of an output.

### Inhibit function and mode-of-operation change:

If the mode of operation is to be changed during the inhibition of one or two outputs, the inhibitions are at first immediately cancelled internally. In this case, the telegrams at the end of detection (!) parameterized for the corresponding output(s) will be transmitted irrespective of whether the outputs were inhibited during a movement detection or not. The mode of operation is then changed immediately thereafter.

A change-over into a 'new' mode of operation (e.g. mode 2) always deactivates internally all inhibit functions without updating the values of the inhibit objects. Changing back to the 'old' mode (e.g. mode 1) does not restart the inhibit functions previously interrupted (in mode 1).



# instabus EIB System

## Sensor



<b>Parameters</b>		
Description:	Values:	Comment:
 <b>Mode of operation</b>		
Type of application	<b>stand-alone operation</b>  main unit  extension unit	This parameter defines the type of application.
Mode-of-operation change (VZ)	enabled  <b>inhibited</b>	Changing between mode 1 and 2 via the mode-of-operation object is possible.  Modes of operation can be changed.  Modes of operation cannot be changed. Mode 2 is permanently deactivated.
Polarity of the mode-of-operation object for mode-of-operation change (VZ)	<b>0 = mode 1 / 1 = mode 2</b>  1 = mode 1 / 0 = mode 2	This parameter defines the polarity of the mode-of-operation object.  (only if "mode-of-operation change = enabled")
Change-over response	<b>after the end of detection</b>          immediate	The time when the device changes the mode of operation after a mode-of-operation change request can be defined.  If the device is detecting a movement when the request arrives, the movement detection continues until the movement has ended, i.e. the overall delay must elapse before the mode of operation is changed. If the device is not detecting a movement when the request arrives, the mode is changed immediately.  The mode of operation is changed immediately after a change-over request. If the device is detecting a movement, the telegram at the end of detection will be transmitted before change-over.
Mode of operation 1	<b>presence detector</b>  ceiling detector  signalling mode	This parameter defines mode of operation 1.



 Mode of operation		
Mode of operation 2 (VZ)	presence detector  <b>ceiling detector</b>  signalling mode	This parameter defines mode of operation 2.  (only if "mode-of-operation change = enabled")
Mode of operation 1 acts on (VZ)	<b>output 1</b>  outputs 1 and 2	This parameter defines whether mode 1 acts only on output 1 or on output 1 and 2.
Mode of operation 2 acts on (VZ)	<b>output 3</b>  outputs 3 and 4	This parameter defines whether mode 2 acts only on output 3 on output 3 and 4.  (only if "mode-of-operation change = enabled")
Sensitivity (for mode = detector / signalling operation) (VZ)	<b>high</b>  medium  low	The sensitivity of the PIR evaluation in the ceiling detector or signalling mode is adaptable.  The device also responds to shorter and weaker movement signals.  The device responds less sensitively to movement signals.  The device responds only to longer and stronger movement signals.
 General		
Function output 1	no function  <b>switching</b>  dimming value transmitter  lightscape extension  temperature value transmitter  brightness value transmitter  signalling *	This parameter defines the function of output 1.  *: "Signalling" only if "mode = signalling operation"
Function output 2 (VZ)	no function  <b>switching</b>  dimming value transmitter  lightscape extension  signalling *	This parameter defines the function of output 2.  *: "Signalling" only if "mode = signalling operation"  (only if "mode-of-operation change = enabled")



 General		
Function output 3 (VZ)	no function  <b>switching</b>  dimming value transmitter  lightscape extension  signalling *	This parameter defines the function of output 3.  *: "Signalling" only if "mode = signalling operation"  (only if "mode-of-operation change = enabled")
Function output 4 (VZ)	no function  <b>switching</b>  dimming value transmitter  lightscape extension  signalling *	This parameter defines the function of output 4.  *: "Signalling" only if "mode = signalling operation"  (only if "mode-of-operation change = enabled")
"Twilight level" potentiometer acts on	no output  <b>output 1</b>  output 2  output 3 **  output 4 **	This parameter defines the assignment of the "twilight level" potentiometer to the outputs.  **: (only if "mode-of-operation change = enabled")
Twilight level evaluation	<b>main and extension unit</b>           main unit only	The parameter defines the device in which the twilight level evaluation takes place.  The twilight level is evaluated in the main unit and in the extension unit. If the main unit receives a movement telegram from the extension unit(s), it will always start the movement evaluation and transmit the telegram at the beginning of detection independent of the twilight preset in the main unit.  The twilight level is evaluated only in the main unit. If the main unit receives a movement telegram from the extension unit(s), it will first check its own preset twilight level. Only if the ambient brightness at the main unit is inferior to the preset value, will the main unit start the evaluation of the movement and transmit the telegram at the beginning of detection.





General		
"Additional transmit delay" potentiometer acts on	no output output 1 output 2 output 3 ** output 4 **	This parameter defines the assignment of the "additional transmit delay" potentiometer to the outputs.  The overall delay before transmission of the telegram at the end of detection results from the addition of the standard delay (10 s) and the additional transmit delay.  **: (only if "mode-of-operation change = enabled")
Interlock after telegram release Basic values	8 ms <b>130 ms</b> 2.1 s 33 s	After the end of the overall delay, an interlock preventing the restart of consumers due to cooling can be activated. The presence detector restarts detecting movements only after the interlock period has elapsed.  Interlock period = basic value x factor
Interlock after telegram release, factor (0...255)	0...255 <b>(Default 23)</b>	Definition of time factor for the interlock period.  interlock period = basic value x factor  preset time: 130 ms · 23 = 2,99 s
Inhibit function, assignment (VZ)		
Enabling of inhibit object 1 (VZ)	enabled  <b>inhibited</b>	This parameter enables inhibit object 1.  The inhibit functions for outputs 1 and 3 can be activated only after inhibit object 1 has been enabled.
Polarity of inhibit object 1 (VZ)	<b>0 = enabled,</b> <b>1 = inhibited</b>  1 = enabled, 0 = inhibited	The inhibit function for outputs 1 and 3 is activated for an object value = 1.  The inhibit function for outputs 1 and 3 is activated for an object value = 0.
Assignment of inhibit object 1 to output 1 (VZ)	yes  <b>no</b>	Output 1 can be assigned to inhibit object 1.  Only if the assignment is set to "yes", will the functions parameterized on card "inhibit function, output 1" be executed.

# instabus EIB System

## Sensor



 Inhibit function, assignment (VZ)		
Assignment of inhibit object 1 to output 3 (VZ)	yes  <b>no</b>	Output 1 can be assigned to inhibit object 1.  Only if the assignment is set to "yes", will the functions parameterized on card "inhibit function, output 3" be executed.
Enabling of inhibit object 2 (VZ)	enabled  <b>inhibited</b>	This parameter enables inhibit object 2.  The inhibit functions for outputs 2 and 4 can be activated only after inhibit object 2 has been enabled.
Polarity of inhibit object 2 (VZ)	<b>0 = enabled, 1 = inhibited</b>  1 = enabled, 0 = inhibited	The inhibit function for outputs 2 and 4 is activated for an object value = 1.  The inhibit function for outputs 2 and 4 is activated for an object value = 0.
Assignment of inhibit object 2 to output 2 (VZ)	yes  <b>no</b>	Output 2 can be assigned to inhibit object 2  Only if the assignment is set to "yes", will the functions parameterized on card "inhibit function, output 2" be executed.
Assignment of inhibit object 2 to output 4 (VZ)	yes  <b>no</b>	Output 2 can be assigned to inhibit object 4.  Only if the assignment is set to "yes", will the functions parameterized on card "inhibit function, output 4" be executed.
 Teach-in, assignment (VZ)		
Enabling of teach-in object 1 (VZ)	enabled  <b>inhibited</b>	This parameter enables the teach-in object 1.  The teach-in functions for outputs 1 and 3 can be activated only after teach-in object 1 is enabled.



 Teach-in, assignment (VZ)		
Mode of operation teach-in object 1 (VZ)	<p>0 = active, 1 = inactive</p> <p><b>1 = active, 0 = inactive</b></p> <p>0 = active, 1 = active</p>	<p>This parameter defines the polarity of teach-in object 1.</p> <p>At an object value of "0", the teach-in function is active for outputs 1 and 3.</p> <p>At an object value of "1", the teach-in function is active for outputs 1 and 3.</p> <p>At an object value of "0" or "1", the teach-in function is active for outputs 1 and 3, i.e. a new brightness value is adopted at each object update.</p> <p>Only if "Enabling of teach-in object 1 = enabled"</p>
Assignment of teach-in object 1 to output 1 (VZ)	<p>yes</p> <p><b>no</b></p>	<p>Output 1 can be assigned to teach-in object1.</p> <p>The Teach-in function for output 1 will be executed only after the assignment is set to "yes".</p> <p>Only if twilight level is not brightness-independent.</p>
Assignment of teach-in object 1 to output 3 (VZ)	<p>yes</p> <p><b>no</b></p>	<p>Output 3 can be assigned to Teach-in object 1.</p> <p>The Teach-in function for output 3 will be executed only after the assignment is set to "yes".</p> <p>Only if twilight level is not brightness-independent.</p>
Enabling of teach-in object 2 (VZ)	<p>enabled</p> <p><b>inhibited</b></p>	<p>This parameter enables the Teach-in object 2.</p> <p>The Teach-in functions for outputs 2 and 4 can be activated only after Teach-in object 2 is enabled.</p>



Teach-in, assignment (VZ)		
Mode of operation teach-in object 2 (VZ)	<p>0 = active, 1 = inactive</p> <p><b>1 = active, 0 = inactive</b></p> <p>0 = active, 1 = active</p>	<p>This parameter defines the polarity of teach-in object 2.</p> <p>At an object value of "0", the teach-in function is active for outputs 2 and 4.</p> <p>At an object value of "1", the teach-in function is active for outputs 2 and 4.</p> <p>At an object value of "0" or "1", the teach-in function is active for outputs 2 and 4, i.e. a new brightness value is adopted at each object update.</p> <p>Only if "Enabling of teach-in object 2 = enabled"</p>
Assignment of teach-in object 2 to output 2 (VZ)	<p>yes</p> <p><b>no</b></p>	<p>Output 2 can be assigned to teach-in object 2.</p> <p>The teach-in function for output 2 will be executed only after the assignment is set to "yes".</p> <p>Only if twilight level is not brightness-independent.</p>
Assignment of teach-in object 2 to output 4 (VZ)	<p>yes</p> <p><b>no</b></p>	<p>Output 4 can be assigned to teach-in object 2.</p> <p>The teach-in function for output 4 will be executed only after the assignment is set to "yes".</p> <p>Only if twilight level is not brightness-independent.</p>
Evaluation of detection, output 1		
Send telegram at the beginning of detection?	<p><b>yes</b></p> <p>no</p>	<p>This parameter defines whether a telegram is to be transmitted at the beginning of detection.</p>
Telegram at the beginning of detection	<p><b>ON-telegram</b></p> <p>OFF-telegram</p>	<p>A switching telegram is transmitted at the beginning of detection.</p> <p>Only if function output 1 = "switching"</p>
Value at the beginning of detection (0...255)	<p>0 to 255 <b>(Default 255)</b></p>	<p>A value telegram is transmitted at the beginning of detection.</p> <p>Only if function output 1 = "dimming value transmitter"</p>
Lightscape number at the beginning of detection (1...64)	<p>1 to 64 <b>(Default 1)</b></p>	<p>A lightscape recall telegram is transmitted at the beginning of detection.</p> <p>Only if function output 1 = "lightscape extension"</p>





Evaluation of detection, output 1		
Temperature at the beginning of detection	0 °C to 40 °C <b>(Default 25 °C)</b> (in steps of 1 °C)	A temperature value telegram is transmitted at the beginning of detection. Only if function output 1 = "temperature value transmitter"
Brightness value at the beginning of detection	0 to 1500 lux <b>(Default 1000 lux)</b>	A brightness value telegram is transmitted at the beginning of detection. Only if function output 1 = "brightness value transmitter"!
Signalling telegram at the beginning of detection	<b>ON-telegram</b>  OFF-telegram	A signalling telegram is transmitted at the beginning of detection.  Only if mode of operation = signalling operation" and if "function output 1 = signalling"
Twilight level	<b>brightness-independent</b>  mode = "presence detector" range 100-300 lux <b>range 300-600 lux</b> range 600-1000lux  mode = "ceiling detector" range 10-30 lux <b>range 30-60 lux</b> range 60-100lux	Telegram triggering is brightness-independent (settings under "mode of operation = signalling operation")  When the lighting is off, telegrams will only be released if the brightness is below the preset value. This value is related to the range preset in the ETS and the assigned twilight level potentiometer as follows:  Potentiometer center position = medium value of ETS-adjusted range Potentiometer zero position = lower limit of ETS-adjusted range Potentiometer max. position = upper limit of ETS-adjusted range
Telegram delay? (VZ)	yes  <b>no</b>	A telegram delay can be programmed for a movement detection.  The telegram at the beginning of detection will be transmitted and the post-telegram delay started only after the telegram delay has elapsed and if movement continues to be detected.
Telegram delay basic value (VZ)	<b>1 s</b> 1,1 min 2,1 s      2,2 min 4,2 s      4,5 min 8,4 s      9 min 17 s      18 min 34 s      35 min	Time base for telegram delay.  Cyclical transmission = basic value x factor  (only if "telegram delay = yes")

# instabus EIB System

## Sensor

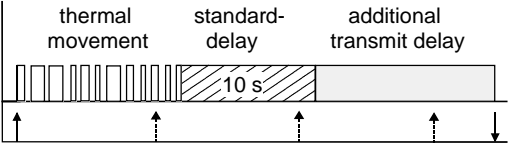

 Auswertung einer Erfassung, Ausgang 1		
Telegram delay factor (30...127) (VZ)	30 to 127 <b>(Default 30)</b>	Time factor for cyclic transmission.  Cyclic transmission = basic value x factor  Default setting: $1\text{ s} \cdot 30 = 30\text{ s}$  (only if "telegram delay = yes")
Cyclic transmission during detection? (VZ)	yes  <b>no</b>	Cyclic transmission during movement detection can be activated or deactivated. A movement is defined as the period ranging from the beginning of the first movement pulse plus the standard delay (10 s) starting at the last rising edge of the thermal movement and the additional transmit delay.   <p>↑ ON-telegram ↓ OFF-telegram ↑ cyclic telegram (e.g. 10 s)</p>
Cyclic transmission basic value (VZ)	<b>1 s</b> 1,1 min 2,1 s      2,2 min 4,2 s      4,5 min 8,4 s      9 min 17 s      18 min 34 s      35 min	Basic time for cyclic transmission.  Cyclic transmission = basic value x factor  (only if "cyclic transmission during detection = yes")
Cyclic transmission factor (10...127) (VZ)	10 to 127 <b>(Default 10)</b>	Time factor for cyclic transmission.  Cyclic transmission = basic value x factor  Default setting: $1\text{ s} \cdot 10 = 10\text{ s}$  (only if "cyclic transmission during detection = yes")
Telegram transmission on retriggering? (VZ)	<b>NO</b>  YES	Retriggering during the additional transmit delay can be with or without telegram. Only if "cyclic transmission = NO"



📁 End of detection, output 1		
Send telegram at the end of detection?	<b>yes</b> no	This parameter defines whether a telegram is to be transmitted at the end of detection.
Telegram at the end of detection	ON-telegram <b>OFF-telegram</b>	A switching telegram is transmitted at the end of detection. Only if function output 1 = "switching"
Value at the end of detection (0...255)	0 to 255 <b>(Default 0)</b>	A value telegram is transmitted at the end of detection. Only if function output 1 = "dimming value transmitter"
Lightscape number at the end of detection (1...64)	1 to 64 <b>(Default 1)</b>	A lightscape recall telegram is transmitted at the end of detection. Only if function output 1 = "lightscape extension"
Temperature at the end of detection	0 °C to 40 °C <b>(Default 18 °C)</b> (in steps of 1 °C)	A temperature value telegram is transmitted at the end of detection. Only if function output 1 = "temperature value transmitter"
Brightness value at the end of detection	0 to 1500 lux <b>(Default 300 lux)</b>	A brightness value telegram is transmitted at the end of detection. Only if function output 1 = "brightness value transmitter"
Signalling telegram at the end of detection	ON-telegram <b>OFF-telegram</b>	A signalling telegram is transmitted at the end of detection. Only if mode of operation = signalling operation" and if "function output 1 = signalling"
Additional transmit delay basic value (standard delay = 10 s)	<b>1 s</b> 2,1 s 4,2 s 8,4 s 17 s 34 s 1,1 min 2,2 min 4,5 min 9 min 18 min 35 min	<p>The overall delay is composed of the standard delay (10 s) and the additional transmit delay.</p> <p>Additional transmit delay = basic value x factor</p> <p><b>Important:</b> The smaller the number of movements expected the longer should the additional transmit delay be chosen.</p>

# instabus EIB System

## Sensor

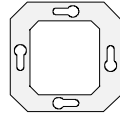

Ende der Erfassung, Ausgang 1		
Additional transmit delay factor (0...127)	0 to 127 <b>(Default 35)</b>	<p>Definition of time factor for additional transmit delay.</p> <p>Additional transmit delay = basic value x factor</p> <p>Default setting: 1 s · 35 = 35 s</p>
Shut-off hysteresis correction (+ = brighter, - = darker) (VZ)	-15 <b>0</b> +1 -14                            +2 -13                            +3 -12                            +4 -11                            +5 -10                            +6 -9                             +7 -8                             +8 -7                             +9 -6                            +10 -5                            +11 -4                            +12 -3                            +13 -2                            +14 -1                            +15	<p>The shut-off brightness can be adapted by means of the correction factor.</p> <p>After the twilight level (shut-off threshold) has been exceeded by the twice the preset value (100 %), the parameterized telegram at the end of detection will be transmitted after 10 minutes even if presence is still being detected.</p>
Inhibit function, output 1 (VZ)		
Send telegram at the beginning of inhibition? (VZ)	yes  <b>no</b>	This parameter defines whether a telegram is to be transmitted at the beginning of an inhibition.
Telegram at the beginning of inhibition (VZ)	ON-telegram  <b>OFF-telegram</b>	A switching telegram will be transmitted at the beginning of an inhibition. Only if function output 1 = "switching"
Value at the beginning of inhibition (0...255) (VZ)	0 to 255 <b>(Default 0)</b>	A value telegram will be transmitted at the beginning of an inhibition. Only if function output 1 = "dimming value transmitter"
Lightscape number at the beginning of inhibition (1...64) (VZ)	1 to 64 <b>(Default 1)</b>	A lightscape recall telegram is transmitted at the beginning of inhibition. Only if function output 1 = "lightscape extension"
Temperature at the beginning of inhibition (VZ)	0 °C to 40 °C <b>(Default 18 °C)</b> (in steps of 1 C)	A temperature value telegram is transmitted at the beginning of inhibition. Only if function output 1 = "temperature value transmitter"
Brightness value at the beginning of inhibition (VZ)	0 to 1500 lux <b>(Default 1000 lux)</b>	A brightness value telegram is transmitted at the beginning of inhibition. Only if function output 1 = "brightness value transmitter"



Inhibit function, output 1 (VZ)		
Signalling telegram at the beginning of inhibition (VZ)	ON-telegram  <b>OFF-telegram</b>	A signalling telegram is transmitted at the beginning of inhibition. Only if mode of operation = "signalling operation" and if "function output 1 = signalling"
Send telegram at the end of inhibition? (VZ)	yes  <b>no</b>	This parameter defines whether a telegram is to be transmitted at the end of an inhibition.
Telegram at the end of inhibition (VZ)	ON-telegram  <b>OFF-telegram</b>	A switching telegram is transmitted at the end of inhibition. Only if function output 1 = "switching"
Value at the end of inhibition (0...255) (VZ)	0 to 255 <b>(Default 0)</b>	A value telegram is transmitted at the end of inhibition. Only if function output 1 = "dimming value transmitter"
Lightscape number at the end of inhibition (1...64) (VZ)	1 to 64 <b>(Default 1)</b>	A lightscape recall telegram is transmitted at the end of inhibition. Only if function output 1 = "lightscape extension"
Temperature at the end of inhibition (VZ)	0 °C to 40 °C <b>(Default 18 °C)</b> (in steps of 1 °C)	A temperature value telegram is transmitted at the end of inhibition. Only if function output 1 = "temperature value transmitter"
Brightness value at the end of inhibition (VZ)	0 to 1500 lux <b>(Default 300 lux)</b>	A brightness value telegram is transmitted at the end of inhibition. Only if function output 1 = "brightness value transmitter"
Signalling telegram at the end of inhibition (VZ)	ON-telegram  <b>OFF-telegram</b>	A signalling telegram is transmitted at the end of inhibition. Only if mode of operation = "signalling operation" and if "function output 1 = signalling"
Evaluation of detection, output 2 see output 1, but without "temperature value transmitter" and "brightness value transmitter"		
Evaluation of detection, output 3 see output 1, but without "temperature value transmitter" and "brightness value transmitter"		
Evaluation of detection, output 4 see output 1, but without "temperature value transmitter" and "brightness value transmitter"		
End of detection, output 2 see output 1, but without "temperature value transmitter" and "brightness value transmitter"		
End of detection, output 3 see output 1, but without "temperature value transmitter" and "brightness value transmitter"		
End of detection, output 4 see output 1, but without "temperature value transmitter" and "brightness value transmitter"		
Inhibit function, output 2 see output 1, but without "temperature value transmitter" and "brightness value transmitter"		
Inhibit function, output 3 see output 1, but without "temperature value transmitter" and "brightness value transmitter"		
Inhibit function, output 4 see output 1, but without "temperature value transmitter" and "brightness value transmitter"!		

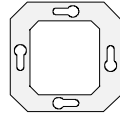

# instabus EIB System

## Sensor



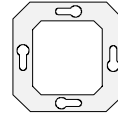

 Signalling operation				
Signalling operation monitoring period, basic value	130 ms 260 ms 520 ms <b>1 s</b> 2,1 s 4,2 s	8,4 s 17 s 34 s 1,1 min 2,2 min 4,5 min	9 min 18 min 36 min 1,2 h	A signalling telegram is transmitted if N movement pulses are registered within a fixed monitoring period.  Monitoring time = basic value x factor
Signalling operation monitoring period, factor (1...127)	1...127 <b>(Default 10)</b>			A signalling telegram is transmitted if N movement pulses are registered within a fixed monitoring period.  Monitoring time = basic value x factor  Voreinstellung: 1 s · 10 = 10 s
Number of movements during the monitoring period (1...255)	1...255 <b>(Default 4)</b>			A signalling telegram is transmitted if N movement pulses are registered within a fixed monitoring period.
Signalling operation assignment of output 1	yes    no			When one of the modes of operation is parametrized for "signalling operation", the outputs reserved for this mode are assigned to the monitoring period.  Output 1 is assigned to the monitoring period.  Output 1 is not assigned to the monitoring period.
Signalling operation assignment of output 2	yes    no			When one of the modes of operation is parametrized for "signalling operation", the outputs reserved for this mode are assigned to the monitoring period.  Output 2 is assigned to the monitoring period.  Output 2 is not assigned to the monitoring period.
Signalling operation assignment of output 3	yes    no			When one of the modes of operation is parametrized for "signalling operation", the outputs reserved for this mode are assigned to the monitoring period.  Output 3 is assigned to the monitoring period.  Output 3 is not assigned to the monitoring period.

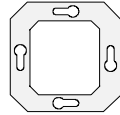

 Signalling operation		
Signalling operation assignment of output 4	yes  no	<p>When one of the modes of operation is parametrized for "signalling operation", the outputs reserved for this mode are assigned to the monitoring period.</p> <p>Output 4 is assigned to the monitoring period.</p> <p>Output 4 is not assigned to the monitoring period.</p>
 Alarm function		
Alarm function	enabled  <b>inhibited</b>	This parameter can enable the alarm function.
Data format of alarm object	<b>1 bit</b>  1 byte	This parameter defines the data format of the alarm object.
Command after removal of module	<b>ON-telegram</b>  OFF-telegram	In the event of an alarm message, a switching telegram will be transmitted. Only with "data format = 1 bit"
Value after removal of module (1...255)	1 to 255 <b>(Default 1)</b>	<p>In the event of an alarm message, a value telegram will be transmitted Only with "data format = 1 byte"!</p> <p>The value for resetting of the alarm message (enable telegram) is "0" Only required when "automatic reset of sabotage = NO"</p>
Transmit delay, basic value	8 ms <b>130 ms</b> 2.1 s 33 s	<p>In the event of module removal, the alarm telegram will be transmitted after the transmit delay has elapsed.</p> <p>Transmit delay = basic value x factor</p>
Transmit delay Factor (1...255)	1 to 255 <b>(Default 3)</b>	<p>Definition of time factor for the transmit delay.</p> <p>Transmit delay = basic value x factor</p> <p>Default setting: 130 ms · 3 = 390 ms</p>



 Alarm function		
Automatic reset of alarm message?	<p><b>yes</b></p> <p>no</p>	<p>This parameter defines whether the alarm message is to be reset automatically after the module has been plugged in again.</p> <p>An inverted alarm telegram (1 bit) or a telegram with the value = 0 (1 byte) will be transmitted and the device re-enabled (device functional).</p> <p>To enable the device, an enable telegram (inverted alarm telegram for 1 bit or a telegram with the value = 0 for 1 byte) must be transmitted to the alarm object with the module plugged in.</p>
 Bus voltage return		
Output 1: Send telegram on return of bus voltage?	<p>yes</p> <p><b>no</b></p>	This parameter defines whether a telegram is to be transmitted on return of bus voltage.
Telegram on return of bus voltage	<p><b>ON-telegram</b></p> <p>OFF-telegram</p>	A switching telegram is transmitted on return of bus voltage. Only if function output 1 = "switching"
Value on return of bus voltage (0...255)	0 to 255 <b>(Default 0)</b>	A value telegram is transmitted on return of bus voltage. Only if function output 1 = "dimming value transmitter"
Lightscape number on return of bus voltage (1...64)	1 to 64 <b>(Default 1)</b>	A lightscape recall telegram is transmitted on return of bus voltage. Only if function output 1 = "lightscape extension"
Temperature on return of bus voltage (VZ)	0 °C to 40 °C <b>(Default 18 °C)</b> (in steps of 1 °C)	A temperature value telegram is transmitted on return of bus voltage. Only if function output 1 = "temperature value transmitter"
Brightness value on return of bus voltage (VZ)	0 to 1500 lux <b>(Default 300 lux)</b>	A brightness value telegram is transmitted on return of bus voltage. Only if function output 1 = "brightness value transmitter"
Signalling telegram on return of bus voltage (VZ)	<p><b>ON-telegram</b></p> <p>OFF-telegram</p>	A signalling telegram is transmitted on return of bus voltage. Only if mode of operation = "signalling operation" and if "function output 1 = signalling".



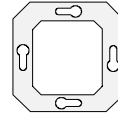

## Sensor

 Bus voltage return		
Output 2: Send telegram on return of bus voltage?	yes <b>no</b>	This parameter defines whether a telegram is to be transmitted on return of bus voltage.
Telegram on return of bus voltage	<b>ON-telegram</b> OFF-telegram	A switching telegram is transmitted on return of bus voltage. Only if function output 2 = "switching"
Value on return of bus voltage (0...255)	0 to 255 <b>(Default 0)</b>	A value telegram is transmitted on return of bus voltage. Only if function output 2 = "dimming value transmitter"
Lightscape number on return of bus voltage (1...64)	1 to 64 <b>(Default 1)</b>	A lightscape recall telegram is transmitted on return of bus voltage. Only if function output 2 = "lightscape extension"
Signalling telegram on return of bus voltage (VZ)	<b>ON-telegram</b> OFF-telegram	A signalling telegram is transmitted on return of bus voltage. Only if mode of operation = signalling operation" and if "function output 2 = signalling".
Output 3: Send telegram on return of bus voltage?	yes <b>no</b>	This parameter defines whether a telegram is to be transmitted on return of bus voltage.
Telegram on return of bus voltage	<b>ON-telegram</b> OFF-telegram	A switching telegram is transmitted on return of bus voltage. Only if function output 3 = "switching"
Value on return of bus voltage (0...255)	0 to 255 <b>(Default 0)</b>	A value telegram is transmitted on return of bus voltage. Only if function output 3 = "dimming value transmitter"
Lightscape number on return of bus voltage (1...64)	1 to 64 <b>(Default 1)</b>	A lightscape recall telegram is transmitted on return of bus voltage. Only if function output 3 = "lightscape extension"
Signalling telegram on return of bus voltage (VZ)	<b>ON-telegram</b> OFF-telegram	A signalling telegram is transmitted on return of bus voltage. Only if mode of operation = signalling operation" and if "function output 3 = signalling".
Output 4: Send telegram on return of bus voltage?	yes <b>no</b>	This parameter defines whether a telegram is to be transmitted on return of bus voltage.

# instabus EIB System

## Sensor



Bus voltage return		
Telegram on return of bus voltage	<b>ON-telegram</b> OFF-telegram	A switching telegram is transmitted on return of bus voltage. Only if function output 4 = "switching"
Value on return of bus voltage (0...255)	0 to 255 <b>(Default 0)</b>	A value telegram is transmitted on return of bus voltage. Only if function output 4 = "dimming value transmitter"
Lightscape number on return of bus voltage (1...64)	1 to 64 <b>(Default 1)</b>	A lightscape recall telegram is transmitted on return of bus voltage. Only if function output 4 = "lightscape extension"
Signalling telegram on return of bus voltage (VZ)	<b>ON-telegram</b> OFF-telegram	A signalling telegram is transmitted on return of bus voltage. Only if mode of operation = signalling operation" and if "function output 4 = signalling".

## Software comments

### • Bus voltage failure / bus voltage return

#### Bus voltage failure:

In the event of bus voltage failure there is no reaction from the device. Active movement detections or running delays or inhibit functions are rejected and not continued on return of bus voltage.

#### Bus voltage return:

On return of bus voltage or after reinsertion of the module, telegrams can be transmitted optionally for each output in order to restore a defined state.

When re-inserting the module, an alarm function – if parameterized – must be observed. In this case, the telegrams on return of bus voltage are transmitted only after the device is externally enabled in the event of non-automatic reset of the sabotage condition.

After programming of the device with the ETS, no telegrams will be transmitted on return of bus voltage.

It must be ensured that in the event of a telegram after return of bus voltage having a value > 0 for the functions: "switching", "dimming value transmitter" and "brightness value transmitter", the corresponding outputs must be in the brightness-independent mode. In this case the device assumes that the load or the lighting is on as is the case with movement detection.

#### **Important:**

- The twilight level learned from the teach-in function will be stored permanently in the EEPROM of the bus coupler until a new teach-in telegram is received so that a bus voltage failure cannot cause loss of the value learned.
- After return of bus voltage it is always mode of operation 1 that is active.
- In extension operation, no telegrams will be issued after return of bus voltage.



- **"Twilight level" potentiometer**

With the lights off and a twilight level set to not brightness-independent, telegrams are issued only when the brightness is below the set value. This value results from the range set with the ETS and the assigned twilight level potentiometer as follows:

Center position of potentiometer = medium value of the ETS-adjusted range

Minimum position of potentiometer = lower limit of the ETS-adjusted range

Maximum position of potentiometer = upper limit of the ETS-adjusted range

The twilight level potentiometer can only act on one of up to four outputs.

The twilight level potentiometer can be inhibited by means of the "Twilight level potentiometer acting on" parameter (setting: "no output"). When the potentiometer is inhibited, the medium value of the brightness range as set by the "Twilight level" parameter is applicable per output.

Two different reactions of the device must be distinguished:

1. The twilight level potentiometer was initially enabled for fine-tuning of the twilight level for an output and then inhibited in the ETS.  
The setting performed with the twilight potentiometer for the assigned output remains valid after activated potentiometer inhibition, and this even after bus voltage failure and after removal and re-insertion of the module. The twilight level set by the potentiometer and the output assigned are permanently stored in the EEPROM of the BCU at the beginning of potentiometer inhibition.  
If the twilight level potentiometer is then enabled once again for the previously fine-tuned output, the old potentiometer setting for this output will be replaced in the BCU by the new values in the event of another subsequent inhibition.  
As always the value of only one output can be stored after potentiometer inhibition, it is not possible to achieve permanent fine-tuning of several outputs in this way.
2. The twilight level potentiometer was always inhibited.  
The corresponding value for the preset twilight level (per output) is the medium value of the brightness range defined by means of the ETS parameter "Twilight level".

The condition of the device in which the twilight level potentiometer was always inhibited (condition 2. / default), can be restored by reprogramming the bus coupler with the ETS and the parameter setting "no output". Programming must then be done with the module not inserted (reset in the module).

- **"Additional transmit delay" potentiometer**

The "additional transmit delay" potentiometer permits continuous variation of the additional transmit delay duration by  $\pm 50\%$  with respect to the value parameterized in the ETS.

The delay duration set with the potentiometer is as follows:

Center position of potentiometer = ETS-adjusted value

Minimum position of potentiometer = - 50 % of the ETS-adjusted value

Maximum position of potentiometer = + 50 % of the ETS-adjusted value

The potentiometer can be inhibited by means of the parameter "Additional transmit delay potentiometer acting on". If the potentiometer is inhibited, the applicable delay per output is the one adjusted with the "additional transmit delay" parameter".